

instructions

DeLonghi

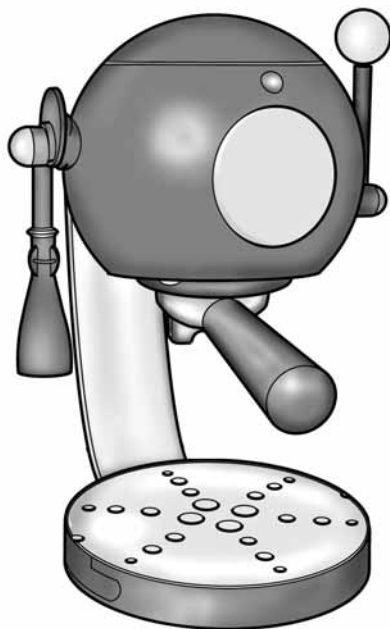

CAPPUCCINO AND ESPRESSO COFFEE MAKER

EC11

DeLonghi

Living innovation

Description of Appliance

The following terms are used throughout the instruction manual

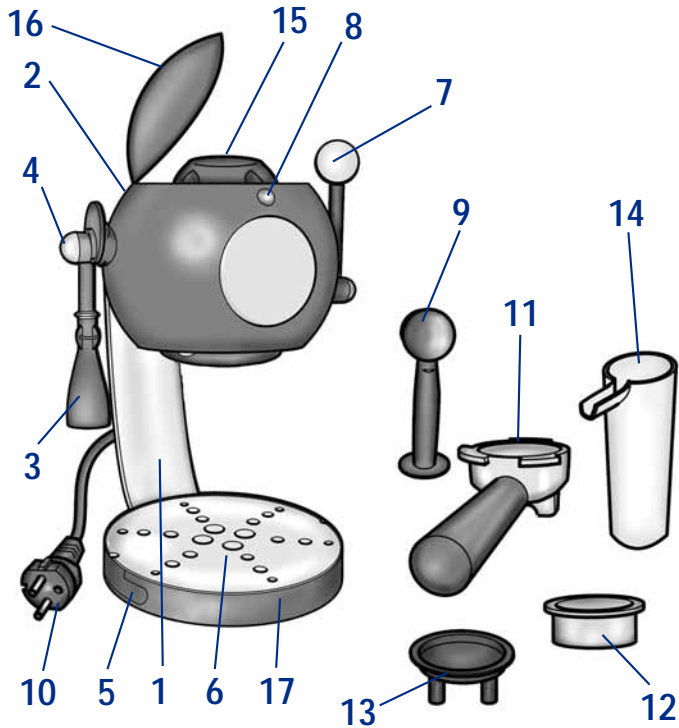

COMPONENTS AND CONTROLS

- | | |
|---------------------------------------|----------------------------|
| 1. Steel bar | 10. Power cord and plug |
| 2. Boiler tank | 11. Filter holder |
| 3. MAXI CAPPUCCINO device | 12. Thermocream® filter |
| 4. Steam dispenser button | 13. Thermocream® plate |
| 5. Removable drip tray | 14. Water measure |
| 6. Removable cup grille | 15. Boiler tank safety cap |
| 7. Pre-heat/power lever | 16. Appliance lid |
| 8. Boiler temperature indicator light | 17. Base |
| 9. Coffee measure/presser | |

IMPORTANT WARNINGS

Read these instructions carefully

The necessary precautions must be taken when using electrical appliances, including the following:

- The appliance is equipped with thermostats and safety cap; these have been made in compliance with European regulations governing domestic appliances.
- Before connecting the appliance to the power source, make sure that the voltage on the rating plate located on the bottom of the machine corresponds to that of the power source.
- This appliance is for home use only and should not be used for commercial or industrial purposes.
- Always connect the appliance to a grounded plug socket.
- Never leave the appliance within the reach of children or people unable to properly operate it.
- Never leave the appliance exposed to the elements (rain, sun, etc.).
- Always place the appliance on a flat, level surface during use.
- If the appliance is to remain unused for a long period, it is advisable to unplug it from the power source.
- To prevent damage to the appliance, never use it without water in the boiler tank.
- The power cord must not come into contact with the hot surfaces of the appliance.
- Never place the appliance on or close to sources of heat.
- Always unplug the appliance before carrying out any cleaning or maintenance.
- The use of extension leads other than those authorised by the appliance manufacturer could cause damage or accidents.
- Never direct the steam jet towards body parts; always handle the steam nozzle with care: risk of scalding!
- Always unplug the appliance from the power source before filling the boiler tank.
- **Before opening the safety cap, and before refilling the boiler tank, make sure that there is no residual steam still under pressure in the tank, by pressing the steam dispenser button.**
- Never use the appliance if the boiler tank cap is not correctly inserted.
- Only start the appliance once the boiler tank has been filled to the maximum level, otherwise the water will not reach the pressure required to dispense the coffee.
- Never leave the appliance in ambient temperatures of less than 0°C, since any water left in the boiler tank could freeze, damaging the appliance.

- Never touch the filter clip and the cappuccino maker tube when the appliance is operating, as this could cause scalding.
- Never use sparkling (carbonated) water.
- Do not wash attachments in a dishwasher.
- Never add de-scaling, aromatic, alcohol-based or cleansing products to the inside of the appliance as they could cause damage.
- In the event of failures, faults, defects or suspected defects subsequent to a fall, unplug the appliance immediately. Never use a faulty appliance. REPAIRS MAY ONLY BE CARRIED OUT AT AN AUTHORISED ASSISTANCE CENTRE. No liability will be accepted for damage caused by incorrectly performed repairs..
- To prevent any risks, if the power cord is damaged it must be replaced by the manufacturer, its Technical Assistance Service, or a similarly qualified person.
- After first unplugging the appliance and leaving it to cool, clean it only with a non-abrasive, slightly damp cloth and a few drops of a mild, non-aggressive, detergent (never use solvents that could damage the paintwork). NEVER PLACE THE APPLIANCE IN WATER OR OTHER LIQUIDS.
- In the event that you decide to dispose of the appliance, we advise you to make it inoperative by cutting off the power cord. We also recommend that any parts that could be dangerous, especially for children - who may play with the appliance or its parts, be rendered harmless.
- Packaging must never be left within the reach of children as it is potentially dangerous.

PLEASE RETAIN THESE INSTRUCTIONS

De'Longhi coffee machines are ideal for those who enjoy savouring life's pleasures, starting with a good cup of coffee. Thanks to its Thermocream® device, you can now enjoy a hot, creamy cup of coffee like the ones served in bars in the comfort of your own home. In fact, the Thermocream® device is formed by a filter, with a hole in the centre to ensure coffee is dispensed at high pressure, and a plate. This way it is possible to savour a really creamy coffee with an intense aroma and a full-bodied flavour. This is possible without needing to press the coffee down firmly and using any type of blend, as long as it is not too finely ground. De'Longhi coffee machines also cater to cappuccino lovers because, thanks to the MAXI CAPPUCCINO device, you can make a rich, creamy froth in just a few seconds. Great coffee for all with De'Longhi!

MAKING COFFEE

ENSURE THAT THE APPLIANCE IS NOT PLUGGED IN AND PLACE IT ON A FLAT, LEVEL SURFACE.

Using for the first time

- Open the lid (16) and unscrew the boiler tank safety cap (15) anti-clockwise.
- Fill the boiler tank completely with water, using the relevant measure (14). The hole near the safety cap (Fig. 2) allows any excess water poured in with the measure to fall into the drip tray (5).
- Tighten the boiler tank cap securely, turning it clockwise.
- Dose the ground coffee in the Thermocream® filter (12) using the relevant measure (9): one dose for one cup of coffee, two doses for two cups.

The Thermocream® filter (12) has a single hole in its lower part to guarantee that coffee is dispensed at high pressure (Fig. 3) which means that the result is a rich, thick cream.

- Add the coffee evenly **without pressing it**.
- Insert the filter holder into the proper seating, turning it 40-45° clockwise until it clicks into place (Fig. 4).

WARNING: If you put too much ground coffee in the filter, it may become difficult to turn the filter holder inside its seat and/or the filter holder may leak when dispensing coffee.

- Plug the power cord into a mains socket.
- Push the power lever (7) back to the pre-heat position (Fig. 5). The pre-heat indicator light (8) will switch on.
- While the coffee maker is heating up it is normal for small amounts of steam to be form around the boiler cap.
- After around 3 minutes, once the temperature has been reached, the pre-heat indicator light (8) will switch off and the appliance will emit a sound signal. At this point, the appliance is ready to dispense coffee.
- Place one or two small cups (according to the amount of coffee used in the filter) below the filter holder.
- Pull the power lever (7) all the way forwards to begin dispensing the coffee (Fig. 6).

The sound signal may continue even during coffee dispensing.

If coffee dispensing is not begun immediately, **the appliance will continue to emit its sound signal for the entire time that the water in the boiler tank is at the correct temperature.**

In any case, we recommend that you do not wait too long before dispensing coffee because this could alter the taste, leading to coffee with a burnt flavour.

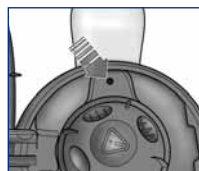

Fig. 2

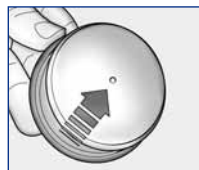

Fig. 3

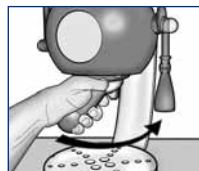

Fig. 4

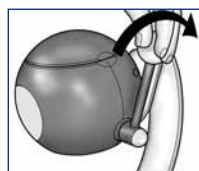

Fig. 5

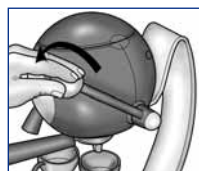

Fig. 6



Fig. 7

- Once the coffee has reached the required level in the cup, stop dispensing by moving the lever (7) back to the upright standby position (Fig. 7).

If the lever (7) is not moved back to the upright position after use, small amounts of water and steam may leak out from the coffee dispensing nozzles for as long as there is water in the boiler tank. This does not mean that the appliance is malfunctioning. To resolve this problem, it is sufficient to move the lever (7) to the upright standby position.

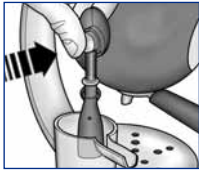

Fig. 8

Successive use

- To dispense more coffee immediately after, proceed as follows:
- Unhook the filter holder from the body of the machine and clean out the coffee grounds from previous dispensing.
- Place the empty water measure under the MAXI CAPPUCCINO device (3) and release all residual steam inside the boiler by holding down the steam dispenser button (4) (Fig. 8). With the button pushed, it is possible to bring the measure forward into its fixed position, allowing you to take your finger off the steam dispenser button and simply wait for the remaining residual steam to discharge.
- When the steam is all out, move the device (3) back to its initial position, pushing it back with the measure (Fig. 10).
- Unscrew the safety cap to refill the boiler tank and then follow the steps described here above.



Fig. 9

WARNING: The boiler tank cap is fitted with a safety valve which allows it to be unscrewed only if all residual steam has been completely released.

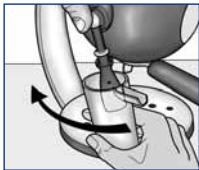

Fig. 10

MAKING CAPPUCCINO

To make a cappuccino or hot chocolate, or to heat any other beverage, proceed as follows:

If the coffee has already been prepared:

- Move the power lever (7) to the pre-heat position (Fig. 5). In this position, the boiler tank remains pressurised without dispensing any liquid from the nozzles on the filter holder.
- Place the container of milk to be foamed (or liquid to be heated) under the MAXI CAPPUCCINO device (3) and press the steam button (4) to start the jet of steam (Fig. 11). While holding down the button, you can move the MAXI CAPPUCCINO device (3) forwards using the milk container until it is in the fixed position, allowing you to remove your finger from the steam button and to wait until the



Fig. 11

milk is ready following the direction of rotation of the device (3) as shown in (Fig. 9). During steam dispensing the sound signal may go on and off, indicating that the boiler is maintaining its temperature. The steam jet shuts off automatically as the MAXI CAPPUCCINO device is brought back into its original position by pushing it back using the milk container (Fig.10).

- Once steam dispensing has finished, move the power lever (7) back to the upright position (Fig. 7) and, using a sponge, clean all residues of the liquid heated from the MAXI CAPPUCCINO device.
- If the steam pressure should be insufficient for frothing the milk, fill the boiler again following the procedures described in the paragraph "Successive use".

For the best results, we recommend that you prepare the coffee before frothing the milk.

If the coffee has not already been prepared:

- Fill the boiler tank (as explained in the section entitled "Making coffee") and move the power lever (7) to the pre-heat position (Fig. 5). The indicator light (8) will switch on.
- When the front indicator light switches off, indicating that that temperature inside the boiler tank has reached the optimum level, the appliance will emit a sound signal. Then place the container of milk to be foamed (or liquid to be heated) under the MAXI CAPPUCCINO device (3) and press the steam button (4) until the liquid is heated or foamed as required (Fig. 11). To make this operation easier, position the device in the fixed position with the help of the container itself, rotating the device (3) forward as shown in Fig. 9. **During steam dispensing the sound signal may go on and off indicating that the boiler is maintaining its temperature.**
- To stop the jet of steam, release the button (4) or bring the MAXI CAPPUCCINO device back to its original position by rotating it back as shown in Fig. 10.
- Return the lever to its upright position (Fig. 7), and using a sponge, clean all residues of the heated liquid from the MAXI CAPPUCCINO device.

WARNING: While dispensing steam, always take care never to place your hands beneath the MAXI CAPPUCCINO device, which issues a hot jet of steam. **Risk of scalding.**

- After dispensing steam, water residues may continue to come out from the MAXI CAPPUCCINO device (3). To avoid wetting the surface on which the appliance stands, open the drip tray (5), by pressing your finger on its right-hand side (Fig. 12).



Fig. 12

REGULAR CLEANING

WARNING: All cleaning operations described here must only be performed when the appliance is unplugged from the mains power.

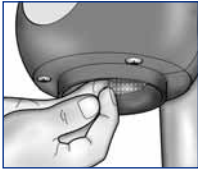

Fig. 13

Cleaning the Thermocream® coffee filter (12)

Make sure that both the internal holes and the single coffee dispenser hole are not clogged, if necessary, clean them with a small brush.

Cleaning the Thermocream® plate (13)

Remove the disc from the filter holder and rinse it under running water.

Cleaning the filter holder hook seat

With use, the filter holder hook seat may become soiled with coffee grounds that can be cleaned off with a sponge (Fig. 13).

Cleaning the MAXI CAPPUCCINO device (3)

WARNING: To prevent the risk of scalding, only clean the MAXI CAPPUCCINO device (3) once it is cool.

Unscrew the device from its support pipe (Fig. 14), and wash it in warm soapy water, rinse and dry thoroughly. Make sure that the two seals are in good conditions and in the correct place. The pipe can be cleaned with a non-abrasive cloth. Screw the MAXI CAPPUCCINO (3) device back until it clicks into place, but make sure not to tighten it excessively. If necessary, use a pin to clean the steam dispensing hole.

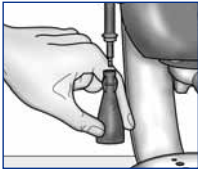

Fig. 14



Fig. 15

Cleaning the removable cup grille (6) and drip tray (5)

- Remove the cup grille (6) and drip tray (5) (Fig. 15).
- Wash in warm soapy water, rinse and dry thoroughly.
- Refit the drip tray (5) slotting the four bottom holes onto the four pegs in the base (Fig. 16).
- Refit the grille (6) by placing one of the alignment holes level with the tab on the drip tray (Fig. 17).

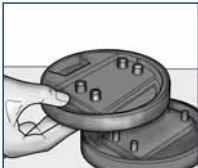

Fig. 16

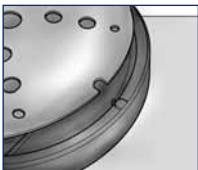

Fig. 17

DECALCIFICATION OF THE COFFEE MAKER

The coffee maker requires regular decalcification. The frequency depends on the quality of the water used and the amount the maker is used.

In any case, it is strongly advised that you decalcify the coffee maker every 800 uses, (or about every 6 months). Use DURGOL, available at De'Longhi Authorised Assistance Centres (see also website www.dur-golswissespresso.com).

Proceed as follows:

- Remove the filter holder from its hook.
- Dissolve one full tea-spoon of decalcifying product (about 8 g.) in 1 measure (14) of warm water (about 220 ml), pour the solution into the boiler and close the boiler cap.
- Place a container under the coffee dispenser lip (with the filter holder removed), and another container under the steam arm.
- Bring the lever (7) to the pre-heat position (Fig. 5).
- Once the sound signal comes on, wait 2 minutes, then dispense one cup of water bringing the lever completely forward (Fig. 6).
- Push the lever back to the pre-heat position, and immediately dispense the steam from the MAXI CAPPUCCINO device (3).
- Repeat the entire procedure once more, ALWAYS following the steps described in the paragraph "Successive use".

The decalcifying product remaining in the packet can be stored in a dry place for the next time you decalcify the coffee maker.

Once finished decalcifying the coffee maker, rinse the boiler well with fresh water, then run the machine twice successively with only water so as to remove any trace of acid in the system.

TROUBLESHOOTING

The appliance does not dispense any steam:

- The MAXI CAPPUCCINO device needs cleaning: use a pin to remove any scale build up inside the hole on the MAXI CAPPUCCINO (3).
- The water level in the boiler tank is insufficient: refill the boiler tank, taking the necessary precautions as described in the paragraph "Successive use" and repeat the steps for dispensing steam.

Coffee leaks out from the sides of the filter holder:

- Probably, too much ground coffee has been placed in the filter, preventing the filter holder from being correctly tightened in its seat: repeat the operation, this time using the correct amount of coffee.
- There are residues of ground coffee on the seal of the filter holder seat: clean the seal of the perforated disc with a damp sponge (Fig. 12)
- If the problem persists after you have followed these procedures, contact an Authorised Assistance Centre.

Coffee is not dispensed, is dispensed too slowly, or is dispensed unevenly from the dispenser holes:

- It is possible that slow coffee dispensing depends on a lack of water coming from the perforated disc in the filter holder seat. In fact, it is

possible that after a few months of use, coffee residues or scale can clog the holes in the disc: clean it with a damp sponge (Fig. 13).

- There is no water in the boiler tank: fill the tank completely using the relevant measure, as explained in the paragraph "Successive use".
- Uneven dispensing from the two dispenser holes could be caused by overfilling of the coffee filter, or by coffee that is too finely ground or pressed.

The indicator light does not switch on:

- The power cord is not connected to the power mains. Make sure that the appliance is plugged in correctly.
- It is possible that the boiler tank is not functioning correctly: if the problem persists after you have followed the above procedure, contact an Authorised Assistance Centre.

Coffee is too watery and cold:

- The coffee blend has been ground too coarsely: for a more concentrated, hotter coffee, it is best to use a more finely ground blend. We also recommend pre-heating the coffee cups by rinsing them in hot water.

The materials and the objects destined for contact with food products are in compliance with the regulations of the EEC directive 2004/1985.

IMPORTANT INFORMATION FOR CORRECT DISPOSAL OF THE PRODUCT IN ACCORDANCE WITH EC DIRECTIVE 2002/96/EC.



At the end of its working life, the product must not be disposed of as urban waste.

It must be taken to a special local authority differentiated waste collection centre or to a dealer providing this service. Disposing of a household appliance separately avoids possible negative consequences for the environment and health deriving from inappropriate disposal and enables the constituent materials to be recovered to obtain significant savings in energy and resources. As a reminder of the need to dispose of household appliances separately, the product is marked with a crossed-out wheeled dustbin.

Electrical Requirements

Before using this appliance ensure that the voltage indicated on the product corresponds with the mains voltage in your home, if you are in any doubt about your supply contact your local electricity company.

The flexible mains lead is supplied connected to a B.S. 1363 fused plug having a fuse of 13 amp capacity. Should this plug become damaged it should be cut off and replaced with a suitable plug, following the procedure outlined below.

Note: Such a plug cannot be used for any other appliance and should therefore be properly disposed of, (having removed the fuse) and not left where children might find it and plug it into a supply socket - with the obvious consequent danger.

N.B. We recommend the use of good quality plugs and wall sockets that can be switched off when the machine is not in use.

Important: the wires in the mains lead fitted to this appliance are coloured in accordance with the following code:

GREEN AND YELLOW
BLUE
BROWN

EARTH
NEUTRAL
LIVE

As the colours of the wires in the mains lead of this appliance may not correspond with the coloured markings identifying the terminals in your plug, proceed as follows:

The wire which is coloured green and yellow must be connected to

Warning
this appliance must be earthed

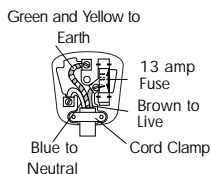

the terminal in the plug which is marked with the letter **E** or by the earth symbol  or coloured green or green and yellow. The wire which is coloured blue must be connected to the terminal which is marked with the letter **N** or coloured black. The wire which is coloured brown must be connected to the terminal which is marked with the letter **L** or coloured red. When wiring the plug, ensure that all strands of wire are securely retained in each terminal. Do not forget to tighten the mains lead clamp on the plug. If your electricity supply point has only two pin socket outlets, or if you are in doubt, consult a qualified electrician. Should the mains lead ever require replacement, it is essential that this operation be carried out by a qualified electrician and should only be replaced with a flexible cord of the same size. If the plug is a moulded-on type the fuse cover must be refitted. If the fuse cover is lost, the plug must not be used until a replacement cover is obtained. The colour of the correct replacement fuse cover is that of the coloured insert in the base of the fuse recess or elsewhere on the plug. Always state this colour when ordering a replacement fuse cover. Only 13amp replacement fuses which are asta approved to B.S. 1362 should be fitted.

Service and Customer Care

- If the cord is damaged it must, for safety reasons, be replaced by DE'LONGHI or an authorised DE'LONGHI repairer.
UK

If you need help with:

- using your kettle
- servicing or repairs (in or out of guarantee)
- ☎ call De'Longhi Customer Care on 023 9239 2333. Have your model number ready - it is located on the underside of your kettle.
- spares and attachments
- ☎ call 0870 4296438.

COD. 4065100700

De'Longhi, New Lane, Havant, Hampshire PO9 2NH, UK
www.delonghi.com



Cappuccino and
Espresso Coffee Maker
EC11