



# USE AND MAINTENANCE MANUAL

## HERBICIDE SPRAYERS

### TRACTOR-MOUNTED SPRAYERS

**CAMPO 11 - 16 - 22 - 32**

**DSP 11 - 16 - 22 - 32**

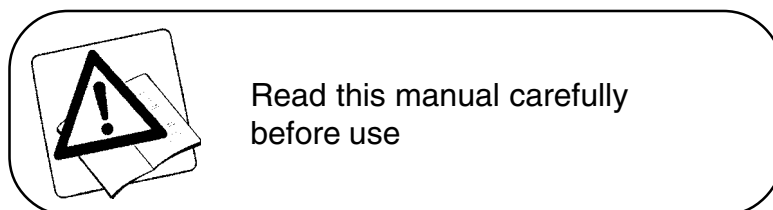

Read this manual carefully  
before use

# Summary

<b>1</b>	<b>USING AND KEEPING THE USE AND MAINTENANCE MANUAL .....</b>	<b>4</b>
1.1	COMPOSITION OF THE MANUAL .....	4
1.2	GUARANTEE .....	4
1.3	PRODUCT RESPONSIBILITY .....	4
1.4	WARNING SIGNS IN THE MANUAL AND ON THE MACHINE .....	4
<b>2</b>	<b>SAFETY REGULATIONS AND RESIDUAL RISKS .....</b>	<b>5</b>
2.1	INTENDED USE .....	6
2.2	PROHIBITED USE .....	6
2.3	USING CHEMICAL PRODUCTS .....	6
2.3.1	REGULATIONS FOR THE USE OF CHEMICAL PRODUCTS .....	6
2.4	RECOMMENDATIONS .....	6
2.4.1	TAKING PRECAUTIONS AGAINST FIRE HAZARDS .....	7
2.5	WEATHER CONDITIONS .....	7
2.6	MACHINES DESIGNED TO BE USED ONLY WITH CLEAN WATER .....	7
2.7	DRIVING ON THE ROAD .....	7
<b>3</b>	<b>CHARACTERISTICS AND SPECIFICATIONS .....</b>	<b>7</b>
3.1	TABLES OF FITTINGS ALLOWED .....	7
3.2	NOISE LEVEL OF THE MACHINE .....	8
3.3	STANDARDS OF REFERENCE: .....	8
<b>4</b>	<b>USER'S INSTRUCTIONS .....</b>	<b>8</b>
4.1	DESCRIPTION OF THE MACHINE .....	8
4.1.1	WORK STATIONS .....	9
4.1.2	HAND WASHING TANKS .....	9
4.2	PRELIMINARY CHECKS .....	9
4.3	TRANSPORTING AND MOVING THE MACHINE .....	9
4.3.1	TOWED SPRAYERS .....	10
4.4	TRACTOR COUPLING .....	10
4.4.1	STANDARD VERSION (ELEVATOR COUPLING) .....	10
4.4.2	HOOK VERSION (HOMOLOGATED) .....	11
4.4.3	PARKING FOOT .....	11
4.4.4	WHEEL SPACING ADJUSTMENT .....	11
4.4.5	HYDRAULIC CONNECTION TO THE DISTRIBUTORS .....	12
4.5	CARDAN SHAFT .....	12
4.6	PUMP .....	13
4.7	SUCTION FILTER .....	13
4.8	PRESSURE REGULATOR .....	14
4.8.1	COMPONENTS OF THE PRESSURE REGULATOR .....	14
4.8.2	GENERAL INSTRUCTIONS .....	14
4.9	DELIVERY FILTERS (ONLY EQUIPPED MODELS) .....	15
4.10	SPRAYING COMPUTER (OPTIONAL) .....	15
4.11	FILLING THE TANK .....	16
4.12	MIXING .....	16
4.12.1	MANUAL PREMIXING .....	16
4.12.2	PREMIXER ON COVER (OPTIONAL): .....	16
<b>4.12.3</b>	<b>PREMIXER ON HOPPER WITH TIN WASHER (OPTIONAL) .....</b>	<b>17</b>
4.12.4	TOP-MIX PREMIXER FOR CAMPO 11-16-22E (OPTIONAL) .....	18
4.12.5	TOP-MIX CALIBRATED NOZZLE FOR CAMPO 11-16-22E .....	18
4.12.6	HOW TO USE THE LP83 INCORPORATOR .....	18
4.13	WASHING THE SPRAYER .....	19
4.13.1	CIRCUIT WASHER AND TANK WASHER .....	19
4.13.2	WASHING WITH FULL TANK (OPTIONAL) .....	19
<b>5</b>	<b>HORIZONTAL BOOMS FOR HERBACIOUS CULTIVATIONS .....</b>	<b>20</b>
5.1	HYDRAULIC HERBICIDE BOOMS .....	20
5.1.1	INDIPENDENT HYDRAULIC PLANT .....	20
5.1.2	OIL FEED FROM TRACTOR .....	20
5.2	AIR-ASSISTED BOOMS .....	21
5.3	SELF-LEVELING DEVICES .....	21
5.3.1	VARIABLE GEOMETRY .....	21

5.4	LIFTING .....	22
5.5	DISTRUBUTION WITH HERBICIDE BOOM .....	22
5.5.1	DESCRIPTION OF TYPE OF JETS .....	22
5.5.2	DESCRIPTION OF TYPE OF NOZZLES .....	22
5.5.3	DISTRUBUTION .....	22
5.6	MARKER .....	24
<b>6</b>	<b>HAND LANCES .....</b>	<b>24</b>
<b>7</b>	<b>HOSE REEL .....</b>	<b>24</b>
<b>8</b>	<b>MAINTENANCE .....</b>	<b>25</b>
8.1	PROGRAMMED MAINTENANCE .....	25
8.2	ROUTINE MAINTENANCE .....	25
8.3	EXTRAORDINARY MAINTENANCE .....	25
8.4	MAINTENANCE OF THE HERBICIDE BOOM - SELF-LEVELLING DEVICE - LIFTING SYSTEM .....	25
8.5	REPAIRS .....	25
8.6	STORAGE IN A WAREHOUSE AND TRANSPORTATION .....	25
8.7	PUTTING BACK INTO SERVICE AFTER WINTER LAYUP .....	26
8.8	DEMOLITION AND DISPOSAL .....	26
8.8.1	MATERIALS FOR DEMOLITION .....	26
8.8.2	INDICATIONS FOR A SUITABLE TREATMENT OF WASTE .....	26
8.8.3	ELECTRICAL AND ELECTRONIC APPARATUS WASTE (EEAW) .....	26
<b>TAB.1</b>	<b>CHARACTERISTICS NOZZLES ISO .....</b>	<b>28</b>
<b>TAB.2</b>	<b>CHARACTERISTICS NOZZLES CONICAL ISO .....</b>	<b>29</b>
<b>TAB.3-4</b>	<b>CAPACITY HAND LANCES .....</b>	<b>30</b>
<b>TAB.5-6</b>	<b>SPRAYING TABLES .....</b>	<b>31</b>
<b>TABLE 8</b>	<b>PROBLEMS, CAUSES AND SOLUTIONS.....</b>	<b>32</b>
<b>TABLE 7</b>	<b>TABLE OF PROGRAMMED MAINTENANCE .....</b>	<b>32</b>
<b>TAB.12A</b>	<b>ALLOWED FITTINGS.....</b>	<b>33</b>
<b>TAB.12B</b>	<b>ALLOWED FITTINGS.....</b>	<b>34</b>

Thank you for having chosen UNIGREEN.

The product you purchased has been designed and built with the greatest attention to the safety of the operator and the environment, nevertheless there are still some residual risks due to the nature of the product used.

For this reason we recommend reading all of this manual to avoid making mistakes in the first period of use and to get the most out of the working life of the sprayer in time, doing the programmed maintenance at regular intervals.



## 1 USING AND KEEPING THE USE AND MAINTENANCE MANUAL

The manual is an integral part of the machine and should be kept in a safe place where it can be reached easily for consultation.

### 1.1 COMPOSITION OF THE MANUAL

This manual consists of various parts to make it easier to consult by subject and to avoid repetitions; the following are part of the manual:

- a) pump handbook
- b) pressure regulator handbook (manual or electric)
- c) spraying computer handbook (if fitted)
- d) optional accessories handbooks (marker, premix, cardan shaft, etc.)

UNIGREEN reserves the right to make changes to the manual without prior warning and the normal printing cycles may vary slightly.

### 1.2 GUARANTEE

The enclosed card indicates the conditions of the UNIGREEN guarantee. The UNIGREEN guarantee covers the repair or replacement of parts considered manufacturing flaws, according to the unquestionable judgement of UNIGREEN, only after the authorised agent for that zone has verified the fault. Ambit of the guarantee

The guarantee doesn't cover cases of normal wear, negligent use, poor maintenance and/or improper use.

**The following materials subject to normal wear are not covered by the guarantee:** gaskets and seals, diaphragms, seal rings, tubes and pipes, nozzles, pressure gauges, oil, tyres, friction material of the clutches.

**Evident cases of negligence include:** work speed over that indicated in the spraying tables in the handbook (or too high for the conditions of the terrain), use of herbicide booms without an auto-levelling system or with the auto-levelling system blocked, power-takeoff speed over 540 rpm.

Mounted sprayers: activation of the three-point elevator with cardan shaft engaged and power-takeoff operational.

And anything else indicated in the present Use and Maintenance Manual.

#### **Maintenance:**

The guarantee is void if the maintenance indicated in the tables in this manual isn't respected, regarding the period and deadline of the interventions, washing the machine and the circuit at the end of the treatment.

#### **Improper use:**

The use the UNIGREEN machines are designed for is indicated in this manual, any other use is forbidden and makes the guarantee void.

### 1.3 PRODUCT RESPONSIBILITY

UNIGREEN spa is not responsible if:

- a) During the working life of the machine the normal maintenance operations aren't performed and documented as indicated in this handbook, in the enclosed handbooks of the pumps-motors-regulators-etc. and in any case as is customary for the normal maintenance of mechanical machinery.
- b) The machine is equipped with non original accessories or components or parts that aren't acknowledged by UNIGREEN as their own.
- c) The machine is equipped with original accessories or components that are unsuitable in the measurements, weight or version for the same. Please consult the page of available and recommended fittings.
- d) Not following the instructions in the manual whether totally or partially.
- e) Modifications made to the machine that haven't been authorised by UNIGREEN.

### 1.4 WARNING SIGNS IN THE MANUAL AND ON THE MACHINE

Below you will find all of the pictograms on the machine, in order to illustrate the warnings, the prohibitions and the correct method of use.

The operations that require particular attention are shown in the images beside the text.

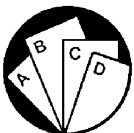

Composite handbook, consult the specific files on the various components



### Key to the symbols

- 1- Read the Use and Maintenance manual
- 2- Stop the machine and read the manual before every intervention
- 3- Don't lubricate while running
- 4- Don't drink
- 5- Don't dispose of residue liquids in the environment
- 6- No smoking
- 7- Danger, risk or injury, don't get near the machine until the moving machine members have stopped
- 8- Danger of crushing, don't get your hands near the moving mechanical machine members
- 9- Danger, risk or injury caused by fluids under pressure
- 10- Don't climb on the machine during work or transfers
- 11- Don't climb on the tank
- 12- Don't enter in the tank
- 13- Wearing earmuffs is obligatory
- 14- Wearing a face mask is obligatory
- 15- Wearing safety footwear is obligatory
- 16- Wearing protective gloves is obligatory
- 17- Wearing protective overalls is obligatory
- 18- Use a working pressure under that indicated in red on the manometer.
- 19- Don't get your hands near the moving cardan shaft
- 20- Make sure power-takeoff of the tractor turns in the right direction and runs at the right speed.
- 21- Beware of the possibility of the raised boom falling
- 22- Danger of contact with the electric power lines
- 23- Don't stand between the machine and the tractor
- 24- Danger of lateral skidding

## 2 SAFETY REGULATIONS AND RESIDUAL RISKS

In relation to safety, the following terms will be used:

**Dangerous zones:** any zone inside and/or near the machine where the presence of a person exposed constitutes a risk for the safety and health of the same person.

**Person exposed:** any person who has their body or any part of their body in a dangerous zone.

Before starting the machine, the operator must check for any visible faults in the safety devices and the machine itself.

Never start the machine until you have told anyone in the range of action of the machine to move away and they have done so.

The protective devices must not be removed or disabled when the machine is running.

It is obligatory to keep all the plates with danger and safety signs in perfect conditions. If they get damaged or deteriorate, replace them in good time.

Replace parts believed to be faulty with others indicated by UNIGREEN.

NEVER try makeshift or hazardous solutions.

Don't wear clothes, jewellery, accessories, or anything else that can get caught in the moving machine members.

Pay the greatest attention to all the warning and danger signs on the machine.

Don't use the machine for any other purpose other than that indicated in the manual.

The machine has been designed and built with the appropriate devices to guarantee the safety of the user.

In any case there are some residual risks associated with the improper use of the machine by the operator; for this purpose danger signs and symbols and prohibitions are applied near some parts of the machine (see previous pictograms).

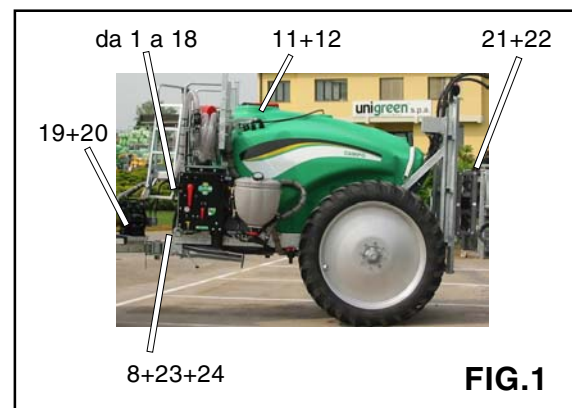

**FIG.1**  
INDICATIVE POSITION  
OF THE WARNING SIGNS ON THE SPRAYER  
NB: the position may vary on the basis of the characteristics of the model.





## 2.1 INTENDED USE

The sprayer in this series is built for agricultural use. The materials used are resistant to normal chemical products used in agricultural spraying (or herbicides) at the time of construction.

Any other use is not allowed and the manufacturer is not responsible for any damage caused by aggressive, dense or sticky chemicals.

**THE USE OF THE MACHINE BY PERSONS UNDER 18 YEARS OF AGE IS STRICTLY FORBIDDEN**

The use of liquid fertilizers in suspension is not allowed, while the use of the same in a solution is possible if requested when the machine is ordered from Unigreen and in any case changing some of the parts described in the handbooks of the regulator, such as the manometer (stainless steel), the nozzles (large diameter ceramic) and eliminating the fine mesh filters to prevent blockages.

## 2.2 PROHIBITED USE

Using the machine with the following products is strictly forbidden:

- = Paints of any kind and type
- = Solvents or thinners for paints of any kind and type
- = Combustibles or lubricants of any kind and type
- = LPG or gas of any kind and type
- = Flammable liquids of any kind and type
- = Liquid foodstuffs, whether for animals or humans
- = Liquids containing granules or consistent solids
- = Mixtures of various incompatible chemical products
- = Liquid fertilizer or manure in suspension with lumps and/or that is particularly dense
- = Liquids with a temperature of over 40°C
- = Any products that aren't suitable for the specific use of the machine.

## 2.3 USING CHEMICAL PRODUCTS

All pesticides or herbicides can be dangerous to humans and the environment if used erroneously or inadvertently.

Therefore we recommend that only suitably trained persons should use these products (license) and in any case only after having carefully read the instructions on the container.



### 2.3.1 REGULATIONS FOR THE USE OF CHEMICAL PRODUCTS

Some recommendations for avoiding damage and accidents:

- = Keep the machine in a suitable, protected place with no access for children or strangers
- = Handle the products with care, wearing rubber acid-proof gloves, goggles- face masks or filtering helmets, overalls made of water-repellent fabrics or TIVEK and boots made of rubber or similar materials.
- = If chemical products or mixtures of product come into contact with the eyes or are swallowed consult a doctor immediately, taking the label of the product with you.
- = Wash all clothes that come into contact with the chemical, whether diluted or undiluted, thoroughly before using them again.
- = Don't smoke, drink or eat when preparing or spraying the mix or near or in the fields treated.
- = **DON'T ENTER THE TANK:** the residues of a chemical product can cause poisoning and suffocation.
- = When spraying, respect safe distances from residential areas, water courses, roads, sports centres and public parks or paths.
- = Thoroughly wash the containers of plant protection products using the relevant accessories, rinsing several times with clean water. The liquids used for washing can be used for treatment.
- = Collect the washed containers and send them to the relevant collection centres. Never dispose of them in the environment and don't use them again for any other purpose. It is good practice to knock a hole in the bottom of the tins so they can't be used again.
- = When you have finished spraying, wash the sprayer thoroughly, diluting the residues with a quantity of water at least 10 times that of the residues, spraying the resulting mix over the treated field.



NON SCARICARE I  
RIFIUTI NELL'AMBIENTE  
DO NOT POLLUTE THE  
ENVIRONMENT/DOSE OF PROPERLY

## 2.4 RECOMMENDATIONS

a) Refer to the present handbook for the use and maintenance of the frame, tank, auto-levelling systems, elevators, mechanical and hydraulic herbicide booms, spray booms and hose reels.

Refer to the enclosed handbooks for the use and maintenance of the pump and pressure regulator and any accessories or motors.

**b)** Please contact the agent in your zone, the nearest authorised workshop or UNIGREEN S.p.A. directly for any repairs the user feels they aren't capable of performing alone. (see point 8.5)

**c)** Due to the complexity of the equipment and the variety of technologies used (mechanical, hydraulic, oil-pressure and electrotechnical) operators must not dismantle or modify the equipment. All of the relevant operations must be performed by specialised personnel, authorised by UNIGREEN S.p.A.

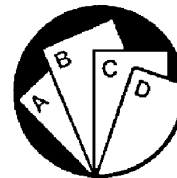

### 2.4.1 TAKING PRECAUTIONS AGAINST FIRE HAZARDS

Don't use naked flames or heat sources near the machines.

The sprayers are made with many materials that derive from petroleum: tanks, tubes, pipes and hoses, wheels and plastic parts; furthermore the presence of oils of various nature and residues of chemical products make them potentially flammable.

### 2.5 WEATHER CONDITIONS

We recommend spraying in the early hours of the morning or late in the afternoon, avoiding the hottest time of day.

Never do any spraying if it's raining or rain is forecast.

Don't spray in strong wind or in any case, in winds above 3/5 m/second.

If you have to spray in windy conditions, use relatively low pressures to obtain quite large drops that are less sensitive to drifting (being heavier the wind has less effect). There are also special anti-drift nozzles available from UNIGREEN S.p.A.; for information, please contact our offices.

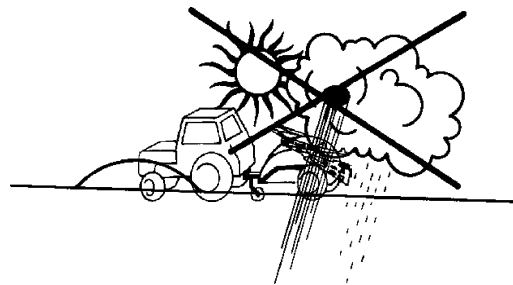

### 2.6 MACHINES DESIGNED TO BE USED ONLY WITH CLEAN WATER

There are versions of the machines designed only to be used with a hose reel for washing with cold clean water.

These machines cannot be used with chemical products as they don't have some of the devices or accessories that are needed to use these products safely.

These machines are identified by the word "washing" on the CE plate.

### 2.7 DRIVING ON THE ROAD

The CAMPO series atomisers are not specifically designed for road use.

Nevertheless, many models are also available in the version homologated for road traffic with the tank empty.

You should check with your local reseller on the correct couplings to use and use tractors that meet the regulations in force.

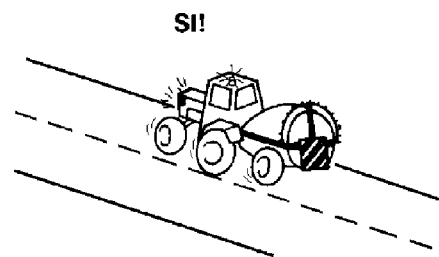

## 3 CHARACTERISTICS AND SPECIFICATIONS

This handbook is valid for tractor-mounted sprayers to be used with:

**a)** horizontal booms per herbaceous cultivations (herbicides, insecticides, fungicides, foliage nutrient, etc.)

**d)** treatments with hand lances with or without a hose reel

**e)** hand lances for washing with or without a hose reel

The UNIGREEN S.p.A. sprayers are identified by the CE plate (FIG. 2) bearing one of the marks indicated in the tables of the allowed fittings (TABLE N° 12 pag. 33-34). The tables above contain a summary of the indications envisaged for the markings.

### 3.1 TABLES OF FITTINGS ALLOWED

Table N° 12 let you identify the version of your machine indicating the basic equipment and all the possible fittings available (optional).

You can also find the other fittings allowed or other versions to meet your requirements in the future.

THE FITTING DEFINED IN TABLES N° 12 (pages 33-34) SHOULD BE CONSIDERED BINDING FOR THE VALIDITY OF THE DECLARATION OF CONFORMITY.

Other fittings or setups of basic components and optionals should be considered unsafe and therefore are not covered by the guarantee and aren't UNIGREEN's responsibility.

The same goes for fittings realised with components or accessories that aren't original UNIGREEN parts.

UNIGREEN accessories can easily be identified by the label with the yellow background "ORIGINAL UNIGREEN ACCESSORY"

●	TYPE : .....	●
code: .....	N° .....	
massa a vuoto: .....	Kg. max press. : .....	bar
	net mass	
●	massa totale ammessa: .....	Kg.
	total mass	
	<b>unigreen</b> S.p.A.	<b>CE</b>
	SPRAYING EQUIPMENT	ANNO YEAR
	via Rinaldi, 105 - Reggio Emilia ITALIA	20 .....
●		made in Italy

FIG. 2



### 3.2 NOISE LEVEL OF THE MACHINE

Use earmuffs to protect your ears when using the machine,

Sprayers that are equipped with just a pump and hydraulic plant

**ACOUSTIC POWER LEVEL** emitted by the machine: **106,0 dBA**

**ACOUSTIC PRESSURE LEVEL AT THE OPERATOR'S POSITION** emitted by the machine: **91,4 dBA**

Sprayers that are equipped of air sleeve (VENTO)

**ACOUSTIC POWER LEVEL** emitted by the machine with impeller Vento: **114,8 dBA**

**ACOUSTIC PRESSURE LEVEL AT THE OPERATOR'S POSITION** emitted by the machine with impeller Vento: **97,6 dBA**

Readings taken in accordance with the following standards:

Machines Directive 98/37/CE (89/392 CE Dir. re-codified).

Legislative Decree D.Lgs. n°292 of the 4th of September 2002 concerning the environmental acoustic emission of machines and equipment for use outdoors.

Italian Legs. Decree no. 195 of 10/4/2006 on the subject of the protection of workers against the risks deriving from exposure to chemical, physical and biological agents. UNI EN 1553:2001 appendix D

### 3.3 STANDARDS OF REFERENCE:

- MACHINES DIRECTIVE 98/37/CEE (89/392 CE Dir. re-codified).

- Directive 86/188/CEE: risks deriving from exposure to noise (implemented in Italy by Legislative Decree D.L. 277/1991)

- DPR 547/1955: Regulations for the prevention of accidents and hygiene at work.

- Legislative Decree D.Lgs. n°292 of the 4th of September 2002 concerning the environmental acoustic emission of machines and equipment for use outdoors.

-UNI EN ISO 12100-1/Apr.2005 : Machinery safety - Fundamental concepts, general design principles - Part 1: basic terminology, methodology

-UNI EN ISO 12100-2/Apr.2005 : Machinery safety - Fundamental concepts, general design principles - Part 2: Technical principles

-UNI EN 294/July 1993: Machinery safety, safe distances to avoid reaching hazardous areas with upper limbs.

-UNI EN 349/June 1994: Machinery safety, minimum spaces to prevent crushing of body parts

-UNI EN 907/Nov.1998: Agricultural and forestry machinery - Sprayers and spreaders of liquid fertilizers - Safety.

-UNI EN 954-1/Dec. 1998 : Machinery safety - Fundamental concepts, general design principles

-UNI EN 982/July 1997: Machinery safety. Safety requisites relevant to systems and their components for hydraulic and pneumatic transmissions. Hydraulics.

-UNI EN ISO 4254-1/June 2006: Agricultural machines - Safety - Part 1: General requisites

-ISO 11684/1995: Pictograms - general principles.

## 4 USER'S INSTRUCTIONS

### 4.1 DESCRIPTION OF THE MACHINE

The sprayers are made of a structural steel frame and a polyester tank reinforced with fibreglass or high-density polyethylene.

The frame is painted with special fired epoxy paints or, depending on the versions, hot galvanised. The tank is easy to empty and this makes it possible to use the machine even on hillsides.

The pumps are generally diaphragm pumps but in some cases fitted with pistons.

The accessories that can be used to complete the sprayer include: lifting devices, self-levelling devices, mechanical or hydraulic herbicide booms, jets and nozzles and this makes the UNIGREEN sprayer a highly qualified and efficient piece of equipment.



#### 4.1.1 WORK STATIONS

The use of this machine does not envisage an operator standing constantly near the same, the operator normally sits in the cab of the tractor. During calibration and maintenance operations the operator will be working near the machine at ground level (for all the calibration and maintenance operations refer to the relevant chapters).

In some special models with controls above 1.5 metres there is a platform to make these operations easier.

This platform must only be used with the machine stopped.

NOTE: Put the ladder back into the correct operating position after use, securing it with the hook; make sure not to pinch or crush your hands during these operations.



#### 4.1.2 HAND WASHING TANKS

The sprayers are supplied with an auxiliary hand-washing tank with clean water and a hand tap.

This tank must always be supplied with water and the inside must be clean so you can wash any parts of the body that come into contact with the chemical product used.

Never drink the liquid inside.



This symbol identifies the clean water tank on the machine used to wash your hands

#### 4.2 PRELIMINARY CHECKS

When you receive the machine, check that it is complete and no parts are missing.

If there are any damaged parts, inform your local reseller or UNIGREEN directly in good time.

When the machine is delivered, make sure you ask:

a) that the machine is delivered with all of its parts fitted and that the fitting meets the requisites in table N° 12 pag. 33-34. (This procedure is necessary because for reasons of space during transportation the machine is often delivered partially dismantled).

b) that it is tested in your presence in particular checking:

= that the suction filter and the inside of the tank are clean and free of work residues.

= that the connections are made correctly following the basic layout (FIG. N° 11).

= that the hose clips and all the unions and connections are tightened properly.

= that any herbicide boom is mounted in the centre.

= that all of the protective covers are fitted solidly to the machine, in particular the protective cover of the power-takeoff of the pump.

= Check the proper tyres inflation (pressure are indicated on tyres)



#### 4.3 TRANSPORTING AND MOVING THE MACHINE

Every time you have to lift the machine, before starting the operation, always make sure the lifting gear and the relevant tools and equipment (cables, hooks, etc..) are suitable for lifting the load and check the stability of the same.

**It is forbidden to unhook and move the machine with the tank full.**

The dry weight of the machine at the maximum level of fitting and with all the accessories allowed is stamped on the nameplate (Fig. 2); use slings and lifting gear with a adequate load-bearing capacity.

Don't stand the sprayer on soft ground or steep slopes.

Never lift or move the sprayers by hand if there is liquid in the tank. The machine will weigh more and the movement of the liquid can change the centre of gravity causing uncontrolled movements.

We recommend using slings as shown in the figure, the lifting points to use on the machine are indicated with the relevant symbol.

Don't lift the machine with the forks of a forklift truck because the machine can tip over due to the overhanging weight of the booms.

Don't pass or stand under the machine when it is being lifted.



This symbol identifies the coupling points of the machine

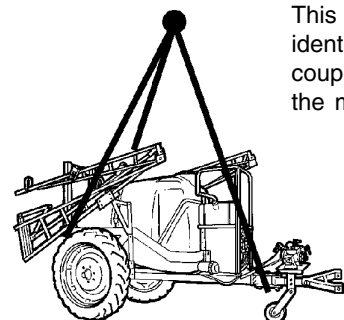
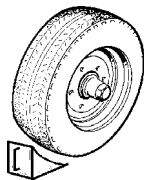

FIG.3



Hinged parking wheel



Hinged parking stand



Tractor coupling for Towed machines: standard version, with elevator coupling.



Tractor coupling for homologated Towed machines in work position (not suitable for road use).

### 4.3.1 TOWED SPRAYERS

#### PARKING

Don't stand the sprayers on unstable ground or steep slopes, the machine is designed to be parked safely on compact ground with a slope of up to 8.5° using the relevant chocks (FIG. 3) in the following way:

- Machine parked with drawbar uphill (max 8.5°), place the chocks behind the wheels.
- Machine parked with drawbar downhill (max 8.5°), place the chocks in front of the wheels.
- Machine parked across the slope (max 8.5°), place one chock in front of the drawbar wheel (in the direction of the slope) and the other in front of the wheel uphill.

#### MOVING THE MACHINE

For lifting, please refer to the general notes above.

CAMPO sprayer models 11 and 16 are fitted with a tilting parking wheel which allows the machine to be pushed over firm, flat ground when the tank is empty. CAMPO sprayer models 22 and 32 are fitted with a tilting parking foot.

To make it easier to move the sprayer when it is not attached to the tractor, the machine and the drawbar are specially equipped for stowing:

- The cardan shaft: swivelling cradle on drawbar.
- The electrical pressure regulator: hoses reel support (the pushbutton panel is normally attached to the tractor or stored in the product basket).

### 4.4 TRACTOR COUPLING

= The tractor must be equipped with a 1 3/8 ASAE DIN 9611/A at 550 rpm power-takeoff capable of supplying the power necessary for operating the machine.

= It must have a towing hitch (towed mistblowers with a towing eye or fork drawbar) and a three-point elevator (for mounted machines and a steering drawbar for towed machines) suitable for safely bearing the weight of the mistblower.

= It must be able to tow the maximum overall mass of the machine. All of the characteristics required are indicated in the fittings tables N° 12 pages 33-34 (the total mass is also indicated on the CE plate on the machine).

**WARNING: make sure there are no persons or things near the mistblower before starting the machine and while you are using it.**

#### 4.4.1 STANDARD VERSION (ELEVATOR COUPLING)

= Check the diameter of the elevator coupling pins. If necessary position the double diameter pins correctly; there are also appropriate adapter bushes available.

= Check that the weight on the hook can be supported by the tractor (the maximum weights on the drawbar are indicated in the fittings tables N° 12 pages 33-34).

= Check that the steering joint is lubricated with grease.

= Keep the towed machine level with the control of the elevator.

= Retract the parking drawbar wheel (or foot) so it doesn't get damaged during work.

B: to perform these operations, check the stability of the machine and observe all the indications relevant to safety in the paragraphs 4.3 TRANSPORTATION AND MAINTENANCE, 8 MAINTENANCE, and 8.5 REPAIRS.

= Position the pressure regulator in a place where it is easy to reach from the driver's seat. Don't carry liquids under pressure inside the cabin; use the relevant electrical or cable controls for these tractors.

= Check that the pipes of the pressure regulator (or the electrical cables on a pushbutton control panel) don't get in the way and are positioned at a safe distance from the cardan shaft and the wheels of the tractor.

#### 4.4.2 HOOK VERSION (HOMOLOGATED)

- = Check that the weight on the hook can be supported by the tractor (the maximum weights on the drawbar are indicated in the fittings tables N° 12 pages 33-34).
- = If the machine is coupled to the tractor by a tow hook, adjust the height of the hook to keep the tank of the sprayer horizontal.
- = When you have connected the drawbar proceed as for the towing steering drawbar.



Tractor coupling for Towed machines:  
homologated version, coupled to tow hook

#### 4.4.3 PARKING FOOT

After attaching the drawbar to the tractor, you must retract the parking foot (or wheel) to prevent damage during operation.

Retract the foot as follows:

- = lift the machine up about 20 cm using the tractor's elevator (if the machine is instead attached to the trailer hook, retract the parking foot by turning the knob)
- = Take out the blocking pin and push the foot up towards the back of the machine.
- = Hold the foot horizontal and put the blocking pin back in, inserting the handle in the slot to keep it from accidentally slipping out.

NOTE: to put the foot back into parking position when you unhook the machine from the tractor after operation, make sure that you follow these instructions:

- = hold up the foot with one hand, while pulling out the blocking pin with the other (guide the foot all the way down with your hand).
- = put the blocking pin back in, adjust the height to keep the tank of the sprayer horizontal.



Estrarre la spina di blocco e ribaltare il piede verso il retro della macchina.



Sostenere il piede orizzontalmente e riposizionare la spina di blocco facendo alloggiare la maniglia nell'apposito incavo per evitare sfilamenti accidentali.

#### 4.4.4 WHEEL SPACING ADJUSTMENT

To adjust the wheel spacing, you must lift up the machine as described in 4.3, or use a jack underneath the machine chassis; if you use a jack, the machine must be hooked up to the tractor so it is properly braked.

The correct position for the jack is shown on the machine in the illustration to the side. Check that the jack is resting steadily on a firm, solid surface.

To adjust the spacing, just loosen the screws holding the axle and pull the hub out to the desired position, then secure it again with the screws.



WARNING: axle track should be adjusted by authorized Unigreen personnel. The length (L) of the axle section inserted in the chassis must never be less than the one indicated in the chart, and the overhang (S) must not be greater; incorrect positioning of the hubs could weaken the axle and cause breakage.

Hub chart (measurements in mm)

series	S (max)	L (min)	T	hub
Campo 11	200	350	550	60x60x550 6c
Campo 16	175	375	550	60x60x550 6c
Campo 16 Riso	200	500	700	70x70x700 8c
Campo 22 C/E	250	450	700	70x70x700 8c
Campo 22 Riso	250	450	700	80x80x700 8c
Campo 22 P	250	450	700	80x80x700 8c
Campo 32 C/P	250	450	700	80x80x700 8c
Campo 22/32 S	300	400	700	100x100x700 8c

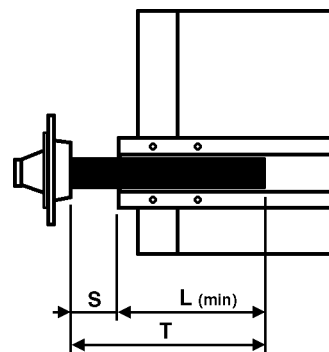





#### 4.4.5 HYDRAULIC CONNECTION TO THE DISTRIBUTORS

The machines that need a hydraulic connection to drive the herbicide booms are equipped with 1/2", "Push-Pull", quick-fit male couplings. You can connect the pipes by simply pushing them in, making sure you:

- proceed only with the engine turned off;
- lower any tools connected to the elevator of the tractor;
- carefully clean the two parts that will be coupled

Warning: the hydraulic cylinders used are the "Double Effect" type. Consult the use and maintenance manual of the tractor.



#### 4.5 CARDAN SHAFT

In some models this is supplied on request.

The cardan shaft must bear the CE mark.

It must always have its own instructions that must be followed scrupulously and it should come with a cover bearing the mark, integrated in every part.

You should have previously checked the length to avoid:

- = if it is too long, DANGEROUS THRUST ON THE PUMP SHAFT
- = if too short, the POSSIBILITY OF DANGEROUS BREAKAGES

THE MINIMUM OVERLAP OF THE TWO TELESCOPIC TUBES MUST NEVER BE LESS THAN 1/3 OF THE LENGTH OF THE TUBES.

The power that can be transmitted by the cardan shaft must be at least equal to that required to run the sprayer. Consider that the power necessary to run a sprayer without the fan is practically the same as that of the pump, the power rating can be found in the pump instructions handbook. Generally 20 bar pumps need 20 hp; 50 bar pumps need 30 hp. These power ratings can be found in tables N° 12 pages 33-34.

FIG. 4

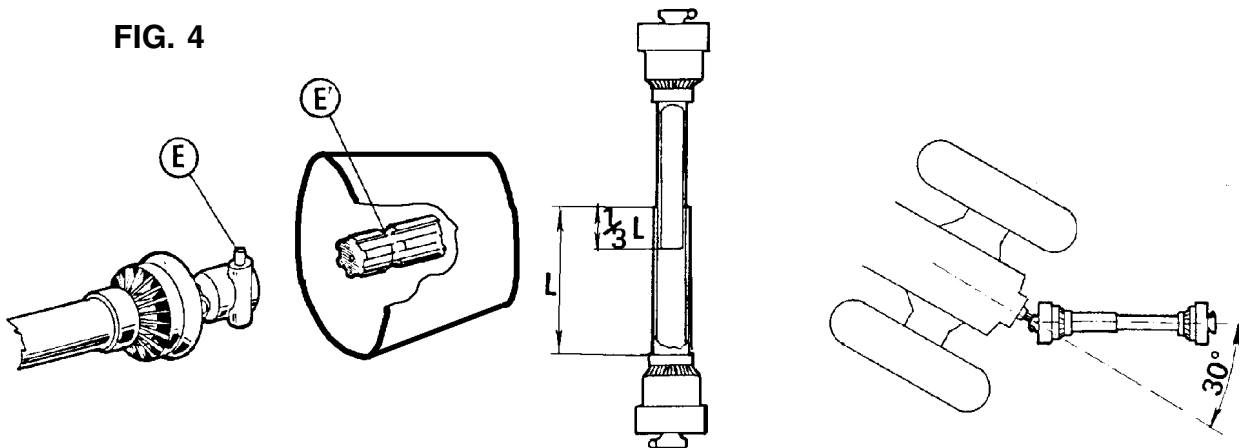

NEVER USE THE CARDAN TRANSMISSION IF THE FOLLOWING PROTECTIVE COVERS ARE MISSING:

- a) TRACTOR POWER-TAKEOFF PROTECTIVE COVER
- b) CARDAN SHAFT PROTECTIVE COVER
- c) FIXED PROTECTIVE COVER ON THE PUMP SHAFT
- d) Hook any safety chains to solid anchor points
- e) Check that the button or ringnut "E" (FIG. 4) is correctly engaged and blocked both on the pump side and on the tractor side.
- f) Don't exceed an inclination of 30°-35° in any direction for any reason
- g) With the machine stopped, periodically grease the spiders and the pipes, keeping the connecting zone particularly clean.
- h) Avoid letting the end of the cardan shaft come into contact with the ground with the machine stopped; use the relevant support on some versions for this, if your machine has no support, hook the external safety chain to a part of the frame of the machine (ex. control unit support).

#### 4.6 PUMP

When using the pump scrupulously observe the instructions in the enclosed handbook supplied by the manufacturer.

The pump can be identified by the ratings plate on the same; the main data on the pressure and delivery are easy to find on this plate.

Normally the pumps mustn't exceed 550 RPM; a higher speed won't improve performance but there is a risk of compromising the life and safety of the pump.

There is a safety valve on the pump, calibrated to prevent overpressure. Don't tamper with this valve for any reason and don't block or obstruct the pipes connected to it in any way.

#### 4.7 SUCTION FILTER

The sprayer is fitted with a suction filter with filter cartridges that have roughly a 50-gauge mesh, which is equivalent to a hole of 0.4 at 0.35 mm.

An efficient filter lets the sprayer work properly.

You should periodically check that the filter cartridge is clean, this check should be done more often if there are impurities in the liquid.

To inspect the filter cartridge wear rubber acid-proof gloves as the liquid in the filter can come into contact with your hands when you open the filter.

Don't perform this operation with the pump running as the depression produced blocks the cover preventing the removal.

Before removing the cover of the filter, make sure that the same is isolated from the tubing by unscrewing the relevant rear valve (FIG. N° 5) or on the 3-way deviator (FIG. N° 11 - pos A).

After washing the cartridge, reassemble the cover making sure you connect the same to the circuit again, using the valves described above in the opposite order.

**WARNING!:** Don't disperse the washing residues in the environment!!

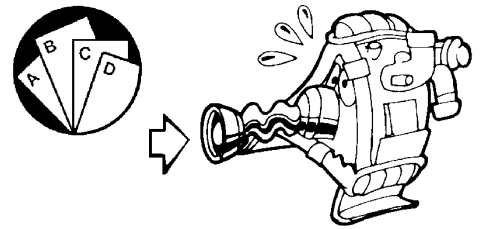

**FIG. 5**







Don't use the sprayer without having consulted the enclosed handbook

### GCP 3-way

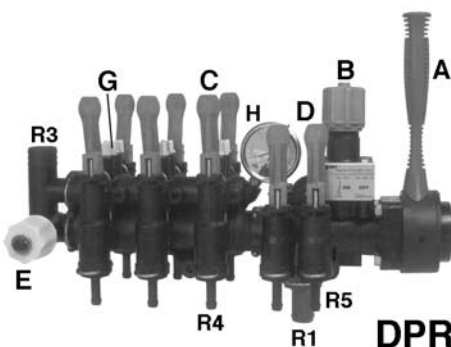
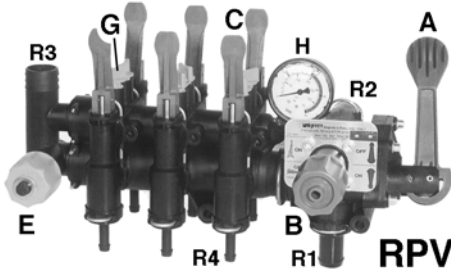
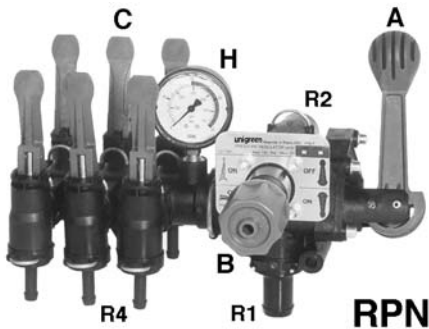

### RVA

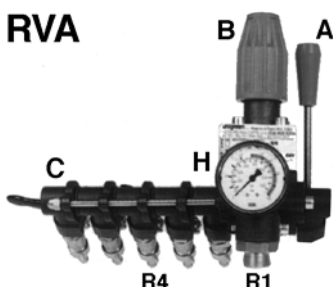

## 4.8 PRESSURE REGULATOR

To use the pressure regulator, follow the instructions in the enclosed handbook scrupulously. The pressure regulator controls all of the most important spraying functions, the thorough knowledge of its functions makes work easier and more precise.

The working pressure and the maximum pressure of the sprayer are determined by the pressure regulator which also protects the circuit from overpressure in any work conditions. (In serious but very rare cases, if the connecting pipes get blocked the pressure relief valve lets the pressure off) In some setups there may be a pump that can reach a pressure of 50 bar controlled by a regulator designed for 20 bar. In this case the maximum pressure that can be reached is 20 bar.

The regulators can be manual, mounted on the sprayer or at a distance to make the controls easier to use; or electrical with a control panel in the cabin. There are also regulator versions with mechanical remote controls with a cable. If the tractor has a waterproof cabin the use of electrical controls is obligatory.

### 4.8.1 COMPONENTS OF THE PRESSURE REGULATOR

Below you will find the indications for the main models fitted on Unigreen products.

**A main ON-OFF command:** "open" lets the fluid flow into the circuit in use; "closed" empties the tank.

**B maximum pressure valve:** adjusted by hand with the relevant knob (drains the excess liquid when the set pressure is reached).

**C boom section tap:** opens the corresponding boom or drains to the compensation regulator (G).

**D auxiliary tap:** can be used for various accessories (it is always manual).

**E volumetric pressure valve (proportional):**

(when present) it regulates the spraying pressure. The valve automatically compensates variations in speed (within the scope of the same gear ratio), keeping the quantity of liquid supplied per surface unit (litres/hectare) unchanged.

**F self-cleaning filter:** filters the delivery liquid.

**G compensation regulators:** suitably regulated, these make it possible to keep the pressure constant when one or more sections of jets is closed, they don't influence treatments with the boom fully open.

**H manometer:** indicates the working pressure.

Connections:

**R1** supply union

**R2** drain union

**R3** volumetric drain union

**R4** boom section delivery union

**R5** auxiliary delivery union

### Control box for ERGO and REMO electrical regulators

**I1** main control valve switch

**I2** volumetric pressure valve switch (proportional)

**I3** boom section valves switches

### 4.8.2 GENERAL INSTRUCTIONS

When using the pressure regulator, scrupulously observe the instructions in the enclosed handbook, below you will find generic indications for the major models fitted by Unigreen.

**All the regulation and adjustment tests must be carried out with clean water.**

### Pressure regulators without a volumetric valve (GCP3-way - RPN - RVA)

Adjusting the maximum pressure valve

= put main control **A** in the drain position ("OFF").

= loosen the hand wheel of maximum pressure valve **B** completely (anticlockwise).

= start the pump by activating the power-takeoff of the tractor at 540rpm

= open main control **A** (position "ON"), the manometer will be activated

= open all of the section valves **C** (position "ON")

= adjust maximum pressure valve **B** to the working value (in any case less than the safe maximum pressure the system can reach).

### Pressure regulators with a volumetric valve (RPN-DPR-ERGO-REMO)

Adjusting the maximum pressure valve

- = put main control **A** in the drain position ("OFF").
- = loosen the hand wheel of maximum pressure valve **B** completely (anticlockwise).
- = open volumetric valve **E** completely.
- = start the pump by activating the power-takeoff of the tractor at 540rpm
- = open main control **A** (position "ON"), the manometer will be activated
- = open the drain tap on filter **F** slightly (only ERGO and REMO)..
- = close volumetric valve **E** completely. If the pressure rises over the maximum limit of the system, make sure maximum pressure valve **B** is open (see previous indications)
- = open all of the section valves **C** (position "ON")
- = adjust maximum pressure valve **B** to a value over that of the working pressure (generally 10-14 bar) and in any case lower than the safe maximum pressure that the system can reach.

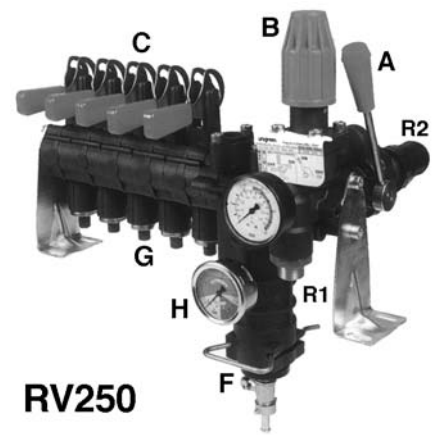

Adjusting the volumetric pressure.

- = with the volumetric pressure valve **E** adjust the pressure to the value the treatment will be done at (the pressure is indicated on the nozzles tables on the basis of the tractor speed and litres/hectare to spray)

**Warning! The working pressure must be adjusted with the volumetric valve and not with the maximum pressure valve. In the case the working pressure is too near to the calibrated pressure of the maximum pressure valve, the proportional valve may not be able to compensate the speed variations correctly.**

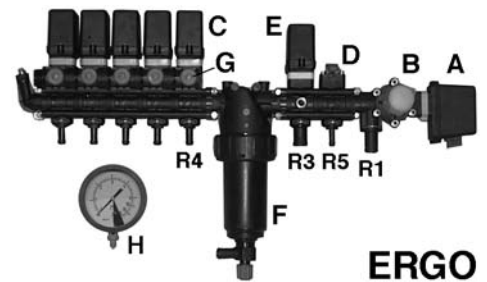

Adjusting the compensated returns

- = close only one tap of section **C** (position "OFF").
- = adjust the corresponding compensator **G** until you return to the pressure set previously (displayed on the manometer).
- = open and close the tap of section **C** and check that the pressure remains constant.
- = repeat the above operations for all the section taps.

If the types of nozzles aren't changed the regulations carried out will guarantee a constant spraying of the liquid also per treatments that are done at different working pressures.

NB: if the type of nozzle is changed then the calibrating will have to be done again.

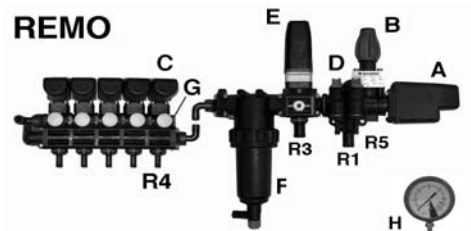

### 4.9 DELIVERY FILTERS (ONLY EQUIPPED MODELS)

Particularly useful when using small (low volume) nozzles.

In a central position with a manometer after the filter that shows any blockages in the cartridge. On the RVA version there is also a manometer before the cartridge to make it easier to find the problem.

The cleaning of the cartridge in the RPV-DPR-ERGO-REMO series is fully automatic (for ERGO and REMO see the previous paragraph), for the model RVA you should open the drain with the relevant lever (Fig. N° 6) for 2-3 minutes during the washing operations, as in the enclosed instructions.

You should clean the cartridge by hand periodically, on the basis of the product used. To clean, stop the pump. Wear rubber gloves and the other personal protective equipment when cleaning. Follow the instructions in the enclosed manual.

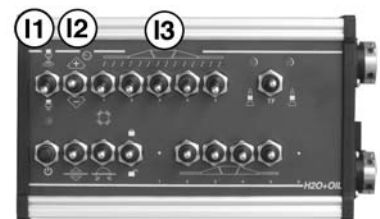

### 4.10 SPRAYING COMPUTER (OPTIONAL)

Scrupulously follow the instructions in the relevant manual when using.

We don't recommend using the sprayer with the computer until you have had at least one lesson from the UNIGREEN technicians.



FIG. 6

#### 4.11 FILLING THE TANK

The machines for defensive crop treatments, in consideration of the safety of persons, animals and the protection of the environment, must only be filled indirectly from open water courses and only by free-falling water from the waterworks.

The pipe used for filling must never come into contact with the liquid inside the tank and therefore the water must always fall over the upper edge of the filling inlet and through the filter installed on it.

The tank is fitted with a transparent graduated band that shows the exact quantity of liquid inside. This reading is precise if the tank is on flat ground; the actual total capacity coincides with the highest number. All the filling systems fitted by Unigreen on their production machines or on request are antipollution and stop the liquid overflowing out of the tank.



Level indicator and graduated band



##### a) FILLING WITH THE 3-WAY DEVIATOR (Fig. 7).

It is possible to fill the tank using the pump and the floating filter kit **G** (cod.1002/0080F) with 6 metres of rubber hose (the floating filter lets you always and only suck up clean water).

- = connect hose **T** to deviator **D** using the union hose adaptor supplied.
- = turn the lever of deviator **D** to the filling position.
- = place the other end of the hose, on which you fitted filter **G**, in the watering point.
- = start the power-takeoff leaving pressure regulator **C** in the draining position (you don't have to put the pump under pressure).
- = the filling speed in litres/minute is equal to the delivery of pump **P**.
- = visually check the level of the liquid in the tank and after filling stop the pump and put the lever of deviator **D** back in the working position.
- = disconnect pipe **T** from deviator **D**.



3-way deviator for filling tank

FIG. 7

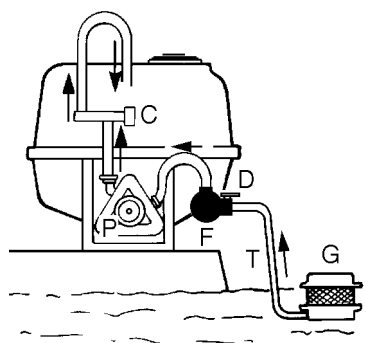

#### 4.12 MIXING

The active principle can be mixed using the relevant stirrers before and during the treatment. Correct mixing and stirring is the basis of the correct distribution on the crops. We recommend some useful accessories such as the premixer for powders and liquids (see the following paragraph).

To mix the product in the tank proceed as follows:

- a) high-pressure machines from 30 to 60 bar (FIG. N° 8a): run the stirrer (RED tap) or the ejector (GREEN tap) for roughly 10-15 minutes at the maximum pressure available
- b) low pressure machines, max 20 bar
  - = with a drilled pipe on the drain, run the pump at roughly 540 RPM with the pressure regulator on drain for at least 10-15 minutes. (FIG. N° 8b)
  - = with the stirrer on a delivery, run the pump supplying the stirrer (or ejector) at the maximum pressure available for at least 10-15 minutes. (FIG. N° 7)

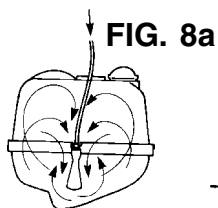

FIG. 8a

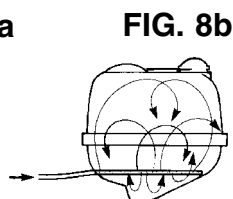

FIG. 8b

<b>COLORI IDENTIFICATIVI RUBINETTI</b> Tap identifi cation colours Couleurs pour identif er les robinets Farbe un Die Hähne zu identif zieren Colores identif cación grifos	
<b>AGITATORE</b> Agitator - Agitateur Ruhrwerk - Agitador	
<b>EIETTORE</b> Ejector - Ejecteur Ejektor - Eiecteur	
<b>PREMISCELATORE</b> Premixer - Pré-mélangeur Vormischer - Premezclador	
<b>LAVACISTERNA</b> Tank-rinsing - Lave-reservoir Behälterwaschung-düse Limpia-deposito	



##### 4.12.1 MANUAL PREMIXING

Dilute the active principle by hand before introducing it into the tank, (you must wear suitable protective clothing such as rubber gloves, a mask or goggles, overalls, etc.).

##### 4.12.2 PREMIXER ON COVER (OPTIONAL):

Open the cover and pour all of the chemical powder into the filter, close the cover and open the supply tap until all of the powder has dissolved.

WARNING: using the taps on the pump or in any case on the front of the machine puts the operator near the cardan shaft. Despite the presence of CE standard protective covers you should take great care.



### 4.12.3 PREMIXER ON HOPPER WITH TIN WASHER (OPTIONAL)

Campo 22-32 machines come equipped with the TOP-MIX S-41 premixer (FIG. No. 10); this version of the premixer allows independent adjustment of pressure knob, avoiding having to change the work settings of the machine every time you have to do the premixing.

To mix the product in the tank proceed as follows:

- = turn the lever of the delivery deviator to the TOP-MIX position as shown in the pictogram on the machine.
- = adjust Top-Mix pressure to approximately 10-12 bar by turning control M (the manometer allows you to check the actual pressure)
- = press lever 4 for a few seconds introducing 3-4 litres of water into the hopper.
- = open the premix, overturning the cover as shown in the photo and introduce the product to mix into the hopper 1, close the cover again.
- = press lever 4 to mix the product in the hopper, watching the level of the liquid which could overflow. To prevent overflowing and to help powder products dissolve, open tap 6) to drain into the tank.
- = after emptying, close tap 6.

To wash the tin, proceed as follows:

- = open the premix, overturning the cover as shown in the photo
- = supply the premix using the control to regulate a pressure to under 3-4 bar
- = introduce the tin into the hopper, insert washing pipe 2 into the tin, press the tin onto the pipe until it has been completely washed.
- = open tap 6 to drain into the tank at the same time.
- = after emptying, close tap 6.

**NB:** If the tin washer isn't supplied with clean water and isn't fitted with the optional electrical pump, you must rinse again by hand with clean water.

THE LIQUIDS USED FOR RINSING SHOULD BE INTRODUCED INTO THE TANK AND BE SPRAYED ON THE FIELD.

At the end of the operations, wash the hopper:

- = check that the cover and all the taps of the premix are closed and open the supply tap on the sprayer, delivering liquid at a pressure of roughly 10-12 bar (never exceed 15 bar).
- = open safety tap 10.
- = press lever 4 to activate jets 3 and 9, watching the level of the liquid which could overflow. To prevent overflowing, open tap 6) to drain into the tank.
- = after washing, release lever 4 and close taps 6 and 10.

**NB:** At the end of all of the operations put the lever of the deviator back into the work position.

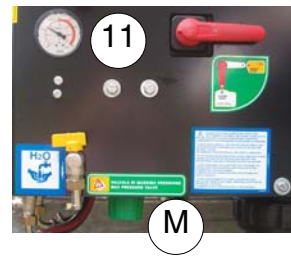

Deviatore Top Mix

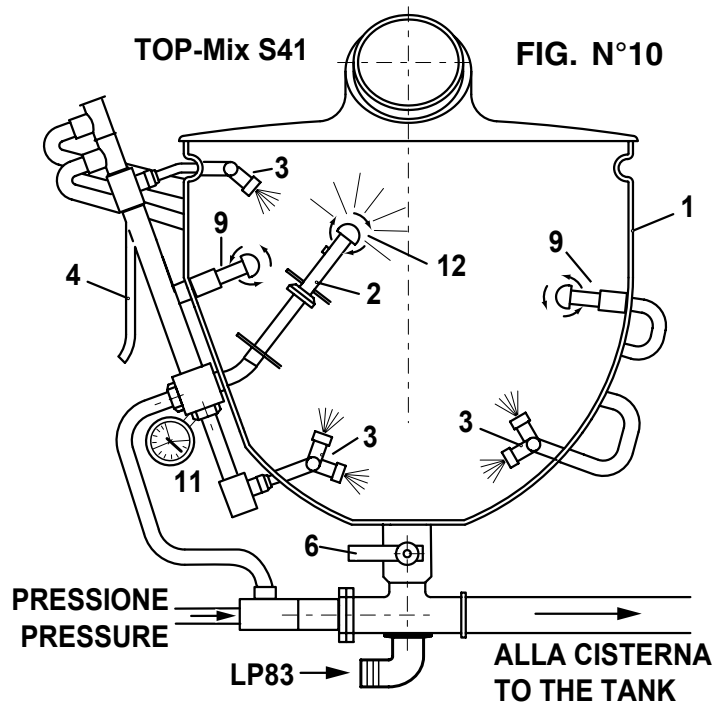



TOP-MIX S41(Campo 11-16-22E)



#### 4.12.4 TOP-MIX PREMIXER FOR CAMPO 11-16-22E (OPTIONAL)

The Top-Mix S41 premixer is also available for Campo 11-16-22E machines as an optional feature.

Its operation is slightly different from the standard version on Campo 22-32 machines; this version of the premixer maintains an independent pressure setting, eliminating the need to change the machine's operating calibration every time one has to premix.

The differences with the version described above have to do with the calibrated nozzle (see paragraph 4.12.5) and the manometer on the premixer.

The TOP-MIX version for Campo 11-16-22E should be used as follows:

- push the lever of the delivery deviator to the TOP-MIX position as illustrated on the machine.
- keep the pressure of the Top-Mix at approximately 9-12 bar by adjusting the speed of the cardan shaft (the manometer allows you to check the actual pressure)
- to mix and to wash the tin, proceed as indicated in the paragraph above.

**NB: At the end of all of the operations put the lever of the deviator back into the work position.**

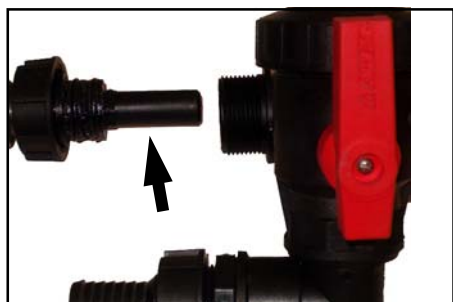

Esempio di montaggio dell'ugello calibrato

#### 4.12.5 TOP-MIX CALIBRATED NOZZLE FOR CAMPO 11-16-22E

The TOP-MIX S41 premixer comes with a delivery calibration nozzle mounted on the lower block (see photo to the side); two standard nozzles are supplied, to be mounted depending on the pump:

Comet pumps BP125-BP151-BP171-BP205 = Ø7.5 nozzle

Comet pumps BP235-BP265-BP280-BP305 = Ø10 nozzle

NOTE: when the Top-Mix is in use with the BP305 pump, pump speed must be limited to 400 rpm.

For pumps from other manufacturers, refer to the equivalent delivery.



#### 4.12.6 HOW TO USE THE LP83 INCORPORATOR

The TOP-MIX S41 premixer comes with an LP83 chemical incorporator, which makes it possible to suck the product up directly from the container.

It is used as follows:

- turn pressure on in TOP-MIX premixer (see paragraph above)
- turn lever **6** down and suck the product up.
- the product is suctioned, mixed with water under pressure, and directly incorporated in the tank of the machine.
- after incorporating the product in the tank, lift lever **6** back to a horizontal position.

NOTE: To wash the incorporator, put it in the premixer for a few seconds, performing the hopper washing operations described in paragraph 4.4.



#### 4.13 WASHING THE SPRAYER

Thoroughly wash the machine after each treatment pumping clean water through the circuit and clean the suction and delivery filters.

Warning: Dirty equipment is very dangerous for the people and environment. Discharging the residues of washing in the environment without taking precautions is forbidden as this pollutes watercourses. Distribute the residues on the treated field.

WARNING: The tank washing is controlled by tap N. 1, premix N. 2 and stirrer N. 3.

##### 4.13.1 CIRCUIT WASHER AND TANK WASHER

CAMPO machines can be equipped with with a circuit washer tank (FIG. 11). This tank must be filled with clean water and used to rinse the entire circuit including the suction, delivery, pump, pressure regulator, jets and nozzles. Thanks to the practical rotary nozzle it also rinses the inside surfaces of the tank.

NB: To completely clean the tank and the pipes of any residues of the various active principles, we recommend adding 2kg of soda to the washing liquid for every 100 L of water.

At the end of the treatment, wash the circuit and the tank.

- Stop the diaphragm pump disengaging the power-takeoff.
- Check you have filled the circuit washer tank (C).
- Make sure the main control of the pressure regulator is OFF and that all the boom sectors are closed.
- Turn suction deviator A to the circuit washer position (H2O).
- Start the diaphragm pump by engaging the power-takeoff.
- Increase the engine speed until all of the liquid in circuit washer tank C has been sucked up.
- Turn the diaphragm pump off and turn deviator A to the work position (TANK).
- Turn the main control to ON, so there is pressure in the circuit.
- Start the diaphragm pump again and use the tank washing tap (BLUE) on the regulator (or on pump) that supplies jet B.
- After a few minutes you can close the tank washing tap
- Distribute the washing residues over a portion of the field where it won't cause damage.
- After you have finished washing, stop the diaphragm pump.

NB: at the end of the washing cycle, if there is the risk of frost, pour roughly 500 grams of normal antifreeze for auto vehicles into the tank.

##### 4.13.2 WASHING WITH FULL TANK (OPTIONAL)

CAMPO machines can be equipped with a discharge deviator that makes it possible to wash the pump and circuit even with a full tank.

- Stop the diaphragm pump by disengaging the power-takeoff.
- Check that you have filled the circuit washing tank (C).
- Check that the main control of the pressure regulator is OFF and that all the boom sectors are closed.
- Turn discharge deviator S to the WASH position
- Turn suction deviator A to the circuit washer position (H2O).
- Start the diaphragm pump by engaging the power-takeoff.
- Increase the engine speed until all of the liquid in circuit washer tank C has been sucked up.
- After 1-2 minutes, turn the main control to ON, so there is pressure in the circuit.
- Open the section taps to spray the liquid in circuit washer tank C.
- Distribute the washing residue over a portion of the field where it will not cause damage.
- After you have finished washing, stop the diaphragm pump.

NOTE: Before using the machine again for spraying, turn taps A and S back to the correct operating position

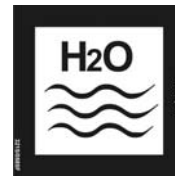

Questo simbolo identifica la cisterna di acqua pulita ad uso lavacircuito presente sulla macchina

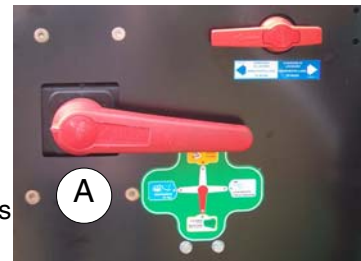
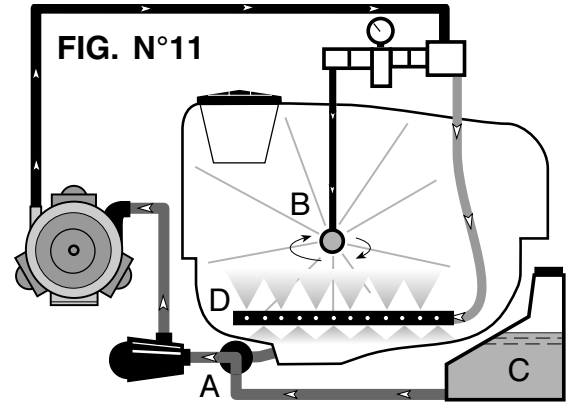

Suction deviator Campo 22-32



Tank washing tap (BLUE)



Suction deviator Campo 11-16-22E

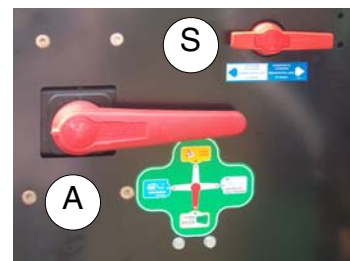

Suction and discharge deviators Campo 22-32

## 5 HORIZONTAL BOOMS FOR HERBACIOUS CULTIVATIONS

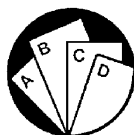

### 5.1 HYDRAULIC HERBICIDE BOOMS

These are made in of steel painted with epoxy paint or hot galvanised. The jet booms are made of stainless steel with the jets mounted normally ever 50 cm. All of the booms are folded onto the central body and the external arms have safety joints to prevent breakages.

In the case of a knock the boom bends to avoid the obstacle and normally returns to the working position automatically. In any case the operator should try to avoid knocking against objects as this could damage both the boom and the obstacle in time; all the more so if the two elements get stuck.

Check that no one and nothing is in the area where the booms will open; particular attention should be paid to the presence of any electric power lines.

**WARNING: limit movements when in proximity of power lines so as not to exceed a height of 4 meters.**

The hydraulic plant can be fed from the hydraulic pump of the tractor or be fully independent.

- The hydraulics are controlled by a hydraulic distributor with mechanical or electro-hydraulic controls and switches in the cabin.

- All of the controls on both versions are sustained action controls and each lever or switch has a pictogram of the relevant operation it controls.

See the enclosed handbook for instructions on the use of the electrohydraulic version (Elettroil).

**WARNING:** with hydraulic booms, don't stand in the range of action of the machine.

Pay attention to the integrity and efficiency of the hydraulic components and in particular to the pipes to prevent the risk of bursting.

Do a full check on the pipes and components at least once a year, we recommend replacing hydraulic pipes every 3-4 years.

#### 5.1.1 INDIPENDENT HYDRAULIC PLANT

In this case there is a tank, a filter and a hydraulic pump fitted with a flange behind the main pump of the sprayer.

**IMPORTANT:** The entire plant is designed to be used at 540 RPM. Periodically check the oil level in the tank and avoid filling it over 3/4 full as the oil might overflow.

The tank has a filler cap with a breather, when the need arises (for repairs or to replace a component) you can drain the oil by disconnecting the suction pipe of the pump and collecting the oil in a recipient.

**WARNING:** the oil used mustn't be dispersed in the environment and must be collected in the relevant containers.

#### 5.1.2 OIL FEED FROM TRACTOR

Consult the use and maintenance manual of the tractor.

Connect the delivery and discharge quick-fit coupling to the respective connections, respecting the direction of flow.

= On booms that have a direct connection to the quick-fit couplings, each pair of couplings feeds a cylinder.

= For booms equipped with EDR electro-deviators, follow the diagram of the couplings supplied.

= For manual or electric distributors (Elettroil), the distributor inlet pipe is connected to the aluminium flow separator valve next to the distributor (see photo).

The flow separator must be adjusted correctly so it send less than 4-5 L/1° to the distributor.

To prevent the cylinders moving at a dangerous speed, adjust the relevant chokes near the cylinders. If the registration ring nuts aren't visible then fixed chokes are fitted. The chokes are fitted on the discharge line of the movement to slow.

Any impurities in the oil could block the chokes and as a consequence block the cylinder; remove the dirt if necessary.

The maximum pressure valves of the distributors are regulated to a pressure of around 150 bar.

To prevent the excessive heating of the oil we recommend supplying the

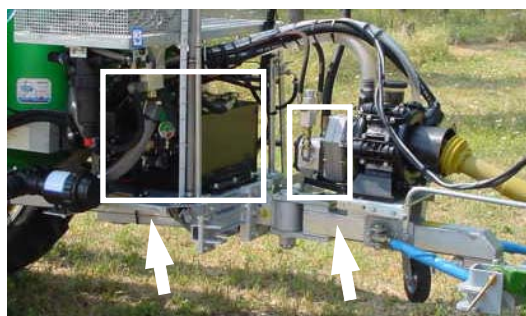

Tank

Hydraulic pump



Oil level

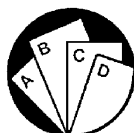

Elettroil connection to quick-fit couplings of the tractor



distributor of the sprayer only when the cylinders are being used. We recommend having qualified personnel do any adjustments.

## 5.2 AIR-ASSISTED BOOMS

These are booms that use air to make the treatment more effective and decrease wind drift.

They are equipped with a fan (normally hydraulic) and an AIR-SLEEVE that transports the airflow along the entire length of the boom.

They come with their own use and maintenance handbook, enclosed with the machine.



Air-assisted booms

## 5.3 SELF-LEVELING DEVICES

The self-levelling device keeps the boom parallel to the ground to be treated. It works thanks to the effect of gravity in all the models (except TDL). The oscillation can be blocked mechanically (TDE-TDM) or hydraulically (TDI). The Work boom has a self-levelling device with an automatic block based on cables and springs.

The self-levelling device only works on flat ground, for hilly terrain we recommend the version with trim corrector (TDI 2P) or hydraulic LEVELING (TDL), which lets the operator position the boom with an inclination that is suitable for the ground.

To use, check:

- a)** that the boom has been mounted in the centre, the weight of the boom must be supported equally on the two halves. To check this, free the self-levelling device from the mechanical (or hydraulic) block and by moving the boom make sure it automatically adjusts its position to be parallel to the ground.
- b)** in the models that have an adjustable connecting rod, by adjusting the same, it is possible to obtain small variations in trim that can be useful on slightly uneven terrain.
- c)** in the hydraulic versions it is possible to fit a hydraulic cylinder (TDI 2P) instead of the connecting rod that is adjusted by hand.
- d)** to complete the self-levelling device we recommend the dragging jet-saver protections
- e)** keep the sliding parts well greased.



Self-levelling



Self-levelling blocking system

### 5.3.1 VARIABLE GEOMETRY

Some models of hydraulic boom are equipped with a variable geometry system of the side arms for independent inclination, this system can be used as an alternative to the trim correction or combined with the same.

The angle of the arms is controlled by the operator with electrohydraulic controls.

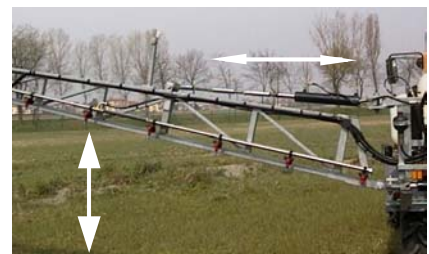

Variable geometry



Sistema di Sollevamento ed Autolivellamento

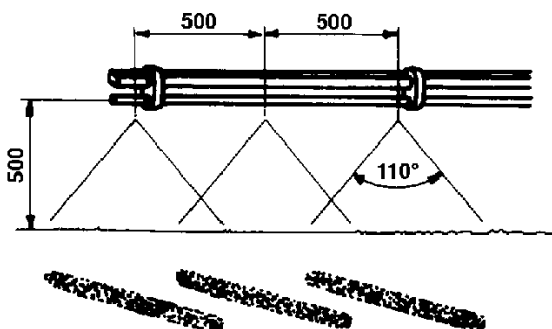
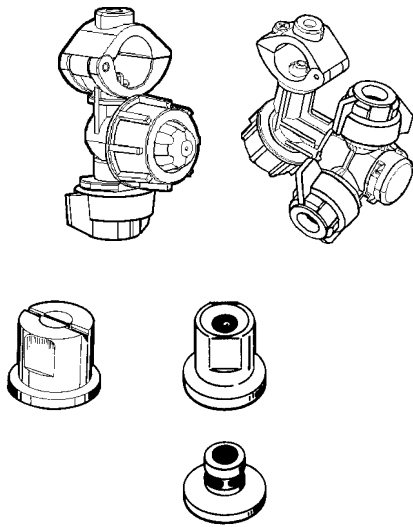

#### 5.4 LIFTING

The lifting devices are very useful to adjust the height of the boom on the basis of the height of the vegetation to be treated.

The height of the boom is adjusted as follows:

- = the hydraulic version has a double-effect cylinder controlled by a special parachute stop valve.
- = to lift and lower the boom use the control on the elettroil pushbutton panel or the quick-fit couplings connected to the lifting cylinder.
- = periodically lubricate the sliding guides with grease and check the guide bolts are tightened properly, with a suitable play.

#### 5.5 DISTRUBUTION WITH HERBICIDE BOOM

##### 5.5.1 DESCRIPTION OF TYPE OF JETS

Various types of jets are fitted; with a single fixed (threaded or quick-fit) or with multiple heads.

Generally they have a non-drip diaphragm and are made out of reinforced plastic, suitable for pressures up to 15-20 bar, some models are nickel plated brass for pressures up to 40 bar. There are versions with 2-3-4 plastic nozzle heads and 2 brass heads.

##### 5.5.2 DESCRIPTION OF TYPE OF NOZZLES

The nozzles are extremely important to obtain a correct distribution on the vegetation to be treated. Poor quality or worn nozzles have a tendency to create unevenly treated strips.

The nozzles are produced in various sizes, to work with a precise pressure range, to create certain types of larger or smaller drops; using nozzles for a purpose they are not envisaged for prejudices the precision and duration of the nozzles.

###### a) Fan nozzles

Available in various materials: plastic-brass-stainless steel-ceramic. They are used at pressures from 1-5 bar producing medium-large drops; particularly suitable for pre-emergency and post-emergency weeding.

###### b) Conical nozzles

Generally made of ceramics, these nozzles consist of two parts; the actual nozzle and the slinger. They are particularly resistant to wear and designed to work from 1 to 16 bar producing a high density of small drops with a strong turbulence. This turbulence makes them suitable for penetrating luxuriant vegetation and so they are suitable for fungicides and insecticides. When necessary they can also support slightly higher pressures.

###### c) Anti-drift nozzles

There are various models of nozzles that make it possible to reduce the effect of drift.

###### d) Mirror nozzles for liquid fertilizers.

##### 5.5.3 DISTRUBUTION

a) Check that all the nozzles are in a good condition and are positioned correctly on the boom. The automatic positioning with quick heads is done for threaded heads with the relevant adjustment wrench.

Check that the total capacity of the nozzles is at least 25% less than the capacity of the pump.

b) Make sure the suction and delivery filters, as well as the non-drip membranes are clean and in a good condition and that the same quantity of liquid is supplied along the entire width of the boom.

c) Check that the height of the boom from the crops is suitable for regular distribution. For a boom with fan nozzles fitted at 50 cm from each other; this height is roughly 50 cm.

###### d) Working pressure.

The working pressure must allow for the indications in points 5.5.2 and the following of this handbook and also allow for the speed of the tractor to obtain the desired spraying in litres/hectare.

To assess the data, consult tables N° 1-2.

These tables are valid for spaces between the nozzles of 50cm.

To meet particular requirements UNIGREEN can supply booms with different spaces between the nozzles and setups suitable for running at pressures over 20 bar.

See the table below for the data conversion.

<b>OTHER SPACING (Cm)</b>	75	60	50	45	42,5	40	35	33	30
<b>CONVERSION FACTOR</b>	0,666	0,833	1,000	1,111	1,176	1,250	1,428	1,515	1,666

#### USEFUL INFORMATION

During the distribution of the product watch the pre-established speed and pressure, following the data in the nozzles table.

The tables indicate the volume distributed per hectare for each type of nozzle at the desired speed and pressure and are calculated as follows:

$$V=600xQ / l x V$$

**where:** V=volume to distribute (L/HA)

Q=capacity of the nozzle (L/MIN)

l=distance between the nozzles in metres (0.5)

V = tractor speed (Km/h)

**e)** Considering the wear of the nozzles and a possible pressure drop in time, to check them proceed as follows:

With the pump running at the pre-established pressure, measure the quantity of liquid that comes out of the nozzles in L/min. Multiply this by the figure in the table indicated below corresponding to the chosen treatment speed. The resulting figure is the exact quantity of liquid to distribute per hectare.

<b>THIS GOES FOR A DISTANCE BETWEEN THE NOZZLES OF 0.5m</b>	<b>Km / hour</b>	2	3	4	5	6	7	8	9	10	11	12
	<b>VALUE</b>	600	400	300	240	200	172	150	133	120	109	100

**EXAMPLE:** the nozzle delivers 2.2 L. per minute. The speed chosen for the treatment is 6 km/h, the quantity to distribute per hectare is  $2.2 \times 200 = 440$  L/ha

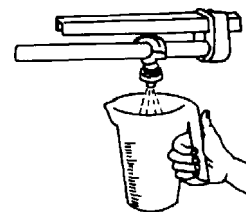

**f )** For a quick and immediate spraying check use QUICK CHEK (code **5030/0174F** )





Marker

### 5.6 MARKER

The marker indicates the zone where the treatment has been applied. It produces a chemical foam that doesn't damage the crops, which is deposited on the ground and disappears after roughly an hour. The marker is an accessory available on request. For the use and maintenance of the system follow the instructions in the specific handbook in the package or enclosed with machine manual.

**WARNING:** the foam liquid is ruined by frost, very hard water can change the yield and function.

## 6 HAND LANCES

When using hand lances bear in mind the following notes:

= Don't direct the jet of liquid towards electric power lines or zones where there is electrical current, houses or where people might pass.

= Don't point the jet at people or animals.

The jet can cause serious injuries simply due to the mechanical force of the liquid under pressure.

= Never block the spraying lever of the lance in an open position because if the lance falls it will be uncontrollable.

= At the end of work after you have stopped the pump, make sure that any residual pressure in the pipes under pressure has been drained to avoid unexpected jets when putting the lance away.

There are various types of lances; with a lever, mitra spray gun and pistol grip.

For further information please refer to the handbook in the package.

The lever lance is controlled by opening lever A which, depending on how much it's pressed, produces a conical spray or direct jet. The standard nozzle is  $\varnothing$  1.5

The mitra spray gun can produce a direct jet or a conical spray and the type of spray is selected by pushing lever B forwards or backwards. Use lever C to open the jet. The standard nozzle is  $\varnothing$  2.5

Replacement nozzles are available for all of the lances and the capacities are indicated in the tables N° 3 e N° 4.

## 7 HOSE REEL

Available in the following sizes 20-50-100 , with mechanical, electrical and hydraulic rotation.

To use the system, consult the enclosed handbook as there are significant differences between each.

After work it is important to block the winding roller to stop the hose unwinding while you are moving the sprayer.



## 8 MAINTENANCE

(To be done with the machine and cardan shaft stopped)

The maintenance of the sprayer is essential for maintaining a high level of safety. Also consult the single handbooks of the main components of the sprayer. All of the maintenance operations and repairs must be carried out with the machine and cardan shaft stopped and the tank and circuit clean of any residues of chemical products.

### 8.1 PROGRAMMED MAINTENANCE

(TAB. N° 7)

We recommend using a table of programmed maintenance to follow in time to keep the sprayer in an efficient working condition.

For major and important maintenance jobs we recommend using the normal UNIGREEN assistance service available from your reseller, using original UNIGREEN spare parts.

### 8.2 ROUTINE MAINTENANCE

= After every treatment, wash the inside of the tank and the entire circuit as indicated in paragraph 4.13

= Periodically check that the suction and delivery filters are clean (see figure)

= Check the oil level in the volumetric compensator of the pump, as indicated in paragraph 5.1.1

= The use of chemical products that are particularly damaging for a nitrile rubber mix (ex.. herbicides and products for rice fields) can cause the diaphragm to break before time.

In these conditions check the state of the components more often.

### 8.3 EXTRAORDINARY MAINTENANCE

At the end of a season of intense use, or every two years of normal use, it is a good idea to have a specialised service technician perform a general check on the machine.

### 8.4 MAINTENANCE OF THE HERBICIDE BOOM - SELF-LEVELLING DEVICE - LIFTING SYSTEM

(to be done with the machine and cardan shaft stopped)

**a)** Check the state of wear of the nozzles and replace them when the delivery is over 30-35% of the theoretical level. Don't clean with nails, bradawls or punches. Use small brushes or compressed air.

- drain the pressure and stop the machine

- dismantle the screw or bayonet ring nuts holding the nozzles

- clean with a small brush or compressed air, don't use nails, punches or bradawls

- reassemble the nozzles and the ring nuts, replacing the filters and seals.

**b)** Keep the joints greased.

**c)** If you are using the boom and you notice excessive pitching or the same closing on sloping ground, you can load the spring more by screwing in the relevant nut.

**d)** If the external arms droop downwards after some use you can realign them using the relevant adjustment screws:

- unscrew the locknut

- adjust the inclination by screwing in the screw

- tighten the locknut again to stop it unscrewing accidentally.

### 8.5 REPAIRS

We recommend having the normal UNIGREEN assistance service available from our reseller perform any repairs or contact a specialised workshop. During all of the repairs, in particular when welding, the machine and the circuit must be clean of any residues of chemical product.

If the machine has to be lifted (for example to change a wheel) follow the instructions in point 4.3 of the present handbook.

Also make sure the machine is stopped, connected to the tractor, and use the relevant chocks to block the wheel still on the ground.

If you use a jack (manual or hydraulic) make sure you use a jack that is suitable for the frame so it can't slip and put it in the right position. The jack must be placed under the main frame of the machine near the wheel to change. Make sure the ground is compact: if necessary use wooden beams or other sufficiently resistant material to broaden the supporting base of the jack.

### 8.6 STORAGE IN A WAREHOUSE AND TRANSPORTATION

The sprayer must be kept in a closed place away from excessive humidity and protected from frost. Especially if electrical pressure regulators, electrical motors, a spraying computer or similar components are fitted.

Before storing the machine, after you have washed it, apply a light coat of oil.

If the temperature might drop to below zero, drain any residual liquid or add roughly 0.5 L of normal antifreeze for auto vehicles.

To transport the machine follow the instructions in point 4.3 of the present handbook.

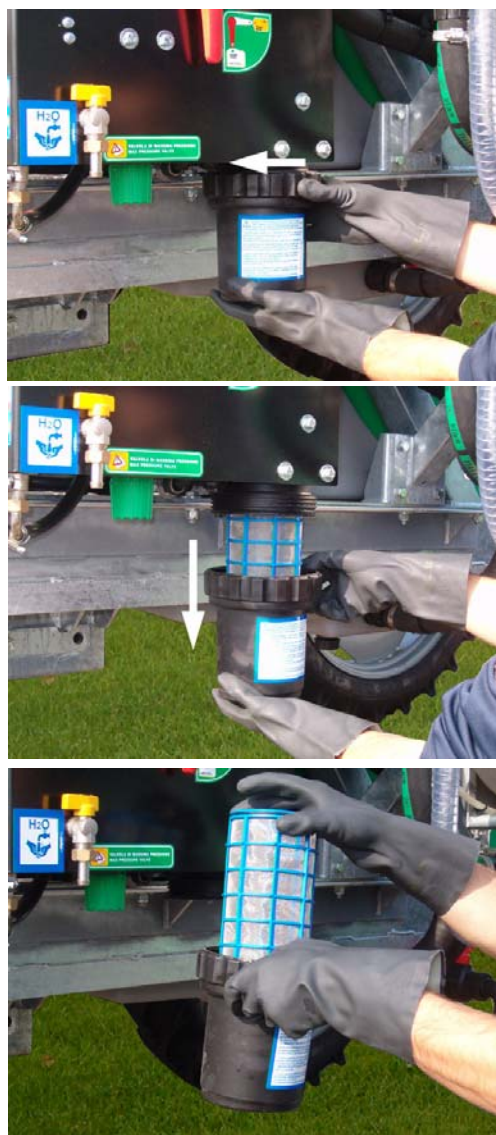

Dismantling the Suction Filter

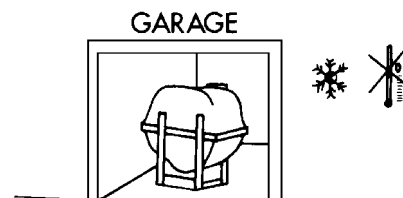



### 8.7 PUTTING BACK INTO SERVICE AFTER WINTER LAYUP

Before using the machine again after a long period of inactivity you should perform some general checks, following the instructions in point 4.4 and drain any antifreeze.

**Never start the shaft of the pump if you think there may be ice inside. To check this, make sure you can turn the shaft by hand without connecting it to the tractor.**

After you have connected the machine to the tractor (see point 4.5) following the instructions in the present user's handbook and in the enclosures of the pump, pressure regulator and accessories.

### 8.8 DEMOLITION AND DISPOSAL

When the sprayer will be put out of service you should wash it with great care to remove any residues of chemical product, follow the instructions in point 4.13 of the present handbook.

ATTENTION: It is necessary to adopt appropriate Individual Protection Devices in manipulating waste.

The disposal of waste deriving from the demolition of the machine must be carried out respecting the environment, avoiding soil, air and water pollution.

Local legislation in force in the matter must be respected in any case.

Remember that waste is understood as any substance or object that enters into the categories shown in attachment A in part IV of Legislative Decree 152/2006, that the holder has destroyed, has decided or is obliged to destroy.

Waste deriving from the demolition of the machine is classifiable as special waste.



#### 8.8.1 MATERIALS FOR DEMOLITION

Non-dangerous special waste is that which can be recovered, according to the February 1998 Ministerial Decree:

- Iron, aluminium, stainless steel and copper materials
- Plastic materials
- Electronic cards
- Hydraulic oil
- Electrical plant

#### 8.8.2 INDICATIONS FOR A SUITABLE TREATMENT OF WASTE

The Correct management of special waste envisages:

- stocking in suitable places, avoiding mixing dangerous waste with the non-dangerous.
- ensuring that authorised carriers and receivers carry out its transport and disposal/recovery.

Transport of one's waste to authorised collection centres is allowed exclusively if you are enrolled in the Environmental Management Register.

#### 8.8.3 ELECTRICAL AND ELECTRONIC APPARATUS WASTE (EEAW)

The Italian government has adopted the European Parliament directives in the matter of the disposal of electrical and electronic waste (EEAW) (2002/95/CE and 2003/108/CE Directives) with Legislative Decree n° 151, July 25 2005).

The measures: in particular, the decree established measures and procedures aimed at:

- a) forestalling the production of EEAW;
- b) promoting the re-use, recycling and other forms of EEAW recovery, in order to reduce the quantity to send for disposal;
- c) improving, in terms of the environment, the actions of the subjects who participate in the life-cycle of these apparatuses (producers, distributors, consumers and operators directly involved in the treatment of EEAW);
- d) reducing the use of dangerous substances in electrical and electronic apparatus.

The decree imposes the limitation and elimination of several substances present in EEAW: lead, mercury, cadmium, chrome, hexavalent chrome, polybrominated biphenyl, polybrominated diphenyl and polybrominated diphenyl ethers.

The machine has been designed and created in conformity with this directive. Follow the indications shown below.

The symbol to the side, showing a barred garbage can on wheels, indicates the separate collection of the electrical and electronic apparatuses of the machine.



The user of the present machine can contact the collection centres instituted by the Local Authorities or the UNIGREEN Company directly, or request withdrawal by the dealer, in order to carry out correct disposal of the waste.





**Caratteristiche ugelli a ventaglio ISO (portata in Litri/ettaro, con distanza getti 50cm., alla velocità indicata)  
ISO fan nozzles tips specifications (delivery in Lt./ha, with nozzles distance 500 mm., at the stated speed)**

Pressure in bar	ISO - 01 ARANCIO-ORANGE					ISO - 015 VERDE - GREEN					ISO - 02 GIALLO - YELLOW					ISO - 03 BLU - BLUE					ISO - 04 ROSSO - RED					Pressure in bar										
	Portata in litri/1'	Km/h/Km/h	Km/h/Km/h	Km/h/Km/h	Km/h/Km/h	Portata in litri/1'	Km/h/Km/h	Km/h/Km/h	Km/h/Km/h	Km/h/Km/h	Portata in litri/1'	Km/h/Km/h	Km/h/Km/h	Km/h/Km/h	Km/h/Km/h	Portata in litri/1'	Km/h/Km/h	Km/h/Km/h	Km/h/Km/h	Km/h/Km/h	Portata in litri/1'	Km/h/Km/h	Km/h/Km/h	Km/h/Km/h	Portata in litri/1'		Km/h/Km/h	Km/h/Km/h	Km/h/Km/h	Portata in litri/1'	Km/h/Km/h	Km/h/Km/h	Km/h/Km/h	Portata in litri/1'	Km/h/Km/h	Km/h/Km/h
2	0,32	77	64	55	48	43	38	0,48	115	96	82	72	64	58	0,65	156	130	111	97	86	78	0,97	232	194	166	145	129	116	1,28	307	256	219	192	170	153	2
2,5	0,36	86	72	62	54	48	43	0,54	130	108	93	81	72	65	0,73	175	146	125	109	97	87	1,08	259	216	185	162	143	129	1,43	343	286	245	214	190	171	2,5
3	0,39	94	78	67	58	52	47	0,59	142	118	101	88	79	71	0,80	192	160	137	120	106	96	1,19	285	238	203	178	158	142	1,57	376	314	269	235	209	188	3
3,5	0,43	103	86	74	64	57	52	0,64	154	128	110	96	85	77	0,87	208	174	149	130	115	104	1,28	307	256	219	192	170	153	1,70	408	340	291	255	226	204	3,5
4	0,46	110	92	79	69	61	55	0,68	163	136	117	102	91	82	0,93	223	286	159	139	123	111	1,37	328	274	234	205	182	164	1,82	436	364	311	273	242	218	4
4,5	0,48	115	96	82	72	64	58	0,72	173	144	124	108	96	86	0,98	235	296	167	147	130	117	1,45	348	290	248	217	193	174	1,93	463	386	330	289	257	231	4,5
5	0,50	120	100	86	75	66	60	0,76	182	152	131	114	101	91	1,04	249	208	178	156	138	124	1,53	367	306	262	229	203	183	2,03	487	406	347	304	270	243	5
2	1,61	386	322	276	242	215	193	1,91	458	382	327	286	254	229	2,58	619	516	442	387	344	310	3,25	780	650	557	448	433	390	4,83	1158	966	828	725	644	580	2
2,5	1,80	432	360	309	270	240	216	2,14	513	478	366	321	285	256	2,88	691	576	494	432	384	346	3,61	888	722	619	542	481	433	5,40	1296	1080	926	810	720	648	2,5
3	1,97	473	394	338	296	263	236	2,34	561	468	401	351	311	280	3,16	758	632	542	474	421	379	3,95	848	780	677	593	527	474	5,92	1421	1184	1015	888	789	710	3
3,5	2,13	511	426	365	320	284	256	2,53	607	506	433	379	337	303	3,41	818	682	584	512	455	409	4,27	1025	854	732	641	569	512	6,39	1534	1278	1095	859	767	687	3,5
4	2,28	547	456	391	342	304	274	2,71	650	542	464	406	361	325	3,65	876	730	626	547	487	438	4,56	1094	912	782	684	608	574	6,84	1642	1368	1173	1026	912	821	4
4,5	2,35	564	470	404	352	313	282	2,87	688	574	491	430	382	344	3,86	926	772	662	579	515	463	4,83	1159	966	828	725	644	580	7,25	1740	1450	1243	1088	967	870	4,5
5	2,50	600	500	430	375	332	300	3,03	727	606	516	454	403	363	4,07	977	814	698	610	543	488	5,10	1224	1020	874	765	680	612	7,64	1834	1528	1310	1146	1019	817	5



TAB.2 CHARACTERISTICS NOZZLES CONICAL ISO



Caratteristiche ugelli a cono ISO (portata in Litri/ettaro, con distanza getti 50cm., alla velocità indicata)  
 ISO cone nozzles tips specifications (delivery in Lt./ha, with nozzles distance 500 mm., at the stated speed)

Pressione in bar Pressure in bar	<b>TXA - TR 005</b> LILLA - LILLA										<b>TXA - TR 0067</b> VRDE OLIVA - OLIVE GREEN										<b>TXA - TR 01</b> ARANCIO - ORANGE										<b>TXA - TR 015</b> VERDE - GREEN																																								
	Portata in litri/1 Delivery litres/1		Km/h		Km/h		Km/h		Km/h		Km/h		Km/h		Km/h		Km/h		Km/h		Km/h		Km/h		Km/h		Km/h		Km/h		Km/h		Km/h		Km/h		Portata in litri/1 Delivery litres/1		Portata in litri/1 Delivery litres/1		Portata in litri/1 Delivery litres/1		Portata in litri/1 Delivery litres/1																												
	5	6	7	8	9	10	5	6	7	8	9	10	5	6	7	8	9	10	5	6	7	8	9	10	5	6	7	8	9	10	5	6	7	8	9	10	5	6	7	8	9	10	5	6	7	8	9	10	5	6	7	8	9	10	5	6	7	8	9	10	5	6	7	8	9	10	5	6	7	8	9
2	0,16	38	32	27	24	21	19	0,22	53	44	38	33	29	26	0,32	77	64	55	48	43	38	0,48	115	96	82	72	64	58	2	0,65	156	130	111	98	87	78	0,97	233	194	166	146	129	116	1,29	310	258	221	194	172	155	1,61	386	322	276	242	215	193	2													
3	0,20	48	40	34	30	27	24	0,27	65	54	46	41	36	32	0,39	94	78	67	59	52	47	0,59	142	118	101	89	79	71	3	0,80	192	160	137	120	107	96	1,19	286	238	204	179	159	143	1,58	379	316	271	237	211	190	1,97	473	394	338	296	263	236	3													
4	0,23	55	46	39	35	31	28	0,31	74	62	53	47	41	37	0,45	108	90	77	68	60	54	0,68	163	136	117	102	91	82	4	1,03	247	206	177	155	137	124	1,82	437	364	312	273	243	218	2,28	547	456	391	342	304	274	4																				
5	0,25	60	50	43	38	33	30	0,35	84	70	60	53	47	42	0,51	122	102	87	77	68	61	0,76	182	152	130	114	101	91	5	1,13	271	226	194	170	151	136	1,68	403	336	288	252	224	202	2,23	535	446	382	335	297	268	2,79	670	558	478	419	372	335	6													
6	0,28	67	56	48	42	37	34	0,38	91	76	65	57	51	46	0,55	132	110	94	83	73	66	0,83	199	166	142	125	111	100	6	1,22	293	244	209	183	163	146	1,81	434	362	310	272	241	217	2,41	578	482	413	362	321	289	3,01	722	602	516	452	401	361	7													
7	0,30	72	60	51	45	40	36	0,41	98	82	70	62	55	49	0,60	144	120	103	90	80	72	0,90	216	180	154	135	120	108	7	1,30	312	260	223	195	173	156	1,94	466	388	333	291	259	233	2,58	619	516	442	387	344	310	3,22	773	644	552	483	429	386	8													
8	0,32	77	64	55	48	43	38	0,44	106	88	75	66	59	53	0,64	154	128	110	96	85	77	0,96	230	192	165	144	128	115	8	1,45	348	290	249	218	193	174	2,17	521	434	372	326	289	260	2,88	691	576	494	432	384	346	3,60	864	720	617	540	480	432	10													
10	0,36	86	72	62	54	48	43	0,49	118	98	84	74	65	59	0,72	173	144	123	108	96	86	1,07	257	214	183	161	143	128	10	1,60	384	320	274	240	213	192	2,38	571	476	408	357	317	286	3,16	758	632	542	474	421	379	3,94	946	788	675	591	525	473	12													
12	0,39	94	78	67	59	52	47	0,54	130	108	93	81	72	65	0,78	187	156	134	117	104	94	1,18	283	236	202	177	157	142	12	1,79	430	358	307	269	239	215	2,66	638	532	456	399	355	319	3,53	847	706	605	530	471	424	4,41	1058	882	756	662	588	529	15													
15	0,44	106	88	75	66	59	53	0,60	144	120	103	90	80	72	0,88	211	176	151	132	117	106	1,31	314	262	225	197	175	157	15	2,07	497	414	355	311	276	248	3,07	737	614	526	461	409	368	4,08	979	816	699	612	544	490	5,09	1222	1018	873	764	679	611	20													
20	0,51	122	102	87	77	68	61	0,70	168	140	120	105	93	84	1,01	242	202	173	152	135	121	1,52	365	304	261	228	203	182	20																																										

**TAB.3-4 CAPACITY HAND LANCES**

TABLE OF DELIVERY IN LITRES / MIN. OF THE CONICAL NOZZLES FOR LEVER LANCE									
note: standard Ø1,5 nozzle									
DIAMETER NOZZLE			Ø 1,0	Ø 1,2	Ø 1,5	Ø 1,75	Ø 2,0	Ø 2,2	Ø 2,5
	5	cone	1,16	1,40	1,90	2,25	2,65	2,90	3,50
		direct jet	1,40	1,70	2,50	3,95	4,7	6,00	7,70
	8	cone	1,40	1,80	2,60	2,80	3,40	3,65	4,45
		direct jet	1,70	2,20	3,40	4,85	6,00	7,60	9,80
	10	cone	1,50	1,96	2,90	3,10	3,90	4,10	5,00
		direct jet	1,90	2,40	3,75	5,40	6,95	8,55	11,0
	15	cone	1,88	2,40	3,40	3,80	4,50	5,00	6,10
		direct jet	2,30	3,00	4,50	6,65	8,30	10,4	13,4
	30	cone	2,60	3,40	4,80	5,40	6,30	7,10	8,70
		direct jet	3,20	4,20	6,40	9,40	11,7	14,7	19,1
	50	cone	3,40	4,40	6,20	6,80	8,10	9,20	11,2
		direct jet	4,10	5,40	8,30	11,8	15,1	19,1	24,6

**TABLE. 3**

TABLE OF DELIVERY IN LITRES / MIN. OF THE CONICAL NOZZLES FOR MITRA SPRAY GUN										
note: standard Ø2,5 nozzle										
DIAMETER NOZZLE			Ø 1,0	Ø 1,2	Ø 1,5	Ø 1,8	Ø 2,0	Ø 2,3	Ø 2,5	Ø 3,0
	15	cone	2,45	3,60	4,60	5,90	6,90	8,10	9,20	11,5
		direct jet	2,50	3,80	5,10	7,30	8,80	10,8	13,0	18,4
	25	cone	3,00	4,25	5,70	7,20	8,10	10,2	11,4	14,4
		direct jet	3,10	4,60	6,50	9,30	11,7	14,1	16,4	24,1
	35	cone	3,40	4,70	6,60	8,50	10,2	12,9	14,0	18,0
		direct jet	3,50	5,40	7,40	10,8	13,4	16,8	19,1	28,2
	40	cone	3,55	5,20	6,90	9,20	10,9	13,7	14,5	18,8
		direct jet	3,65	5,90	7,80	11,7	14,3	17,9	21,0	30,1
	50	cone	4,00	5,60	7,70	10,5	12,5	14,9	16,4	20,9
		direct jet	4,10	6,30	8,60	12,7	15,8	19,7	23,0	33,0

**TABLE. 4**

**TAB.5-6 SPRAYING TABLES**

DISTANCE BETWEEN THE ROWS (m)		2	2,5	3	3,5	4	4,5	5	5,5	6	6,5	7	8	9	10
SPEED (Km/hour)		MINUTES/HECTARE													
<b>TABLE 5</b>	2,0	150	120	100	87	75	67	60	55	50	45	43	37	33	30
	2,5	120	96	80	70	60	53	48	44	40	36	34	30	26	24
	3,0	100	80	66	58	50	44	40	36	33	30	28	25	22	20
	3,5	86	69	57	50	43	38	34	31	29	26	24	21	19	17
	4,0	75	60	50	44	37	33	30	27	25	22	21	19	17	15
	4,5	67	53	44	39	33	30	27	24	22	20	19	17	15	13
	5,0	60	48	40	35	30	27	24	22	20	18	17	14	13	12
	5,5	55	44	36	32	27	24	22	20	18	16	15	13	12	11
	6,0	50	40	33	29	25	22	20	18	17	15	14	12	11	10
	6,5	47	37	30	27	23	20	18	17	15	14	13	11	10	9
	7,0	43	34	28	25	21	19	17	16	14	13	12	10	9	9
	8,0	38	30	25	22	19	17	15	14	12	11	10	9	8	8
	9,0	33	27	22	19	17	15	13	12	11	10	9	8	7	7
	10,0	30	24	20	17	15	13	12	11	10	9	8	7	7	6

WORK TIME (Min)		10	15	20	25	30	35	40	45	50	55	60	65	70	80	90
LITRES/HECTARE		LITRES/MINUTE														
<b>TABLE 6</b>	100	10	6,5	5,0	4,0	3,2	2,7	2,5	2,2	2,0	1,6	1,6	1,5	1,5	1,0	0,8
	150	15	10	7,5	6,0	5,0	4,5	4,0	3,5	3,0	2,5	2,5	2,5	2,0	2,0	1,5
	200	20	13	10	8,0	6,5	5,5	5,0	4,5	4,0	3,5	3,5	3,0	3,0	2,5	2,0
	250	25	16	12	10	8,5	7,0	6,0	5,5	5,0	4,5	4,0	4,0	3,5	3,0	3,0
	300	30	20	15	12	10	9,0	8,0	7,0	6,0	5,0	5,0	5,0	4,0	4,0	3,0
	400	40	27	20	16	13	11	10	9,0	8,0	7,0	7,0	6,0	6,0	5,0	4,0
	500	50	33	25	20	17	14	12	11	10	9,0	8,0	8,0	7,0	6,0	6,0
	600	60	40	30	24	20	17	15	13	12	11	10	9,0	9,0	8,0	7,0
	700	70	47	35	28	23	20	17	16	14	13	12	11	10	9,0	8,0
	800	80	53	40	32	27	23	20	18	16	15	13	12	11	10	9,0
	1000	100	67	50	40	33	29	25	22	20	18	17	15	14	12	11
	1200	120	80	60	48	40	35	30	27	24	22	20	18	17	15	13
	1400	140	95	70	55	45	40	35	30	28	25	24	22	20	17	15
	1600	160	106	80	64	53	45	40	35	32	29	27	25	23	20	18
	1800	180	120	90	70	60	50	45	40	36	33	30	28	25	23	20
	2000	200	134	100	80	67	57	50	45	40	36	33	30	29	25	22
	2200	220	150	110	90	70	60	55	50	44	40	37	34	32	27	24
	2500	250	170	125	100	85	70	60	55	50	45	42	39	36	30	28

**TABLE 7 TABLE OF PROGRAMMED MAINTENANCE**

OPERATION	8 h	50 h	300 h	END OF SEASON
Check the level and state of the oil	0			
Check the accumulator pressure		0		
Check the suction (hoses, pipes, unions)		0		
Check and clean the suction and delivery filters	0			
Check the pump fixing feet and screws in general		0		
Check the diaphragm and the oil and change if necessary			X (1)	X (2)
Check the suction/delivery valves			X	X
Check the pump screws and bolts are tight				X
Check and clean the nozzles and the non-drip diaphragm	0			
Check the wear of the nozzles			0	
Check the hydraulic oil level		0		
Check any failures or cracking of the welds, especially on herbicide booms				0
Grease the articulated joints and the wheel hubs		0		
Check the tyre pressure		0		

NOTE: 0 Operation to be carried out by the operator  
X Operation to be carried out by a specialised technician or in an authorised workshop  
(1) First oil change  
(2) Change at the same time a changing the diaphragm

**TABLE 8 PROBLEMS, CAUSES AND SOLUTIONS**

PROBLEMS	CAUSES	SOLUTIONS
The pump won't charge	Air suction	Check the suction system
	Adjustment valve closed (Command group isn't at zero pressure)	Position the lever correctly
	Valves and/or valve seats suction and delivery worn or dirty	Replace or clean ( * )
The pump doesn't reach the set pressure	Valve and/or valve seat adjustment worn	Replace ( * )
	Valves and/or valve seats suction and delivery worn or dirty	Replace or clean ( * )
	Insufficient rpm	Bring speed up to correct rpm always in the field of 350 ÷ 550 rpm.
	The nozzles used are worn or have holes that are too big	Replace
Irregular pressure (with impulses)	Suction blocked	Clean the cartridge of the filter or remove the blockage
	Valves and/or valve seats suction and delivery worn or dirty	Replace or clean ( * )
Excessive vibrations at delivery	Air suction	Check the suction system
	Pressure accumulator discharged or incorrect air pressure	Bring the air pressure back up to the right value (see pump handbook) ( * )
Noisiness and the level of the oil has dropped	Blocked suction	Check the suction system
Water in the oil	Breakage of one or more diaphragms	Replace ( * ) If the replacement isn't done immediately, drain the water out of the pump and introduce clean oil without water (also used) or diesel to stop rust attacking the internal parts
No liquid comes out of the nozzles	Delivery filter dirty Non-drip filters dirty Nozzles blocked	Clean

NOTE: ( \* ) Only specialised technician



**TAB.12A ALLOWED FITTINGS**

2006																		
<b>TAB. 12 a</b>		CAMPO 11 DSP 11				CAMPO 16 DSP 16				CAMPO 22 C DSP 22 C			CAMPO 22 P-S DSP 22 P-S		CAMPO 32 C DSP 32 C		CAMPO 32 P-S DSP 32 P-S	
" "	BP 171	X	X			X	X			X								
" "	BP 235			X				X		X	X		X		X		X	
" "	BP 280			X				X			X		X		X		X	
" "	BP 265										X			X		X		X
" "	BP 305										X			X		X		X
" "	IDS 1400				X				X			X						
" "	IDS 2000								X			X						
" "	AR 160	X	X			X	X			X								
" "	AR 250			X				X			X			X		X		X
" "	BH 160				X				X			X						
					X				X			X						
					X				X			X						
" "	RPV 206	X				X				X								
" "	DPR 206	X	X	X		X	X	X		X	X		X	X	X	X	X	X
" "	RV 250	X	X	X	X	X	X	X	X	X	X	X	X	X	X	X	X	X
" "	ERGO		X				X											
" "	REMO			X				X			X		X	X	X	X	X	X
	NOVA 101-121-126	X				X				X								
	BD Probo 14-16 Mt	X		X	X	X		X	X	X		X						
	BD WORK 12MT		X		X		X		X		X							
	BD WORK 14-15MT		X		X		X		X		X							
	ALA 12 Mt		X	X	X		X	X	X		X	X						
	ALA 14-16 Mt		X	X			X	X			X	X			X	X		
	ALA 18 Mt										X	X			X	X		
	ALA 21 - 24 Mt.												X	X	X	X	X	X
	BIT 16-18 STD										X	X	X	X	X	X	X	X
	BIT 21 CF -SH - 24 SH												X	X	X	X	X	X
	FUCINO 14-16 Mt			X	X			X	X		X	X						
		X			X	X			X	X								
		X	X	X	X	X	X	X	X	X	X	X	X	X	X	X	X	X
	TDM	X			X	X			X	X		X						
	TDI - TDL	X	X	X	X	X	X	X	X	X	X	X	X	X	X	X	X	X
		X	X	X		X	X	X		X	X		X	X	X	X	X	X
		X	X	X	X	X	X	X	X	X	X	X	X	X	X	X	X	X
		X	X	X	X	X	X	X	X	X	X	X	X	X	X	X	X	X
		X	X	X	X	X	X	X	X	X	X	X	X	X	X	X	X	X
		X	X	X	X	X	X	X	X	X	X	X	X	X	X	X	X	X
	8.3.32 6 HOLE	X	X	X	X	X	X	X	X									
	8.3.38 6 HOLE	X	X	X	X	X	X	X	X									
	9.5.36 6 HOLE - 8 HOLE					X	X	X	X	X	X	X						
	9.5.44 6 HOLE - 8 HOLE									X	X	X						
	11.2.48 8 HOLE										X	X	X	X	X	X	X	X
	12.4.46 8 HOLE												X	X	X	X	X	X
	13.6.48 8 HOLE												X	X	X	X	X	X
	16.9.38 8 HOLE												X	X	X	X	X	X
		X	X	X	X	X	X	X	X	X	X	X	X	X	X	X	X	X
		X	X	X	X	X	X	X	X	X	X	X	X	X	X	X	X	X
			X	X	X		X	X	X	X	X	X	X	X	X	X	X	X
			X	X	X		X	X	X	X	X	X	X	X	X	X	X	X
			X	X			X	X			X		X	X	X	X	X	X
		X	X	X	X	X	X	X	X	X	X	X	X	X	X	X	X	X
		X	X	X	X	X	X	X	X	X	X	X	X	X	X	X	X	X
		X	X	X	X	X	X	X	X	X	X	X	X	X	X	X	X	X
		800	1500	1730	1730	900	1200	1850	1850	1500	2150	2150	2610	2610	2610	2610	2800	2800
		2080	2780	3000	3000	2950	3250	3900	3900	4250	4900	4900	5100	5100	6150	6150	6300	6300
		210	260	270	270	260	380	400	400	700	870	870	900	900	1650	1650	1650	1650
		12	12	15	20	12	12	15	20	12	15	20	15	15	15	15	15	15

**TAB.12B ALLOWED FITTINGS**

2006													
<b>TAB. 12 b</b>		CAMPO-DSP 11		CAMPO-DSP 16		CAMPO-DSP 22 C		CAMPO-DSP 22 P-S		CAMPO-DSP 32 C		CAMPO-DSP 32 P-S	
		VENTO		VENTO		VENTO		VENTO		VENTO		VENTO	
	" " BP 235	X		X		X							
	" " BP 280		X		X		X		X		X		X
	" " BP 265		X		X		X		X		X		X
	" " BP 305							X			X		X
	" " AR 250		X		X		X		X		X		X
	" DPR 206	X	X	X	X	X	X						
	" RV 250	X	X	X	X	X	X						
	" REMO	X	X	X	X	X	X	X	X	X	X	X	X
	ALA 12 Mt	X	X	X	X	X	X						
	ALA 14-16 Mt	X	X	X	X	X	X	X	X	X	X	X	X
	ALA 18 Mt					X	X	X	X	X	X	X	X
	ALA 21 - 24 Mt.								X		X		X
	BIT 16-18 STD						X	X	X	X	X	X	X
	BIT 21 CF - SH - 24 SH								X		X		X
	VENTO Ø700	X	X	X	X	X	X	X	X	X	X	X	X
	VENTO Ø820								X		X		X
		X	X	X	X	X	X	X	X	X	X	X	X
	TDI - TDL	X	X	X	X	X	X	X	X	X	X	X	X
		X	X	X	X	X	X	X	X	X	X	X	X
		X	X	X	X	X	X	X	X	X	X	X	X
		X	X	X	X	X	X	X	X	X	X	X	X
		X	X	X	X	X	X	X	X	X	X	X	X
		X	X	X	X	X	X	X	X	X	X	X	X
		X	X	X	X	X	X	X	X	X	X	X	X
	8.3.32 6 HOLE	X	X	X	X								
	8.3.38 6 HOLE	X	X	X	X								
	9.5.36 6 HOLE - 8 HOLE			X	X	X	X						
	9.5.44 6 HOLE - 8 HOLE					X	X						
	11.2.48 8 HOLE							X	X	X	X	X	X
	12.4.46 8 HOLE							X	X	X	X	X	X
	13.6.48 8 HOLE							X	X	X	X	X	X
	16.9.38 8 HOLE							X	X	X	X	X	X
		X	X	X	X	X	X	X	X	X	X	X	X
		X	X	X	X	X	X	X	X	X	X	X	X
		X	X	X	X	X	X	X	X	X	X	X	X
		X	X	X	X	X	X	X	X	X	X	X	X
		X	X	X	X	X	X	X	X	X	X	X	X
		X	X	X	X	X	X	X	X	X	X	X	X
		X	X	X	X	X	X	X	X	X	X	X	X
		1730	1730	1850	1850	2200	2200	2660	2660	2660	2660	2850	2850
		3000	3000	3900	3900	5000	5000	5200	5200	6200	6200	6400	6400
		230	230	360	360	870	870	900	900	1650	1650	1650	1650
		40	40	40	40	40	40	40	40	40	40	40	40

# IL POLIETILENE ROTAZIONALE

## ROTATIONAL MOULDED POLYETHYLENE

La Unigreen SpA produce un'alta percentuale di polverizzatori con cisterna in polietilene rotazionale a media densità, di seguito riportiamo alcune caratteristiche del materiale:

- altissima resistenza agli urti
- superfici interne lisce che ne garantiscono la facilità di pulizia
- spessore uniforme
- resistenza a tutti i prodotti in uso per agricoltura
- facile riparabilità

*Unigreen SpA produces a high percentage of sprayers with tanks of medium-density linear polyethylene made by rotational moulding.*

*Here is a list of some of the characteristics of the material:*

- *high impact resistance*
- *smooth internal surface to guarantee easy cleaning*
- *uniform thickness*
- *resistance to the chemicals used in agriculture*
- *easy to repair*

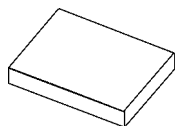
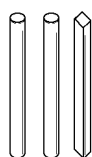
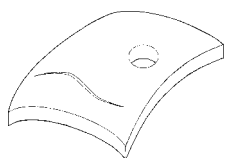
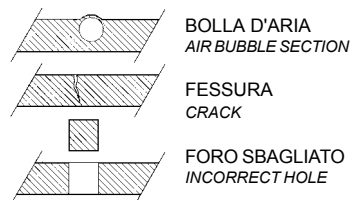

GENERATORE D'ARIA CALDA  
UGELLO OTTIMALE Ø 5+6 mm  
Leister Kombi "TRIAC"



### ISTRUZIONI PER LA RIPARAZIONE DI UNA CISTERNA IN POLIETILENE

- In caso di danneggiamento si consiglia di procedere alla riparazione procurandosi un generatore d'aria calda (reperibile presso qualsiasi idraulico) e chiedendo alla Unigreen il seguente Kit :

Bacchette di polietilene lineare (vari colori)

Blocchetti superficie piana (da cui ricavare tasselli per la riparazione di fori di grandi dimensioni)

### HOW TO REPAIR A POLYETHYLENE TANK

- *In case you have a damaged polyethylene tank and you want to repair it, you need the following:*

- *a hot air generator (obtainable from hardware stores)*

- *the Unigreen basic repair kit containing the following:*

- *Sticks of polyethylene in various colours*

- *Flat blocks of polyethylene to make plugs and stops for larger repairs.*

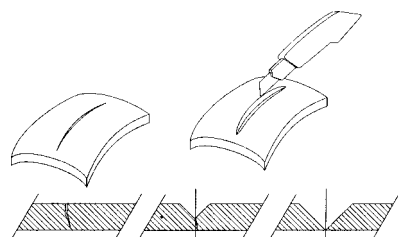

(A)

- Utilizzando un taglierino, allargare in forma conica la zona da riparare per arrivare al 60 ÷ 70% dello spessore.

Le parti devono essere assolutamente pulite.

Nel caso in cui qualche liquido abbia sporcato la zona, se necessario, tagliare per tutto lo spessore.

- *Widen the area to repair in the form of a "V", using a cutter, to 60-70% of the depth of the material.*

*The opening must be absolutely clean, if necessary cut away some of the material all around the damaged area if it has been dirtied by chemical products.*

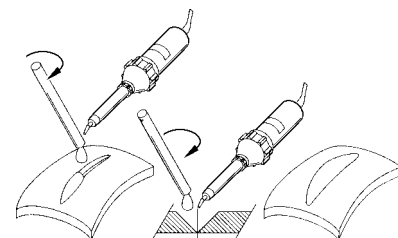

(B)

- Ammorbidire la bacchetta di polietilene utilizzando il generatore d'aria calda.

Scaldando l'area immediatamente circostante la rottura con il generatore, appoggiare la bacchetta sulle parti da riparare e ruotarla fino a fonderle insieme e renderle omogenee.

Prestare attenzione ad ottenere una buona fusione fra la bacchetta ed il pezzo. La linea di saldatura dovrà essere il meno visibile possibile.

- *Heat a stick of polyethylene to soften it and place it in the cut, heating both the stick and the cut to assist the weld.*

*For best results rotate the stick during the operation.*

*Be careful to ensure good fusion and keep the weld smooth and flat to make the repair as least noticeable as possible.*

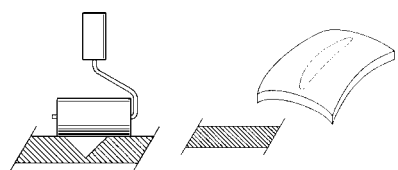

(C)

- Per rendere le superfici più omogenee ci si può aiutare con un rullo metallico. Questo favorisce anche l'eliminazione di eventuali bolle d'aria.

Prima di eseguire la riparazione, si consiglia di fare una prova su un campione di polietilene che trovi

- *To assist in smoothing the repair a metal roller can be used, this will also help in eliminating any air bubbles.*

*Before undertaking any repairs it is advisable to practice on a flat piece of material included in the kit.*

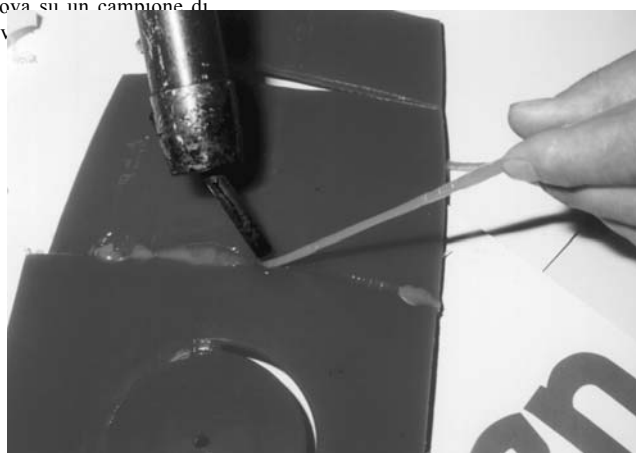

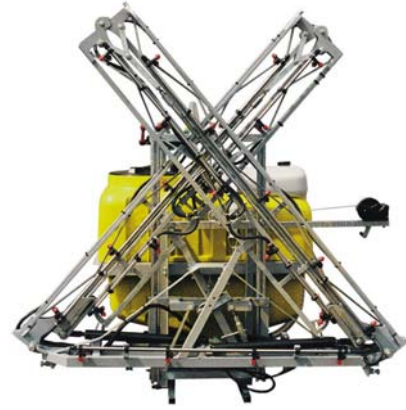

**unigreen**<sup>®</sup>  
S.p.A.  
CROP PROTECTION

via Rinaldi, 105 - Loc. Cavazzoli (Reggio Emilia) - ITALY

Tel. +39 0522 369811

Fax. +39 0522 369898

e-mail: [info@unigreen-spa.com](mailto:info@unigreen-spa.com)  
internet: [www.unigreen-spa.com](http://www.unigreen-spa.com)

member of the **YAMAHA** group



UNACOMA MEMBER

Descriptions, indicative illustrations, UNIGREEN S.P.A. reserves the right to make variations or modifications without prior warning.