

User's Manual

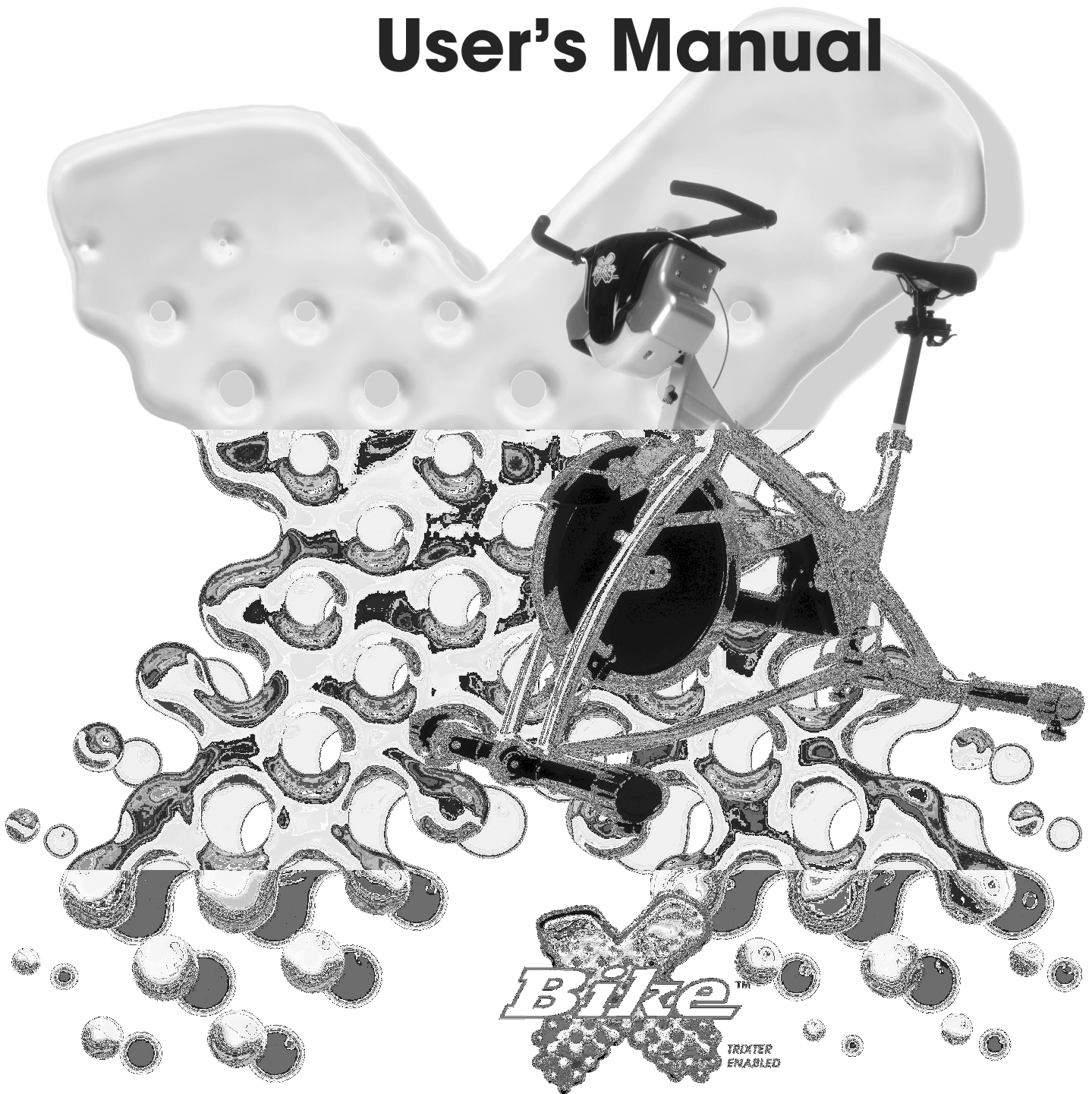

Bike[™]
TRIXTER
ENABLED

Indoor Performance Bike

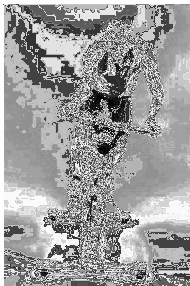
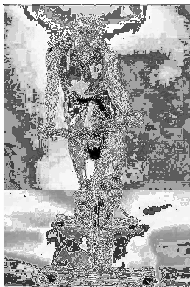

INDOOR PERFORMANCE BIKE



INDOOR CYCLING PROGRAMS

OUTDOOR ATTITUDE BROUGHT INDOORS!

www.trixter.net

TABLE OF CONTENTS

Safety Information	
Page 1	
Introduction.....	Page 3
X-Bike™ Indoor Performance Bike	
X-Biking™ Indoor Cycling Programmes	
Installation and Adjustment.....	Page 4
Setting up the X-Bike™ Indoor Performance Bike	
Assembling the X-Bike™ Indoor Performance Bike	
Adjusting the X-Bike™ Indoor Performance Bike	
Using your X-Bike™ Indoor Performance Bike.....	Page 9
Maintenance Instructions.....	Page 11
Parts – Removal and Replacement.....	Page 15
Equipment and Technical Specifications.....	Page 24
Exploded views and Parts Identification List	Page 25
Product Features.....	Page 28
Warranty Statements and Registration Card.....	Page 32
Index	Page 36

SAFETY INFORMATION



WARNING

TO AVOID DEATH OR SERIOUS PERSONAL INJURY

- **BEFORE beginning any fitness or conditioning program**, consult with your physician or health official. This will establish the proper conditioning or fitness program that is appropriate for your age and physical condition.
- **BE SAFE. Prior to commencing each X-Biking™ Ride answer these questions:**
 - Have you have been ill recently?
 - Have you have felt dizzy recently?
 - Have you have felt breathless recently?
 - Have you have had any chest pain recently?
 - Do you have an injury?
 - Are you pregnant?
 - Is there any reason why you think they should not exercise?
 - Are you over 35 years old and do not exercise regularly?
 - Have you have been told by a health practitioner that they shouldn't exercise?

IF YOU ANSWER “YES” TO ANY OF THE ABOVE QUESTIONS YOU MUST SEEK FURTHER ADVICE AND CLEARANCE FROM A MEDICAL PROFESSIONAL PRIOR TO UNDERTAKING AN X-BIKING™ RIDE.

- **ALWAYS** read the user's manual fully and follow all instructions, which were written to ensure your safety and to protect the cycle.
Note for Club Owners: To ensure the proper use and safety of the X-Bike™ Indoor Performance Cycle, make sure that all users have access to and refer to this manual. The manual should be made available to all users.
- **ALWAYS** operate the X-Bike™ Indoor Bike only on a solid, level surface in a well lit and well ventilated area. Make sure the seat and handlebars are securely fastened before use.
- **NEVER** allow children on the bike or allow children to play unsupervised near the bike. Serious injury could occur due to a child's curiosity or interest in the moving parts of the cycle.
- **ALWAYS** ensure the bike is properly set up for your body type. The X-Bike™ Indoor Bike offers up/down and fore/aft adjustments that are clearly marked to ensure a quick and easy custom fit for each workout. Ensure that the rider compartment is securely tightened before use.
- **ALWAYS** check the cycle before each use.
- **NEVER** use the cycle if it is not completely assembled or is damaged in any way.
- **NEVER** use an X-Bike™ Indoor Bike when ill or in a weakened condition.

- **NEVER** exceed the weight limit for this bike. The weight limit for this bike is 300 pounds. Do not use the X-Bike™ Indoor Performance Bike if your body weight exceeds 300 pounds.
- **ALWAYS** wear proper attire and footwear that fully covers your feet. Long hair should be tied back. Ensure that your laces are tucked into your shoes.
- **ALWAYS** warm up before beginning to exercise or at the start of a workout.
- **ALWAYS** use care when getting on and off the X-Bike Indoor Performance Bike. Always wait until the pedals are completely stopped before removing your feet from the pedals or dismounting. Do not stand or climb on the handlebars.
- **ALWAYS** ride or allow the X-Bike™ Indoor Performance Bike to be ridden only under the supervision of a qualified X-Biking Instructor.
- **ALWAYS** keep hands away from moving parts and always ensure that hands are never placed in a position where there is no rubber handlebar grip.
- **NEVER** overexert yourself or work to exhaustion. If you feel faint, dizzy, short of breath, or if you have chest or other pains, **STOP IMMEDIATELY!** Consult your physician before you continue.
- **ALWAYS** ensure that you have a water bottle with at least 300ml beverage and wear a towel in the rear pocket of your riding top to absorb sweat from your body and the handlebars.
- **NEVER** ride the X-Bike™ Indoor Performance Bike in a standing position at high revolutions per minute (RPM).
- **ALWAYS** maintain your pelvis over the centre line of the X-Bike™ Indoor Performance Bike.
- **NEVER** adjust the resistance of the flywheel and the resistance of the X-Bars™ Handlebar System when standing.
- **NEVER** use accessory attachments that are not recommended by the manufacturer – such attachments might cause injury or damage to the bike and will affect the warranty of the Bike.
- Please also note as a gesture of courtesy to the next user and to maintain the high quality of the X-Bike™ Indoor Cycle, please ensure that it is wiped down after each use.
- If any issues arise affecting the performance of the X-Bike™ Performance Bike, please inform the X-Biking™ Instructor immediately and ensure that wear parts are checked regularly.
- **THIS SAFETY INFORMATION AND USER'S MANUAL GENERALLY DO NOT REPLACE THE NEED TO BE ALERT AND TO USE YOUR COMMON SENSE WHEN USING THE X-BIKE™ INDOOR PERFORMANCE BIKE!**

INTRODUCTION

X-Bike™ Indoor Performance Bike

Congratulations on purchasing your Trixter Enabled X-Bike™ Indoor Performance Bike, one of the most revolutionary cycles available to the fitness market. The X-Bike™ Indoor Cycle will offer you an unrivalled whole body workout by introducing real bike upper-body movements. It has been designed to simulate the real physiological demands experienced throughout the body when cycling...an exercise often mimicked yet never equalled. Climbing out-of-the-saddle, accelerating, and recovering are dynamic total-body actions for everyone riding bicycles outdoors. Climbing steep hills and sprinting involve significant upper body and core muscle recruitment to control the lower-body and the movement of bicycle beneath the rider. The X-Bike™ Indoor Cycle, featuring the X-Bars™ Handlebar System, provides an effective and realistic means of accessing this unique level of fitness. Welcome to the X-Biking™ Indoor Cycling revolution!

X-Biking™ Indoor Cycling Programs

Trixter's visionary X-Biking™ Group Cycling Programmes are ideal for people of all ages, abilities, and fitness levels. Workouts are designed by experienced cycling coaches and elite athletes to maximize the exercise benefits of the X-Bike™ Indoor Cycle. It's the only total-body cardiovascular group exercise workout based on a vibrant, engaging, and real outdoor sport - mountain biking! During the immersive, *fun-fit* classes, you ride with a certified X-Biking™ Instructor to the sound of custom beats over a variety of simulated trails. Techniques like "pumping" up a climb, banking the bars side-to-side to swoop through turns, and even coasting on the X-Bike's unique freewheeling platform provide essential and natural muscular conditioning to dramatically enhance the rider's experience.

Before You Begin

Prior to leaving the manufacturing facility, your X-Bike™ Indoor Cycle was thoroughly inspected and tested for proper operation. To minimize shipping damage, careful attention was given to making the bike ready for shipment.

Dimensions of the X-Bike		
	Inch/lb	mm/kg
Length	47.5	1205
Width	28.5	720
Height	41.5	1050
Weight	143	65

Your X-Bike™ Indoor Mountain Bike will have arrived in 1 carton. Upon arrival, fully inspect the carton for damage. Point out any damage to the delivery person and have the delivery person record the damage on the delivery paperwork. Contact the Customer Service Department to report any damage (See details at the back of this Manual). Please follow these detailed instructions and you will find that your new X-Bike™ Indoor Mountain Bike can be unpacked and assembled with ease.

INSTALLATION & ADJUSTMENT

SETTING UP THE X-BIKE™ Indoor Performance Cycle



WARNING

NOTE THAT THE SAFETY INFORMATION ON PAGES 1 & 2 SHOULD BE FULLY READ AND UNDERSTOOD PRIOR TO ASSEMBLING THE BIKE

A. Remove the bike and components from the shipping carton

1. With assistance, move the box to the desired location in a well-lit and well - ventilated area. Ensure that the carton is standing upright and remove the strapping material. Ensure that you allocate sufficient floor space for the safe operation of the X-Bike after it has been assembled.
2. Pull the cardboard edge along the top of the box and carefully remove and dispose of the staples. Remove the boxes of contents enclosed with the frame.
3. Open each box and ensure that you have the following parts necessary to assemble your X-Bike™ Indoor Cycle:
 - **X-Bike™ Indoor Cycle Frame including Seat Post and Handlebar Assembly comprising Gripshift System and Hand Grips.**
 - **Separate Box with X-Bars™ Handlebar System Head Unit.**
 - **Separate box with front base leg including feet.**
 - **Separate box with rear base leg including feet.**
 - **Separate package with bottom X-Bar Cover (if this has been left off the assembly).**
 - **Separate package with Seat including Seat Slider Rail**
 - **Separate Box with the following**
 - **Head stock adaptor**
 - **Bag with Head stock adaptor bolts**
 - **Quick Release for seat slider**
 - **Bolts, Nuts and Washers for legs (4sets)**
 - **Handlebar clamp including bolts**
 - **Pedals x 1L & 1R**
 - **Bar Ends x 1L & 1R**
 - **Square rubber gator for Frame head tube**
 - **Separate package with the User's manual**

B. Assembling the Bike

All references to the right or left side and to the front or back are made as if you were sitting on the exercise bike ready for use. For example, the chain guard is on the right side of the bike and the flywheel is at the front.

1. You will need the following tools and materials to assemble the X-Bike™ Indoor Performance Bike.
 - Box knife
 - 13mm, 15mm (Pedal Spanner) and 17mm spanners
 - 4mm, 5mm and 6mm (Long) Hex Head Wrenches
 - Can of PTFE (PolyTetraFlouroEthylene) spray.
2. With the help of an assistant, lift the bike frame out of the carton and remove all protective packaging.
3. Fit the legs onto the frame ensuring that the leg with the wheels is fitted to the front and the leg without wheels is fitted to the back. Make sure that the wheels are facing towards the front and that the feet are facing downwards. Insert the M10 bolts provided facing downwards ensuring that you have a washer above and below the leg. Fit the M10 Nut and tighten securely.

Note: If you are having difficulties threading the nut onto the bolt, with assistance prop up the base leg and the frame on wooden blocks to gain easier access to the nut underneath.
4. Adjust the 4 leveller feet to ensure that each corner is fully supported on the floor. Once adjusted, lock the position by tightening the lock wing nut inside the leveller feet.



5. Slide the seat post into the seat tube at the rear of the frame and tighten the adjustable quick release knob until you are ready to set the height position. Slide the seat assembly onto the seat post and fit the quick release handle provided from the bottom upwards. Fit the thumbscrew at the top of the quick release bolt to secure until you are ready to set the fore/aft position.

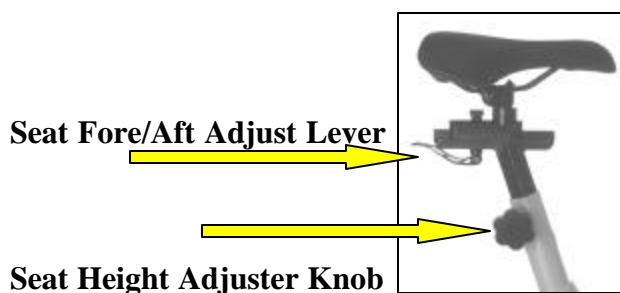

6. To fit the X-Bars™ Handlebar System Head unit, you must first fit the adaptor. This will give access to the main X-Bars frame internally. The adaptor should be fitted so that the head post is facing downwards and towards the rear of the assembly.

Insert the 4 x M8 bolts provided through the base plate of the X-Bars into the adaptor from front towards the rear, and ensure that a washer is fitted on both the nut and bolt ends.

Tighten securely. Fit the bottom cover using the 2 x M4 Hex head screws provided.

7. Before inserting the X-Bars system into the Frame Head tube, place the square rubber gator on the top on the head tube. The X-Bars System assembly is inserted through the rubber gator and into the head tube with the head of the assembly facing towards the front of the bike. Tighten the adjustable quick release knob until you are ready to set the head height position.

Note the orientation of the Handlebar and Bar Ends.

Height Adjuster Knob

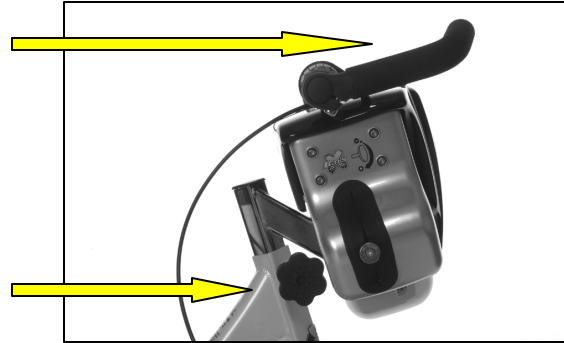

8. Loosen the Handlebar clamp on top of the X-Bars Handlebar System Head Unit to gain access for the handlebar fitment. Place the handlebars into the clamp so that the bar ends are facing towards the front of the bike and the Grip-shift™ is on the right hand side of the bike. Place the marked clamp area of the handlebars centrally in the clamp to ensure to provide maximum grip from the clamp. Refit the clamp and tighten the bolts diagonally to ensure there is an even pressure applied to all four bolts. Just before the clamp takes pressure, adjust the orientation of the bars so that the exit route of the Grip-shift™ has approximately 5mm (1/4”) clearance with the top of the Cover. Tighten securely.

Note orientation of handlebar and position of Grip-shift™

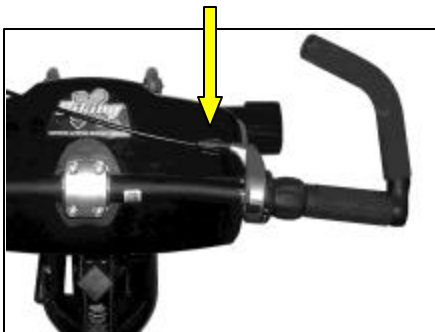

9. Fit the pedals, which are marked as if you are seated on the bike, “R” for right and “L” for left. Carefully thread the right pedal in the crank with your fingers – do not cross thread the pedal in the crank arm. Use a size 15 wrench tool to tighten the pedal. Repeat the step for the left pedal. Do not over-tighten.

Note: The left pedal is reverse-threaded.

10. Using the PTFE spray, direct the nozzle into the wear pad material and apply generously to ensure the pads are well lubricated.
11. Use a soft clean cloth to wipe off dust that may have accumulated during shipping.
12. The X-Bike™ Indoor Cycle is now ready to set up for use.

Adjusting the Bike

Seat Adjustment

1. Rotate the pedals so that one of the pedals is in the upward position.
2. Place your foot in the toe clip of the pedal closest to the floor and mount the bike. Ensure that the ball of your foot is over the centre of the pedal. Your leg should be slightly bent at the knee as shown in the picture below.



3. If your leg is too straight or your foot cannot touch the pedal, you will need to lower the seat. If your leg is bent too much, you will need to raise the seat.
4. To adjust, dismount the bike and release the quick release knob for the seat height adjustment. Once loosened you may slide the seat post up or down as necessary. When the seat is in the desired position, reapply the quick release knob to lock the position. Note the final position mark on the seat stem for future use.
5. Adjusting the fore or aft allows for better fit. To adjust, dismount the bike and release the quick release lever under the seat and slide the seat forward or backward as desired. Re-apply the quick release lever to lock. Note the final position mark on the seat stem for future use.

Adjusting the Flywheel Resistance

The X-Bike™ Indoor Performance Bike should arrive with the resistance system set up on the handlebars already, and may only require minor adjustment after the handlebar assembly has been fitted onto the X-Bars™ System Head Unit. Minor adjustment can be achieved by turning the adjuster wheel at the cable exit on the Grip-shift™ either clockwise or counter-clockwise depending on whether it needs to be increased or decreased.

If the resistance needs more adjustment than is available in the minor adjustment block, it can be set up as follows:

1. Turn the minor adjuster wheel on the Grip-shift™ fully counter-clockwise so that there will be sufficient cable in the minor adjustment block for future regular checks

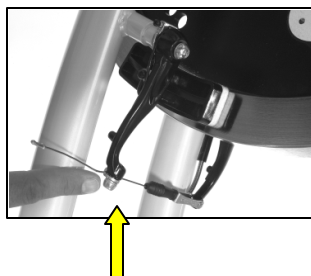
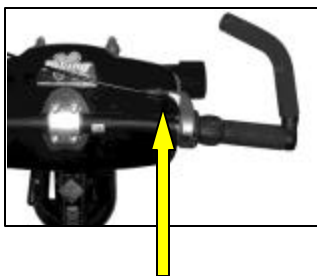

Minor Cable Adjuster

Cable Release Bolt

2. Using a 6mm Hex key, loosen the bolt at the bottom of the V-Brake to release the cable for adjustment.
3. Turn the Grip-shift™ fully clockwise to the minimum resistance setting – position 1. Using one hand, compress the 2 pads of the V-Brake to just make contact with the flywheel. Pull the excess cable until it is tight in the cable clamp. Retighten the bolt to secure the cable.
4. The resistance is set, when the minimum setting is free from contact with the flywheel and position 2 just begins to make slight contact. Minor adjustment can be achieved by screwing the minor adjustment wheel where the cable exits from the Grip-shift™.

Handlebar (Bar Height) Adjustment

1. If you own a road or mountain bike, this position can be taken from your chosen set up. Place a straight edge ruler on top of your bikes saddle and extend it over the handlebar, making sure that the ruler is level or parallel with the ground. Measure the distance from the bottom edge of the ruler to the top of the handlebar and replicate this measurement on the X-Bike™ Indoor Cycle.
2. To adjust, dismount the bike and release the quick release knob on the head tube for the handlebar adjustment. Raise or lower the X-Bar™ System headstock until the required measurement has been achieved. Reapply the quick release knob to lock. Note the final position mark on the handlebar stem for future use.
3. If you do not own a bike and are setting the height up for the first time it is suggested to set the handlebars at the same height as the seat for a datum and then try different heights to get the arrangement most suitable for you.

Pedal Strap Adjustment

1. Place the ball of each foot on the pedal and in the toe clip such that the ball of the foot is centred over the pedal spindle (centre of the pedal)
2. Rotate one foot to within arms reach and pull up on the toe clip strap. Repeat for the other foot.
3. Keep your knees over your foot as you pedal.

USING YOUR X-BIKE™ INDOOR PERFORMANCE BIKE

	<p style="text-align: center;">WARNING</p> <p>SAFETY FIRST – PLEASE REFER TO THE SAFETY INFORMATION ON PAGES 1 & 2 OF THIS MANUAL. THESE GUIDELINES ARE DIRECTED TO YOU AS THE OWNER OF THIS EXERCISE EQUIPMENT AND YOU SHOULD INSIST THAT ALL USERS FOLLOW THE SAME GUIDELINES. YOU SHOULD MAKE THIS MANUAL AVAILABLE TO ALL USERS.</p>
---	---

General Exercise Guidelines

You should only undertake an exercise program using an X-Bike™ Indoor Cycle, under the supervision of a qualified X-Biking™ Instructor. Trixter, Its Distributors and Sales Agents do not accept responsibility for any injury, which may occur whilst riding unsupervised and without proper instruction.

Pedalling

1. Obtain a complete physical examination from your medical doctor and ensure to follow the recommended training profiles suitable for your current health status.
2. The speed and duration of your exercise program should always be subject to how you feel. Never permit peer pressure to exceed your personal judgement while exercising.
3. When working out for the first time, start out slowly for a minimum of five minutes. After your muscles have warmed up, gradually increase the pedalling rate and/or resistance to a speed that allows you to attain a comfortable training threshold. If you have access to a heart rate monitoring device, you can set your speed and resistance that allows you to attain your target heart rate zone.

Pumping the X-Bars

1. Once you are confident with the pedalling motion of the X-Bike, set the flywheel resistance to a comfortable setting and get into a standing position on the bike while continuing to pedal at a steady rate. To familiarise yourself with the pumping motion, set the handlebar resistance to minimum by twisting the handlebar resistance knob at the side of the X-Bars™ Handlebar System fully counter-clockwise and begin to “pump” the bars left and right in time with your pedalling rhythm in a similar fashion as if you were riding a bike. This natural cycling movement comes by ensuring that your right arm and left leg go down at the same time and your left arm and right leg go down at the same time.
2. Overweight individuals should be particularly cautious when using the equipment for the first time. Even though such individuals may not have histories of serious physical problems, they may perceive the exercise to be far less intense than it really is, resulting in the possibility of overexertion or injury.
3. Although all equipment manufactured by Trixter has been thoroughly inspected by the manufacturing facility prior to shipment, the purchaser is responsible for proper assembly and installation of the X-Bike indoor performance bike.

Mounting and Dismounting

Once sitting comfortably on the Bike, make sure to tighten each toe strap securely before commencing exercise. Dismount the bike by first loosening each toe clip and then removing your feet from the pedals. Carefully step off the bike.

Your First Workout

Basic Instructions

Once an instructor has helped you to properly adjust the bike to your body size and you are sitting comfortably on the bike, slowly begin pedalling. Allow your hands to rest comfortably on the handlebars.



WARNING

If at any time during your workout you feel any chest pain, experience severe muscular discomfort, feel faint, or are short of breath, STOP EXERCISING IMMEDIATELY. If the condition persists, you should consult your medical doctor immediately.

Pedalling Resistance

Pedalling resistance is controlled by the turning of the Twist-grip™ located on the right side of the handlebar. The minimum resistance setting is located with the Twist-Grip™ turned fully clockwise – increasing to a maximum Resistance when the Twist-Grip™ is turned fully counter-clockwise. It may be adjusted at any time during exercising by turning the Twist-grip™ to the desired resistance setting.

X-Bar™ Handlebar System Resistance

Handlebar resistance is controlled by the knob located at the end of the resistance damper on the right side of the head section. There are seven settings from minimum to maximum. The resistance can be adjusted at any time by twisting the knob anti-clockwise for minimum and clockwise to maximum setting.

* Your instructor will advise you on the correct use of the X-Bars™ System.

MAINTENANCE INSTRUCTIONS

Helpful Hints

The safety level given by the design of X-Bike™ Indoor Performance Bike can only be maintained when the equipment is regularly examined for damage and wear. Inoperable components should be replaced or the equipment should be put out of use until it is repaired. Read all maintenance instructions before beginning work.

All references to the right or left side and to the front or back are made as if you were sitting on the exercise bike ready for use. For example, the chain guard is on the right side of the bike and the flywheel is on the front.

For identification purposes, the serial number of the X-Bike™ Indoor Cycle is located on the front support Leg and the serial number for the X-Bars™ System is located internally on the main base plate, which can be accessed by removing the bottom cover.

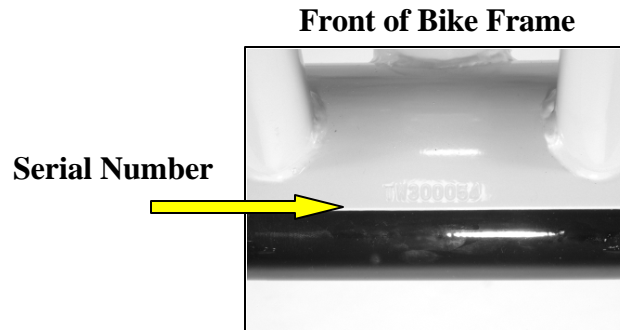

Tool List

The following tools will be needed to carry out service and maintenance:

- Spanners including 10mm, 13mm, 15mm (Pedal Spanner) and 17mm
- Metric Hex Keys (long) set including 2.5, 3, 4, 5, 6, and 8mm.
- Genuine X-Bike BB Lock Ring removal tool.
- Phillips screwdriver
- Bicycle crank arm puller
- Bottom Bearing Cup tool
- Shimano® compatible bottom bracket tool and 1/2 " driver
- Trixter Spring Fitting tool

Preventative Maintenance

Refer to the appropriate Parts Removal and Replacement section on PAGES 19-28 for all disassembly and assembly instructions. If you experience any problems, contact your Matrix Fitness Systems service department (Details found at www.trixter.net).

CHECKLIST OF ROUTINE MAINTENANCE REQUIREMENTS	
Daily	
1.	Wipe Down the X-Bike™ Indoor Cycle
2.	Inspect for loose components and tighten where necessary
Weekly	
1.	Inspect the Wear Pads for excessive wear or dryness
2.	Lubricate the Flywheel
3.	Lubricate the Drive Chain
4.	Clean the X-Bars™ System and X-Bike™ Indoor Cycle
Monthly	
1.	Inspect the Chain Tensioning
2.	Inspect the X-Bars™ System damper performance
3.	Inspect the X-Bars™ System 'Return to Zero' Performance
4.	Inspect the rigidity of the X-Bars™ System to check for looseness in the mechanism.
5.	Inspect the Centre Slider for wear
6.	Inspect the Damper slider for wear
7.	Inspect the seat and handlebars post adjustment for secure height adjustment tightening

Daily

1. Wipe down the X-Bike after each use to remove sweat and moisture. Use soap and water, or a diluted non-abrasive domestic cleaner solution. Rinse to remove detergent residue and then dry off.
2. If the bikes are used frequently in group exercise sessions, inspect for loose components such as pedals or cranks prior to commencing the next class. Tighten up any loose parts.

Weekly

1. Inspect the resistance wear pads for excessive wear or dryness. If necessary lubricate the pads with GT-85 or another PTFE based lubricant. As the pads wear with use, it will be necessary to adjust the resistance cable to compensate. The resistance cable can be adjusted as follows;
 - Turn the minor adjuster wheel on the Grip-shift™ fully clockwise so that there will be sufficient cable in the minor adjustment block for future checks.
 - Using a 6mm hex key, loosen the bolt at the bottom of the V-Brake to release the cable for adjustment.

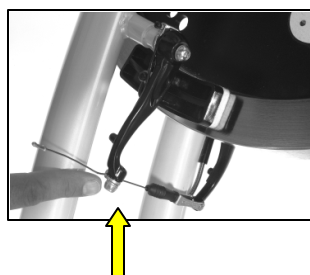
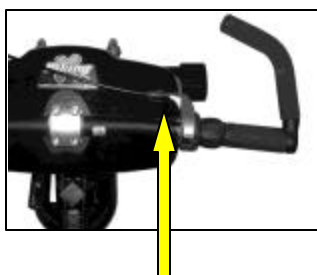

Minor Cable Adjuster

Cable Release Bolt

- Turn the Grip-shift™ fully clockwise to the minimum resistance setting. Using one hand, compress the 2 pads of the V-Brake to just make contact with the flywheel. Pull the excess cable until it is tight in the cable clamp. Retighten the bolt to secure the cable.
 - The resistance is set, when position 1 or minimum setting is free from contact with the flywheel and position 2 just makes contact. Use minor adjustment if required.
 - If the pad thickness is reduced to less than 4mm, they need to be changed. (See Pad Changing instructions in Parts – Removal and Replacement)
2. Wipe down the flywheel with WD-40® or equivalent light oil spray. This lubricant will clean the surface of the flywheel and help prevent rust.
 3. Lubricating the chain – Using a spray can with an extension nozzle; you can gain access to the chain from the front of the chain guard with general light maintenance oil.
 4. To keep the X-Bike looking new, wipe the general bodywork of the X-Bike and X-Bars with a clean damp cloth. Use conventional dish washing detergent but never use abrasive materials to clean the bike. Be certain to wipe off all traces of perspiration when you are finished as it contains salt and other corrosive substances that can damage surfaces and/or leave a white residue.
 5. If you should need assistance or service, contact your service department (See details at www.trixter.net)

Monthly

1. Chain Tensioning

Inspect the chain for tensioning by rotating the crank to drive the flywheel forward. Do this motion in ¼ turns to assess if there is free play between the crank and the flywheel. Tensioning the flywheel is achieved by adjusting the bolts in the front forks of the bike, which set the position on the flywheel axle in the frame. To Tension the chain, undo the axle nuts on either side of the flywheel enough to release the grip and allow the flywheel to move.

Axle Position Markings

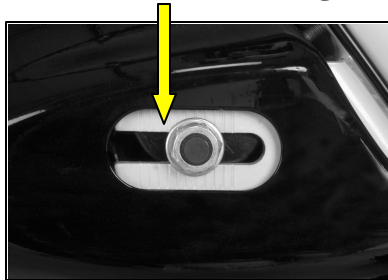

Chain Adjusting Bolts

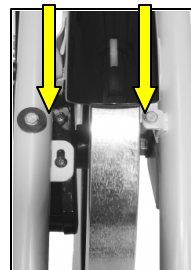

Turn the chain tensioning bolts on both sides of the frame by the same amount to ensure correct alignment. Continue to adjust in small amounts until the chain slack is eliminated and the flywheel can rotate freely without pulling the pedals around with it.

2. X-Bars® Handlebar System Damper Performance

Examine the damper for smoothness and consistency of movement. This is determined by testing the movement in the handlebars firstly in minimum and then in maximum resistance setting.

- a. **Air Cavitations** - At minimum, the movement should be light and smooth without the presence of the sound of air cavitations. This would be a sound you could expect with the presence of tiny air bubbles in the system, which will affect the consistency and quality of resistance. If cavitations are present, the damper should be replaced. See replacing the damper in Parts – removal and replacement section.
- b. **Sticking** - At maximum setting, the handlebars should move from fully left to fully right consistently without any sticking action. Over time, the moving parts can wear and lead to resistance tolerances being affected. If the movement in the handlebars experiences sticking, the damper should be replaced. See replacing the damper in Parts – removal and replacement section.

3. X-Bars® Handlebar System ‘Return to Zero’ Performance

Examine the action of the ‘Return to Zero’ springs on the handlebar system by setting the resistance at maximum. Move the bars to the extreme right and release and then extreme left and release. At this setting the mechanism should return close to centre under its own action. If it is found that the handlebars remain unreasonably fixed to one side or the other, the springs will need to be replaced. See replacing the ‘Return to Zero’ springs in Parts – removal and replacement section.

4. Looseness in the X-Bars® Handlebar Mechanism

- a. **Mechanism Hardware** - Examine the handlebar system assembly for general mechanism looseness. Check all 4 main pivot bolts, the 2 large bolts in the centre of the assembly, and the main damper pin through the end of the damper. If any looseness is present, tighten before reassembly. In the event that any of these bolts have been found to be loose, they should be checked again at the next weekly maintenance routine and if they have re-loosened, please contact your authorised dealer. (Details for your closest dealer found at www.trixter.net)

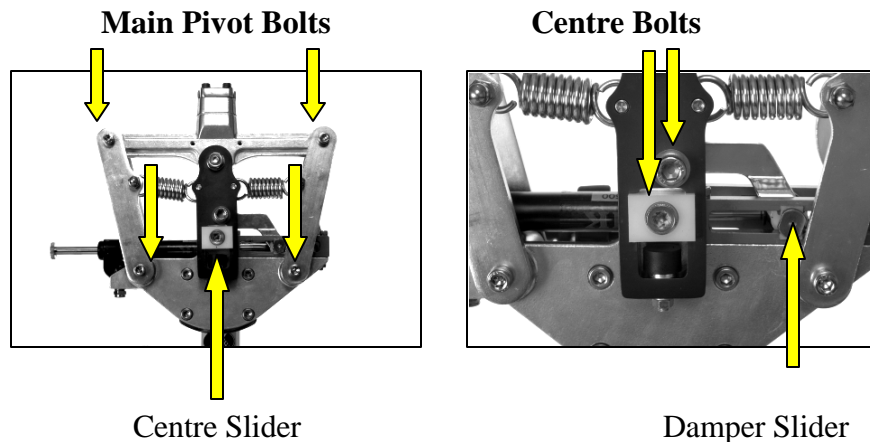

- b. **Slider wear** – There are three sliders in the mechanism, 1 in the centre swinger and the other 2 running in the damper rails. If the clearance between these sliders and the rails in which they run exceeds 1.5mm, they should be replaced.

5. Height Adjustment

Dryness or prolonged use may cause the height and reach adjustments for the bars and seat to become tight. If this is the case, the sliding assembly should be removed from the frame and have a smear of light duty grease applied along the sliding surface before reassembly. Similarly, apply some light grease to the clamping assembly to ensure it does not seize up. Clean off excessive grease before reassembly.

PARTS – REMOVAL AND REPLACEMENT

WARNING:

It is vitally important to keep the X-Bike™ Indoor Cycle properly maintained but if you are unsure about any of the procedures for the removal or replacement of parts, you are recommended to contact your authorised dealer.

NOTE: When carrying out any service or maintenance procedures, it is vital to ensure that ALL hardware has been fully tightened and the assembly is returned to its original assembly state prior to allowing the X-Bike™ Indoor Cycle to be used. If in doubt, contact your authorised dealer.

Replacing the Resistance Pads

1. If the pad thickness is reduced to less than 4mm, they need to be replaced.
2. Using a 6mm hex key, loosen the bolt clamping the resistance cable to release the V-brake mechanism.

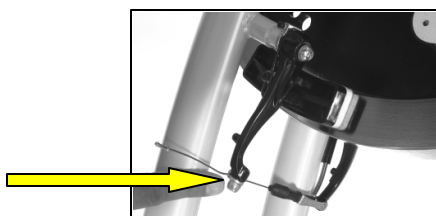

Cable Release Bolt

3. Remove the screw at the back of the pad housing to release. Drop the pad out of the assembly.
4. Fit new pad into the V-Brake assembly on both sides. Refit the screws complete with the spring and washers. Tighten to within 2 full turns from the end.
5. Turn the Grip-shift™ fully clockwise to the minimum resistance setting. Using one hand, compress the 2 pads of the V-Brake to just make contact with the flywheel. Pull the excess cable until it is tight in the cable clamp. Retighten the bolt to secure the cable.
6. The resistance is set, when the minimum setting is free from contact with the flywheel and position 2 just makes contact.

Removing the Chain Guards

Outer Guard

1. Remove the 3 bolts holding the outer guard to the frame. These bolts are 1 at the rear, 1 underneath and 1 between the flywheel and the right hand fork (Left if you look into the bike from the front where it is accessed)

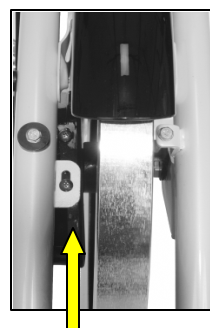
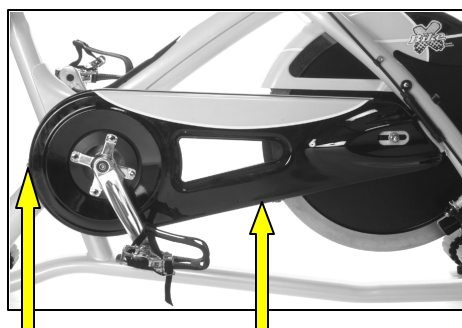

Bolt 1

Bolt 2

Bolt 3

2. Turn the right hand crank arm vertically downwards as this allows the outer guard to be removed more easily.
3. Ease the outer guard away from the inner guard taking care not to damage the protective seals between it and the inner guard. Once free, remove the seal from the bottom of the cover to allow a little more room for removal.
4. Carefully manoeuvre the guard, bottom first away from the frame and orientate it to fit around the crank and the pedal. Once removed, you have full access to the drive train.

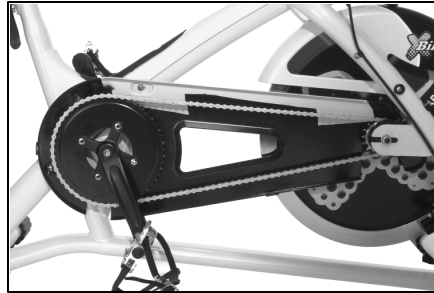

5. Refitting the chain guard is simply to carry out actions 1 to 4 in reverse.

Inner Guard

1. Follow procedure for “removing the pedal crank arms” below.
2. Undo 3 bolts fastening the inner guard to the frame.
3. To refit follow steps 1 and 2 in reverse.

Removing the Flywheel

1. Follow the procedures shown above for removing the chain guard.
2. Loosen the nuts on either side of the flywheel axle enough to allow the flywheel to move freely in the axle slide on the frame.
3. Turn the 2 chain tensioning bolts on the front forks counter-clockwise until they are fully removed from the flywheel bracket.
4. The flywheel axle can then be removed from the slide taking care to support its' weight when it drops out (40 pounds/18.2kg). Care should also be taken not to drop the flywheel onto the frame below, as the paintwork will be damaged.
5. The chain can now be eased off over the front chain sprocket.
6. The flywheel is replaced by following steps 1 to 5 in reverse.
7. To Tension the chain, turn the chain tensioning bolts on both sides of the frame by the same amount to ensure correct alignment. Continue to adjust in small amounts until the chain slack is eliminated and the flywheel can rotate freely without pulling the pedals around with it.

Replacing the Chain

1. Follow the procedures shown above for removing the outer chain guard.
2. Follow the procedures shown above for removing the flywheel.
3. Replace with new chain in a similar fashion and repeat the procedures above in reverse to re-assemble.
4. To Tension the chain, turn the chain tensioning bolts on both sides of the frame by the same amount to ensure correct alignment (Check the alignment by counting the marks on the flywheel bracket on both sides of the frame). Continue to adjust in small amounts

until the chain slack is eliminated and the flywheel can rotate freely without pulling the pedals around with it.

Replacing the Handlebars

1. **NOTE:** Your X-Bike™ Indoor Performance Bike has been fitted with 580mm long handlebars as standard. You must ensure that the new bars to be fitted are within the recommended maximum length of 580mm with a tube wall thickness not less than 3.2mm and are the correct diameter 25.4mm at the clamping section.
2. As you will probably intend to use the existing Grip-shift™ mechanism, you should first remove these parts from the existing assembly.
3. Remove the bar-ends by using a 6mm hex key to loosen the bolt under the clamp.
4. Carefully prise inside the rubber handlebar grips with a small flat head screwdriver and spray some WD-40© or equivalent light oil spray. Ease the grips from either end of the handlebars.
5. Using a 6mm hex key, loosen the 4 bolts from the handlebar clamp on the top of the X-Bars™ Handlebar System to release the grip on the handlebar.
6. Twist the handlebar to expose the bolt holding the Grip-shift™ and using a 2.5mm hex key loosen this bolt. Slide the assembly off the end of the bars.
7. Remove the 4 bolts from the handlebar clamp on the top of the X-Bars™ Handlebar System. Remove the bars from the clamp housing.
8. Fit the new bars ensuring that the orientation of the bar sweep is faced toward the rider as shown. Replace the clamp cap and leave slightly loose until the Grip-shift™ has been refitted and tightened.
9. The Grip-shift™ should be refitted to the right side of the bars ensuring that the cable exit is facing back toward the user with about 5 to 10mm clearance between it and the top of the cover.

Note the orientation of the handlebar and bar ends.

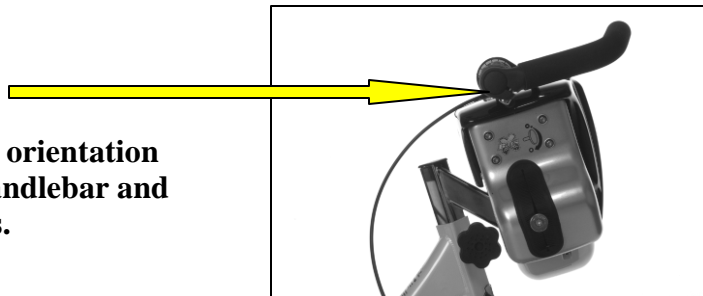

10. Tighten the 4 clamp bolts ensuring a) that the marked clamping area of the bars is central within the clamp and b) the clamp is tightened evenly by all 4 bolts (This can be verified by checking the width of the gap on both sides of the bars – it should be the same).
11. Using conventional hair spray, apply a film of spray to the inside of the grips before fitting onto the ends of the handlebars. The hairspray dries rather quickly and it is recommended to get the grips in place without delay ensuring to leave enough space at the end of the bar for the bar ends. (The reason for the hair spray is that it acts briefly as a lubricant but then dries to create a good grip with the bar).
12. Refit the bar-ends and fully tighten all points before riding the bike.

Replacing the Grip-shift™

1. For removal of the old Grip-shift™, follow procedures 3 to 7 within the section for “Changing the handlebars” above. As the Grip-shift™ is removed from the right side only, you do not have to touch the left side of the handlebars.

2. Using a 6mm hex key, loosen the bolt at the bottom of the V-Brake to release the resistance cable.
3. Pull the resistance cable out of the assembly and all the way through the outer sleeve at the top of the bike (You will have to cut off the protective nipple at the end of the cable using a snips in order pull it through the sleeve).
4. Ensure that you only use recommended replacement parts as other units may not perform as intended and will affect the warranty on the bike.
5. From the new Grip-shift™, feed the cable down through the outer sleeve and in through the V-Brake assembly. (Fit a new protective nipple to the end of the cable by squeezing with pliers).
6. Place the handlebars back into the top clamp and tighten up by following procedures 8 to 12 within the section for “Replacing the Handlebars” above.
7. To set the resistance, turn the Grip-shift™ fully clockwise to the minimum resistance setting. Using one hand, compress the 2 pads of the V-Brake to just make contact with the flywheel. Pull the excess cable until it is tight in the cable clamp. Retighten the bolt to secure the cable.
8. The resistance is set, when the minimum setting is free from contact with the flywheel and position 2 just makes contact.

Removing Pedal Crank Arms

Left Crank Arm

1. Use an 8mm Hex key to remove the pedal crank bolt.
2. Thread a bicycle crank arm puller onto the crank arm shaft.
3. As you tighten the crank arm puller on the shaft, the crank arm will be extracted from the crank arm shaft. Remove the crank arm from the frame.
4. Apply a thin coat of grease on the right bottom bracket shaft and install the right crank arm on the bottom bracket spindle. Align the right crank arm 180° from the right crank arm and push the crank arm onto the crank arm shaft.
5. Apply 1-2 drops of Loctite® 222 on the left crank arm bolt threads. Install the crank arm bolt and tighten to secure the crank arm. Rotate the pedals a few revolutions and then tighten the crank arm bolt again to ensure that the crank arm is tightened to a torque of 22ft/lb (30Nm)

NOTE: Inspect the Pedal crank arm bolts again after 30 hours (approx. one week). If loose, remove the bolts; apply Loctite®222 and reinstall. Retighten the bolts to 22ft/lb (30Nm). Monitor over the following week and if the problem persists, contact your service department (Details for your closest dealer found at www.trixter.net)

Crank Bolt Removal

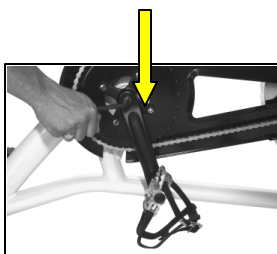

Crank Arm Puller

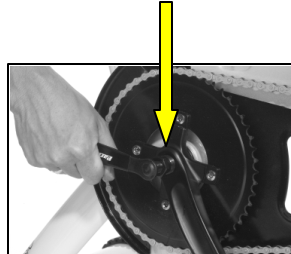

Right Crank Arm

1. Follow procedures for “Removing the Chain Guard” above.
2. Use an 8mm Hex key to remove the pedal crank bolt.
3. Thread a bicycle crank arm puller onto the crank arm shaft.
4. As you tighten the crank arm puller on the shaft, the crank arm will be extracted from the crank arm shaft. Remove the crank arm from the frame.
5. Apply a thin coat of grease on the right bottom bracket shaft and install the right crank arm on the bottom bracket spindle. Align the right crank arm 180° from the left crank arm and push the crank arm onto the crank arm shaft.
6. Apply 1-2 drops of Loctite® 222 on the right crank arm bolt threads. Install the crank arm bolt and tighten to secure the crank arm. Rotate the pedals a few revolutions and then tighten the crank arm bolt again to ensure that the crank arm is tightened to a torque of 22ft/lb (30Nm)
7. Refit the Chain guard by following procedures for “Removing the chain guard” above.
NOTE: Inspect the Pedal crank arm bolts again after 30 hours (approx. one week). If loose, remove the bolts; apply Loctite®222 and reinstall. Retighten the bolts to 22ft/lb (30Nm). Monitor over the following week and if the problem persists, contact your service department (Details for your closest dealer found at www.trixter.net)

Tightening the Bottom Bracket Bearings

1. Follow procedures for “Removing the chain guard” above.
2. Then follow the procedures for removing the pedal crank arms above.
3. Loosen the locking cap on the left side of the bike using the locking cap removal tool.
4. Ensure that the right bearing cup is tight. If necessary, tighten with the bottom bearing cup tool. **Note: the right bearing cup is reverse threaded.**
5. Check the left bearing cup. If the bearing cup is loose, tighten with your fingers. Then use the bottom bracket tool to tighten the bearing cup by rotating the bottom bearing cup tool an additional 10° clockwise.
6. Verify that the bottom bracket spindle is not loose by tugging on the spindle shaft.
7. Use the lock ring removal tool to tighten the lock ring. **Note:** Prevent the left bearing cup from spinning by stabilizing it with the bottom bearing cup tool.
8. Apply a thin coat of grease on the left bottom bracket shaft and install the left crank arm on the bottom bracket shaft. Apply 1-2 drops of Loctite® 222 on the left crank arm bolt threads. Install the crank arm bolt and tighten to secure the crank arm. Rotate the pedals a few revolutions and then tighten the crank arm bolt again to ensure that the crank arm is tightened to a torque of 22ft/lb (30Nm)
9. Apply a thin coat of grease on the right bottom bracket shaft and install the right crank arm on the bottom bracket spindle. Align the right crank arm 180° from the left crank arm and push the crank arm onto the crank arm shaft. Apply 1-2 drops of Loctite® 222 on the left crank arm bolt threads. Install the crank arm bolt and tighten to secure the crank arm. Rotate the pedals a few revolutions and then tighten the crank arm bolt again to ensure that the crank arm is tightened to a torque of 22ft/lb (30Nm)
10. Follow procedures for “Replacing the Chain” and complete the operation by adhering to the section for “Removing the Chain Guard”
NOTE: Inspect the Pedal crank arm bolts again after 30 hours (approx. one week). If loose, remove the bolts; apply Loctite®222 and reinstall. Retighten the bolts to 22ft/lb (30Nm). Monitor over the following week and if the problem persists, contact your service department (Details found at www.trixter.net for your closest dealer)

Removing Pedals

1. Block the crank arm from spinning, and use a bicycle pedal wrench (15mm) on the pedal nut to remove the pedal from the crank arm.



2. Left Pedal: Turn the pedal nut clockwise and remove the pedal from the Pedal crank.
3. Right Pedal: Turn the pedal nut counter-clockwise and remove the pedal from the Pedal crank.
4. Install the new pedals by lightly greasing the threads and reversing steps 1 to 3.

Replacing the Saddle (from the seat post)

1. Using a 6mm hex key, loosen the bolt to release the seat clamp.

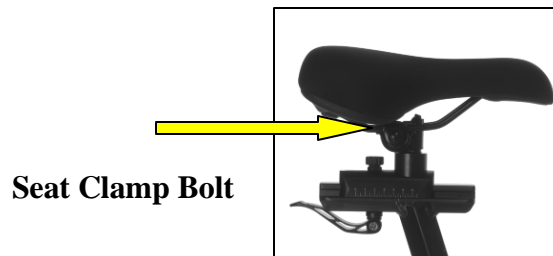

2. Lift the seat off the seat post.
3. Position the new seat on the seat post, level and align the seat as required, and tighten the clamp securely.

Removing the X-Bars covers

Top Cover

1. First remove the handlebar complete with bar-ends and Grip-shift™ from the top clamp (see “replacing the handlebar” section above).

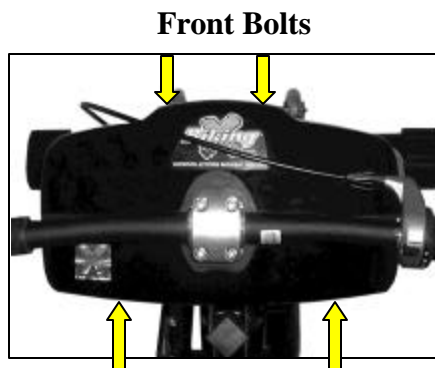

Rear Bolts

2. Undo the Top Covers – at the front and rear by using a 4mm extended hex key. Carefully lift the top cover (front and rear) upwards over the top clamp.
3. To reassemble, carefully position the covers back onto the assembly by easing it downwards over the top clamp until the holes are lined up on the internal assembly.
4. Thread all bolts before tightening any one to ensure that the holes are correctly lined up.
5. Take care to ensure that the seal is correctly secured into the groove on the top bar of the assembly before fastening back onto the assembly.

Side Covers

1. Using a 4mm hex key, remove the 4 bolts holding the side cover onto the assembly to gain access.

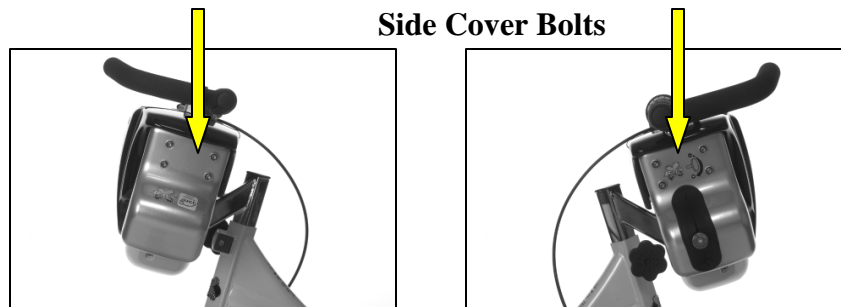

2. When removing the cover from the right side, take care not to damage the brush seal when removing over the damper adjuster.
3. When refitting, thread all 4 bolts before tightening any one to ensure that the holes are correctly lined up.

Bottom Cover

1. Using a 4mm hex key, remove the 2 bolts holding the bottom cover onto the assembly to gain access.

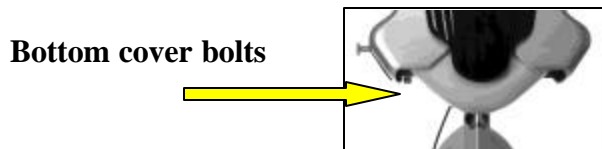

2. Drop the bottom cover downwards from the assembly.
3. Refitting is simply to locate the fixing holes and fit the bolts back in.

Replacing the Damper

1. For this section, only replace with Trixter recommended damper.
2. Remove all covers as directed in the “Removing the X-Bars Covers” section.
3. Using a 13mm wrench remove the nut from the fixed end of the damper.
4. Using 10mm and 13mm wrenches, undo the nut from the damper pin at the moving end of the damper. Remove all components from damper pin noting their position for reassembly.
5. Install the new damper and slide moving eye onto the slider pin. Thread the nut to hold in place.

- 6.** Locate the fixed end of the damper into the bracket on the assembly and fit the nut.
Tighten securely.
- 7.** Tighten the moving end securely.
- 8.** Refit the covers as directed in the covers removal section.

Replacing the “Return to Zero” Springs

1. Remove the top cover as directed in the covers removal section.
2. Using the spring fitting tool, insert into the inner spring loop (see diagram below) and rotate the tool to free the loop from the spring pillar.

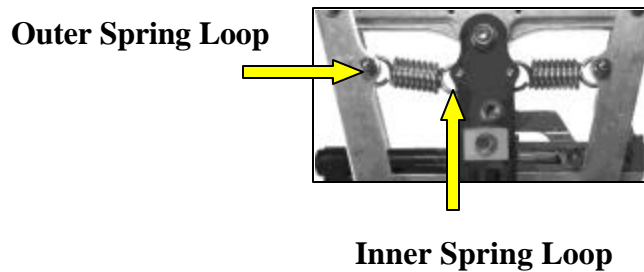

3. Take both old springs out before installing the new ones.
4. Install new spring by fitting the outer spring loop over the spring retaining pillar. Using the spring fitting tool, insert into the inner spring loop and prise it over the outer inner spring pillar.
5. Repeat for the second spring.
6. Apply a film of grease to the 4 loops and move the mechanism right and left a few times to ensure that the grease has made contact all around the loop.
7. Refit the top cover as directed in the cover removal section.

Lubricating the Mechanism

1. Remove top covers as directed in the cover removal section.
2. Using a grease tube with a fine dispensing nozzle, point the nozzle into the following areas;

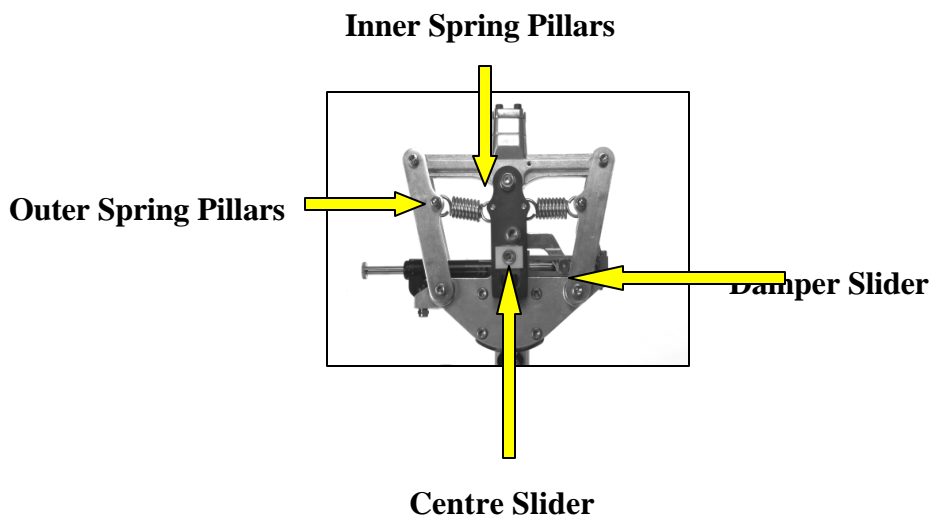

- a. The centre composite slider – apply some grease to each sliding edge on the sides of the slider.
- b. The damper sliders - apply some grease to the top and bottom surfaces of each of the sliders.

Replacing the Centre Slider

1. Remove the top and side covers as directed in the covers removal section.
2. Using an 8mm Hex head, undo the bolt retaining this slider.
3. Remove the bolt taking care not to misplace the plastic washer behind the slider.

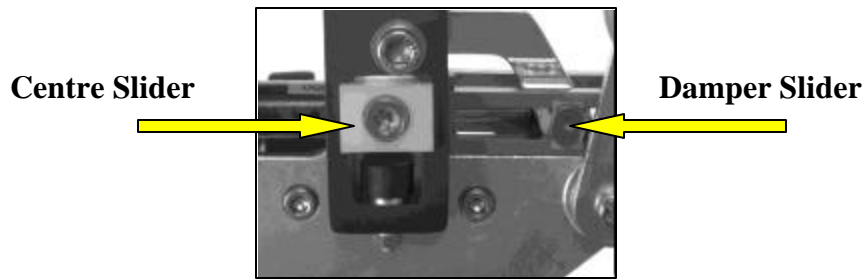

4. Apply Loctite®222 to the bolt and fit through the new slider and reassemble. Tighten securely.
5. Apply some grease to each sliding edge on the sides of the slider.
6. Refit the covers as directed in the cover removal section.

Replacing the Damper Slider

1. Remove the top and side covers as directed in the covers removal section.
2. Using 10mm and 13mm wrenches, undo the nut from the damper pin at the moving end of the damper. Remove all components from damper pin noting their position for reassembly.
3. Replace the 2 damper sliders with the new ones and reassemble in the same order as they were disassembled. Tighten securely.
4. Apply some grease to each sliding edge on the sides of the slider.
5. Refit the covers as directed in the cover removal section.

EQUIPMENT AND TECHNICAL INFORMATION

Please refer to Illustrations on Pages 30 to 32 for more information

X-Bike Frame Specifications	
Frame	Tubular Steel
Pedal drive system	Freewheel drive pedals to Flywheel
Pedals	Either Toe clip or SPD compatible clip less pedals
Flywheel	40 lb (18.2kg)
Flywheel resistance	Multi-position SRAM Grip-shift™
Felt flywheel resistant pads	75mm x 25mm (3" x 1") Felt Pads to provide smooth pedal action
Quick release height adjustment for handlebars	150mm (6") vertical adjustment
Quick release saddle height adjustment	340mm (13.5") saddle height adjustment
Quick release saddle reach adjustment	75mm (3") saddle reach adjustment
Tilt Adjustable saddle	Yes
Metallic and lacquer protected paint system	Yes
Transport wheels on front base leg	Yes
Protective plastic caps on base legs.	Yes
Water bottle cage fittings	Yes
Chain tension adjustment	Yes
Non-slip rubber base for leveller feet	Optional
Elbow pads and arm rests.	Optional
X-Bars Specifications	
Handlebar banking Angle to Bump Stops	12°
Handlebar banking Angle with stops compressed	14°
Maximum Horizontal Throw	102mm
Maximum Vertical Throw	60.8mm
Return to Zero	Yes
RTZ spring resistance	From 300N at centre to 775N at max extremes
X-Bar Damping resistance adjustability	10Kg-f to 50Kg-f
X-Bar Damping range	7 positions
Max allowable force up on handlebars	500N
Max allowable force down on handlebars	1000N
Max Force Fwd/Back on the handlebars	500N
Maximum torque about head tube	170 N-m
General	
Nominal height to centre of handlebars	980mm
Distance from centre of handlebars to Seat Post	580mm nom. (+/- 100mm)
Distance from centre of handlebars to Head Tube	50mm nom.
Pitch of X-Bar movement to horizontal	72 Deg
Adaptor	Bespoke to suit a range of exercise spinner bikes
Base Width	700mm wide base legs to provide excellent stability.
Mechanism Structure	Die Cast Aluminium 356, machined aluminium and Hard Anodised 6061.
Bearings	S45C and SCM430 Steel Chrome Plated
Bushings and Slider Materials	Igus Iglidur G and MC901
Covers	Injection Moulded ABS
Handlebars	HANDLEBARS - 580mm to 680 max straight with 5 deg sweep with wall thickness 3.2mm at centre. Material 2014 Aluminium - Black anodise.
Bar Ends	BAR ENDS - 28.6mm O/D as per SOS Boxer Design. Finish – Black Anodised. Material 2014 Aluminium.
Hand Grips	GRIPS - Length 11.5cm to 12cm. Colour Black. Finish ribbed
Fasteners	Zinc & Clear Passivate

X-Bars Exploded View

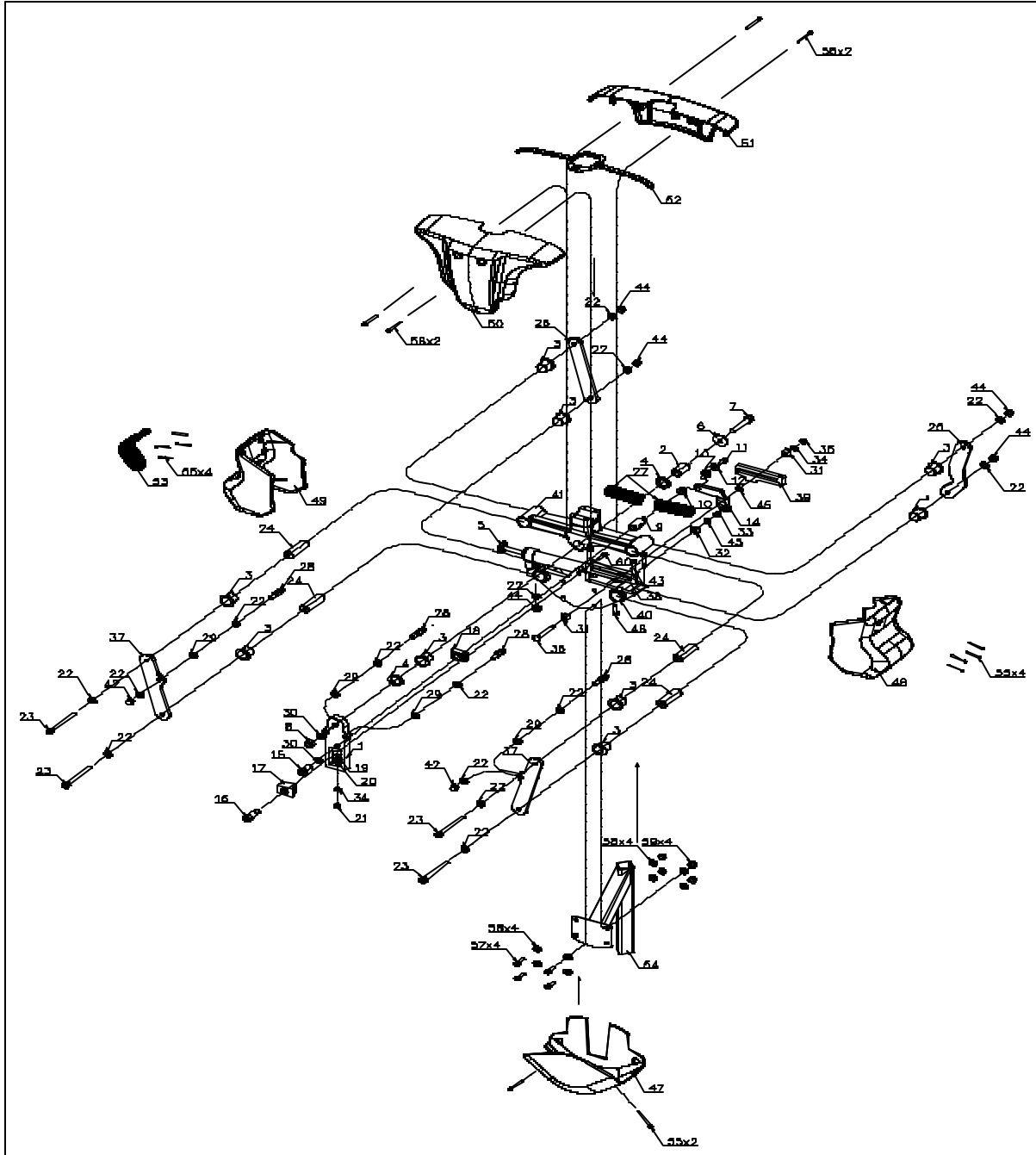

X-Bars Parts Identification Table

ID	PART NUMBER	QTY	PART DESCRIPTION
1	1283-BP6300-001	1	BP63 147.2X46XT14 A6061-T6 ANOD
2	1282-AX1Y00-001	1	AX1Y D20X10.5X34.5L SCM430 CP
3	1282-FB01C0-001	9	FB01C 23X20 L21.5(GFM -2023-21)
4	1285-WS4000-001	2	WS40 D30X20.5X3 UPE
5	1281-ODM500-001	1	NHK ODM 500 DAMPER FOR TRIXTER
6	1285-WS40A0-001	1	WS40A D30X20.5XT2 SPCC CP
7	2110-BB04M1-001	1	BB04 M10X1.5X55 CRMO CP
8	212-4013C1	1	M10X1.5 T9.5 CP(NYLON NUT)
9	1282-AX1Z00-001	1	AX1Z D18X10 S45C CP
10	1282-FB2400-001	1	FB24 D12XD10XL9 (GFM1012-9)
11	211-4616C8	1	BB04AH M6X1.0X16 CP NYLOCK
12	2120-WASHER-009	1	6.2X18XT2 SPCC CP
13	1285-WS4100-001	1	WS41 D18X6.2X3 UPE
14	1286-JP3500-001	1	JP35 A6061-T6 HARD-ANOD.
15	2110-BB04M1-002	1	BB04 M10X1.5X20 CRMO CP W/NYLOCK
16	2110-BB04M1-005	1	BB04 M10X1.5X30/M5X20 CRMO CP W/NYLOCK
17	1283-BP6400-001	1	BP64 W25XH21 MC901
18	1285-WS4300-001	1	WS43 D24Xd12.5X7.5 UPE
19	1282-AX2C00-001	1	AX2C D20XM6XL34 SS41 CP/
20	212-1016C1	1	56A1 6.3X13.5X3.5 FLAT UCP
21	212-4002-1	1	M6 UCP
22	212-1004D7	15	M8 T1.5 FLAT OD16 STL
23	2110-BB04M8-002	4	BB04 M8X1.25X85 CRMO CP
24	1282-AX2B00-001	4	AX2B D20Xd8.1XL58.5 S15C CP
25	1286-JP4300-001	1	JP43 A6061-T6 SIL ANOD(X-BAR)
26	1286-JP3600-001	1	JP36 A6061-T6 SIL ANOD.
27	1281-SPRING-009	2	SPRING D25.4Xd3.66XL68 CP (X-BAR)
28	1282-AX2A00-001	4	AX2A D12XM8X36L S15C CP
29	212-1004E5	4	M8 SPRING WASHER CP
30	212-1007-4	2	M10XT1.2 UCP
31	1283-BP6500-001	2	BP65 W12XH14 MC901
32	1285-WS4400-001	1	WS44 D20Xd8.1X8 UPE
33	1282-FB2700-001	1	FB27 D10Xd8XL8 GSM0810-08
34	212-1058C1	2	6.3/13XT1.2 CP (M6)
35	212-4002D6	1	M6 CP T=6 (NYLON NUT)
36	1282-AX2D00-001	1	AX2D D8XL45.1 SCM430 CP
37	1286-JP3700-001	2	JP37 A6061-T6 ANOD.
38	1283-BP6600-001	1	BP66 110X24XT10 A7075-T6
39	1283-BP7100-001	1	BP71 103X35.5XT10 A7075-T6
40	1283-BP6700-001	1	BP67 A356 POL
41	1286-JP3800-001	1	JP38 A356
42	2124-NUTM80-001	2	M8X1.25 NYLON NUT
43	2110-BB04M6-002	3	BB04 M6X1.0X35 CP W/NYLOCK
44	212-4003D3	5	M8 CP T=8 (NYLON NUT)
45	2120-WASHER-016	2	8.1X15XT0.9 SPCC CP
46	211-4BB04620C5	1	BB04 M6X1.0X20 CRMO CP
47	1276-XBARCV-003	1	X-BAR COVER DOWN ABS P-YELLOW-012C
48	1276-XBARCV-001	1	X-BAR COVER LEFT ABS P-GREY6C
49	1276-XBARCV-002	1	X-BAR COVER RIGHT ABS P-GREY6C
50	1276-XBARCV-F01	1	X-BAR COVER FRONT ABS P-BLACK 3C2X
51	1276-XBARCV-R01	1	X-BAR COVER REAR ABS P-BLACK 3C2X
52	1275-XBARW2-001	1	XBARW2 RUBBER PAD (X-BAR)
53	1275-XBARW1-001	1	XBARW1 RIGHT PAD (X-BAR)
54	1330-XBARHS-001	1	XBARHS H250 EXT99.9 CRMO CP
55	2110-BB1D00-001	10	BB1D M4X0.7X10 STL W/WASHER (TWIST)
56	211-4512B5	4	CP041A M5X0.8X12 STL WO/NYLOCK #3 TOOLS
57	211-4820B3	4	BB04AH M8X1.25X20 STL WO/WS
58	2120-WASHER-017	8	M8 8.2X12XT1.2 STL
59	212-4003D3	4	M8 CP T=8 (NYLON NUT)
60	2115-BB05AH-009	1	BB05AH M5X0.8X13 STL NYLON W/D14 WASHER

X-Bike™ Indoor Performance Bike FEATURES

Structure

X-BIKE™ Indoor Performance Bike

- High strength attractive **tubular and elliptical steel X-bike™ Frame** to provide an incredibly solid X-Bike™, strong enough to handle riders 300lbs (135kg).
- 170 mm forged aluminium alloy **crank arms** with ISIS spline bottom bracket mount with 104/64, 4 bolt chain ring pattern for increased strength and reliability. Crank arms are interchangeable with all popular top quality crank arms except Shimano, so users can install their desired crank arm length.
- 40lb (18.2kg) Balanced Cast Flywheel providing optimum pedalling inertia.
- Heavy gauge **steel chain guard** sufficiently rigid not to crack or bend.
- High strength elliptical tube 700mm wide **base legs** for total stability
- **Stainless Steel hardware** throughout mechanism to prevent corrosion or freezing.
- **Maximum Dimensions (Not working):** Lth 47.5 inches x Wth 28.5 inches x Hgt 39 inches
- **Maximum User Weight Capacity:** 300 lbs
- **Commercial Warranty:** Frame-5 Years, Parts-1 Years, Labor-6 Months, Wear Items-6 Months (Country Dependent). The following parts list includes all wear parts that are protected under the warranty terms for a period of six-months past the date of X-Bike™ Indoor Performance Bike purchase:
 - Damper Unit
 - Damper Access Seal
 - Flywheel Resistance Pads
 - Height Adjustment Knobs
 - Levelling Feet
 - PU Transport

Wheels

- Centre Slider Block
- ‘Return to Zero’ Springs
- ‘Return to Zero’ Spring Pillars
- Handlebar and Bar End Grips
- Resistance Cable (Twist Grip to V-Brake)

All other part and components are protected under the warranty for twelve-months after date of purchase. The X-Bike™ Frame is protected under the warranty for five-years after date purchase.

X-BARS™ Handlebar System

- The die cast **aluminium X-Bars™ System** is lightweight with high strength properties capable of withstanding 125lb-ft (170N-m) torque and 220lb (100kg) vertical load at the end of the handlebars.
- Authentic tamper proof “Trixter Enabled” identification holographic decal placed under the surface clear coat.
- Laser etched chrome plated **square X-Bars™ adaptor** to provide total lock against turning slip.
- X-Bars™ **Bearings and Pivots** constructed from high wear resistant Chrome Plated Hardened Steel S45C and SCM430 materials.
- X-Bars™ **Pivot Bushings and sliders** constructed from maintenance free self lubricating composites paired up with **slide runners** made from high wearing hard anodised aluminium.
- 27” (680mm) straight 2014 aluminium **handlebars** to cater for wide reach upper body workout.

- 4-bolt clamp **handlebar clamp** to provide a very secure bar fitment.
- Boxer **Bar ends**
- Handlebar **Grips** – Hi grip rubber compound.
- **Non-corrosive hardware fitted** throughout mechanism to prevent corrosion.

Performance

- **True Cycle Geometry** provided by the unique trapezoidal movement about a virtual cycling pivot point.
- Optimum **low impact total body workout** for the most efficient combined cross training to be found on an indoor cycle.
- Adjustable Hydraulic **X-Bars™ Damper resistance** to enhance various levels of upper body exercise.
- X-Bars™ **‘Return to Zero’** system providing up to 170lb (780N) pulling force in the mechanism to centralise the bars for regular spinning.
- Boxer **Bar Ends** which provide alternative upper body muscle group workouts and also provide a wrist rest for added rider comfort.
- **High inertia drive system** comprised of the 40lb (18.2kg) flywheel and direct drive gearing to simulate closely the feel of road riding. The sidewall resistance surface of the flywheel is machined to a perfectly even finish. Each wheel is finely balanced through a carefully programmed drilling operation to remove small quantities of distributed weight. The flywheel assembly is completed by fitting a high quality bearing.
- The transmission system is built to pro road bike standards. TH Power Pro 9900st **Bottom Bracket** with ISIS spline drive, hollow, chrome molly steel spindle and sealed cartridge bearings. Standard 68mm bottom bracket width, 110 mm spindle length. The ISIS spline crank arm mounting system is superior to square tapered spindles because it is stronger, less likely to squeak or come loose and makes crank arm removal and installation faster and easier.
- 3” x 1” (75mm x 25mm) felt pads to provide smooth pedal action and evenly distributed resistance.
- KMC S10 **Stainless Steel chain** (1/2 x 1/8” – 116 links) for low maintenance.
- Shimano SF-MX30 1/2 x 1/8, 16T **freewheel** and 52 tooth steel **chain ring** for added life.
- VP D68 aluminium alloy two sided **pedals** with chrome molly axles allowing a choice of SPD clip-less or half-toe clip.

Adjustability

- Fully indexed **Grip-Shift™** providing a very efficient and easy to control adjustment to the flywheel resistance system for lower body elements.
- Fully adjustable **X-Bars™ Damper Resistance System** for upper body elements.
- A five-way, fully adjustable **Rider Compartment** accommodates users of nearly any size. Easily accessible and large one-hand quick release levers to make most the quick and easy adjustments.
- A self-aligning **handlebar stem** adjusts vertically up to 5” (130mm) with laser etched reference numbers on the handlebar stem aid when resetting your position.
- Quick release **Saddle Reach** adjustment up to 3.5” (90mm) via an extremely rigid extruded aluminium track and guide. Laser etched reference numbers on the sliding saddle base help you set your favorite position.
- Quick release **Saddle Height** adjustment laser etched “Indexed” seat positioning. An extra long, self-aligning seat post adjusts 15.75” (400 mm) to accommodate

riders from below 5' (1.5m) to 7' (2.15M) tall. Laser etched reference marks on the seat post make resetting a favorite position easy.

- **Saddle Tilt** of 1.5" (38mm) fore/aft adjustment.
- Four **leveller feet** can be adjusted to compensate for irregular floor surfaces.
- Easily accessible **Chain tension** adjusting bolts to allow simple chain adjustment.

Safety

- The **X-Bars™ Handlebar System** mechanism is enclosed to minimize the possibility of contact with moving parts.
- The Grip-Shift™ position on the handlebars allow the rider to maintain hands and grip in their assumed riding position for comfort, safety and non-interruption to the exercise routine.
- X-Bars™ System **buffered end stop** within the mechanism to provide smooth transition between left and right body movement ensuring no body injury.
- Hi-grip compound **bar end covers** to provide excellent hand grips at the outermost point of the handlebars.
- 28" (700mm) wide base feet for added stability and safety have been fully tilt-table tested.
- Non-slip **rubber cushions** under the leveller feet to ensure no bike movement, even when bike is vigorously worked.
- **Freewheel mechanism** as per standard bicycle ensuring safer cycling with the absence of the inertia of a fixed flywheel.
- **Double-sided pedals** giving the 2 safe options of either toe clips or shoe clips.

Style & Comfort

- Highly attractive and futuristic curved monocoque **X-Bike™ Frame** built from round and elliptical tubular steel.
- 3 Tone, corrosion-resistant, zinc plated and powder coated metallic **paint system** with added protective and cosmetic enhancing clear lacquer coating system for unrivalled presentation and corrosion resistance.
- Integrated **moving covers** system displaying working geometry.
- Stylish **front fender** enhancing X-Bike's™ look and keeping the corporate curved image throughout.
- Contoured highly cushioned **seat** – male and female for maximum comfort
- **Rider controls** are all conveniently located, simple to use and allow for maximum rider comfort and non-interrupted X-Biking™ Ride.

Protection

- **Paint system** – as above with the added benefit of accepting all conventional cleaning materials.
- **Sweat protection** – All covers and general X-Bike features are specifically designed to channel sweat away from sensitive areas.
- **Rubber seals** provided at all points directly within the sweat zone ensuring no sweat ingress to the working mechanisms.
- Easily replaceable **plastic covers** on the handlebars and frame to protect your investment.
- Plastic **kick-plate cover** to protect the frame paintwork when mounting and dismounting the X-Bike™ Indoor Cycle.
- **Front flywheel fender** to channel sweat away from sensitive areas including moving parts and V-Brake system.

- **V-Brake mechanism** is fitted below the flywheel, well out of sweat zone for increased longevity and ease of maintenance.
- **Chain guard** to protect the moving drive parts.
- Full **seam rubber seals** around the chain guard to keep corrosive sweat away from moving parts inside.
- Protective **plastic caps** on 4 corners of base legs.

Service and Maintenance

- **Quick release covers** for accessing dampers and springs when necessary.
- **Chain cover with oiling point** – exceptional ease of maintenance
- Easily accessible **chain tensioning points**.

Mobility & Storage

- Two Large, 3”(75mm) diameter polyurethane **transport wheels** to absorb uneven floor surfaces and also to assist when moving X-Bike™ through door thresholds. Polyurethane won’t scuff or mark floors either.

Additional Features & Options

- Easily accessible water bottle holder
- New integrated water bottle holder holds 1 litre bottles of any shape
- SPD Compatibility
- Elbow pads and arm rests.

THANK YOU FOR PURCHASING AN X-BIKE[®] INDOOR PERFORMANCE BIKE



PLEASE TAKE
MINUTES TO

WARRANTY POLICY (PAGE 39), RECORD AND RETAIN YOUR BIKE DATA (PAGE 40), AND COMPLETE THE WARRANTY REGISTRATION CARD (PAGE 41). THE CARD MUST BE RETURNED TO YOUR NEAREST TRIXTER ENABLED HEADQUARTERS OFFICE WITHIN 14 DAYS OF PURCHASE.

A FEW MORE
READ OUR

X-BIKE INDOOR PERFORMANCE BIKE WARRANTY CARD (COPY FOR THE BUYER)

Frame Serial Number: _____

Date Purchased: _____

Bike Colour: _____

Name of Dealer: _____

X-BIKE INDOOR PERFORMANCE BIKE 6-MONTH WEAR PARTS

The following parts list includes all wear parts that are protected under the warranty terms for a period of six-months past the date of X-Bike[™] Indoor Performance Bike purchase

- Damper Unit
- Damper Access Seal
- Flywheel Resistance Pads
- Centre Slider Block
- 'Return to Zero' Springs
- 'Return to Zero' Spring Pillars
- Height Adjustment Knobs
- Levelling Feet
- PU Transport Wheels
- Handlebar and Bar End Grips
- Resistance Cable (Twist Grip to V-Brake)

All other part and components are protected under the warranty for twelve-months after date of X-Bike[™] Indoor Performance Bike purchase.

The X-Bike[™] Frame is protected under the warranty for five-years after date of X-Bike[™] Indoor Performance Bike purchase.

LIMITED WARRANTY

Trixter North America, Inc. and Trixter Europe Limited (“Trixter”) warrant the frame of each new indoor cycle to be free from defects in material and workmanship for a period of five years from the original date of purchase, as long as the original purchaser owns the cycle. All wear parts are warranted to be free from defects in material and workmanship for the original owner for a period of six months from the original date of purchase. The Wear Parts are listed in the User’s Manual and are available in advance on request. Reasonable wear and tear of the equipment is specifically excluded from any manufacturers warranty obligations. All other original components and all Trixter brand repair parts, replacement parts and accessories, except wear parts, are warranted to be free from defect in material or workmanship for a period of one year from the original date of purchase.

For a period of six months from the original date of purchase, as long as the original purchaser owns the cycle, Trixter will cover the labor cost of the warranty repair procedure. The limit of this element of warranty is covered by the individual procedure for any repair, which includes the limit on repair times based on the times taken by an experienced service engineer with the proper tools and training.

All potential warranty claims must be approved in advance of any work being carried out. Any claim for work already carried out without the appropriate advance approval will be automatically rejected.

TRIXTER MAKES NO OTHER WARRANTIES, EXPRESS OR IMPLIED. ALL IMPLIED WARRANTIES, INCLUDING THE WARRANTIES OF MERCHANTABILITY AND FITNESS FOR A PARTICULAR PURPOSE, ARE LIMITED IN DURATION TO THAT OF THE EXPRESS WARRANTIES STATED ABOVE.

Some states do not allow limitation on how long an implied warranty lasts, so the above limitation may not apply to you.

LIMITED REMEDY

Unless otherwise provided, the sole remedy under the above warranty or any implied warranty is limited to the replacement of defective parts with those of equal or greater value at the sole discretion of Trixter.

IN NO EVENT SHALL TRIXTER BE RESPONSIBLE FOR INCIDENTAL OR CONSEQUENTIAL DAMAGES, WHETHER BASED ON CONTRACT, WARRANTY, NEGLIGENCE, PRODUCT LIABILITY, OR ANY OTHER THEORY, INCLUDING, WITHOUT LIMITATION, PERSONAL INJURY DAMAGES, PROPERTY DAMAGE, OR ECONOMIC LOSSES.

EXCLUSIONS

THE ABOVE WARRANTY, OR ANY IMPLIED WARRANTY, DOES NOT COVER NORMAL WEAR AND TEAR, AND ALL WARRANTIES ARE VOID IF THE INDOOR CYCLING EQUIPMENT IS USED FOR OTHER THAN NORMAL ACTIVITIES INCLUDING BUT NOT LIMITED TO FAILURE TO FOLLOW THE USER’S MANUAL, FAILURE TO FOLLOW THE MAINTENANCE INSTRUCTIONS IN THE USER’S MANUAL, USE UNSUPERVISED BY AN AUTHORISED X-BIKING™ INSTRUCTOR OR THE USE OF NON-GENUINE TRIXTER SPARE PARTS.

Some states do not allow the exclusion or limitation of consequential damages, so the above limitation or exclusion may not apply to you. This warranty gives you specific legal rights, and you may also have other rights, which vary from state to state.

WHAT YOU SHOULD DO

As soon as you experience any problems, note the serial number of the bike, locate your purchase receipt or other proof of date of purchase and your portion of the Warranty Registration Card and contact your Vendor or Distributor.

For up to date information on your distribution network, please visit www.trixter.net.

Or

Locate your purchase receipt or other proof of date of purchase, and then contact the Warranty/Service Department at:

Trixter Europe Ltd (UK)

Trixter House
London Road
Stroud
Gloucestershire
United Kingdom
Tel : +44-1453-840400
Fax : +44-1453-840444
Email : europesales@trixter.net

Trixter North America, Inc

654 Bair Island Rd
Suite 309
Redwood City
CA 94063
USA
Tel : +1-650-367-7525
Fax : +1-650-367-9940
Email : usasales@trixter.net

WARRANTY REGISTRATION CARD

Thank you for purchasing this X-Bike™ Indoor Performance Bike. The Owners' Manual contains important information for proper riding and maintenance of the bike. Before riding, you should read the manual and request that all users read the manual to ensure that the bike is set up and used correctly. You should pay particular attention to the SAFETY INFORMATION on pages 4 and 5 of the Owners Manual to ensure that you or any user are in a healthy physical condition to ride the bike and that the bike is set up correctly for individual use. If you do not fully understand its operation, please contact your dealer. (See www.trixter.net)

Frame Serial Number: _____ Date Purchased: _____

Bike Colour: _____ Dealer Name: _____

Owner's Name: _____ Email Address: _____

Street Address: _____

City: _____ Country: _____

Please return this warranty card to your distributor within 14 days from the date of purchase, which includes the following acknowledgement:

I have read the Owner's Manual. I understand the SAFETY INFORMATION contained in it and that I must post a copy of the X-Biking Safety Notice prominently in the place where the bikes are used. I have read and understand the maintenance procedures set out in the Owner's Manual, that are required to keep the X-Bike™ Performance Bike in a safe operating condition and I understand that the X-Bike™ Limited Warranty is conditional on such maintenance being performed.

Signature: _____ Date : ____/____/____
On behalf of the buyer dd — mm — yy

From time to time we may wish to use the above information for further mailing or other commercial purposes. If you do not wish your details to be used, please tick the box.

To validate the warranty provisions regarding your X-Bike™ Indoor Performance Bike, you MUST fill in and return this Warranty Card to your nearest Trixter office within 14 days of purchase:

Trixter Europe Ltd (UK)
Trixter House,
London Road
Stroud
Gloucestershire GL5 2AY
United Kingdom

Trixter North America, Inc
654 Bair Island Rd
Suite 309
Redwood City
CA 94063
USA

Dear new X-Bike™
Performance Indoor Bike Owner:

This is the backside of the Warranty Registration Card.

**If you have not completed the Warranty Card –
Please DO SO NOW and MAIL IT IMMEDIATELY!**

THANK YOU.

INDEX

Adjustment	10
Assembling the X-Bike Indoor Performance Bike	7
Basic Exercise Instructions	12
Bottom Bracket Bearings	24
Carton Contents	6
Centre slider replacement	28
Chain Guards	20
Chain lubrication	16
Chain replacement	21
Chain Tension Adjustment	16
Cleaning the X-Bike	15
Contents	3
Covers removal	26
Crank arm removal	23
Daily Maintenance	15
Damper performance	17
Damper replacement	26
Damper slider replacement	28
Dismounting the X-Bike	13
Exercise Guidelines	12
Exploded Views	30
Flywheel	20
Flywheel Resistance adjustment	15
Grip-shift replacement	22
Handlebar replacement	21
Pump ing	12
Looseness	18
Maintenance	14
Mechanism lubrication	15
Monthly Maintenance	16
Mounting the X-Bike	13
Pedal Strap Adjustment	11
Pedalling	12
Pedalling resistance	10
Pedals replacement	24
Preventative maintenance	15
Product Features	34
Resistance Pads	19
Return to zero performance	17
Saddle replacement	25
Seat Adjustment	9
Setting up	7
Slider wear	18
Spare Parts	30/32
Springs replacement	27
Technical Specifications	29
Tools	14
Using the X-Bike	12
Weekly Maintenance	15
X-Bar resistance	13

The X-Bike™ Indoor Performance Bike and X-Biking™ Cycling Programs are the only indoor cycling products endorsed by the world governing body for cycling (UCI), active world champion cyclists, elite coaches and the world's leading bicycle manufacturer. Here is what world-class athletes Missy Giove and Scott Beaumont have to say:



Missy Giove
 2-time World Champion
 3-time U.S. National Champion
 “The X-Bike™ Indoor Mountain Bike gives me an ultimate full-body workout while I get my cardio in at the same time. It has helped me get leaner and stronger as a result. It also helps me strengthen joint integrity in my shoulders. It really is superior indoor training”.



Scott Beaumont
 2-time World Champion
 8-time British National Champion
 “I take my training and fitness very seriously and was blown away by the high-quality, total body workout that the X-Biking™ programs give me. It's just awesome to be involved in a project which is set to bring the demands of mountain biking to a new audience”.

To bring the best indoor cycling product into your facilities and to discuss a program tailored to your every need, contact your Trixter dealer or distributor now.

<p>Trixter North America, Inc. 654 Bair Island Road Suite 309 Redwood City, CA 94063 U.S.A. Tel: 1-650-364-7525 Fax: 1-650-367-9940 Email: USAsales@trixter.net</p>	<p>Trixter Europe Ltd (UK) Trixter House London Road Stroud Gloucestershire GL5 2AY United Kingdom Tel: +44 (0)1453-840400 Fax: +44 (0)1453-840444 Europeansales@trixter.net</p>
---	---

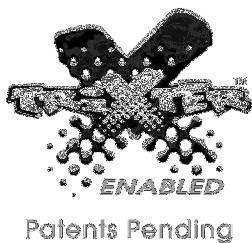

Official Supplier to

