

FULLY AUTOMATIC COFFEE CENTER 5500 IMPORTANT INSTRUCTIONS - SAVE THESE INSTRUCTIONS

Register this product on-line and receive a free trial issue of Cook's Illustrated. Visit <http://registration.delonghi-csservice.com>. Visit www.delonghi.com for a list of service centers near you. (U.S. and Canada only).

MACHINE À CAFÈ AUTOMATIQUE ESAM5500 MODE D'EMPLOI IMPORTANT - CONSERVEZ LES PRESENTES INSTRUCTIONS

Enregistrez ce produit en ligne et recevez un numéro gratuit de Cook's Illustrated. Visitez <http://registration.delonghi-csservice.com>. Visitez www.delonghi.com pour y voir une liste des centres de réparation proches de chez vous. (É.-U. et Canada seulement).

CAFETERA SUPERAUTOMATICA ESAM5500 INSTRUCCIONES IMPORTANTES- REPASE Y GUARDE ESTAS INSTRUCCIONES- LEA ESTE INSTRUCTIVO ANTES DE UTILIZAR EL APARATO

Registre este producto en línea y reciba un ejemplar gratis de Cook's Illustrated. Visite <http://registration.delonghi-csservice.com>. Visite www.delonghi.com para ver la lista de centros de servicios cercanos a usted. (Sólo Estados Unidos y Canada)

MACCHINA PER CAFFÈ SUPERAUTOMATICA ESAM5500 ISTRUZIONI IMPORTANTI- CONSERVARE LE ISTRUZIONI

Registra questo prodotto "on-line" per ricevere una copia omaggio della rivista "Cook's Illustrated". Visita <http://registration.delonghi-csservice.com>. Visita www.delonghi.com per una lista dei centri di servizio a te più vicini. (Solo Stati Uniti e Canada)

ELECTRONIC CHARACTERISTICS:
CARACTÉRISTIQUES ÉLECTRIQUES:
CARACTERISTICAS ELECTRICAS:
CARATTERISTICHE ELETTRICHE:
120V-60HZ 1350W



EN

FR

ES

IT

A

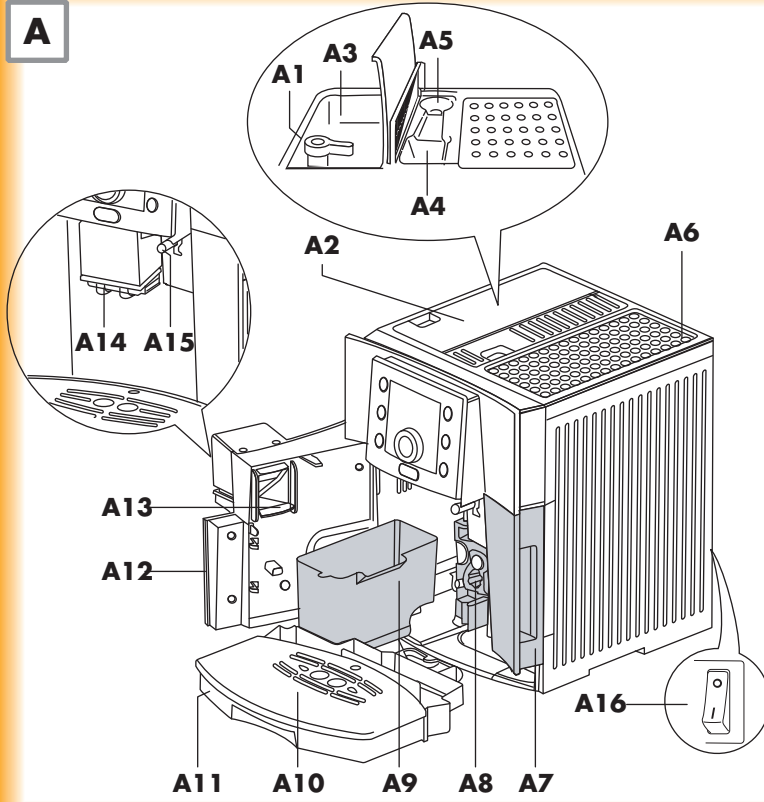

B

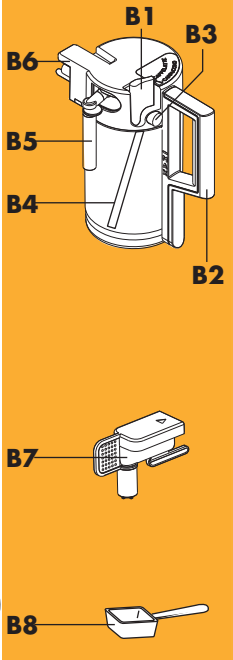

C

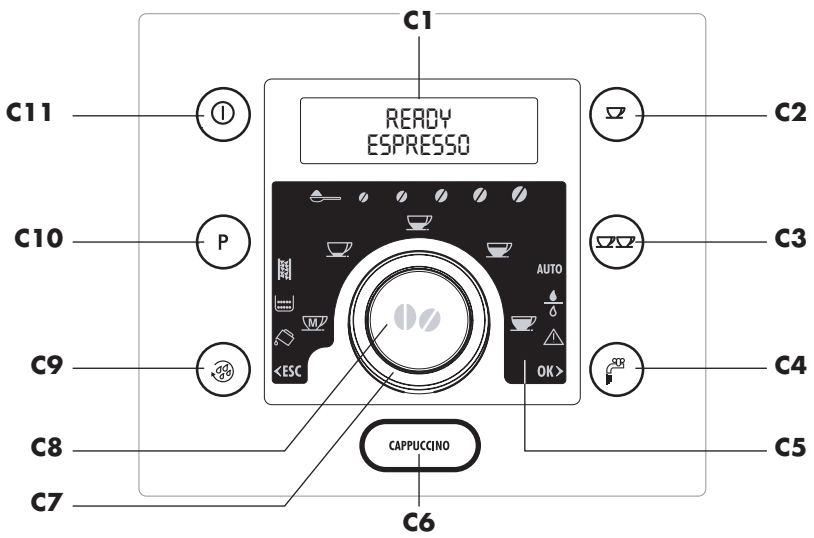

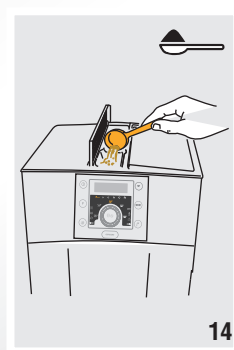
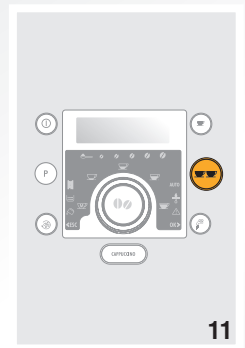
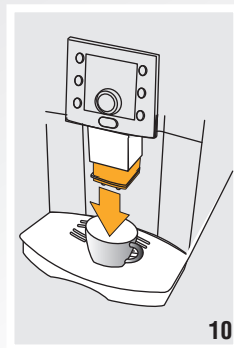
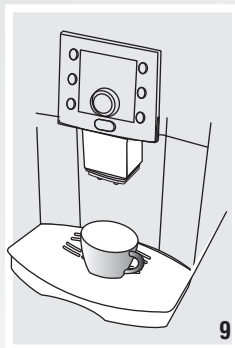
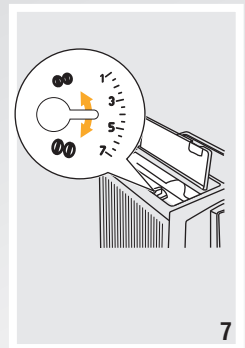
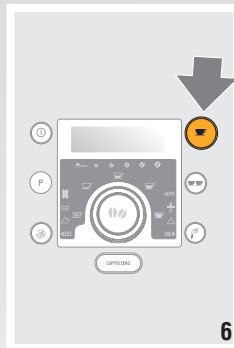
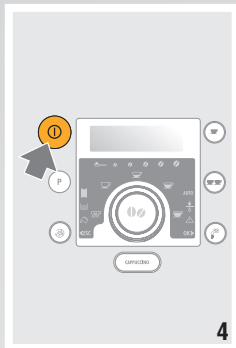
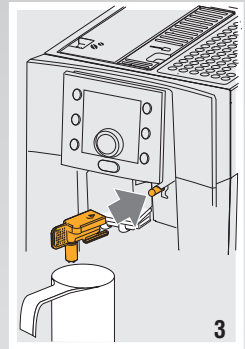
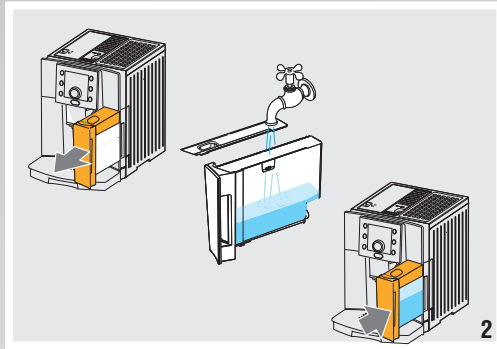
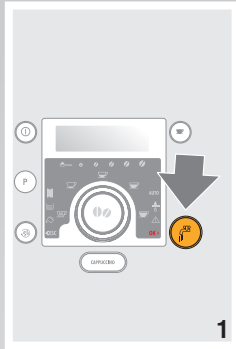

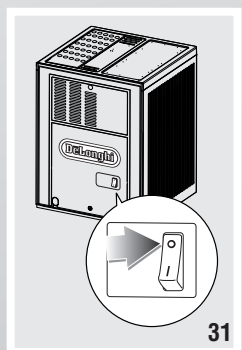
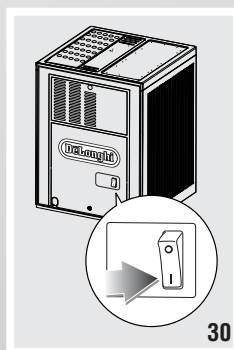
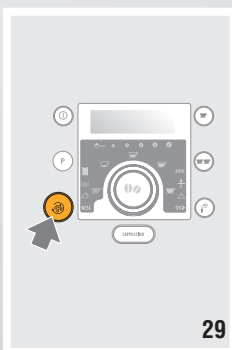
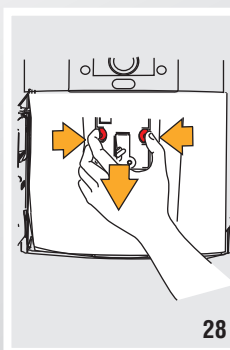
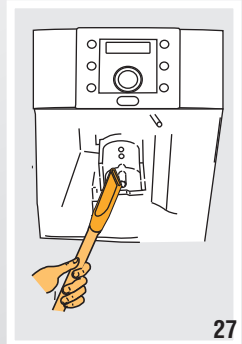
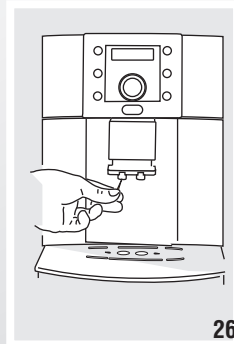
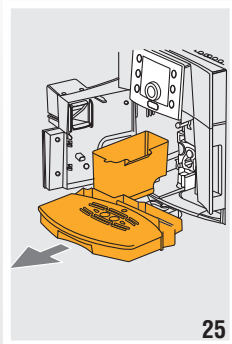
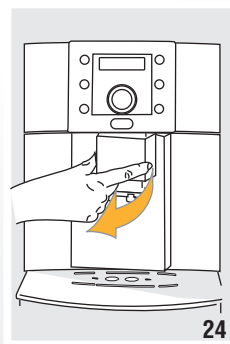
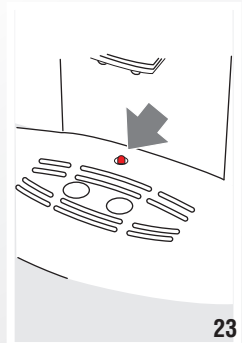
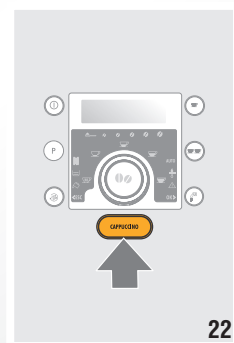
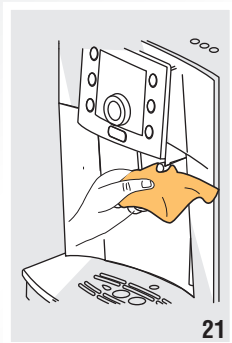
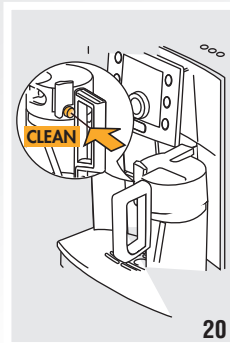
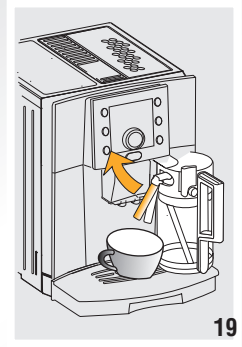
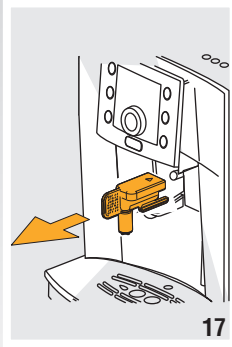

INDEX

IMPORTANT SAFEGUARDS	7
INTRODUCTION	8
Symbols used in these instructions	8
Letters in brackets.....	8
Troubleshooting and repairs	8
DESCRIPTION	9
Description of the appliance.....	9
Description of milk container	9
Description of control panel.....	9
Explanation of indicator lights.....	9
PRELIMINARY CHECKS	10
Controls after transport.....	10
Installing the appliance	10
Connecting the appliance	10
Using the appliance for the first time	10
TURNING THE APPLIANCE ON/OFF 11	
Setting the clock	11
Setting the language	11
Setting automatic start up time.....	11
Descaling	12
Setting the temperature	12
Auto-Off	12
Setting water hardness	12
Resetting factory default values (reset) ...	12
Installing the filter	12
Replacing the filter ("Reset water filter") ..	12
Removing the filter.....	13
Statistics function	13
MAKING COFFEE	13
Selecting the coffee taste	13
Selecting the quantity of coffee in the cup	13
Customizing the "MY COFFEE" quantity ...	13
Preparing coffee using coffee beans.....	14
Making coffee using pre-ground coffee ...	14
Regulating the coffee mill	14
MAKING MILK-BASED DRINKS	15
Filling and attaching the milk container....	15
Making cappuccino	15
Making frothed milk	15
Making caffelatte	15
Making hot milk	15
Programming the quantity of cappuccino.....	16
Cleaning the milk container after use	16
HEATING WATER	16
Preparation.....	16
Changing the quantity	16
CLEANING AND MAINTENANCE	17
Emptying the drip tray.....	17
Cleaning the coffee maker.....	17
Cleaning the water tank.....	17
Cleaning the drip tray.....	17
Cleaning the coffee grounds container.....	17
Cleaning the spouts	18
Cleaning the coffee feed funnel.....	18
Cleaning the inside of the machine	18
Cleaning the infuser	18
Cleaning the milk container.....	18
DESCALING	19
SETTING WATER HARDNESS	19
Measuring water hardness	19
Setting water hardness	20
TECHNICAL SPECIFICATION	20
DISPLAYED MESSAGES	21
TROUBLESHOOTING	23
LIMITED WARRANTY	25

IMPORTANT SAFEGUARDS

When using electrical appliances, basic safety precautions should always be followed, including the following.

- Read all instructions carefully.
- Make sure the voltage of your electrical system corresponds to the voltage shown on the bottom of the machine.
- Do not touch hot surfaces. Use handles or knobs.
- To protect against fire, electrical shock and personal injury, do not immerse cord, plug or appliance in water or other liquid.
- Keep the appliance out of the reach of children and do not leave appliance unattended while in operation.
- Unplug from the outlet when not in use and before cleaning.
- Do not operate with a damaged cord or plug, or after the appliance malfunctions, or has been damaged in any manner. Return the appliance to the nearest authorized service facility for examination, repair or adjustment.
- The use of accessory attachments not recommended by the manufacturer may result in fire, electrical shock, or personal injury.
- Do not use outdoors.
- Make sure the power cord does not hang over the edge of the table or counter-top to avoid getting accidentally caught or entangled.
- Do not place the appliance or its electrical parts on or near electric stoves, cooking surfaces, or gas burners.
- Plug cord into the wall outlet. To disconnect, turn any control to "off", then remove plug from wall outlet.
- Do not use the appliance for other than the intended use. This appliance is to be utilized for domestic use only. The manufacturer declines all responsibility for any damage caused by improper, incorrect, or irresponsible use.

WARNING: To reduce the risk of fire or electric shock, do not remove the cover. No user serviceable parts inside. Repair should be done by authorized service personnel only!

SAVE THESE INSTRUCTIONS

THIS APPLIANCE IS FOR HOUSEHOLD USE ONLY

SHORT CORD INSTRUCTIONS

- A short power cord is provided to reduce risks resulting from becoming entangled in or tripping over a longer cord.
- Longer, detachable power supply cords or extension cords are available and may be used if care is exercised in their use.
- If an extension cord is used, the marked electrical rating should be at least as great as the electrical rating of the appliance. If the appliance is provided with 3- wire, grounding type cord, the extension should be a GROUNDING TYPE 3 - WIRE CORD. The longer cord should be arranged so that it will not drape over the counter-top or table top where it can be pulled on by children or tripped over.
- Your product is equipped with a polarized alternating current line plug (a plug having one blade wider than the other). This plug will fit into the power outlet only one way. This is a safety feature. If you are unable to insert the plug fully into the outlet, try reversing the plug. If the plug should still fail to fit, contact your electrician to replace your obsolete outlet. Do not defeat the safety purpose of the polarized plug.

INTRODUCTION

Thank you for choosing the ESAM 5500 automatic coffee maker.

We hope you enjoy using your new appliance.

Take a few minutes to read these instructions.

This will avoid all risks and damage to the machine.

Symbols used in these instructions

Important warnings are identified by these symbols.

These warnings must absolutely be respected.

Failure to observe the instructions could result in electric shock, serious injury, burns, fire or damage to the appliance.



Danger!

Failure to observe the warning could result in possibly life threatening injury from electric shock.



Important!

Failure to observe the warning could result in injury or damage to the appliance.



Danger of burns!

Failure to observe the warning could result in scalds or burns.



NB:

This symbol identifies important advice or information for the user.

Letters in brackets

The letters in brackets correspond to the legend in the Description of the appliance on page 3.

Troubleshooting and repairs

In the event of problems, first try and resolve them following the information given in the section "Displayed messages" on page 21 and "Troubleshooting" on page 23.

If this does not resolve the problem or you require further information, you should consult the customer service center by calling the number given on the "Customer Service" sheet.

If your country is not among those listed on the sheet, call the number given in the guarantee.

If repairs are required, contact the customer service center only.

The addresses are given in the guarantee certificate provided with the machine.

DESCRIPTION

Description of the appliance

(pag. 3 - **A**)

- A1. Grinding coarseness regulator knob
- A2. Bean container lid
- A3. Container for coffee beans
- A4. Ground coffee feed funnel
- A5. Compartment for measuring scoop
- A6. Cup warmer shelf
- A7. Water tank
- A8. Infuser
- A9. Coffee grounds container
- A10. Cup tray
- A11. Drip tray
- A12. Service door
- A13. Coffee guide
- A14. Coffee spout (adjustable height)
- A15. Hot water and steam nozzle
- A16. Main switch (some models only)

Description of milk container



(pag. 3 - **B**)

- B1. Milk frother slide
- B2. Milk container handle
- B3. CLEAN button
- B4. Milk intake tube
- B5. Frothed milk spout
- B6. Milk frother
- B7. Hot water spout
- B8. Measuring scoop

Description of control panel

(pag. 3 - **C**)

A number of buttons on the panel have a dual function. This is indicated in brackets in the description.

- C1. Display: guides the user in operating the appliance.
- C2.  button: to prepare 1 cup of coffee with the settings displayed
- C3.  button: to prepare 2 cups of coffee with the settings displayed.
- C4.  button: Delivers hot water
(Button is also used as "OK" for MENU selections)
- C5. Indicator lights: indicate the current settings, alarm messages or need for maintenance.
- C6. CAPPUCCINO button to prepare cappuccino or frothed milk for Latte.

- C7. Selection knob: turn clockwise or counterclockwise until the light corresponding to the quantity of coffee comes on

 customized "my coffee"

 espresso coffee

 normal coffee

 long coffee

 extra long coffee

(When you access the MENU: turn to select).

- C8. Aroma selection button  : press until the light corresponding to the strength of coffee you want to make comes on.

 pre-ground coffee

 extra-mild taste

 mild taste

 standard taste

 strong taste

 extra-strong taste

- C9. Rinse button  : performs a brief rinse to heat the infuser.
(Button is also used as "ESC" for MENU selections)

C10. P button to access the menu:

- C11.  button: turns the appliance on and off

Explanation of indicator lights

 Indicates the need to descale the appliance.

 The grounds container is full and must be emptied.

 The water tank is empty and must be filled with fresh water.

AUTO  The Auto-Start function is active.

 The filter is exhausted and must be replaced.

 An alarm is displayed.

OK  Indicates the button to press to confirm the choice in the menu.

<ESC  Indicates the button to press to exit the menu or selected function.

PRELIMINARY CHECKS

Controls after transport

After removing the packaging, make sure the product is complete and undamaged and that all accessories are present.

Do not use the appliance if it is visibly damaged. Contact the Customer Service Center if product seems damaged in any way.

Installing the appliance



Important!

When you install the appliance, you should respect the following safety warnings:

- The appliance gives off heat. Leave a free space of at least 1 inch around the sides and back of the appliance and at least 6 inches at the top, otherwise the heat could be trapped and damage the machine.
- Water penetrating the appliance could cause damage. Do not place the appliance near taps or sinks.
- The appliance could be damaged if the water it contains freezes. Do not install the appliance in a room where the temperature could drop below freezing point.
- Arrange the power cable in such a way that it cannot be damaged by sharp edges or contact with hot surfaces (e.g. electric hot plates).

Connecting the appliance



Important! Check that the mains power supply voltage corresponds to the value indicated on the rating plate on the bottom of the appliance.

Connect the appliance to an properly grounded and correctly installed socket with a minimum current rating of 10A only. If the power socket does not match the plug on the appliance, have the socket replaced with a suitable type by a qualified professional.

Using the appliance for the first time



NB!

- Coffee has been used to factory test the appliance and it is therefore completely normal for there to be traces of coffee in the mill. The machine is, however, guaranteed to be new.
- You should customize water hardness as soon as possible following the instructions in the section "Setting water hardness" on page 19.
- Some models are fitted with a water softener filter which reduces the build up of limescale in the appliance. To install, see the instructions in the section "Installing the filter" on page 12.

1. Plug appliance into electrical outlet.

You must first select the language (the languages scroll through at intervals of about two seconds):

2. When English appears, press the **OK** >  button for three seconds (fig. 1). Once the language has been saved, the message "English Installed" is displayed.

Follow the instructions indicated by the appliance:

3. "FILL TANK!": remove the water tank, fill to the MAX line with fresh water then replace in the appliance (fig. 2).
4. "INSERT WATER SPOUT AND PRESS OK": Check that the hot water spout is inserted on the nozzle and place a container underneath (fig. 3). Press the **OK** >  button (fig. 1). "Please Wait..." is displayed and the appliance begins to run off hot water.

The appliance ends the first start up procedure, then the message "Turning Off, Please Wait..." is displayed and the appliance goes off.

The coffee maker is now ready for normal use.



NB! When using the appliance for the first time, you need to make 4 to 5 cups of coffee and 4 to 5 cappuccinos before the appliance starts to give satisfactory results.

TURNING THE APPLIANCE ON



N.B.! Before turning the appliance on, make sure the main switch is in the I position (fig. 30). Each time the appliance is turned on, it performs an automatic preheat and rinse cycle which cannot be interrupted.

The appliance is ready for use only after completion of this cycle.



Danger of burns! During rinsing, a little hot water is run off from the coffee spouts. Avoid contact with splashes of water.

- To turn the appliance on, press the button (fig. 4). The message "Heating Up... Please Wait" is displayed.

After heating, the message "RINSING" is displayed. While the boiler is heating, the appliance also heats the internal circuits by circulating hot water.

The appliance is at temperature when the message "READY Standard Taste" is displayed.

TURNING THE APPLIANCE OFF

Each time the appliance is turned off, it performs an automatic rinse cycle which cannot be interrupted.



Danger of burns! During rinsing, a little hot water is run off from the coffee spouts. Avoid contact with splashes of water.

To turn the appliance off, press the button (fig. 4). The appliance performs the rinse cycle then goes off.



N.B.! If the appliance is not used for an extended period, place the main switch in the 0 position (fig. 31).

CHANGING THE MENU SETTINGS

Setting the clock

- Press the P button to enter the menu;
- Turn the selection knob until "Adjust Time" is displayed;

- Press the button;
- Turn the selection knob to change the hours;
- Press the button to confirm (or the <ESC button to cancel the operation);
- Turn the selection knob to change the minutes;
- Press the button to confirm (or the <ESC button to cancel the operation);
- Press the <ESC button to exit the menu.

Setting the language

- Press the P button to enter the menu;
- Turn the selection knob until "Set Language" is displayed;
- Press the button;
- Turn the selection knob until the required language is displayed;
- Press the button to confirm (or the <ESC button to cancel the operation);
- Press the <ESC button to exit the menu.

Setting automatic start time

You can set the auto-start time in order to have the appliance automatically turn on (for example in the morning) so you can make coffee immediately.

- Press the P button to enter the menu;
- Turn the selection knob until "Auto-Start" is displayed;
- Press the button;
- Turn the selection knob to change the hours;
- Press the button to confirm (or the <ESC button to cancel the operation);
- Turn the selection knob to change the minutes;
- Press the button to confirm (or the <ESC button to cancel the operation);
- Press the <ESC button to exit the menu.

After confirming the time, the red AUTO light on the display comes on indicating that the function is active.



To deactivate the function, select auto-start from the menu and press OK. Then exit by pressing the <ESC button.

The AUTO icon on the display goes off.







NB! To activate this function, the time must be set.





Descaling

1. Press the P button to enter the menu;
2. Turn the selection knob until "Descaling" is displayed;
3. Press the **OK** >  button;
4. The message "Confirm?" is displayed.
5. Press the **OK** >  button to confirm (or the  < **ESC** button to cancel the operation);
6. Carry out descaling as described in the section "Descaling" on page 19.





Setting the temperature

1. Press the P button to enter the menu;
2. Turn the selection knob until "Set Temperature" is displayed;
3. Press the **OK** >  button;
4. Turn the selection knob until the required temperature (high, medium, low) is displayed;
5. Press the **OK** >  button to confirm (or the  < **ESC** button to cancel the operation);
6. Press the  < **ESC** button to exit the menu.

Auto-Off



1. Press the P button to enter the menu;
2. Turn the selection knob until "Auto-Off" is displayed;
3. Press the **OK** >  button;
4. Turn the selection knob until the required number of hours of operation (1, 2 or 3) is displayed;
5. Press the **OK** >  button to confirm (or the  < **ESC** button to cancel the operation);
6. Press the  < **ESC** button to exit the menu.

Setting water hardness

1. Press the P button to enter the menu;
2. Turn the selection knob until "Water Hardness" is displayed;
3. Press the **OK** >  button;
4. Turn the selection knob until the water hardness measured using the indicator strip is displayed (see paragraph "Measuring water hardness" - page 19);
5. Press the **OK** >  button to confirm (or the  < **ESC** button to cancel the operation);
6. Press the  < **ESC** button to exit the menu.

Resetting factory default values (reset)

This function resets the entire menu with the default values (except the language, which remains as set).

1. Press the P button to enter the menu;
2. Turn the selection knob until "Default Values" is displayed;
3. Press the **OK** >  button;
4. The message "Confirm?" is displayed.
5. Press the **OK** >  button to confirm and exit (or the  < **ESC** button to cancel the operation);

Installing the filter



Certain models are provided with a water softener filter (alternatively it can be purchased separately from an authorized Customer Service Center).

To install the filter, proceed as follows:

1. Insert the filter in the water tank as far as it will go (see figure alongside).





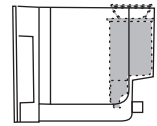

When you install the filter, you must notify the appliance of its presence.

2. Press the P button to enter the menu;
3. Turn the selection knob until "Install Filter" is displayed;
4. Press the **OK** >  button;
5. The message "Confirm?" is displayed.
6. Press the **OK** >  button to confirm (an asterisk appears at the top right of the display);
7. Press the  < **ESC** button to exit the menu.





Replacing the filter ("Reset water filter")

When the red light  comes on, the filter must be replaced:

1. Extract the exhausted filter and replace with a new one;
2. Press the P button to enter the menu;
3. Turn the selection knob until "Reset Water Filter" is displayed;
4. Press the **OK** >  button;
5. The message "Confirm?" is now displayed.
6. Press the **OK** >  button to confirm (or the  < **ESC** button to cancel the operation);
7. Press the  < **ESC** button to exit the menu.

Removing the filter



If you want to use the appliance without a filter, you must remove it and notify the appliance of its removal as follows:

1. Press the P button to enter the menu;
2. Turn the selection knob until "Install Filter" is displayed;
3. Press the OK >  button;
4. The message "Confirm?" is displayed.
5. Press the  <ESC button;
6. When the asterisk has disappeared from the top right of the display, press  <ESC to exit the menu.



Important! If this is not done, the appliance could become clogged with limescale.

Statistics function

1. Press the P button to enter the menu;
2. Turn the selection knob until "Statistics" is displayed;
3. Press the OK >  button;
4. Turn the selection knob to verify:
 - how many coffees have been made;
 - how many cappuccinos have been made;
 - how many times the machine has been descaled;
 - the total number of litres of water run off;
 - how many times the water filter has been replaced.
5. Press the  <ESC button twice to exit the menu.

MAKING COFFEE

Selecting the coffee taste

The appliance is preset to make coffee with a standard taste.

You can also choose one of these tastes:

 Extra-mild taste

 Mild taste

 Standard taste

 Strong taste

 Extra-strong taste

To change the flavor, press the  button (fig. 5) repeatedly until the required taste is displayed.

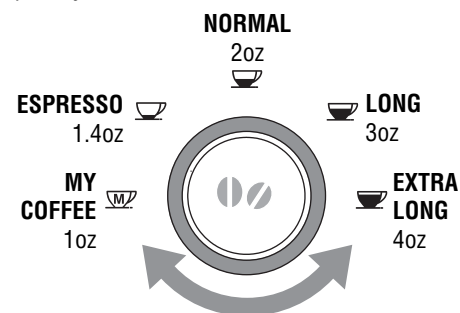

Selecting the quantity of coffee in the cup

To select the quantity of coffee, turn the selection knob until the light corresponding to the required quantity of coffee comes on:



Customizing the "MY COFFEE" quantity

The appliance is factory preset to automatically deliver 1oz.

1. Place a cup under the coffee spouts (fig. 9).
 2. Turn the selection knob (C7) until the  light comes on.
 3. Press and hold the 1 cup button  for at least eight seconds (fig. 6). When the message "1 MY COFFEE Program Quantity" is displayed the button can be released and coffee will be delivered into the cup;
 4. As soon as the coffee in the cup reaches the required level, press the 1 cup button  again. The quantity set has now been programmed.
- The "my coffee" button is only programmable using the 1 coffee button. When "my coffee" setting is being used and the 2 coffee button is pressed, a double shot of the programmed quantity will be delivered.

Preparing coffee using coffee beans



Important! Do not use caramelized or candied coffee beans as they could stick to the coffee mill and make it unusable.

1. Fill the container (A3) with coffee beans (fig. 8).
2. Place under the coffee spouts:
 - 1 cup, if you want to make 1 coffee (fig. 9);
 - 2 cups, if you want 2 coffees.
3. Lower the spouts as near as possible to the cup. This makes a creamier coffee (fig. 10).
4. Press the corresponding coffee button (1 cup ☞ or 2 cups ☞☞) (fig. 6 and 11).
5. Preparation begins. A progress bar appears on the display and gradually advances as the procedure progresses (fig. 12).

Once the coffee has been made, the appliance is ready to use again.



NB!

- While the machine is making coffee, run-off can be interrupted at any moment by pressing one of the coffee buttons (☞ or ☞☞).
- As soon as run-off is finished, to increase the quantity of coffee in the cup, just hold down one of the coffee buttons (☞ or ☞☞) until the required amount is reached (this must be done within three seconds after completion of run-off).
- If the coffee drips out, or runs out too fast with little crema or too cold, read the tips in the "Troubleshooting" section on page 23.

Making coffee using pre-ground coffee



NB! If you use pre-ground coffee, you can only make one cup of coffee at a time.

1. Press the ☞☞ button repeatedly (fig. 13) until "READY PRE-GROUND" is displayed.



Important!

- Never add pre-ground coffee when the machine is off or it could spread through the inside of the machine and dirty it. This could damage the appliance.
- Never use more than one level measure or it could dirty the inside of the machine or block the funnel.



2. Put one level measure of pre-ground coffee into the funnel (fig. 14).
3. Place a cup under the coffee spouts.
4. Press the 1 cup ☞ coffee button (fig. 6).

Regulating the coffee mill

The coffee mill is preset in the factory to prepare coffee correctly and should not require regulating initially.

However, if after making the first few coffees you find that run-off is either too fast or too slow (drips), this can be corrected by adjusting the grinding coarseness regulator knob (fig. 7).

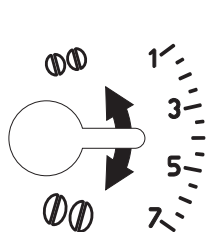

For slower run-off and creamier coffee, turn one click towards the "1" (finer ground coffee).

For faster run-off (without dripping, turn one click towards the "7" (coarser ground coffee).

These adjustments will only be evident after at least 2 cups of coffee have been run off.



NB! The grinding coarseness regulator must only be turned when the coffee mill is in operation (After coffee button has been pressed and you hear the grinder working.) Only adjust grinder one setting at a time.

MAKING MILK-BASED DRINKS

Filling and attaching the milk container

1. Turn the lid of the milk container clockwise until it becomes noticeably difficult to turn, then remove the lid.
2. Fill the milk container with a sufficient quantity of milk, not exceeding the MAX level marked on the handle (fig. 15).

i **NB!** You should ideally use skimmed or 2% milk at refrigerator temperature (about 41°F).

3. Make sure the milk intake tube (B4) is correctly inserted in the bottom of the milk container lid (fig. 16).
4. Replace the milk container lid and turn counterclockwise as far as it will go.
5. Remove the hot water spout from the nozzle (fig. 17).
6. Attach the container to the nozzle, pushing as far as it will go (fig. 18).
7. Place a sufficiently large cup under the coffee spouts (A14) and the frothed milk spout (fig. 19). If necessary, move the frothed milk spout slightly outwards (B5 - fig. 19).

Making cappuccino

1. Fill the milk container (B) with milk and attach it as described in the section "Filling and attaching the milk container".
2. Position the milk frother slide (B1) between the words CAPPUCCINO and CAFFELATTE printed on the milk container lid cover. The quantity of froth can be adjusted by moving the slide towards the word CAFFELATTE for a denser froth. Moving it towards the word CAPPUCCINO obtains a less dense froth.

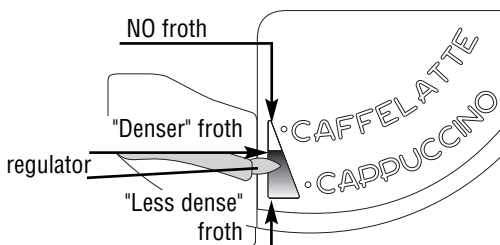

3. Press the cappuccino button (fig. 22). The message "Cappuccino" is displayed. (After a few seconds, frothed milk runs out of the milk spout into the cup below. Run off of milk stops automatically and run off of coffee begins.)

i **N.B.!** If you want to stop preparation, press the CAPPUCCINO button twice. Pressing it once stops frothed milk run-off, pressing it twice stops coffee run-off.

Making frothed milk

1. Fill the container (B) with milk and attach it as described in the section "Filling and attaching the milk container".
2. Set the frothed milk regulator (B1) to the quantity of froth required.
3. Press the CAPPUCCINO button (fig. 22) twice. The message "Milk Frothing" is displayed.

i **NB!** If you want to stop preparation of frothed milk, press the CAPPUCCINO button once.

Making caffelatte

1. Fill the container (B) with milk and attach it as described in the section "Filling and attaching the milk container".
2. Set the frothed milk slide (B1) to CAFFELATTE.
3. Press the CAPPUCCINO button (fig. 22). The message "Cappuccino" is displayed.

i **NB!** If you want to stop preparation of caffelatte, press the CAPPUCCINO button twice.

Making hot milk

1. Fill the container (B) with milk and attach it as described in the section "Filling and attaching the milk container".
2. Set the frothed milk slide (B1) to CAFFELATTE.
3. Press the CAPPUCCINO button (fig. 22) twice. The message "Milk Frothing" is displayed.

i **NB!** If you want to stop preparation of hot milk, press the CAPPUCCINO button once.

Programming the quantity of coffee and milk in the cup for cappuccino or frothed milk

The appliance is factory preset to automatically deliver 2.4oz of frothed milk and 2.7oz of coffee.

To modify these quantities, proceed as follows:

1. Place a cup under the coffee spouts and the frothed milk spout (fig. 19).
2. Press and hold the CAPPUCCINO button for at least eight seconds (fig. 22). The message "Milk for Cappuccino Program Quantity" is displayed.
3. Release the button. The appliance starts running off milk.
4. Once the required quantity of milk has been run off into the cup, press the CAPPUCCINO button again.
5. After a few seconds, the appliance starts running off coffee into the cup and the message "Coffee for Cappuccino Program Quantity" is displayed.
6. Once the required quantity of coffee has been run off into the cup, press the CAPPUCCINO button again. Coffee run-off stops and "READY" is displayed.

The machine is now reprogrammed with the new quantities.

Cleaning the milk container after use

Clean the internal tubes of the milk container each time you use it to avoid the build-up of milk residues or blockages.



Important! Danger of burns When cleaning the internal tubes of the milk container, a little hot water leaks out of the frothed milk tube (B5). Avoid contact with splashes of water.

1. Place a cup or other container under the frothed milk spout (B5 - fig. 19);
2. Press the "CLEAN" button (B3 - fig. 20) and hold it down for at least eight seconds. The message "Cleaning" is displayed.
3. Remove the milk container and clean the nozzle with a sponge (fig. 21).

HEATING WATER

Preparation



Important! Danger of burns. Never leave the machine unsupervised while running off hot water. As shown below, stop run-off of hot water when the cup is full. The hot water spout becomes hot while water is running off and must be handled by the handle only.

1. Make sure the hot water spout (B7) is attached correctly (fig. 3).
2. Place a container under the spout (as close as possible to avoid splashes).
3. Press the  button (fig. 1). The message "Hot Water..." is displayed. Water runs out of the spout.





NB! Stop the flow of hot water by pressing the  button.



Important: You should not run off hot water for more than two minutes at a time.

Changing the quantity

The appliance is factory preset to automatically deliver 8.5oz. To modify these quantities, proceed as follows:

1. Position a container under the spouts.
2. Press and hold the  button down for 8 seconds. The message "Hot Water Program Quantity" is displayed.
- When the hot water in the cup reaches the required level, press the  button again.

The machine is now reprogrammed with the new quantity.

CLEANING AND MAINTENANCE



Danger of electric shock! Before performing any cleaning operations, the machine must be turned off and disconnected from the mains power supply.

Never immerse the coffee maker in water.



Important! Danger of burns. Allow the machine to cool down before cleaning.



Important!

- Do not use solvents, abrasive detergents or alcohol to clean the coffee maker.
- None of the components can be washed in a dishwasher.
- Do not use metal objects to remove encrustations or coffee deposits as they could scratch metal or plastic surfaces.

Emptying the drip tray



Important! If the drip tray (A11) is not emptied regularly, the water could overflow from the edge and seep inside or around the machine. This could damage the machine, the surface it rests on or the surrounding area.

The drip tray has a water level indicator in the form of a red float which rises up as the level of water in the drip tray rises.

Empty the drip tray before the red float protrudes from the tray (fig. 23).

To remove the tray:

1. Open the service door (fig. 24);
2. Remove the drip tray and the grounds container (Fig. 25);
3. Empty the drip tray and grounds container (A9);
4. Insert the drip tray complete with grounds container (A9);
5. Close the service door.

Cleaning the coffee maker

The following parts of the machine must be cleaned regularly:

- water tank (A7),
- drip tray (A11),
- coffee grounds container (A9),
- coffee spouts (A14) and hot water nozzle (A15),
- pre-ground coffee feed funnel (A4),
- inside the machine, accessible after opening the service door (A12),
- infuser (A8),
- milk container (B)

Cleaning the water tank

1. Clean the water tank (A7) regularly (about once a month) with a damp cloth and a little mild dish detergent.
2. Clean to remove all soap residues, then rinse the water tank thoroughly.

Cleaning the drip tray

- Clean the drip tray (A11) each time you empty it using a damp cloth and a little mild dish detergent.

Cleaning the coffee grounds container

1. Clean the grounds container (A9) each time you empty it using a damp cloth and a little mild dish detergent.
2. Try removing the toughest coffee encrustations with a toothpick.
If this is not sufficient, soften the encrustations by soaking the grounds container in water for a few minutes.



Important! Grounds container **MUST** be emptied every time the service door is open, even if container is not full as the counter will reset. If this is not done, the grounds container may fill up past capacity and damage the machine. Grounds container will display light every 14 single shots or 7 double shots. (This cleaning task can be done without powering the machine off.)

Cleaning the spouts

1. Clean the nozzle (A15), ideally each time the frother is used, with a sponge or cloth (fig. 21).
2. Check regularly (about once a month) that the holes in the coffee spout (A14) are not blocked. If necessary, remove coffee deposits with a toothpick (fig. 26), sponge or stiff bristled kitchen brush.

Cleaning the coffee feed funnel

- Check regularly (about once a month) that the pre-ground coffee feed funnel is not blocked. If necessary, remove coffee deposits with a wooden skewer.

Cleaning the inside of the machine

1. Check regularly (about once a week) that the inside of the machine is not blocked. If necessary, remove coffee deposits with a toothpick, sponge or stiff bristled kitchen brush.
2. Remove the residues with a vacuum cleaner (fig. 27).

Cleaning the infuser

The infuser must be cleaned at least once a month.

! Important! The infuser (A8) may not be removed when the appliance is on. Do not attempt to use force to remove the infuser as this could damage the machine.

1. Turn the machine off.
2. Open the service door (fig. 24);
3. Remove the drip tray and grounds container (fig. 25);
4. Press the two red release buttons inwards and at the same time extract the infuser (fig. 28).

! Important! Do not use dish detergent to clean the infuser (A8). The detergent would remove the lubricant applied to the inside of the piston, causing the infuser to seize up and become unusable.

5. Soak the infuser in water for about 15 minutes, then rinse.

6. After cleaning, replace the infuser (A8) by sliding it onto the internal support and pin at the bottom, then push the PUSH symbol fully in until it clicks into place.

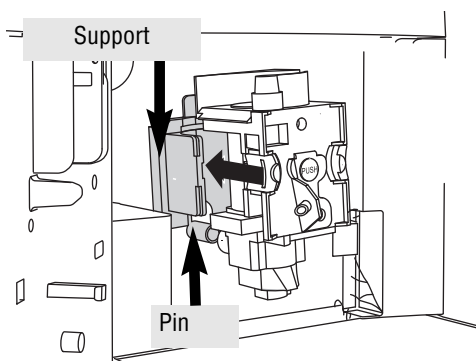

i NB! If you encounter difficulty inserting the infuser, before inserting it you must adapt it to the right dimension by pressing it forcefully from the bottom and top as shown in the figure.

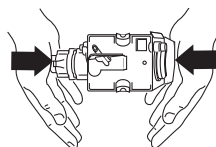

7. Once inserted, make sure the two red buttons have snapped out.
8. Replace the drip tray (A11) and grounds container (A9).
9. Close the service door (A12).

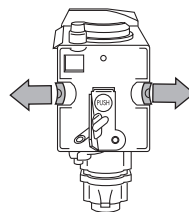

Cleaning the milk container

! Important! Always clean the tubes inside the milk container (B) when you prepare milk. If there is still milk in the container, do not leave it out of the refrigerator for longer than necessary. Clean the container each time you prepare milk as described in the section "Cleaning the milk container after use".

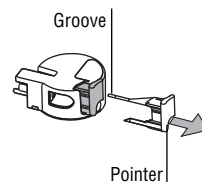
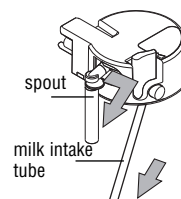

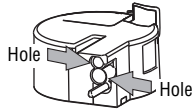

1. Turn the lid of the milk container clock-

- wise then remove it.
- Remove the milk spout and intake tube.
 - Remove the pointer by pulling it outwards.
 - Wash all the components thoroughly with hot water and mild dish detergent. Make sure there are no milk residues left inside the holes and the groove on the fine end of the pointer.
 - Check that the intake tube and spout are not clogged with milk residues.
 - Replace the pointer, milk spout and intake tube.
 - Replace the milk container lid.





DESCALING

Descal the machine when the red light  and the message "DESCALE" flash on the display.



 **Important!** Descaler contains acids which may irritate the skin and eyes. It is vital to respect the manufacturer's safety warnings given on the descaler pack and the warnings relating to the procedure to follow in the event of contact with the skin and eyes.

 **NB!** Failure to descale the appliance as described above voids the guarantee.

- Press the P button to enter the menu;
- Turn the selection knob until "Descaling" is displayed;
- Select by pressing the **OK** >  button. The message "Descaling Confirm?" is displayed. Press **OK** >  to activate the function.
- If the message "INSERT WATER SPOUT" is displayed, insert it (fig. 3).
- The message "Insert Descaler. Confirm?" is displayed.
- Empty the water tank (A7).
- Pour the descaler diluted with water (respecting the proportions indicated on the descaler bottle) into the water tank. Always use descaler recommended by De'Longhi (contact an authorized customer service center).
- Place an empty container with a minimum capacity of 50 oz under the hot water spout (B7) (fig. 3).



Important! Danger of burns Hot water containing acid runs out of the hot water spout. Avoid contact with splashes of water.

- Press the **OK** >  button to confirm that you have added the solution and begin the descaling procedure.
- The message "Descaling Underway" is displayed. After about 30 minutes, the message "Rinsing FILL TANK!" is displayed.
- Remove the water tank, empty, rinse with running water, fill with clean water and replace.
- Empty the container used to collect the descaler solution and replace it under the hot water spout.
- Press the **OK** >  button to start rinsing. Hot water runs out of the spout and the message "Rinsing..." is displayed.
- When the water tank is completely empty, the message "Rinsing Complete... Confirm?" is displayed.
- Press the **OK** >  button, fill the water tank and the appliance is ready for use.

SETTING WATER HARDNESS



The DESCALE message is displayed after a period of time established according to water hardness. The machine is factory set for a hardness value of 1.



The machine can also be programmed according to the hardness of your tap water. By programming the water hardness, the machine will adjust the frequency of the descaling message displayed.

Measuring water hardness

- Remove the "TOTAL HARDNESS TEST" indicator paper from its pack.
- Immerse the paper completely in a glass of water for one second.
- Remove the paper from the water and shake lightly.

Level 1  



Level 2  

Level 3  

Level 4  

After about a minute, 1, 2, 3, or 4 red squares form, depending on the hardness of the water. Each square corresponds to one level.

Setting water hardness

1. Press the P button to enter the menu.
 2. Turn the selection knob to select "Water Hardness".
 3. Confirm the selection by pressing the **OK** >  button.
 4. Turn the selection knob and set the level shown by the indicator paper (see previous paragraph).
 5. Press the **OK** >  button to confirm the setting.
 6. Press the  <ESC button to exit the menu.
- The machine is now reprogrammed with the new water hardness setting.

TECHNICAL SPECIFICATION

Voltage: 120 V~ 50/60 Hz max. 10A

Absorbed power: 1350W

Pressure: 15 bar

Water tank capacity: 60 ounces

Size: LxHxP: 10.7 x14.7x17.3 in

Weight: 25 lbs

DISPLAYED MESSAGES

DISPLAYED MESSAGE	POSSIBLE CAUSE	REMEDY
FILL TANK!	<ul style="list-style-type: none"> The water tank is empty or positioned incorrectly. 	<ul style="list-style-type: none"> Fill the tank with water and/or insert it correctly, pushing it as far as it will go until it clicks into place.
GROUND TOO FINE ADJUST MILL! Insert water spout and press ok	<ul style="list-style-type: none"> The grinding is too fine and the coffee runs off too slowly. The machine is not able to make coffee. 	<ul style="list-style-type: none"> Turn the grinding adjustment knob one click towards the 7. Insert the hot water spout, press the  button and run off water from the spout for a few seconds
INSERT WATER SPOUT!	<ul style="list-style-type: none"> The water spout is not inserted or is inserted incorrectly. 	<ul style="list-style-type: none"> Insert the hot water spout.
EMPTY GROUNDS CONTAINER	<ul style="list-style-type: none"> The grounds container (A9) is full. 	<ul style="list-style-type: none"> Empty the grounds container and clean, then replace. Important: when removing the drip tray, the grounds container MUST be emptied, even if it is not completely full. If this is not done, when you make the next coffees, the grounds container may fill up more than expected and clog the machine.
INSERT GROUNDS CONTAINER	<ul style="list-style-type: none"> After cleaning, the grounds container has not been replaced. 	<ul style="list-style-type: none"> Open the service door and insert the grounds container.
INSERT MILK CONTAINER!	<ul style="list-style-type: none"> The milk container is not inserted. 	<ul style="list-style-type: none"> Insert milk container.
ADD PRE-GROUND COFFEE!	<ul style="list-style-type: none"> The "pre-ground coffee" function has been selected without placing any pre-ground coffee in the funnel. 	<ul style="list-style-type: none"> Add the pre-ground coffee to the funnel or select the "coffee beans" function.

DISPLAYED MESSAGE	POSSIBLE CAUSE	REMEDY
DESCALE!	<ul style="list-style-type: none"> This indicates the presence of limescale in the machine. 	<ul style="list-style-type: none"> The descaling procedure described in the "Descaling" section needs to be performed as soon as possible.
LESS COFFEE!	<ul style="list-style-type: none"> The ground coffee funnel is clogged. Too many coffee beans or too much ground coffee has been added. 	<ul style="list-style-type: none"> Empty the funnel as described in the section "Cleaning the funnel to add coffee".. Select a milder taste or reduce the quantity of ground coffee, then run-off the coffee again.
FILL BEANS CONTAINER!	<ul style="list-style-type: none"> The coffee beans have run out. 	<ul style="list-style-type: none"> Fill bean container
INSERT INFUSER ASSEMBLY!	<ul style="list-style-type: none"> The infuser has not been replaced after cleaning. 	<ul style="list-style-type: none"> Insert the infuser as described in the paragraph "Cleaning the infuser".
CLOSE DOOR!	<ul style="list-style-type: none"> The service door is open 	<ul style="list-style-type: none"> Close the service door.
GENERAL ALARM!	<ul style="list-style-type: none"> The inside of the appliance is very dirty. 	<ul style="list-style-type: none"> Clean the inside of the appliance thoroughly, as described in the section "Cleaning and maintenance". If the message is still displayed after cleaning, contact a service center.

TROUBLESHOOTING

Below is a list of some of the possible malfunctions.

If the problem cannot be resolved as described, contact a Customer Service Center.

PROBLEM	POSSIBLE CAUSE	REMEDY
The coffee is not hot	<ul style="list-style-type: none"> The cups have not been preheated. The infuser has cooled down because 2 to 3 minutes have elapsed since the last coffee was made. 	<ul style="list-style-type: none"> Heat the cups by rinsing them in hot water or leaving them to rest for at least 20 minutes on the cup warmer tray. Before making coffee, heat the infuser by pressing the  button (fig. 29).
The coffee is not creamy enough	<ul style="list-style-type: none"> The coffee is ground too coarsely. Coffee type is not suitable. 	<ul style="list-style-type: none"> Turn the grinding adjustment knob one click anticlockwise towards the 1 while the coffee mill is in operation (fig. 7). Use a type of coffee for espresso coffee makers.
The coffee runs out too slowly or in drips.	<ul style="list-style-type: none"> The coffee is ground too finely. 	<ul style="list-style-type: none"> Turn the grinding adjustment knob one click clockwise towards the 7 while the coffee mill is in operation (fig. 7). Continue one click at a time until coffee run-off is satisfactory.
The coffee runs out too quickly.	<ul style="list-style-type: none"> The coffee is ground too coarsely. 	<ul style="list-style-type: none"> Turn the grinding adjustment knob one click anticlockwise towards the 1 while the coffee mill is in operation (fig. 7). Avoid turning the grinding coarseness regulator excessively otherwise when you select 2 cups, the coffee may run out in drips.

PROBLEM	POSSIBLE CAUSE	REMEDY
The coffee does not come out of one of the spouts.	<ul style="list-style-type: none"> The spouts are blocked. 	<ul style="list-style-type: none"> If necessary, remove coffee deposits with a toothpick (fig. 26), sponge or stiff bristled kitchen brush.
The coffee does not come out of the spouts, but around the service door (A12).	<ul style="list-style-type: none"> The holes in the spouts are clogged with dry coffee dust. The coffee guide (A13) inside the service door is blocked and cannot swing. 	<ul style="list-style-type: none"> If necessary, remove coffee deposits with a toothpick, sponge or stiff bristled kitchen brush (fig. 26). Thoroughly clean the coffee guide (A13), particularly near the hinges.
Water comes out of the spouts instead of coffee.	<ul style="list-style-type: none"> The ground coffee may be blocked in the funnel (A4). 	<ul style="list-style-type: none"> Clean the funnel (A4) with a wooden or plastic fork, clean the inside of the machine.
The milk does not come out of the milk spout (B5).	<ul style="list-style-type: none"> The intake tube is not inserted or is inserted incorrectly. 	<ul style="list-style-type: none"> Insert the intake tube (B4) in the rubber washer in the milk container lid (fig. 16).
The milk is not well frothed.	<ul style="list-style-type: none"> The milk container lid is dirty. 	<ul style="list-style-type: none"> Clean the milk container lid as described in the section "Cleaning the milk container".
The milk contains bubbles or squirts out of the milk spout.	<ul style="list-style-type: none"> The milk is not cold enough or is not skimmed. The milk frother slide is incorrectly adjusted. 	<ul style="list-style-type: none"> You should ideally use skimmed milk at refrigerator temperature (about 41°F). If the result is not as you wished, try changing brand of milk. Move the slide slightly towards the word "CAFFELATTE" (see section "Making cappuccino").

This warranty applies to Super Automatic Espresso Machines with the De'Longhi brand name.

LIMITED WARRANTY

What does the warranty cover?

We warrant each appliance to be free from defects in material and workmanship. Our obligation under this warranty is limited to repair at our factory or authorized service center of any defective parts or part thereof, other than parts damaged in transit. The repaired or new model will be returned at the company expense. This warranty shall apply only if the appliance is used in accordance with the factory directions, which accompany it, and on an alternating current (AC) circuit.

How long does the coverage last?

This warranty runs for two years (2) from the purchase date found on your receipt and applies only to the original purchaser for use.

What is not covered by the warranty?

The warranty does not cover defects or damage of the appliance, which result from repairs or alterations to the appliance outside our factory or authorized service centers, nor shall it apply to any appliance, which has been subject to abuse, misuse, negligence or accidents. Also, consequential and incidental damage resulting from the use of this product or arising out of any breach of contract or breach of this warranty are not recoverable under this warranty. Some states do not allow the exclusion or limitation of incidental or consequential damage, so the above limitation may not apply to you.

How do you get service?

If repairs become necessary, see contact information below:

U.S. Residents:

Please contact our toll free hotline at #1-866-Latte-Best (Hours of Operation: Monday - Friday 8:30am - 8pm, Saturday 9:30am - 5:30pm) or log onto our website at www.delonghi.com.

For all accessories, spare parts or replacement parts, please contact our parts division at 1-866-528-8323.

Residents of Canada:

Please contact our toll free hotline at #1-866-Latte-Best or 1-866-528-8323 or log onto our website at www.delonghi.com.

Residents of Mexico:

Please refer to the Limited Warranty statement for Mexico (see page 66).

Please refer to the back page of the manual for De'Longhi addresses.

The above warranty is in lieu of all other express warranties and representations. All implied warranties are limited to the applicable warranty period set forth above. This limitation does not apply if you enter into an extended warranty with De'Longhi. Some states do not allow limitations on how long an implied warranty lasts, so the above exclusions may not apply to you. De'Longhi does not authorize any other person or company to assume for it any liability in connection with the sale or use of its appliance.

How does state law apply?

This warranty gives you specific legal rights, and you may also have other rights, which vary from state to state.



De'Longhi America, Inc.

Park 80 West, Plaza One
Saddle Brook, NJ 07663
#1-866-Latte-Best
1-866-528-8323

De'Longhi Canada, Inc.

6150 McLaughlin Road
Mississauga, Ontario
L5R 4E1 Canada
#1-866-Latte-Best
1-866-528-8323

Fiducia Italiana S.A de C.V.

Pestalozzi 814
Col. Del Valle
Del. Benito Juarez
México D.F. 03100
tels: 5543 1447 y 5543 6492
Lada sin costo: 01800 711 8805

www.delonghi.com