



De'Longhi America, Inc.
Park 80 West, Plaza One
Saddle Brook, NJ 07663
#1-866-Latte-Best
1-866-528-8323

De'Longhi Canada, Inc.
6150 McLaughlin Road
Mississauga, Ontario
L5R 4E1 Canada
#1-866-Latte-Best
1-866-528-8323

FIDUCIA ITALIANA S.A DE C.V
Pestalozzi #814
Col. Narvarte
Del. Benito Juarez
C.P. 03100
tels: 5543 1447
lada sin costo: 01 800 711 8805

www.delonghi.com



**IMPORTANT INSTRUCTIONS
SAVE THESE INSTRUCTIONS**

**MODE D'EMPLOI IMPORTANT
CONSERVEZ LES PRESENTES INSTRUCTIONS**

**INSTRUCCIONES IMPORTANTES
REPASE Y GUARDE ESTAS INSTRUCCIONES
LEA ESTE INSTRUCTIVO ANTES DE UTILIZAR EL APARATO**

**ISTRUZIONI IMPORTANTI
CONSERVARE LE ISTRUZIONI**

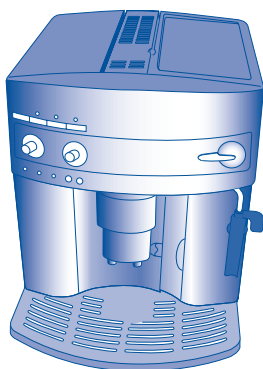

**COFFEE MAKER TYPE ESAM3300/CAFETERIE MODÈLE ESAM3300/
CAFETERA ELECTRICA MODELO ESAM3300/ MACCHINA DA CAFFÈ ESAM3300**

Register this product on-line and receive a free trial issue of Cook's Illustrated. Visit www.prodregister.com/delonghi.
Visit www.delonghi.com for a list of service centers near you. (U.S. and Canada)

Enregistrez ce produit en ligne et recevez un numéro gratuit de Cook's Illustrated. Visitez www.prodregister.com/delonghi.
Visitez www.delonghi.com pour y voir une liste des centres de réparation proches de chez vous. (É.-U. et Canada).

Registre este producto en línea y reciba un ejemplar gratis de Cook's Illustrated. Visite www.prodregister.com/delonghi.
Visite www.delonghi.com para ver la lista de centros de servicios cercanos a usted. (Estados Unidos y Canada)

Registra questo prodotto "on-line" per ricevere una copia omaggio della rivista. Visita www.prodregister.com/delonghi.
Visita www.delonghi.com per una lista dei centri di servizio a te più vicini. (Stati Uniti e Canada)

**ELECTRONIC CHARACTERISTICS: CARACTÉRISTIQUES ÉLECTRIQUES: CARACTERISTICAS ELECTRICAS:
CARATTERISTICHE ELETTRICHE: 120V-60HZ 1350W**

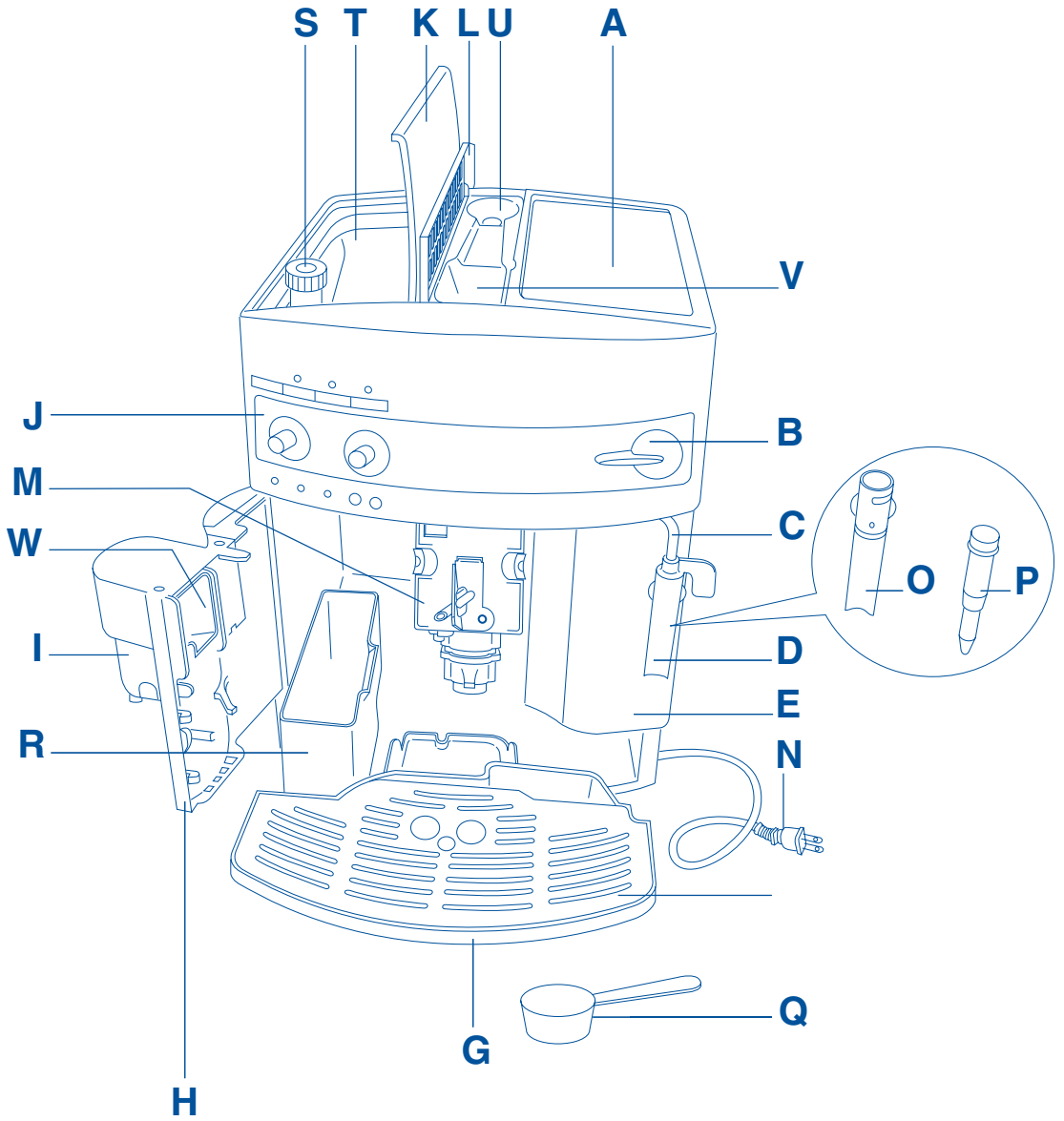

Coffee has been used to factory test the appliance and it is, therefore, completely normal for there to be traces of coffee in the mill. This appliance is, however, guaranteed to be new.

Important safeguards	5
1 Description of the appliance (see page 3)	6
2 Safety warnings	7
3 Installation	7
4 Preparing the coffee maker	8
4.1 Filling the water tank	8
4.2 Filling the container with coffee beans	8
4.3 Using the coffee maker for the first time	8
5 Preparing coffee (using coffee beans)	9
6 Regulating the coffee mill	11
7 Preparing espresso/coffee with ground coffee (instead of beans)	12
8 Producing Hot Water	12
9 Preparing cappuccinos (using steam)	13
10 Cleaning and maintenance	14
10.1 Cleaning the coffee maker	14
10.2 Cleaning the infuser	15
10.3 Descaling	16
10.4 Setting the water hardness	17
11 Meaning of the normal operation indicator lights	18
12 Troubleshooting	19
13 Problems that can be resolved before calling the service center	20
Limited warranty	22

IMPORTANT SAFEGUARDS

When using electrical appliances, basic safety precautions should always be followed, including the following:

- Read all instructions.
- Do not touch hot surfaces. Use handles and knobs.
- To protect against fire, electrical shock and personal injury, do not immerse cord, plug or appliance in water or other liquid.
- Never allow the appliance to be used by children.
- Unplug from the outlet when not in use and before cleaning. Allow to cool before fitting or taking off parts, and before cleaning the appliance.
- Do not operate with a damaged cord or plug, or after the appliance malfunctions, or has been damaged in any manner. Return the appliance to the nearest authorized service facility for examination, repair or adjustment.
- The use of accessory attachments or spare parts not recommended by the appliance manufacturer may result in fire, electrical shock or personal injury.
- Do not use outdoors.
- Do not let the cord hang over the edge of the table or counter, or touch hot surfaces.
- Do not place on or near a hot gas or electrical burner, or in a heated oven.
- Plug cord into the wall outlet. To disconnect, turn any control to "off", then remove plug from wall outlet.
- Do not use the appliance for other than the intended use. This appliance is to be utilized for domestic use only. Any other use is to be considered improper and therefore, dangerous.

WARNING: To reduce the risk of fire or electric shock, do not remove the cover.

No user serviceable parts inside. Repair should be done by authorized service personnel only!

SAVE THESE INSTRUCTIONS

THIS PRODUCT IS FOR HOUSEHOLD USE ONLY

SHORT CORD INSTRUCTIONS

- A short power cord is provided to reduce risks resulting from becoming entangled in or tripping over a longer cord.
- Longer, detachable power supply cords or extension cords are available and may be used if care is exercised in their use.
- If an extension cord is used, the marked electrical rating should be at least as great as the electrical rating of the appliance. If the appliance is provided with 3- wire, grounding type cord, the extension should be a GROUNDING TYPE 3 - WIRE CORD. The longer cord should be arranged so that it will not drape over the counter-top or table top where it can be pulled on by children or tripped over.
- Your product is equipped with a polarized alternating current line plug (a plug having one blade wider than the other). This plug will fit into the power outlet only one way. This is a safety feature. If you are unable to insert the plug fully into the outlet, try reversing the plug. If the plug should still fail to fit, contact your electrician to replace your obsolete outlet. Do not defeat the safety purpose of the polarized plug.

1. DESCRIPTION OF THE APPLIANCE (SEE PAGE 3)

- | | |
|--|---|
| <ul style="list-style-type: none"> A. Cup warmer tray B. Steam knob C. Steam spout D. Patented Cappuccino System Frother (Milk Frother) E. Water tank (removable) F. Cup support tray G. Drip tray (removable) H. Service door I. Coffee spout, adjustable in height J. Control panel K. Bean container lid | <ul style="list-style-type: none"> L. Central lid for the ground coffee M. Infuser N. Power cable O. Removable Milk Frother Body P. Removable Steam Nozzle Q. Measuring scoop for pre-ground coffee R. Coffee grounds container (removable) S. Grinding coarseness regulator T. Coffee bean container U. Compartment for measuring scoop V. Ground coffee funnel W. Mobile drawer |
|--|---|

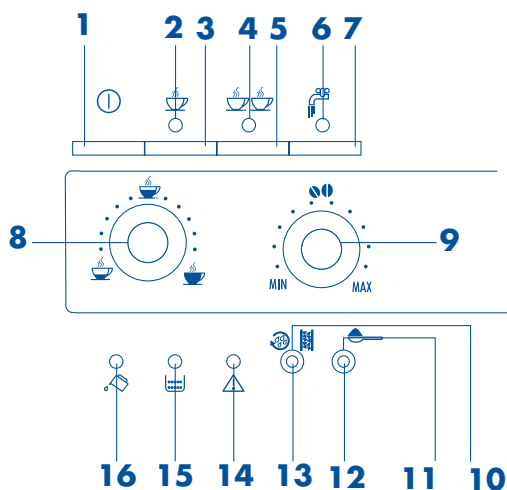

Control panel

- | | |
|--|---|
| <ul style="list-style-type: none"> 1) On/off button 2) 1 cup and coffee temperature ready light 3) One cup button 4) 2 cup and coffee temperature ready light 5) Two cup button 6) Hot water or steam indicator light 7) Hot water selection button 8) Coffee quantity selector dial (short, normal or long) | <ul style="list-style-type: none"> 9) Coffee flavor dial (for weak, normal or strong coffee) 10) Rinse and decalcification button 11) Ground coffee button (disables the coffee grinder) 12) Ground coffee light (coffee grinder disabled) 13) Decalcification warning light 14) General warning indicator light 15) Grounds container indicator light (full/missing) 16) Water indicator light (empty/missing) |
|--|---|

2 SAFETY WARNINGS

CAREFULLY READ AND KEEP THESE INSTRUCTIONS!

- This machine is designed to “make espresso coffee” and “hot drinks”. Be careful to avoid scalding from the water and steam jets or by using the machine incorrectly.
- This appliance is for household use only. All other use is considered improper and consequently dangerous.
- The manufacturer is not liable for damage caused by improper, incorrect or unreasonable use of the appliance.
- During operation, do not touch the hot surfaces of the appliance. Use the knobs or handles.
- Do not touch the appliance with damp hands or feet.
- Do not allow children or unfit persons to use the appliance unsupervised.
- Do not allow children to play with the appliance.
- In the event of breakdown or faulty operation, turn the appliance off and do not tamper with it. For repairs, contact a technical service center authorized by the manufacturer only. Request that only original spare parts be used. Failure to respect the above may compromise the safety of the appliance.

3 INSTALLATION

- After unpacking, make sure the appliance is complete and undamaged. If in doubt, do not use it. Contact professionally qualified personnel.
- Packing elements (plastic bags, polystyrene etc) must not be left within reach of children as they may represent a hazard.
- Place the appliance on a work surface far away from water taps, basins and sources of heat.
- **After having positioned the appliance on the work bench, make sure that there is a free space of around 2 in. between the surfaces of the appliance and the side and rear walls and a free space of at least 8 in. above the coffee maker.**
- Never install the machine in environments where the temperature may reach freezing or below freezing temperatures (the appliance could be damaged if the water freezes).
- Check that the voltage of the mains power supply corresponds to the value indicated on the appliance’s rating plate. Only connect the appliance to a power outlet with a minimum rating of 10A that is properly grounded. The manufacture is not liable for possible accidents caused by failure to do so.
- If the power outlet does not match the plug on the appliance, have the outlet replaced with a suitable type by qualified personnel.
- The power cable for this appliance must not be replaced by the user as this operation requires the use of special tools. If the cable is damaged or requires replacing, contact an authorized service center only to avoid all risks.
- The water hardness should be set as soon as possible, following the procedure described in chapter 10.4.

To correctly learn how to use the machine, when starting it for the first time, carefully follow the step-by-step instructions described in the following paragraphs.

4 PREPARING THE COFFEE MAKER

4.1 FILLING THE WATER TANK

- Remove the water tank (Fig.1), rinse it and fill it with fresh water, never exceeding the MAX line. When removing the tank, the milk frother must always be positioned towards the center of the machine, otherwise the tank cannot be removed.
- Replace the tank, **pushing it all the way in**.

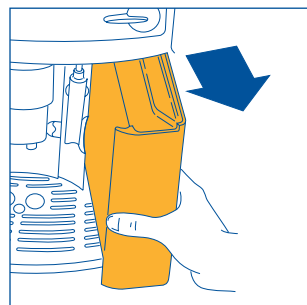

Fig.1

4.2 FILLING THE CONTAINER WITH COFFEE BEANS

- Open the lid on the coffee bean container (Fig.2).
- Fill the container with coffee beans.
- Close the lid.

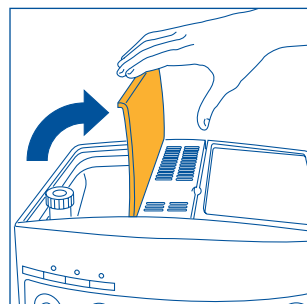





Fig.2

WARNING: To avoid malfunctions, never fill with ground coffee, freeze-dried coffee or caramelized beans, or other objects that may damage the machine.

4.3 USING THE COFFEE MAKER FOR THE FIRST TIME

1. Check that the water tank is full and the power cable is plugged into the power outlet.
2. Move the milk frother towards the outside and place a cup underneath (Fig.3). Then turn the machine on by pressing the  button (Fig.4).
3. **IMMEDIATELY AFTER, WITHIN A MAXIMUM OF 30 SECONDS**, turn the steam knob counter-clockwise until it stops (Fig.5) (it is normal for the machine to make some noise).
4. After few seconds, a little water will release from the milk frother. When the cup is 1/3 full, turn the steam knob half a turn clockwise (Fig.6) to terminate the flow of water.
5. Wait for the  and  lights to stop flashing. The flashing lights indicate the machine is preheating. Before the lights stop flashing the machine will automatically perform a rinse cycle and a little hot water will release from the coffee spouts and collect in the drip tray. Once the lights illuminate steadily, the machine has reached the ideal temperature for making coffee.
Tip: for a hotter short coffee (less than 2 oz.); first fill the cup with the hot rinsing water. Then leave it inside for a few seconds (before emptying it) so as to pre-heat the cup.
6. At this point, the machine is ready for use.

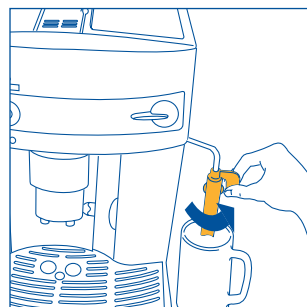

Fig.3

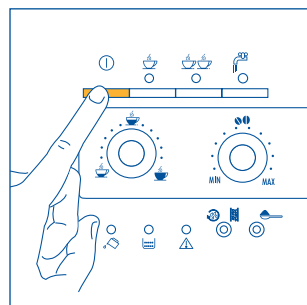









Fig.4

5 PREPARING COFFEE (USING COFFEE BEANS)

- 1) Before preparing the coffee, always make sure that the green  and  lights are steady and the water tank and coffee bean container are full.
- 2) Adjust the coffee flavor dial (Fig. 7) to set the desired taste of the coffee. Turning the knob clockwise increases the quantity of coffee beans that the machine will grind, and thus makes the taste of the coffee stronger. When using the machine for the first time, the correct position of the knob can be found by trial and error. Make sure not to turn it too far clockwise, otherwise the coffee will be delivered too slowly (in drips), in particular when preparing two cups of coffee.
- 3) Adjust the coffee quantity selector dial (Fig. 8) to set the quantity of coffee required. Turning the knob clockwise makes a longer coffee. When using the machine for the first time, the correct position of the knob can be found by trial and error.
- 4) Place one cup under the coffee spout to make 1 coffee (Fig. 9) or 2 cups for 2 coffees (Fig. 10). For a creamy coffee, lower the coffee spout to bring them as close to the cups as possible (Fig. 11).
- 5) Press the  button (Fig. 12) to make one cup of coffee or the  button (Fig. 13) to make 2 coffees. *At this point the machine grinds the beans, runs a short pre-infusion cycle, a pause and then completes the delivery.*
Once the desired quantity has been reached, the machine automatically stops delivering the coffee and discharges the grounds into the coffee grounds container.
- 6) After a few seconds, when both the green  and  indicator lights are steady, another coffee can be made.
- 7) To switch the machine off, press the  button. (Before switching off, the machine automatically runs a rinse cycle: a little hot water runs out of the spout and is collected in the drip tray underneath - be careful, to avoid scalds). If the machine is not switched off using the  button, it will switch itself off and run a brief rinse cycle 3 hours after the last operation.

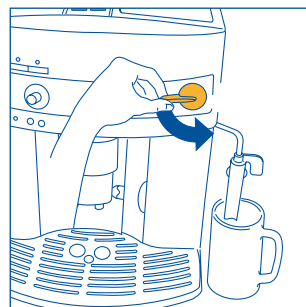

Fig.5

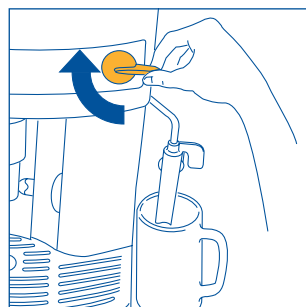

Fig.6

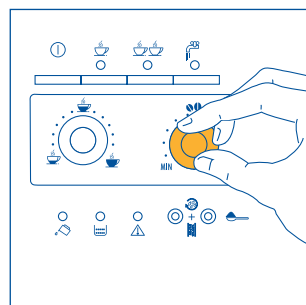

Fig.7

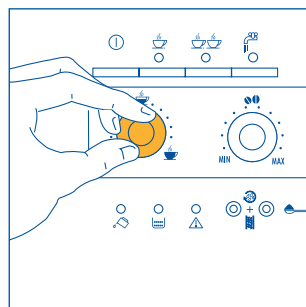



Fig.8

NOTE 1: If the coffee is delivered a drop at a time or not at all, turn the grinding coarseness regulator (fig. 17) one click clockwise (see section 6). Turn a click at a time until the coffee is delivered satisfactorily.

NOTE 2: If the coffee is delivered too fast and is not creamy enough, turn the coffee flavor dial (fig. 7) clockwise. Proceed by trial and error to find the correct position of the dial. Make sure not to turn the dial too far clockwise, otherwise the delivery may become too slow (in drips), in particular when making two cups of coffee. If, after several coffees, the cream is still not satisfactory, also turn the grinding coarseness regulator (Fig. 17) one click counter-clockwise (see section 6).

NOTE 3: Tips on making hotter coffee:

1) If, when the machine has just been turned on, a short cup of coffee is required (less than 2 oz), use the hot rinsing water to pre-heat the cups (see suggestion in section 4.3, point 5). If, on the other hand, more than 2-3 minutes have elapsed since the last coffee was made, before preparing **another coffee the infuser must be pre-heated, pressing the  button (Fig. 14).**

Run off the water into the underlying drip tray or alternatively use this water to fill (and then empty) the cup to be used for the coffee, so as to pre-heat it.

2) Unless preheated, do not use cups that are too thick, as they will absorb too much heat.

3) Use cups that have been previously heated by rinsing them with hot water or alternatively by leaving them for at least 20 minutes on the cup warmer tray on top of the machine with the appliance on.

NOTE 4: while the machine is making the coffee, the delivery can be stopped at any time by pressing the ☺ button (Fig. 12) or ☺☺ button (Fig. 13), as previously selected.

NOTE 5: as soon as delivery is complete, to increase the quantity of coffee, simply press and hold the ☺ button (Fig. 12) or ☺☺ button (Fig. 13), as previously selected, until the desired quantity is reached (this operation must be performed within 3 seconds from when coffee delivery from the spouts ceases).

NOTE 6: when the ⚡ indicator light comes on (section 12, point 1), the water tank must be filled, otherwise the coffee cannot be made. The water tank can only be removed if the milk frother is first positioned towards the center of the machine. (It is normal for there to be a little water left in the tank when the ⚡ indicator light comes on).

NOTE 7: the machine counts the number of cups of coffee made. Each 14 single cups (or 7 double cups), the 📊 light switches on steady (section 12 point 3), warning the user that the grounds container is full and must be emptied and cleaned. Until the grounds container has been cleaned, the light will remain on and the machine cannot deliver coffee. To clean the container, open the service door on the front (pulling the handle, Fig. 15), the ⚠ light flashes (see section 12, point 9); remove the drip tray (Fig. 16), empty and clean. Empty and carefully clean the grounds container, making sure to remove all the residue that may be deposited on the bottom. Also, dry off any condensation that may have formed that may have formed inside the machine under the drip tray. **IMPORTANT: when removing the drip tray, the grounds container MUST be emptied, even if it is not completely full. If this is not done, when making your next coffee, the grounds the grounds container may fill over the maximum level and block the machine.**

NOTE 8: the grinder in the coffee maker may become worn over time and consequently the coffee will change taste as it is ground more coarsely.

To resolve this problem, re-set the grinding coarseness by adjusting the regulator (Fig. 17) one click counter-clockwise (as described in chap. 6).

NOTE 9: if the machine is not used for a long period, the infuser must be cleaned, as described in section 10.2.

NOTE 10: while the machine is delivering coffee, never remove the water tank. If it is removed, the machine will not be able to make the coffee and the ⚡ indicator light will flash. If you try to make another coffee, the machine becomes noisy and does not make the coffee. To reset the machine, turn the steam knob counter-clockwise as far as it will go and run off water from the milk frother for a few seconds.

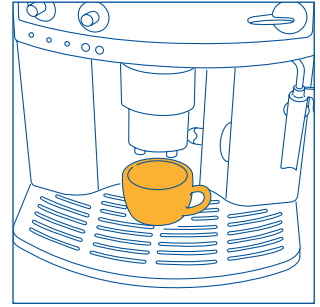

Fig. 9

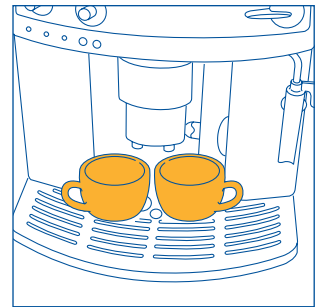

Fig. 10

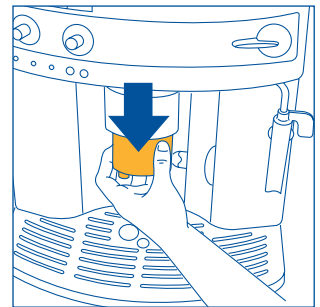

Fig. 11

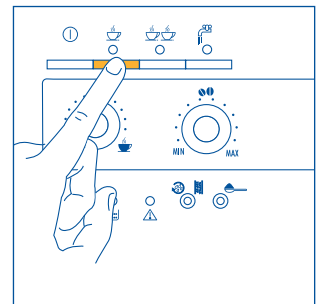

Fig. 12

When using the machine for the first time, 4-5 cups of coffee need to be made before the machine starts to give satisfying results.

If the machine malfunctions, do not contact the service center right away. The problems can almost always be resolved by following the instructions indicated in sections 12 and 13. If this is not the case, or for further explanations, contact customer service by calling the number listed in the warranty or visit www.delonghi.com for a list of service centers near you. (U.S. and Canada).

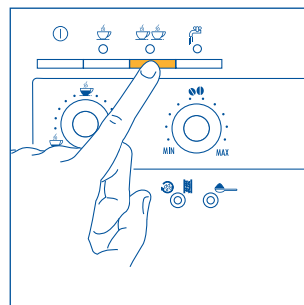

Fig. 13

6 ADJUSTING THE COFFEE GRINDER

The coffee grinder must not be adjusted, at least initially, as it has already been factory preset to deliver the correct quantities of coffee.

Nonetheless, after having made the first coffees, if delivery is too fast or too slow (in drips), the grinding coarseness regulator can be adjusted (Fig. 17). Turning one click (one number) clockwise achieves faster delivery of the coffee (without drips).

Turning one click counter-clockwise slows down delivery giving a creamier appearance to the coffee.

These adjustments will only be evident after the delivery of at least 2 cups of coffee.

The grinding coarseness regulator must only be turned when the coffee grinder is running.

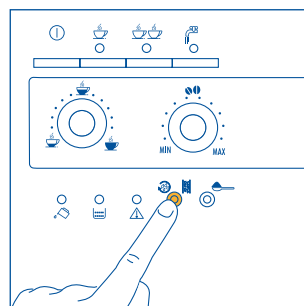

Fig. 14

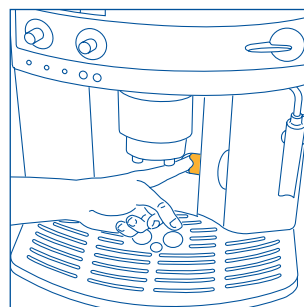
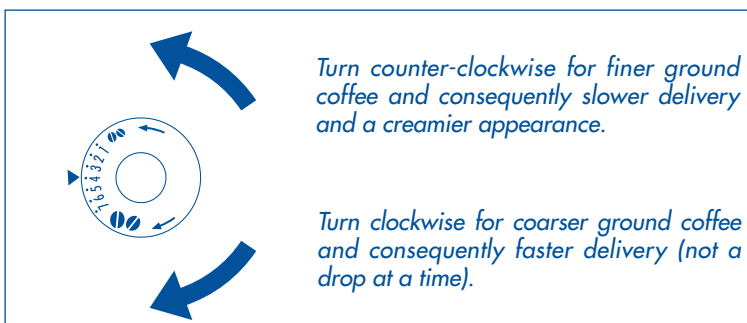

Fig. 15

NOTE 1: Coffee has been used to factory test the appliance and it is, therefore, completely normal for there to be traces of coffee in the grinder (mill). This appliance is, however, guaranteed to be new.

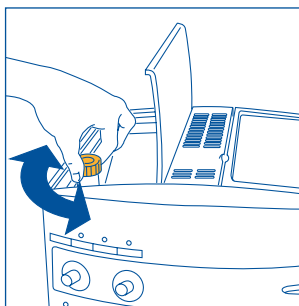

Fig. 17

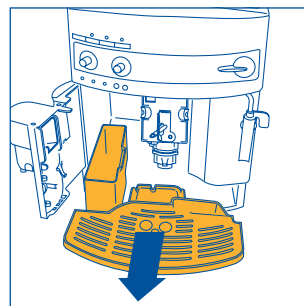



Fig. 16

7 PREPARING ESPRESSO COFFEE WITH GROUND COFFEE (INSTEAD OF BEANS)

1. Press the  button to select the ground coffee function (Fig. 18). The ground coffee light will illuminate indicating the function has been selected and the coffee grinder has been disabled.
 2. Lift the lid in the center, place one measuring scoop of ground coffee in the funnel (see fig. 19) and proceed as described in section 5.
- Note: You can make just one coffee at a time by pressing the .

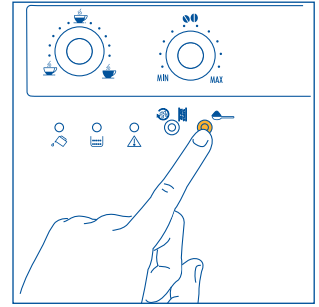

Fig. 18

NOTE 1: Never add the ground coffee when the machine is off, to prevent it from spilling inside the machine.

NOTE 2: Never add more than 1 measure, otherwise either the machine will not make the coffee and the pre-ground coffee will be lost inside the machine, dirtying it, or the coffee will be run off in drips.



NOTE 3: When measuring the quantity of coffee to be added, use the measuring scoop supplied only.

NOTE 4: Only use ground coffee for espresso coffee makers. Do not use coffee beans, freeze-dried coffee or other materials that may damage the machine.

NOTE 5: If you add more than one measure of pre-ground coffee and the funnel blocks, use a plastic knife to push the coffee down (Fig. 20), then remove and clean the infuser and the machine, as described in section 10.2 "Cleaning the infuser".

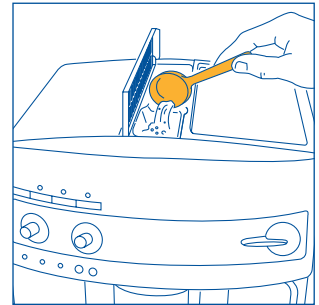



Fig. 19

3. Once the coffee has been delivered, to make coffee using the beans again, deactivate the ground coffee function by pressing the  button again (the light goes off and the coffee grinder is enabled for operation again).

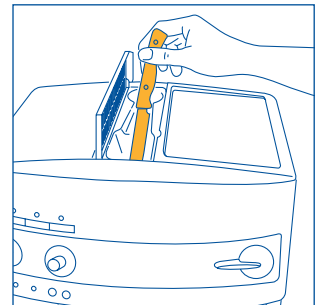







Fig. 20

8 HOT WATER DELIVERY

- Always make sure the green  and  lights are on steady.
- Turn the cappuccino frother towards the outside of the machine (Fig. 3).
- Position a container underneath the milk frother (Fig. 3).
- Press the  button (fig. 21). The  light comes on to indicate that the function has been selected.
- Turn the steam knob half a turn in counter-clockwise until it stops (Fig. 5): hot water will come out of the milk frother and start to fill the container underneath.
- To stop the flow of hot water, turn the knob all the way clockwise (Fig. 6) and return the cappuccino frother to the original position towards the center of the machine.
- Press the  button (fig. 21). (It is recommended to deliver hot water for no more than 2 minutes).

9 PREPARING CAPPUCCINOS (USING STEAM)

- Move the cappuccino frother outwards (fig. 3).
- Place an empty container under the cappuccino frother (fig. 3). Turn the steam knob a half turn counter-clockwise as far as it will go (the light flashes fig. 22). Run off the steam mixed with water for a few seconds until only steam is gone off.
- Then interrupt steam delivery by rotating the knob clockwise as far as it will go (fig. 6).
- Empty the container and fill it with about 3.5 oz. of milk for each cappuccino to be prepared. In choosing the size of the container, bear in mind that the milk increases in volume by 2 or 3 times. **You are recommended to use skim or 2% milk at refrigerator temperature (about 41°F/5°C).**
- Dip the cappuccino frother into the into the container with milk (fig. 23), taking care not to immerse the raised line on the cappuccino frother (indicated by the arrow in fig. 24). Turn the steam knob a half turn counter-clockwise as far as it will go (take care to avoid scalds). Steam is discharged from the cappuccino maker, giving the milk a creamy frothy appearance. To obtain a creamier froth, dip the cappuccino frother into the milk and rotate the container with slow movements from the bottom upwards. (You should not discharge steam for more than two minutes at a time).
- Once the desired temperature has been reached, stop the steam by turning the steam knob clockwise until it stops (Fig. 6).
- Prepare the coffee as described in section 5, using large enough cups, then fill with the frothed milk prepared previously. The cappuccino is ready. Sweeten to taste and if desired, sprinkle the froth with a little cocoa powder.

NOTE 1: The cappuccino frother must always be cleaned after use. Proceed as follows:

- Release a little steam for a few seconds by turning the steam knob counter-clockwise until it stops (Fig. 5). With this operation, the steam spout discharges any milk that may be left inside. **IMPORTANT:** For hygiene reasons, this operation should always be performed, so as to prevent previously used milk from remaining inside the cappuccino frother.
- Turn the knob clockwise as far as it will go. With one hand, hold the cappuccino frother handle firm and with the other unscrew the cappuccino frother cover itself by rotating clockwise and extracting downwards (fig. 25).
- Remove the steam nozzle from the delivery spout by pulling it downwards (Fig. 26).
- Carefully wash the cappuccino frother and the steam nozzle in warm water.

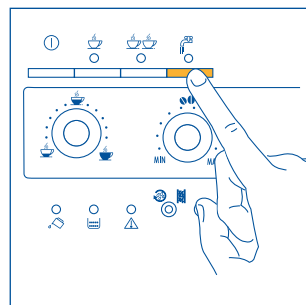

Fig.21

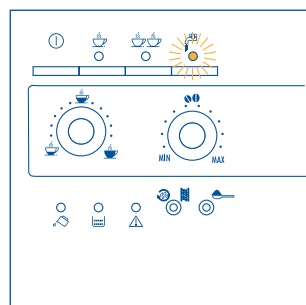

Fig.22

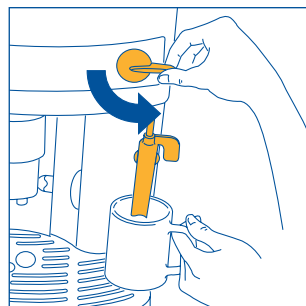

Fig.23

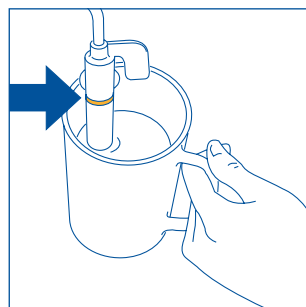



Fig.24

- Check that the two holes indicated by the arrows in Fig. 27 are not clogged. If necessary, clean them using a needle or pin.
- Replace the steam nozzle by inserting it and vigorously turning it upwards into the steam spout.
- Replace the cappuccino frother cover by pushing it upwards and turning it counter-clockwise.

10 CLEANING AND MAINTENANCE

- Before performing any cleaning operations, the machine must have cooled down and must be disconnected from the mains power supply.
- Never immerse the machine in the water: it is an electrical appliance.
- Do not use solvents or abrasive detergents to clean the coffee maker. A soft damp cloth will suffice.
- The infuser, grounds container, water tank and drip tray must NEVER be washed in the dishwasher.

10.1 CLEANING THE COFFEE MAKER

- Clean the grounds container (as described in section 5, note 7) whenever the  light comes on steady (section 12 - point 3).
- The water tank should be cleaned regularly.
- The drip tray is fitted with a level indicator (red) showing the level of water inside. When the indicator starts to become visible (a few millimeters under the drip tray), the drip tray must be emptied and cleaned.
- Check that the holes in the coffee delivery spout are not blocked. To clean them, scrape the dry coffee residues with a needle (Fig. 28).

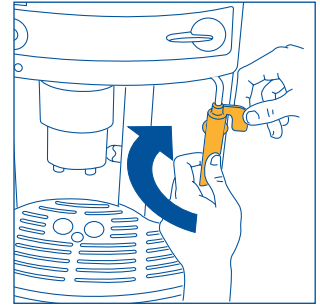

Fig.25

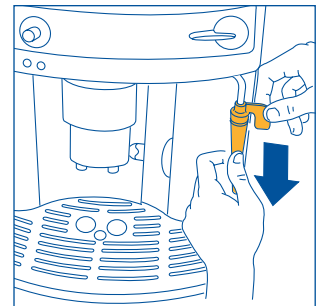

Fig.26

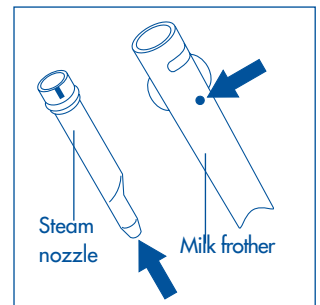

Fig.27

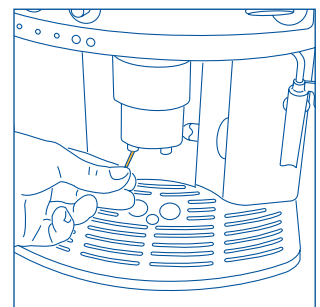

Fig.28

10.2 CLEANING THE INFUSER

The infuser must be cleaned regularly to prevent it from filling with coffee deposits (that may lead to malfunctions). To clean it, proceed as follows:

- turn the machine off by pressing the ① button (Fig. 4) (do not unplug it) and **wait for all the indicator lights to go off**;
- open the service door (Fig. 15);
- remove the drip tray and the grounds container (Fig. 16) and clean them;
- press the two red release buttons on the infuser sideways and towards the center (Fig. 29) and pull it out;

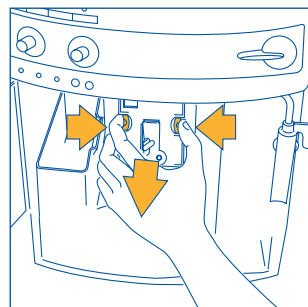

Fig.29

WARNING: THE INFUSER CAN ONLY BE REMOVED WHEN THE MACHINE IS OFF. ATTEMPTING TO REMOVE THE INFUSER WITH THE MACHINE ON MAY CAUSE SERIOUS DAMAGE.

- wash the infuser under running water, without using detergents.
Never wash the infuser in the dishwasher;
- carefully clean the inside of the machine. To remove the coffee stuck to the parts inside the machine, scrape it with a plastic or wooden fork (Fig. 30) and then pick up all the residues using a vacuum cleaner (Fig. 31);
- Replace the infuser by sliding it onto the supports and the pin at the bottom; **then push the PUSH symbol fully in until it clicks into place.**

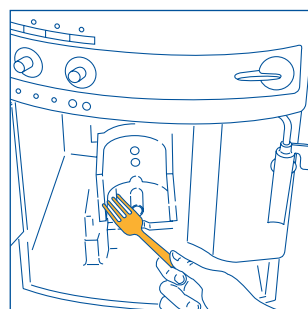

Fig.30

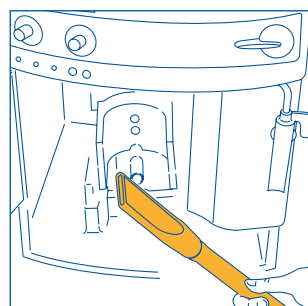
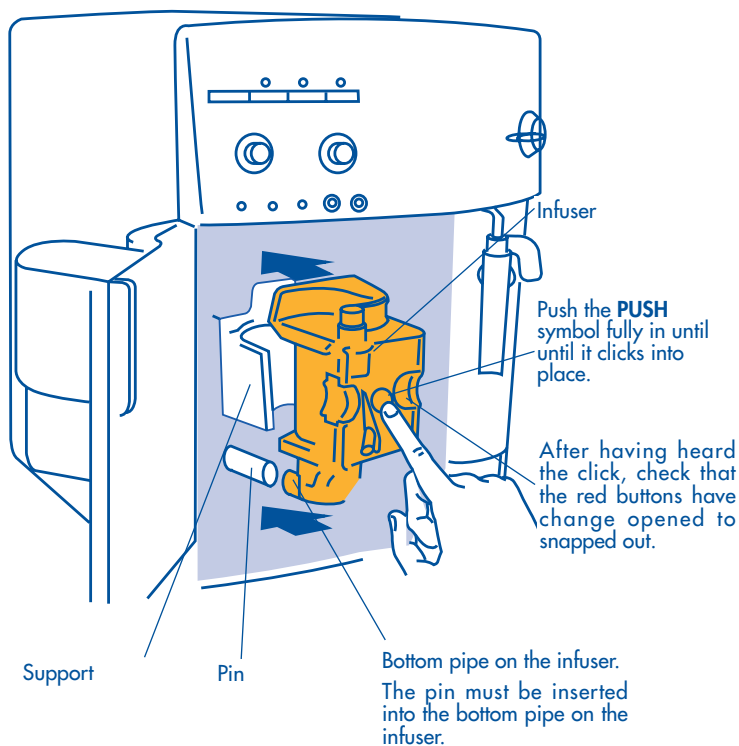
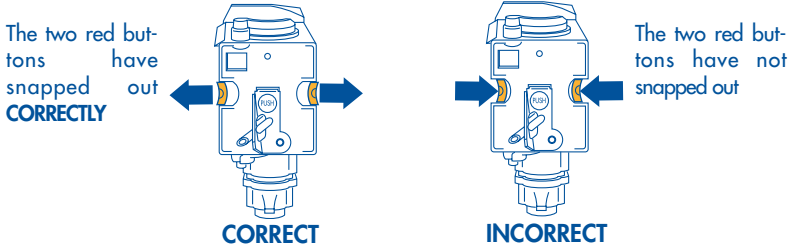

Fig.31



Check that the two red buttons have snapped out, otherwise the door cannot be closed.



NOTE 1: If the infuser is not inserted correctly, until it clicks into place, and the two red buttons have not snapped out, the service door will not close and the machine will not operate (when switching on the machine the \triangle light starts flashing (section 12 - point 9)).

NOTE 2: if it is hard to insert the infuser, (before inserting it) squeeze it into size by pressing it vigorously from above and below at the same time, as shown in Figure 32.

NOTE 3: if it is still hard to insert the infuser, leave it out of the machine, close the service door, unplug from the outlet then plug in again. Wait for all the lights to go off, then open the door and replace the infuser.

- replace the drip tray, complete with the grounds container;
- close the service door.

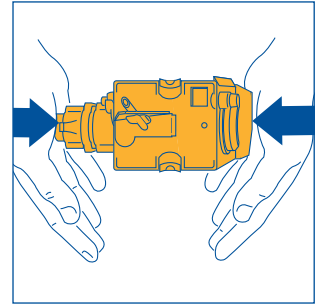

Fig.32

10.3 DESCALING

Due to the continuous heating of the water used to make the coffee, over time it is normal for the tubing inside the machine to fill with lime scale. When the ☉ ⏏ light starts flashing (section 12 - point 5), it is time to descale the machine.

NOTE: when the ☉ ⏏ light switches on, the coffee maker can still be used to prepare coffee.

Proceed as follows:



- Empty the tank and pour in the contents of one bottle (125 ml) of DUR-GOL descaler plus one liter of water. For subsequent descaling operations, descaling solution can be purchased from authorized technical service centers.

Note: Make sure splashes of descaler do not fall onto surfaces sensitive to acid such as marble, limestone and granite.

- place a container with a minimum capacity of 34 oz. under the cappuccino frother (Fig. 3);
- turn the machine on by pressing the ⓪ button (Fig. 4).
- wait for the green ☕ and ☕☕ indicator lights to come on steady.
- press and hold the ☉ ⏏ button for at least 5 seconds (Fig.14). The decalcification warning light will illuminate (section 11 - point 8) to indicate the start of the descaling program (the ☕ and ☕☕ lights remain off to indicate that it is not possible to make coffee).
- turn the steam knob half a turn counter-clockwise (Fig.5). The descaling solution will come out of the cappuccino frother and start to fill the container underneath.
- the descaling program automatically performs a series of deliveries and pauses, so as to remove the lime scale deposits from inside the coffee maker.

- after around 30 minutes, when the  light comes on (section 12 - point 1), turn the steam knob half a turn clockwise (Fig.6) until it stops.

The machine must be rinsed so as to eliminate the residues of descaling solution from inside the machine. Proceed as follows:











- remove the water tank, rinse it and fill it with clean water.
- reposition the tank.
- empty the collection container (located under the milk frother) that is full of liquid, and then replace it under the milk frother.
- turn the steam knob half a turn counter-clockwise (Fig. 5). Hot water will come out of the milk frother and fill the container underneath.
- when the tank is empty, the  light goes off and the  light comes on (section 12 - point 1).
- turn the steam knob all the way clockwise (Fig. 6) and fill the water tank with clean water again.
- the program of descaling is now terminated and the machine is ready to make coffee again.

NOTE: if the descaling procedure is interrupted before completion, the  alarm (section 12 - point 5) is not deactivated and the procedure must be started again from the beginning.







IMPORTANT: FAILURE TO DESCALE THE APPLIANCE REGULARLY INVALIDATES THE WARRANTY.

10.4 SETTING THE WATER HARDNESS

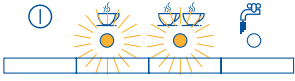
The  light (section 12 - point 5) switches on after after the machine has been operated for a factory set period of time calculated on the basis of the maximum quantity of lime scale which may be contained in the water used. If necessary, this period of operation can be extended, thus making the descaling operation less frequent, by programming the machine based on the actual lime content in the water used. Proceed as follows:

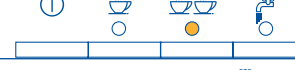
- after having removed the "Total hardness test" strip (enclosed on page 2) from its packaging, dip it fully in the water for a few seconds, then pull it out and wait around 30 seconds (until it changes color and a number of squares are formed);
- check that the machine is off (all the indicator lights are off);
- press the  button (Fig. 14) and hold it for at least 5 seconds. The four lights , ,  and  come on.
- press the  button (Fig.18) repeatedly until the number of lights that are on coincides with the number of red squares on the test strip (for example, if there are 3 red squares on the test strip, press the button  until 3 indicator lights come on together, ,  and ).
- press the  button (Fig. 14) to save the data. The coffee maker is now programmed to provide the descaling warning when effectively necessary, based on the actual hardness of the water.

11 MEANING OF THE NORMAL OPERATION INDICATOR LIGHTS

LIGHT	DESCRIPTION	MEANING
1 	<i>The ☕, ☕☕ indicator lights flash</i>	The machine is not ready to make coffee (the ideal water temperature has not yet been reached). Wait for the indicator lights to come on steady before making the coffee.
2 	<i>The ☕, ☕☕ indicator lights are on steady.</i>	The machine is at the right temperature and ready to make coffee.
3 	<i>The ☕ light is on steady</i>	The machine is delivering one cup of coffee.
4 	<i>The ☕☕ light is on steady</i>	The machine is delivering two cups of coffee.
5 	<i>The ☁ steam light flashes</i>	The machine is delivering steam.
6 	<i>The ☁ light is on steady</i>	The machine is ready to deliver hot water.
7 	<i>The ☞ light is on steady</i>	The machine is ready for espresso/coffee using ground coffee (see section 7).
8 	<i>The ☞ light is on steady</i>	The automatic descaling program is in progress (see section 10.3).

12 MEANING OF THE ALARM INDICATOR LIGHTS AND WHAT TO DO WHEN THEY ARE ON





	LIGHTS	DESCRIPTION	MEANING	ACTION
1		The light is on steady	The water tank is empty or is positioned incorrectly.	Fill the water tank as described in section 5, note 6 and insert it fully.
			The tank is dirty or lined with lime scale.	Rinse or descale the tank.
2		The light flashes	The machine cannot make the coffee and is noisy.	Turn the steam knob counter-clockwise (Fig. 5) as described in section 5 note 10.
			The coffee comes out too slowly.	Turn the grinding adjustment knob (Fig. 17) one click clockwise (section 6).
3		The light is on steady	The coffee grounds container is full or not in place.	Empty the grounds container and clean it as described in section 5 - note 7, then insert it fully.
			The grounds container has not been replaced after cleaning.	Open the access door and replace the grounds container.
4		The light flashes	The ground coffee has not been poured into the funnel with the function selected.	Add the ground coffee as described in par. 7.
			No more coffee beans	Fill the container with beans, as described in section 4.2
			If the coffee grinder is very noisy, it means that a small stone in the coffee beans has blocked the coffee grinder.	Contact an authorized De'Longhi service center.
5		The light flashes	This indicates the presence of lime scale in the machine.	The descaling procedure, described in section 10.3, needs to be performed as soon as possible.
6		The machine makes a strange noise and the four lights , , , and flash alternately.	After cleaning, the infuser has probably been left out of the coffee maker.	Leave the service door closed and the infuser out of the coffee maker. Press the 1 CUP and 2 CUPS buttons together until the four lights go off. Only when all four lights are off can the door be opened and the infuser inserted (to insert the infuser see section 10.2)
7		The and lights flash alternately	The machine has just been switched on and the infuser is not inserted correctly, consequently the service door is not closed properly.	Press the infuser where marked PUSH until hearing the click. Check that the two red buttons snap out correctly (section 10.2). Close the service door and press the button.
8		The , , and lights are on and flashing	The machine has been switched on with the steam knob in the open position.	Turn the steam knob clockwise all the way round (Fig. 6).
9		The light is flashing	The service door is open.	If the service door cannot be closed, check that the infuser is inserted correctly (section 10.2 - note 1).

	LIGHTS	DESCRIPTION	MEANING	ACTION
10		<p>The light is on steady and the green lights are flashing.</p>	After cleaning, the infuser has probably been left out of the coffee maker	Insert the infuser, see section 10.2
			The inside of the machine is very dirty.	Thoroughly clean the inside of the machine, as described in section 10.2
11		<p>The light is flashing</p>	The ground coffee funnel is clogged.	Empty the funnel with the help of a knife, as described in par. 7 note 5 (Fig.20).

13 PROBLEMS THAT CAN BE RESOLVED BEFORE CALLING THE SERVICE CENTER

If the machine is not working and an alarm light is on, the causes of the malfunction can be identified and resolved by referring to section 12. If, on the other hand, no alarm light is on, run the following checks before calling the service center.

PROBLEM	CAUSE	SOLUTION
<ul style="list-style-type: none"> The espresso / coffee is no hot. 	<ul style="list-style-type: none"> The cups have not been pre-heated. 	Heat the cups by rinsing them in hot water or leaving them to rest for at least 20 minutes on the cup warmer tray (see section 5 note 3).
	<ul style="list-style-type: none"> The infuser is too cold. 	Heat the infuser by pressing the button before making the coffee (Fig. 14, see note 3, section 5).
<ul style="list-style-type: none"> The coffee is not creamy enough 	<ul style="list-style-type: none"> The machine uses too little coffee during the infusion process. 	Turn the espresso/coffee flavor knob (Fig. 7) a little clockwise (see section 5 note 2)
	<ul style="list-style-type: none"> The coffee is ground too coarse. 	Turn the grinding coarseness regulator (Fig. 17) one click counter-clockwise (see section 6).
	<ul style="list-style-type: none"> The ground coffee is not correct 	Use another brand of coffee blend.
<ul style="list-style-type: none"> The coffee comes out too slowly 	<ul style="list-style-type: none"> The coffee is ground too fine. 	Turn the grinding adjustment knob (Fig. 17) one click clockwise (see chap. 6).
	<ul style="list-style-type: none"> The machine uses too much coffee during the infusion process. 	Turn the espresso/coffee flavor knob (Fig. 7) a little counter-clockwise.
<ul style="list-style-type: none"> The coffee comes out too quickly. 	<ul style="list-style-type: none"> The coffee is ground too coarse. 	Turn the grinding adjustment knob (Fig. 17) one click counter-clockwise (see section 6).
	<ul style="list-style-type: none"> The machine uses too little coffee during infusion. 	Turn the espresso/coffee flavor knob (Fig. 7) a little clockwise.

PROBLEM	CAUSE	SOLUTION
<ul style="list-style-type: none"> The coffee does not come out of one of the spouts. 	<ul style="list-style-type: none"> The spout is blocked. 	Scrape the remains of dry coffee accumulated with a needle (Fig. 28).
<ul style="list-style-type: none"> Turning the steam knob, no steam comes out of the milk frother. 	<ul style="list-style-type: none"> The holes in the spouts are clogged. 	Clean the holes in the milk frother and the steam nozzle (see section 9 - Fig.27).
<ul style="list-style-type: none"> Pressing the  and  buttons, the machine does not deliver coffee, but only water. 	<ul style="list-style-type: none"> Ground coffee may be blocked in the funnel. 	Remove the ground coffee inside the funnel, using a plastic knife (see section 7 – note 5). Then clean the infuser and the inside of the machine (see description in section 10.2).
<ul style="list-style-type: none"> Pressing the  button, the machine does not switch on. 	<ul style="list-style-type: none"> The machine is not plugged in. 	Check that the power cable is plugged into the power outlet.
<ul style="list-style-type: none"> The infuser cannot be removed for cleaning. 	<ul style="list-style-type: none"> The machine is on. The infuser can only be removed if the machine is off. 	Turn the machine off (see section 10.2). WARNING: the infuser can only be removed when the machine is off. Attempting to remove the infuser with the machine on will risk causing damage.
<ul style="list-style-type: none"> Ground coffee is used (rather than beans) and the machine does not deliver the coffee. 	<ul style="list-style-type: none"> Too much ground coffee has been added. 	Remove the infuser and thoroughly clean the inside of the machine, as described in section 10.2. Repeat the operation using a maximum of 1 level measure of ground coffee.
	<ul style="list-style-type: none"> The  button has not been pressed and the machine has used both the ground coffee added and the coffee ground by the grinder. 	Thoroughly clean the inside of the machine, as described in section 10.2. Repeat the operation by first pressing the  button, as indicated in section 7.
	<ul style="list-style-type: none"> Ground coffee has been added when the machine is off. 	Remove the infuser and thoroughly clean the inside of the machine, as described in section 10.2. Repeat the operation, however switching on the machine first.
<ul style="list-style-type: none"> The coffee does not come out of the spouts, but rather around the service door. 	<ul style="list-style-type: none"> The holes in the spouts are clogged with dry coffee. 	Scrape the holes with a needle (see section 10.1, Fig. 28).
	<ul style="list-style-type: none"> The mobile drawer inside the service door is blocked and cannot swing. 	Thoroughly clean the mobile drawer, particularly near the hinges to ensure they are free to swing smoothly.



This warranty applies to Super Automatic Espresso Machines with the De'Longhi brand name.

LIMITED WARRANTY

What does the warranty cover?

We warrant each appliance to be free from defects in material and workmanship. Our obligation under this warranty is limited to repair at our factory or authorized service center of any defective parts or part thereof, other than parts damaged in transit. The repaired or new model will be returned at the company expense.

This warranty shall apply only if the appliance is used in accordance with the factory directions, which accompany it, and on an alternating current (AC) circuit.

How long does the coverage last?

This warranty runs for two years (2) from the purchase date found on your receipt and applies only to the original purchaser for use.

What is not covered by the warranty?

The warranty does not cover defects or damage of the appliance, which result from repairs or alterations to the appliance outside our factory or authorized service centers, nor shall it apply to any appliance, which has been subject to abuse, misuse, negligence or accidents. Also, consequential and incidental damage resulting from the use of this product or arising out of any breach of contract or breach of this warranty are not recoverable under this warranty. Some states do not allow the exclusion or limitation of incidental or consequential damage, so the above limitation may not apply to you.

How do you get service?

If repairs become necessary, see contact information below:

U.S. Residents:

Please contact our toll free hotline at #1-866-Latte-Best or log onto our website at www.delonghi.com.

For all accessories, spare parts or replacement parts, please contact our parts division at 1-866-528-8323.

Residents of Canada:

Please contact our toll free hotline at #1-866-Latte-Best or 1-866-528-8323 (Hours of Operation: Monday - Friday 8:30am - 8pm, Saturday & Sunday 9:00am - 5:30pm) or log onto our website at www.delonghi.com.

Residents of Mexico:

Please refer to the Limited Warranty statement for Mexico (see page 60).

Please refer to the back page of the manual for De'Longhi addresses.

The above warranty is in lieu of all other express warranties and representations. All implied warranties are limited to the applicable warranty period set forth above. This limitation does not apply if you enter into an extended warranty with De'Longhi. Some states do not allow limitations on how long an implied warranty lasts, so the above exclusions may not apply to you. De'Longhi does not authorize any other person or company to assume for it any liability in connection with the sale or use of its appliance.

How does state law apply?

This warranty gives you specific legal rights, and you may also have other rights, which vary from state to state.