



Owner's Manual

Model Numbers:

TCS-3401

CHAINSAW

P/N 29356

Date 04-20-01

TCS-3401



Supplier To The Outdoor Power Equipment Industry

ISM, Inc. • 1028 4th Street SW • Auburn, WA 98001 • Phone: (253) 333-1200 • Fax: (253) 333-1212

Before using this unit:

- Read the operator's manual carefully.
- Check that the cutting equipment is correctly assembled and adjusted.
- Start the unit and check the carburetor adjustment. See "Maintenance".

⚠ WARNING

The engine exhaust from this product contains chemicals known to the State of California to cause cancer, birth defects and other reproductive harm.



Always wear eye, head and ear protectors when using this unit.

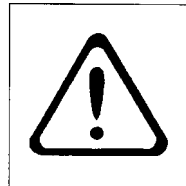

Read, understand and follow all warnings and instructions in this manual and on the unit.

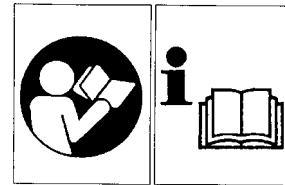

It is important that you read, fully understand and observe the following safety precautions and warnings. Careless or improper use of the unit may cause serious or fatal injury.



Warning, kickback danger. Be careful sudden and accidental upward and/or backward motion of the guide bar.

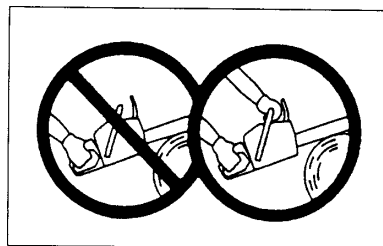

One-handed usage not permitted. While cutting, hold saw firmly with both hands with thumb firmly locked around front handle.

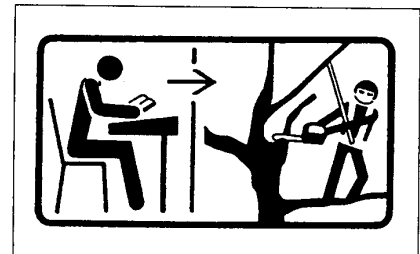

The saw is specially designed for tree service and therefore shall be used by trained operators only, in off-ground work in trees.

1. What is what?

(En) Since this manual covers several models, there may be some difference between pictures and your unit. Use the instructions that apply to your unit.

1. Throttle trigger
2. Safety trigger
3. Ignition switch
4. Oil tank cap
5. Recoil starter
6. Front handle
7. Fuel tank cap
8. Choke control knob
9. Priming pump
10. Guide bar
11. Saw chain
12. Front hand guard
13. Throttle lock
14. Chain brake
15. Spiked bumper (optional)
16. Chain catcher
17. Guide bar cover
18. Attachment point
19. Combi box spanner
20. Owner's manual

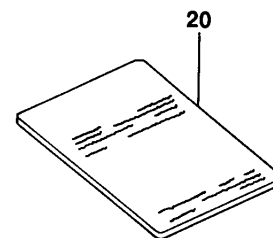
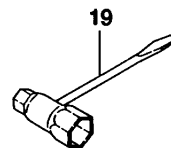
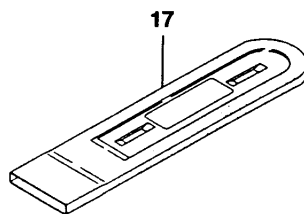
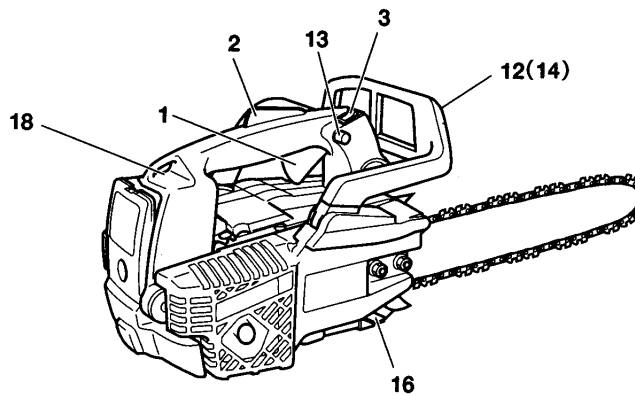
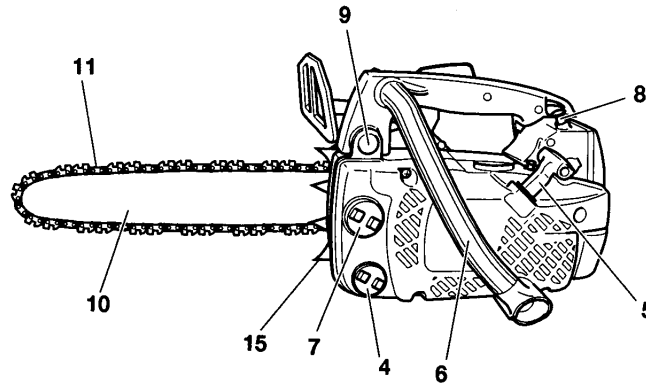

2. Warnings and safety instructions

Operator Safety



WARNING!

This chain saw is designed especially for tree care and surgery. Only persons trained in tree care and surgery may use this saw. Observe all literature, procedures and recommendations from the relevant professional organization. Failure to do so constitutes a high accident risk. We recommend always using a rising platform for sawing in trees. Repelling techniques are extremely dangerous and require special training. The operator must be trained in and familiar with the use of safety equipment and working and climbing techniques. Always use the restraining equipment for both the operator and the saw.

- Always wear a safety face shield or goggles.
- Gloves should be used when sharpening chain.
- Always wear safety protective equipment such as jacket, trousers, gloves, boots with steel toe-caps and non-slip soles whenever you use a chain saw. For working in trees the safety boots must be suitable for climbing techniques. Do not wear loose clothing, jewelry, short pants, sandals or go barefoot. Secure hair so it is above shoulder length.
- Do not operate that tool when you are tired, ill or under the influence of alcohol, drugs or medication.
- Never let a child or inexperienced person operate the machine.
- Wear hearing protection.
- Never start or run the engine inside a closed room or building. Breathing exhaust fumes can kill.
- Keep handles free of oil and fuel.
- Keep hands away from cutting equipment.
- Do not grab or hold the unit by the cutting equipment.
- When the unit is turned off, make sure the cutting attachment has stopped before the unit is set down.
- When operation is prolonged, take a break from time to time so that you may avoid possible whitefinger disease which is caused by vibration.
- The operator must obey the local regulations of cutting area.

Unit/Machine Safety

- Inspect the entire unit/machine before each use. Replace damaged parts. Check for fuel leaks and make sure all fasteners are in place and securely tightened.
- Replace parts that are cracked, chipped or damaged in any way before using the unit/machine.
- Make sure the safety guard is properly attached.
- Keep others away when making carburetor adjustments.
- Use only accessories as recommended for this unit/machine by the manufacturer.
- Never let the chain strike any obstacle.
- If the chain makes contact, the machine should be stopped and checked carefully.
- Make sure the automatic oiler is working.
- Keep the oil tank filled with clean oil. Never let chain run dry on the bar.
- All chainsaw service, other than the items listed in the operator's/owner's manual, should be performed by competent chainsaw service personnel. (For example, if improper tools are used to remove the flywheel or if an improper tool is used to hold the flywheel in order to remove the clutch, structural damage to the flywheel could occur and could subsequently cause the flywheel to burst.)



WARNING!

Never modify the unit/machine in any way.

Do not use your unit/machine for any job except that for which it is intended.



WARNING!

Never use chain saw without any safety equipment or that has faulty safety equipment. It could result in serious personal injury.



WARNING!

Using guide bar/chain other than recommended by the manufacturer which are not approved, could result in a high risk of personal accidents or injury.

Fuel Safety

- Mix and pour fuel outdoors and where there are no sparks or flames.
- Use a container approved for fuel.
- Do not smoke or allow smoking near fuel or the unit/machine or while using the unit/machine.
- Wipe up all fuel spills before starting engine.
- Move at least 3 m away from fueling site before starting engine.
- Stop engine before removing fuel cap.
- Empty the fuel tank before storing the unit/machine. It is recommended that the fuel be emptied after each use. If fuel is left in the tank, store so fuel will not leak.
- Store unit/machine and fuel in area where fuel vapors cannot reach sparks or open flames from water heaters, electric motors or switches, furnaces, etc.



WARNING!

Anti-vibration systems do not guarantee that you will not sustain whitefinger disease or carpal tunnel syndrome. Therefore, continual and regular users should monitor closely the condition of their hands and fingers. If any of the above symptoms appear, seek medical advice immediately.

Cutting Safety

- Do not cut any material other than wood or wooden objects.
- For respiratory protection, wear an aerosol protection mask when cutting the wood after insecticide has been applied.
- Keep others including children, animals, bystanders and helpers outside the hazard zone. Stop the engine immediately if you are approached.
- Hold the unit/machine firmly with both hands.
- Keep firm footing and balance. Do not over-reach.
- Keep all parts of your body away from the muffler and cutting attachment when the engine is running.
- Keep Bar/Chain below waist level.
- Before felling a tree, the operator must be accustomed to the sawing techniques of the chain saw.
- Be sure of pre-plan a safe exit from a falling tree.
- While cutting, hold saw firmly with both hands with thumb firmly locked around front handle, and stand with feet well balanced and your body balanced.
- Stand to the side of the saw when cutting never directly behind it.
- Always keep the spiked bumper face to a tree, because the chain may suddenly be drawn into a tree.
- Be alert against kickback (when saw kicks up and back at operator). Never cut with the nose of the bar.

Maintenance safety

- Maintain the unit/machine according to recommended procedures.
- Disconnect the spark plug before performing maintenance except for carburetor adjustments.
- Keep others away when making carburetor adjustments.
- Use only genuine Tanaka replacement parts as recommended by the manufacturer.



WARNING!

Improper maintenance could result in serious engine damage or in serious personal injury.

Transport and storage

- Carry the unit/machine by hand with the engine stopped and the muffler away from your body.
- Allow the engine to cool, empty the fuel tank, and secure the unit/machine before storing or transporting in a vehicle.
- Empty the fuel tank before storing the unit/machine. It is recommended that the fuel be emptied after each use. If fuel is left in the tank, store so fuel will not leak.
- Store unit/machine out of the reach of children.
- Clean the unit carefully and store it in a dry place.
- Make sure engine switch is off when transporting or storing.
- When transporting in a vehicle, cover chain with chain cover.

If situations occur which are not covered in this manual, take care and use good judgement.

Contact your dealer if you need assistance.

Pay special attention to statements preceded by the following words:



WARNING!

Indicates a strong possibility of severe personal injury or loss of life, if instructions are not followed.

CAUTION!

Indicates a possibility of personal injury or equipment damage, if instructions are not followed.

NOTE!

Helpful information for correct function and use.

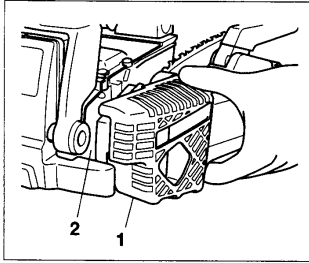

Fig. 1-1

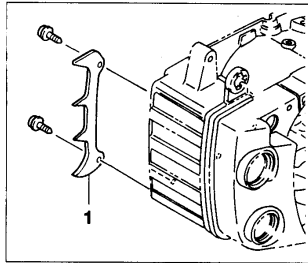

Fig. 1-1B

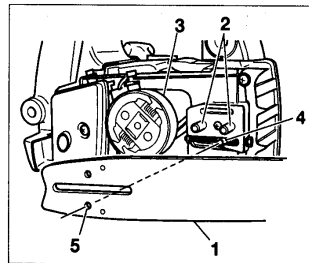

Fig. 1-2

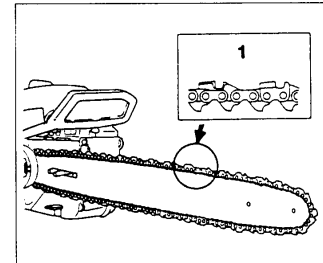

Fig. 1-3

3. Assembly procedures

⚠ WARNING!

Never try to start engine without side case securely fastened.

1. Remove chain bar clamp nuts.
2. Remove the side case (1) while pinching the rear part of the side case (1) .(Fig.1 -1)
Install the spiked bumper (1) (if so equipped) to the unit with the two screws. (Fig. 1 -1 B)
3. Install, the chain bar (1) onto the bolts (2), then push it toward the sprocket (3) as far as it will go. Make sure that the boss of chain tension adjust bolt (4) fits into the hole of the bar (5). (Fig. 1-2)

NOTE!

Slightly move the bar back and forth and make sure the chain tension boss (4) fits into the hole (5) in the bar properly.

4. Confirm the direction of saw chain (1) is correct as in the figure, and align the chain on the sprocket. (Fig. 1-3)
5. Guide the chain drive links into the bar groove all around the bar.
6. Install the side case (1) onto the guide bar clamp bolts after inserting it on the alignment/locking tab on the engine case (2). (Fig. 1 - 1)
Then fix the clamp nuts temporarily.

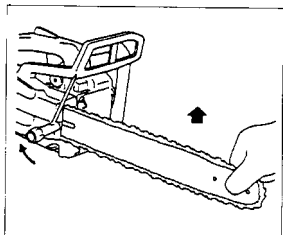

Fig. 1-4

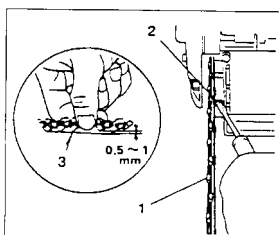

Fig. 1-5

7. Raise the bar end, and tighten the chain (1) by turning the tension adjustment bolt (2) clockwise. To check proper tension, lightly lift up the center of chain and there should be about 0.5-1.0 mm clearance between bar and edge of drive link (3). (Fig.1 -4, 5)

CAUTION!

- **PROPER TENSION IS EXTREMELY IMPORTANT!**

8. Raise the bar end and securely tighten the chain bar clamp nuts with the box wrench. (Fig. 1 -4)
9. A new chain will stretch so adjust the chain after a few cuts and watch chain tension carefully for the first half hour of cutting.

NOTE!

Check the chain tension frequently for optimum performance and durability.

CAUTION!

- When the chain is excessively tightened, the bar and chain will be damaged rapidly. Conversely, when the chain is excessively loosened, it may get out of the groove in the bar.
- Always wear gloves when touching the chain.

WARNING!

During operation, hold chain saw firmly with both hands. A single hand operation may cause serious injury.

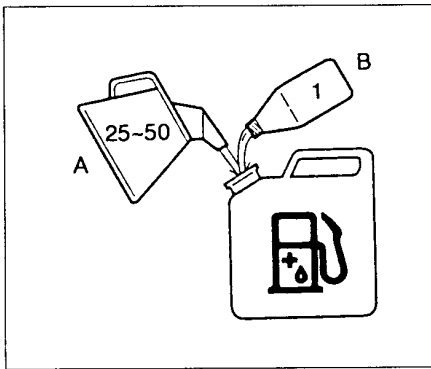

Fig. 2-1

4. Operating procedures

Fuel (Fig. 2-1)

⚠ WARNING!

The chainsaw is equipped with a two-stroke engine. Always run the engine on fuel, which is mixed with oil. Provide good ventilation, when fueling or handling fuel.

Fuel

- Always use branded 89 octane unleaded gasoline.
- Use Tanaka two-cycle oil or a quality two-cycle oil at mixing ratio of 25-50:1 (Gasoline (A) : Oil (B)), only for the state of California at 50:1.
- Never use multi-grade oil (10 W/30) or waste oil.
- Always mix fuel and oil in a separate clean container.
- Always start by filling half the amount of fuel, which is to be used. Then add the whole amount of oil. Mix (shake) the fuel mixture.
- Add the remaining amount of fuel.
- Mix (shake) the fuel-mix thoroughly before filling the fuel tank.

Fueling

⚠ WARNING!

- Always shut off the engine before refueling.
- Slowly open the fuel tank, when filling up with fuel, so that possible over-pressure disappears.
- Tighten the fuel cap carefully, after fueling.
- Always move the unit at least 3 m (10 ft.) from the fueling area before starting.

Before fueling, clean the tank cap area carefully, to ensure that no dirt falls into the tank. Make sure that the fuel is well mixed by shaking the container, before fueling.

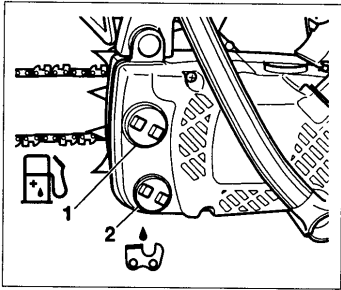

Fig. 2-1B

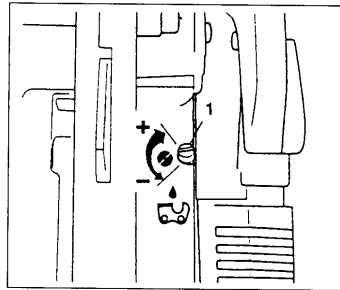

Fig. 2-1C

CHAIN OIL (Fig. 2-1 B)

Fill chain oil reservoir (2). Always use good quality chain oil. When the engine is running, the chain oil is automatically discharged.

NOTE!

When pouring fuel (1) or chain oil (2) into the tank, place the unit with cap side up.

ADJUSTMENT OF CHAIN OIL SUPPLY

The chain oil quantity discharged through the lubrication system is factory-adjusted to the maximum. Adjust the quantity in accordance with the operating condition.

Turn the adjusting screw (1) counterclockwise to decrease the quantity and turn it clockwise to increase the quantity. (Fig. 2-1 C)

Do not try to turn the screw beyond level marks.

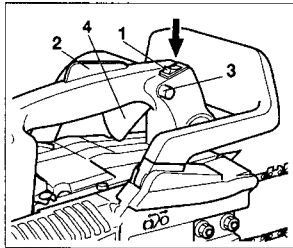

Fig. 2-2

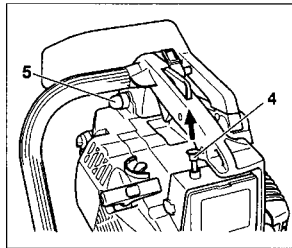

Fig. 2-3

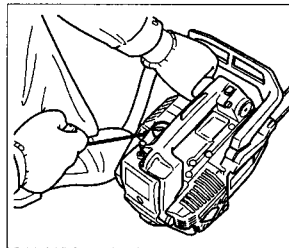

Fig. 2-4

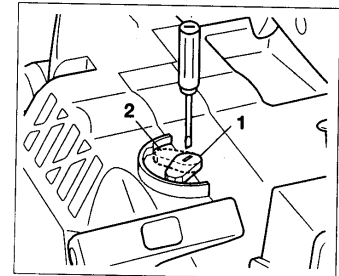

Fig. 2-4B

Starting (Fig. 2-2, 3)

⚠ WARNING!

When the engine starts with the throttle lock engaged, the engine speed is high enough to make the chain rotate.

CAUTION!

Before starting, make sure chain brake is disengaged (if so equipped) and that the Bar/chain does not touch anything.

1. Set ignition switch (1) to ON position.

*Push priming bulb (5) several times so that fuel flows through bulb into carburetor. (if so equipped)(Fig. 2-3)

2. With the safety trigger (2) pressed pull throttle trigger (4) and push throttle lock (3), then slowly release the throttle trigger first, then the safety trigger. This will lock the throttle in starting position. (Fig. 2-2)

3. Pull choke knob to choked position (4). (Fig. 2-3)

4. Pull recoil starter briskly, taking care to keep the handle in your grasp and not allowing it to snap back. (Fig.2-4)

5. When you hear the engine want to start, return choke knob to run position. Then pull recoil starter briskly again.

NOTE!

If engine does not start, repeat procedures from 2 to 5.

6. After starting engine, pull throttle trigger to release throttle lock. Then allow the engine about 2-3 minutes to warm up before subjecting it to any load.

NOTE! Icing protection system (Fig.2-4B)

When you use the unit in winter time or cold weather, move the lever forward (2) to protect carburetor from icing, otherwise just leave it in its regular position (1).

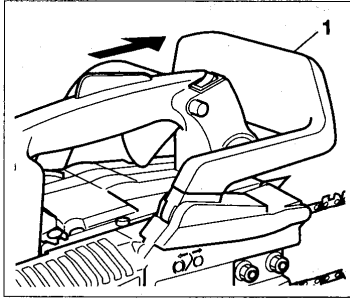

Fig. 2-5

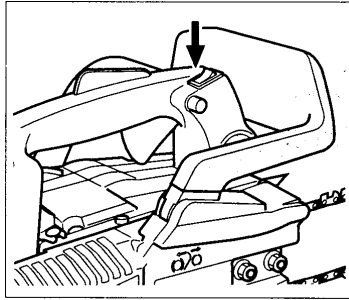

Fig. 2-6

Chain brake operation (Fig. 2-5)

Chain brake (1) is designed to activate in an emergency such as kick-back action. Please check to verify that it works properly before use.

Application of brake is made by moving the front guard towards the bar. During the chain brake operation, even if the throttle lever is pulled, the engine speed does not increase and the chain does not turn. To release the brake, pull up the chain brake lever.

⚠ WARNING!

Do not carry the machine with the engine running.

Stopping (Fig. 2-6)

Decrease engine speed, and push ignition switch to stop position.

⚠ WARNING! KICKBACK DANGER (Fig. 2-7)

One of the most severe dangers when working with a chain saw is the possibility of kickback.

Kickback may occur when the upper tip of the guide bar touches an object, or when the wood closes in and pinches the saw chain in the cut. Tip contact in some cases may cause a lightning fast reverse reaction, kicking the guide bar up and back toward you. Pinching the saw chain along the top of the guide bar may also push the guide bar rapidly back towards you. Either of these reactions may cause you to lose control of the saw which could result in serious personal injury.

Even though your saw has safety built into its design, you should not rely on these safety features exclusively.

Know where your bar tip is at all times.

Kickback does occur if you allow the kickback zone (1) of the bar to touch an object. Do not use that area. Kickback from pinching is caused by a cut closing and pinching the upper side of the guide bar. Study your cut and make sure it will open as you cut through.

Maintain control when the engine is running by always keeping a firm grip on the saw with your right hand on the rear handle, your left hand on the front handle and your thumbs and fingers encircling the handles. Always hold the saw with both hands during operation and cut at high engine speed.

⚠ WARNING!

Do not overreach or cut above shoulder height.

⚠ WARNING!

Use extra caution when felling, and do not use the saw in a nose-high position or above shoulder height.

CHAIN CATCHER

The chain catcher is located on the power head just below the chain to further prevent the possibility of a broken chain striking the chainsaw user.

⚠ WARNING!

Do not stand in-line with chain when cutting.

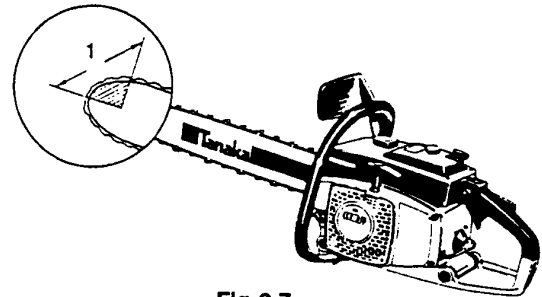

Fig. 2-7

BASIC TECHNIQUES FOR MAKING FELLING, LIMBING AND BUCKING CUTS

The intention of the following information is to provide you with the general introduction to wood cutting techniques.

⚠ WARNING!

This information does not cover all specific situations, which may depend on differences in terrain, vegetation, kind of wood, form and size of trees, etc. Consult your servicing dealer, forestry agent or local forestry schools for advise on specific woodcutting problems in your area. This will make your work more efficient and safer.

⚠ WARNING!

Avoid cutting in adverse weather conditions, such as dense fog, heavy rain, bitter cold, high winds, etc. Adverse weather is often tiring to work in and creates potentially dangerous conditions such as slippery ground. High winds may force the tree to fall in an unexpected direction causing property damage or personal injury.

⚠ CAUTION!

Never use a chainsaw to pry or for any purpose for which it is not intended.

⚠ WARNING!

Avoid stumbling on obstacles such as stumps, roots, rocks, branches and fallen trees. Watch out for holes and ditches. Be extremely cautious when working on slopes or uneven ground. Shut off the saw when moving from one work place to another. Always cut at wide open throttle. A slow moving chain can easily catch and force the saw to jerk. You should ask for help if you get into a cutting situation that seems difficult to you.

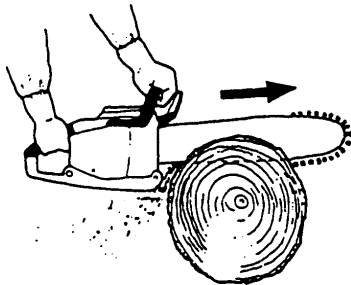

Fig. 2-7B

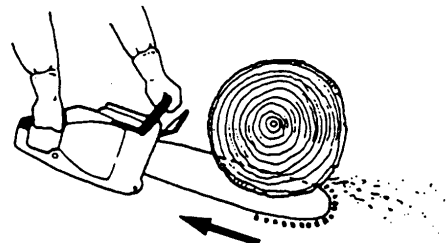

Fig. 2-7C

⚠ WARNING!

Never use the saw with only one hand. You cannot control the saw properly and you may lose control and injure yourself severely.

Keep the saw body close to your body to improve control and reduce strain.

When cutting with the bottom part of the chain the reactive force will pull the saw away from you towards the wood you are cutting.

The saw will control the feeding speed and sawdust will be directed towards you. (Fig. 2-7B)

When cutting with the upper part of the chain the reactive force will push the saw towards you and away from the wood you are cutting. (Fig. 2-7C)

⚠ WARNING!

There is a risk of kickback if the saw is pushed far enough so that you begin to cut with the nose of the bar.

The safest cutting method is to cut with the bottom part of the chain. Sawing with the upper part makes it much more difficult to control the saw and increases the risk of kickback.

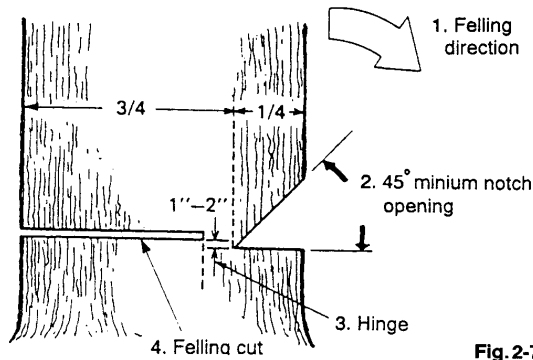

Fig. 2-7D

FELLING

Felling is more than cutting down a tree. You must also bring it down as near to an intended place as possible without damaging the tree or anything else.

Before felling a tree, carefully consider all conditions which may effect the intended direction, such as:

Angle of the tree. Shape of the crown. Snow load on the crown. Wind conditions. Obstacles within tree range (e.g., other trees, power lines, roads, buildings, etc.).

⚠ WARNING!

Always observe the general conditions of the tree. Look for decay and rot in the trunk which will make it more likely to snap and start to fall before you expect it.

Look for dry branches, which may break and hit you when you are working.

Always keep animals and people at least twice the tree length away while felling.

Clear away shrubs and branches from around the tree.

Prepare a path of retreat away from the felling direction.

BASIC RULES FOR FELLING TREES

Normally the felling consists of two main cutting operations-notching and making the felling cut.

Start making the upper notch cut on the side of the tree facing the feeling direction. Look through the kerf as you saw the lower cut so you do not saw too deep into the trunk.

The notch should be deep enough to create a hinge of sufficient width and strength.

The notch opening should be wide enough to direct the fall of the tree as long as possible.

Saw the felling cut from the other side of the tree between one and two inches (3-5 cm) above the edge of the notch. (Fig. 2-7D)

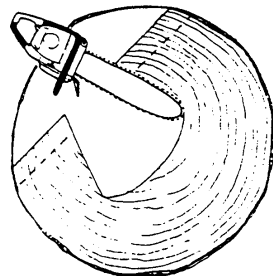

Fig. 2-7E

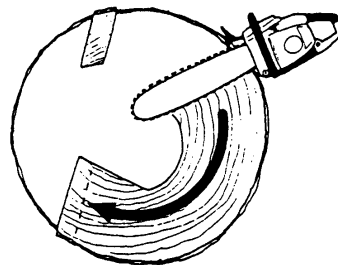

Fig. 2-7F

Never saw completely through the trunk. Always leave a hinge.

The hinge guides the tree. If the trunk is completely cut through, you lose control over the felling direction.

Insert a wedge or a felling lever in the cut well before the tree becomes unstable and starts to move. This will prevent the guide bar from binding in the felling cut if you have misjudged the falling direction. Make sure no people have come into the range of the falling tree before you push it over,

FELLING CUT, TRUNK DIAMETER MORE THAN TWICE GUIDE BAR LENGTH

Cut a large, wide notch. Then cut a recess into the center of the notch. Always leave a hinge on both sides of the center cut. (Fig. 2-7E)

Complete the felling cut by sawing around the trunk as in the Fig. 2-7F.

⚠ WARNING!

These methods are extremely dangerous because they involve the use of the nose of guide bar and can result in kickback. Only properly trained professionals should attempt these techniques.

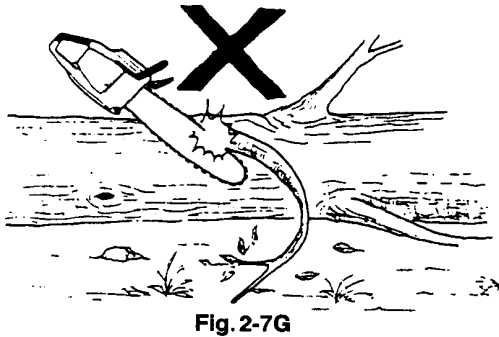

Fig. 2-7G

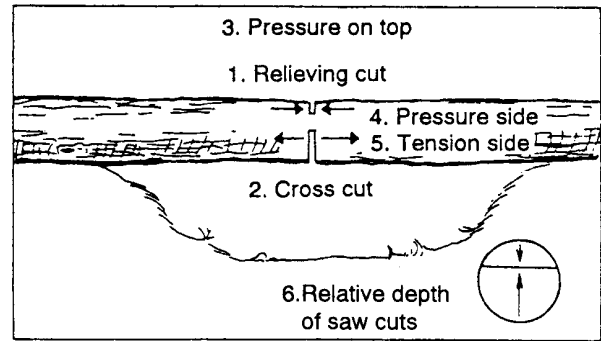

Fig. 2-7H

LIMBING

Limbing is removing the branches from a felled tree.

⚠ WARNING!

A majority of kickback accidents occur during limbing.

Do not use the nose of the guide bar. Be extremely cautious and avoid contacting the log, other limbs or objects with the nose of the guide bar. Be extremely cautious of limbs under tension. They can spring back towards you and cause loss of control resulting in injury. (Fig. 2-7G)

Stand on the left side of the trunk. Maintain a secure footing and rest the saw on the trunk.

Hold the saw close to you so that you are in full control of it. Keep well away from the chain.

Move only when the trunk is between you and the chain. Watch out for spring back of limbs under tension.

LIMBING THICK BRANCHES

When limbing thick branches, the guide bar may get pinched easily. Branches under tension often snap up, so cut troublesome branches in small steps. Apply the same principles as for cross cutting.

Think ahead and be aware of the possible consequences of all your actions.

CROSS CUTTING/BUCKING

Before starting to cut through the log, try to imagine what is going to happen. Look out for stresses in the log and cut through it in such a manner that the guide bar will not get pinched.

CROSS CUTTING LOGS, PRESSURE ON TOP

Take a firm stance. Begin with an upper cut.

Do not cut too deeply-about 1/3 of the log diameter is enough.

Finish with a bottom cut. The saw cuts should meet. (Fig. 2-7H)

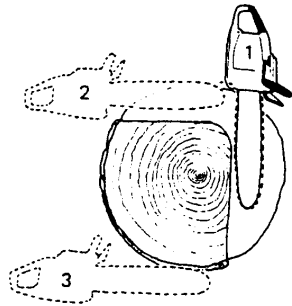

Fig. 2-7J

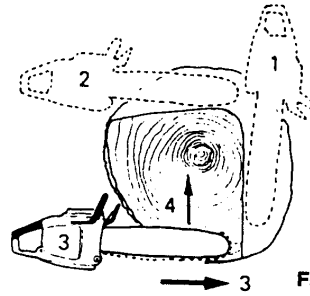

Fig. 2-7K

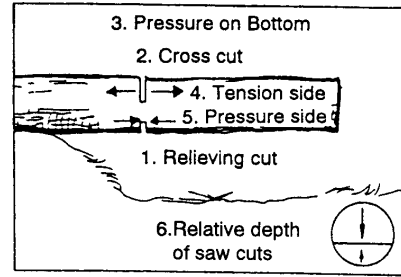

Fig. 2-7L

THICK LOG, LARGER THAN GUIDE BAR LENGTH

Begin by cutting on the opposite side of the log. Pull the saw towards you followed previous procedure. (Fig. 2-7J)

If the log is lying on the ground make a boring cut to avoid cutting into the ground. Finish with a bottom cut. (Fig. 2-7K)

⚠ WARNING! KICKBACK DANGER !!

Do not attempt a boring cut if you are not properly trained. A boring cut involves the use of the nose of the guide bar and can result in kickback.

CROSS CUTTING LOGS, PRESSURE ON BOTTOM

Take a firm stance. Begin with a bottom cut. The depth of the cut should be about 1/3 of the log diameter.

Finish with an upper cut. The saw cuts should meet. (Fig. 2-7L)

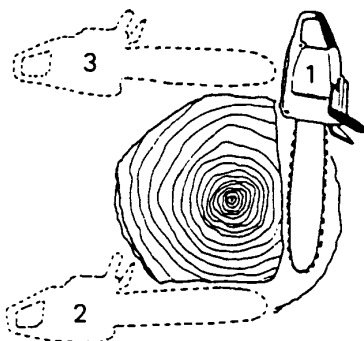

Fig. 2-7M

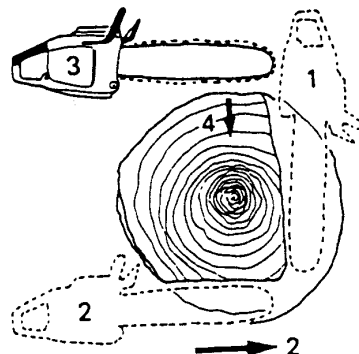

Fig. 2-7N

THICK LOG, LARGER THAN GUIDE BARS LENGTH

Begin by cutting on the opposite side of the log. Pull the saw towards you, followed by previous procedure.

Make a boring cut if the log is close to the ground.

Finish with a top cut. (Fig. 2-7M)

⚠ WARNING! KICKBACK DANGER !!

Do not attempt a boring cut if you are not properly trained. A boring cut involves the use of the nose of the guide bar and can result in kickback. (Fig. 2-7N)

IF THE SAW GETS STUCK

Stop the engine.

Raise the log or change its position, using a thick branch or pole as a lever.

Do not try to pull the saw free. If you do, you can deform the handle or be injured by the saw chain if the saw is suddenly released.

5. Maintenance

MAINTENANCE, REPLACEMENT, OR REPAIR OF THE EMISSION CONTROL DEVICES AND SYSTEMS MAY BE PERFORMED BY ANY NONROAD ENGINE REPAIR ESTABLISHMENT OR INDIVIDUAL.

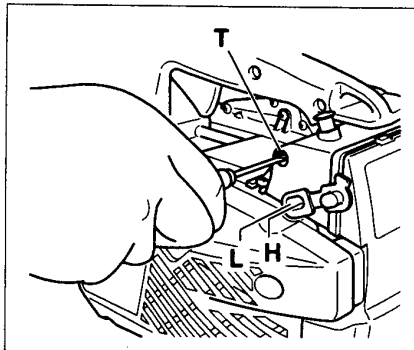

Fig. 3-1

Carburetor adjustment (Fig. 3-1)

⚠ WARNING!

Never start the engine without the complete clutch cover. Otherwise the clutch can come loose and cause personal injuries.

In the carburetor, fuel is mixed with air. When the engine is test run at the factory, the carburetor is basically adjusted. A further adjustment may be required, according to climate and altitude. The carburetor has one adjustment possibility:

T = Idle speed adjustment screw.

Idle speed adjustment (T)

Check that the air filter is clean. When the idle speed is correct, the cutting attachment will not rotate. If adjustment is required, close (clockwise) the T-screw, with the engine running, until the cutting attachment starts to rotate. Open (counter-clockwise) the screw until the cutting attachment stops. You have reached the correct idle speed when the engine runs smoothly in all positions well below the rpm when the cutting attachment starts to rotate.

If the cutting attachment still rotates after idle speed adjustment, contact your service workshop.

NOTE!

The L and H screws should only be adjusted by an Authorized Tanaka Dealer.

The standard openings (returns) of L/H screws from lightly seated positions are as follows:

Idle speed (min ⁻¹)	2800
L-SCREW ↻	1 ³ / ₈
H-SCREW ↻	1 ³ / ₈

⚠ WARNING!

When the engine is idling the cutting attachment must under no circumstances rotate.

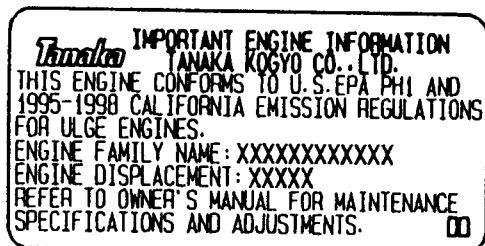

Fig. 3-1B

NOTE FOR THE US MARKET!! (Fig. 3-1C)

We would like to inform that the machines, which carry the following label on the unit are different from ones for other market in carburetor adjustment. Adjustment of Standard openings of L/H screws are not necessary. They are preset and fixed. Do not turn L/H screw fully but 90 degrees at most.

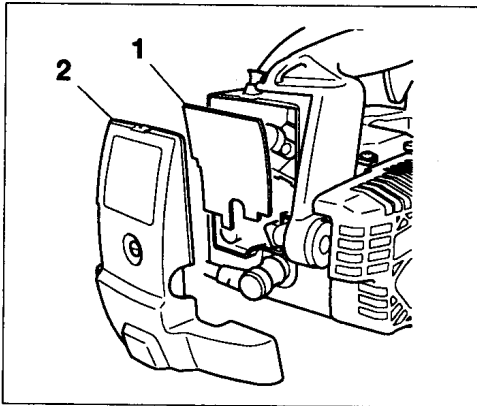

Fig. 3-2

Air filter (Fig. 3-2)

The air filter must be cleaned from dust and dirt in order to avoid:

- Carburetor malfunctions.
- Starting problems.
- Engine power reduction.
- Unnecessary wear on the engine parts.
- Abnormal fuel consumption.

Clean the air filter daily or more often if working in exceptionally dusty areas.

Cleaning the air filter

Remove the air filter cover and the filter (1). Rinse it in warm soap suds. Check that the filter is dry before reassembly. An air filter that has been used for some time cannot be cleaned completely. Therefore, it must regularly be replaced with a new one. A damaged filter must always be replaced.

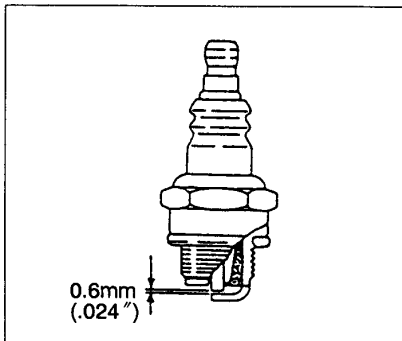

Fig. 3-3

Spark plug (Fig. 3-3)

The spark plug condition is influenced by:

- An incorrect carburetor setting.
- Wrong fuel mixture (too much oil in the gasoline)
- A dirty air filter.
- Hard running conditions (such as cold weather).

These factors cause deposits on the spark plug electrodes, which may result in malfunction and starting difficulties. If the engine is low on power, difficult to start or runs poorly at idling speed, always check the spark plug first. If the spark plug is dirty, clean it and check the electrode gap. Readjust if necessary. The correct gap is 0.6mm (.024"). The spark plug should be replaced after about 100 operation hours or earlier if the electrodes are badly eroded.

NOTE!

In some areas, local law requires using a resistor spark plug to suppress ignition signals. If this machine was originally equipped with resistor spark plug, use same type of spark plug for replacement.

Oiler port (Fig. 3-4)

Clean the chain Oiler port (1) whenever possible.

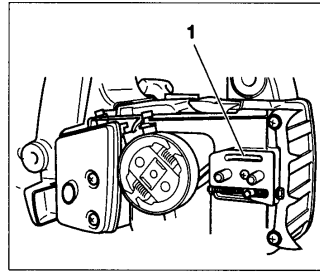

Fig. 3-4

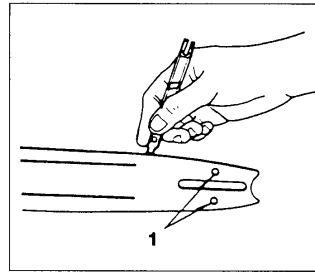

Fig. 3-5

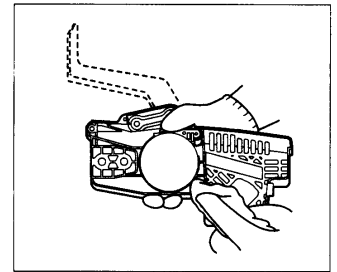

Fig. 3-6

Guide bar (Fig. 3-5)

Before using the machine, clean the groove and oiler port (1) in the bar with the special gauge offered as an optional accessory.

Side case (Fig. 3-6)

Always keep the side case and drive area clean of saw dust and debris.

Periodically apply oil or grease to this area to protect from corrosion as some trees contain high levels of acid.

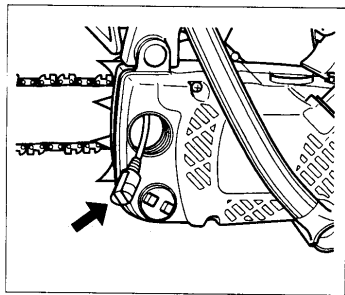

Fig. 3-7

Fuel filter (Fig. 3-7)

Remove the fuel filter from the fuel tank and thoroughly wash it in solvent. After that, push the filter into the tank

NOTE!

If the filter is hard due to dust and dirt, replace it.

Chain oil filter (Fig. 3-8)

Remove the oil filter and thoroughly wash it in solvent

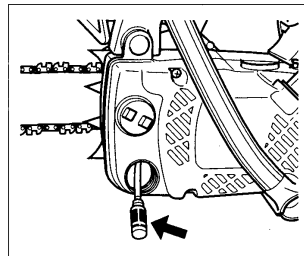

Fig. 3-8

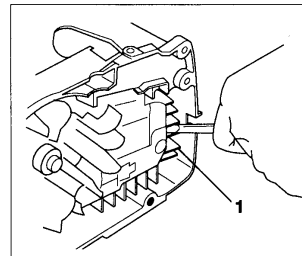

Fig. 3-9

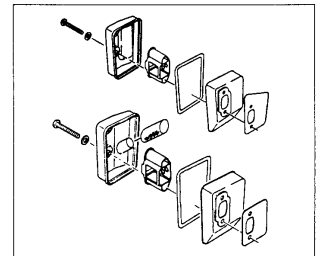

Fig. 3-10

Cleaning the cylinder fins (Fig. 3-9)

When wood chips are caught between cylinder fins (1), the engine may overheat, resulting in lower output. To avoid this, always keep cylinder fins and fan case clean.

Every 100 Operating hours, or once a year (more often if conditions require), clean fins and external surfaces of engine of dust, dirt and oil deposits which can contribute to improper cooling.

Cleaning the muffer (Fig. 3-10)

Remove the muffer and spark arrestor (if so equipped), and clean out any excess carbon from the exhaust port or muffer inlet every 100 hours of operation.

For long-term storage

Drain all fuel from the fuel tank. Start and let engine run until it stops. Repair any damage which has resulted from use. Clean the unit with a clean rag, or the use of high pressure air hose. Put a few drops of two-cycle engine oil into the cylinder through the spark plug hole, and spin the engine over several times to distribute oil. Cover the unit and store it in a dry area.

CHAIN SHARPENING

Parts of a cutter. (Fig. 4-1, 2)

⚠ WARNING!

Gloves should be used when sharpening chain.

1. Top plate
2. Working corner
3. Side plate
4. Gullet
5. Heel
6. Chassis
7. Rivet hole
8. Toe
9. Depth gauge
10. Correct angle on top plate (degree of angle depends on chain type)
11. Slightly protruding "hook" or point (curve on non-chisel chain)
12. Top of depth gauge at correct height below top plate
13. Front of depth gauge rounded off

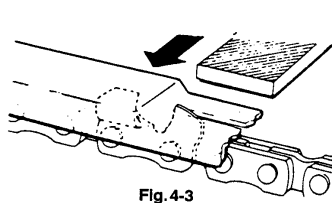
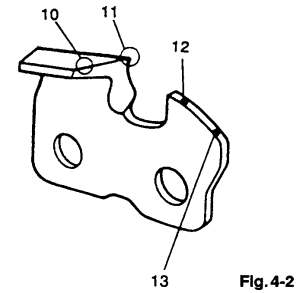
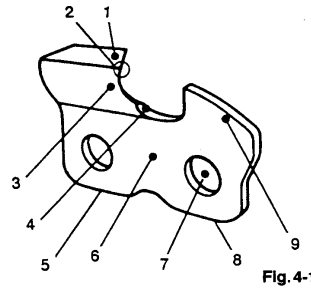

Fig. 4-3

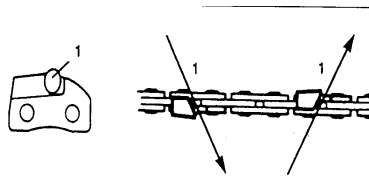

Fig. 4-5

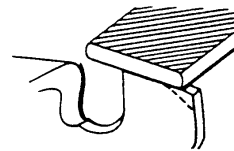

Fig. 4-4

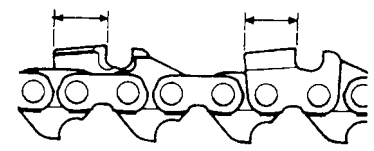

Fig. 4-6

LOWERING DEPTH GAUGES WITH A FILE

- 1) If you sharpen your cutters with a file holder, check and lower the depth.
- 2) Check depth gauges every third sharpening.
- 3) Place depth gauge tool on cutter. If depth gauge projects, file it level with the top of the tool. Always file from the inside of the chain toward an outside cutter. (Fig. 4-3)
- 4) Round off front corner to maintain original shape of depth gauge after using depth gauge tool. Always follow the recommended depth gauge setting found in the maintenance or operator manual for your saw. (Fig. 4-4)

GENERAL INSTRUCTIONS FOR FILING CUTTERS

File (1) cutter on one side of the chain from the inside out.

File on forward stroke only. (Fig. 4-5)

5) Keep all cutters the same length. (Fig. 4-6)

6) File enough to remove any damage to (~) 6 cutting edges (side plate (1) and top plate (2)) of cutter. (Fig. 4-7)

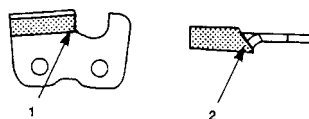

Fig. 4-7

SHARPENING ANGLES FOR SHARPENING SAW CHAIN (Fig. 4-7B)





1. Part Number	91VG
2. Pitch	3/8"
 3. Depth Gauge Setting	0.025"
 4. Side Plate Filing Angle	85°
 5. Top Plate Angle	30°
 6. File Guide Angle	90°

Fig. 4-7B

Maintenance schedule

Below you will find some general maintenance instructions.
For further information please contact your service dealer.

Daily maintenance

- Clean the exterior of the unit.
- Clean the chain oil filter port.
- Clean the groove and oil filter port in the guide bar
- Clean the side case of saw dust.
- Check that the saw chain is sharp.
- Check that the bar nuts are sufficiently tightened.
- Make sure that the chain transport guard is undamaged and that it can be securely fitted.
- Check that nuts and screws are sufficiently tightened.

Weekly maintenance

- Check the starter, especially cord and return spring.
- Clean the exterior of the spark plug,
- Remove the spark plug and check the electrode gap. Adjust it to 0.6 mm (.024'), or change the spark plug.
- Clean the cooling fins on the cylinder and check that the air intake at the starter is not clogged.
- Clean the air filter.











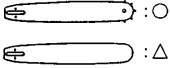

Monthly maintenance

- Rinse the fuel tank with gasoline, and clean fuel filter.
- Clean chain oil filter.
- Clean the exterior of the carburetor and the space around it.
- Clean the muffler of carbon.

6. Specifications

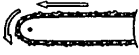
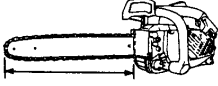
En MODEL

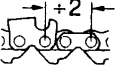
TCS-3401

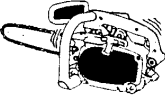
 Engine Size (ml) 34	 rpm MAX Max engine speed (min ⁻¹) 11,500
 Spark Plug Champion CJ8 or RCJ8	 rpm MIN Idle engine speed (min ⁻¹) 2,800
 Fuel Tank Capacity (l) 0.3	 Type of guide bar ○
 Chain Oil Tank Capacity (l) 0.19	 Type of chain 91VG (Oregon)
 Dry Weight (kg) 3.6 (Without guide bar and chain)	 Max chain speed (m/sec) 21.9
 Guide bar length (cm) 30-35 (12" - 14")	 Sprocket (number of teeth) 6
 Chain pitch (mm) 9.52 (3/8 inch)	
 Chain gauge (mm) 1.27 (0.05 inch)	
 Sound pressure level (dB(A)) by ISO7182 97.0	
Sound power level (dB(A)) by ISO/DIS9207 106.7	
 Vibration level (m/s ²) by ISO7505 Front handle 7.4 Rear handle 9.0	

Declaration of conformity
Declaration de conformité
Dichiarazione di conformità
Konformitätserklärung
Declaración de conformidad
Konformitetsdeklaration

We, Tanaka Kogyo Co., Ltd., 3-4-29 Tsudanuma, Narashino, Chiba, Japan
 Nous, soussignés,
 Noi,
 Der unterzeichnete,
 Nosotros,
 Vi,

TCS-3401

Declare under our sole responsibility that the product, chain saw model
 Déclarons sous notre seule responsabilité que le produit en question, tondeuse de gazon modèle
 Dichiariamo sotto la nostra unica responsabilità che il prodotto, il bordatore modello
 Erklärt unter, eigener Verantwortung, daß das Produkt, Rasenmäher Modell
 Declaramos bajo nuestra única responsabilidad que el producto, cortacésped modelo
 Förklarar härmed på eget ansvar att denna produkt, grasklippare modell

to which this declaration relates is in conformity with the essential safety requirements of directives.
 laquelle se rapporte la présente déclaration est conforme aux directives concernant les conditions de sécurité
 essentielles.
 al quale questa dichiarazione si riferisce, ~ conforme ai requisiti di sicurezza essenziali delle direttive.
 für das diese Erklärung gilt, den wesentlichen Sicherheitsanforderungen der Directive entspricht.
 que corresponde a esta declaración, satisface la (s) siguiente (s) exigencia (s) de seguridad esencial (es) de las
 directivas.
 till vilken denna deklARATION tillhör, uppfyller samtliga väsentliga säkerhetskrav föreskrivna i berörda direktiv.

98/37/EC, 89/336/EEC

The following standards have been taken into consideration EN 608, EN292-1, EN292-2
CISPR 12, EN ISO 11681-2
 Les normes suivantes ont été prises en considération. Sono
 stati presi in considerazione i seguenti standard. Die
 nachfolgenden Standards wurden in Betracht gezogen. Se
 han tenido en consideración las siguientes normas. Vi har
 tagit hänsyn till följande standarder.

Manufactured at:	Chiba, Japan	Serial No. up from	U001001
Fait A:		No. de série A partir de	
Luogo:		Num. di serie da	
Erstellt in:		Serien-Nr. ab	
Fabricado en:		No. de Serie de	
Tillverkad av:		Serienr. fr.o.m.	en adelante

Signature:
 Signature:
 Firma: Seiji Tanaka
 Unterschrift:
 Fimado:
 Signatur:



Position: Vice president
 Function: Vice-president
 Incarico: Vicepresidente
 Titel: Stellvertretender Vorsitzender
 Cargo: Vicepresidente
 Befattning: Vice President

IMPORTANT NOTICE

THIS INFORMATION IS FOR THE US AND CANADIAN MARKETS ONLY.

Only use replacement bars and chains specified by the manufacturer other equivalent.(See the chart below)

**Bar & Chain USA and Bar & Chain CANADA
LOW KICKBACK BAR AND CHAIN COMBINATIONS FOR USA**

Low-Kickback saw chain is chain which has met the kickback performance requirements of ANSI B1 75.1 -199 1. (American National Standard for Power Tools-Gasoline Powered Chain Saws-Safety Requirements) when tested on the representative sample of chain saws below 3.8 c.i.d. specified in ANSI B175.1-1991.

⚠ WARNING!

Use of other non-listed Bar/Chain combinations may increase kickback forces and increase the risk of kickback injury.

To reduce the possibility of kickback, it is important to use the correct bar and chain combinations. Following is a list of recommended combinations for Tanaka saws, TCS-3401. These powerhead, bar and chain combinations have been investigated in accordance with the ANSI B1 75.1-1991 standards.

MODEL NUMBER	BAR NUMBER	LENGTH-TYPE	CHAIN NUMBER
TCS-3401	120SDEA041	12"-DG	91VG045X
	140SDEA041	14"-DG	91VG052X

DG-DOUBLE GUARD™(is registered trademark of OMARK industries) ... Reversible reduced kickback-bar.