

Sunbeam

Sunbeam Brushed Remote Control Tower Fan

Instruction Booklet

FA7500 120cm Brushed Remote Control Tower Fan

Please read these instructions carefully
and retain for future reference.



Contents

Sunbeam's Safety Precautions	1
Safety Precautions For Your Tower Fan	2
Locating Your Tower Fan	3
Features Of Your Sunbeam Tower Fan	4
Assembling Your Tower Fan	6
Using Your Tower Fan	8
Troubleshooting Guide	12
Care And Cleaning	12

تأكد من تفهم احتياطات السلامة المذكورة اعلاه

請務必理解上述的安全預防措施。

Assurez-vous que les précautions ci-dessus relatives à la sécurité sont bien comprises

Versichern Sie sich daß die obenstehenden Sicherheitsmaßnahmen Verstanden werden

Βεβαιώνετε πως οι παραπάνω προφυλάξεις ασφαλείας γίνονται κατανοητές

Pastikan bahwa tindakan-tindakan keselamatan seperti di atas dimengerti anda

Accertatevi che le suddette norme di sicurezza siano comprese a dovere

上記の注意事項をよくお読みになり、安全を御確認ください

Уверете се дека погоре споменатите мерки на претпазливост се добро разбрани

Asegúrese de que las precauciones de seguridad precedentes sean bien comprendidas

کاری بکنید کہ احتیاطهای بالا حتماً درك بشوند

ต้องแน่ใจว่า ข้อควรระวังเรื่องความปลอดภัยข้างต้น เป็นที่เข้าใจกันดี

Yukarda belirtilen güvenlik önlemlerinin anlaşıldığından emin olunuz

Xin kiểm chắc rằng những biện pháp làm an toàn kể trên được hiểu rõ

Sunbeam's Safety Precautions

Sunbeam are very safety conscious when designing and manufacturing consumer products, but it is essential that the product user also exercise care when using an electrical appliance. Listed below are precautions which are essential for the safe use of an electrical appliance:

- Read carefully and save all the instructions provided with an appliance.
- Always turn the power off at the power outlet before you insert or remove a plug. Remove by grasping the plug - do not pull on the cord.
- Turn the power off and remove the plug when the appliance is not in use and before cleaning.
- Do not use your appliance with an extension cord unless this cord has been checked and tested by a qualified technician or service person.
- Always use your appliance from a power outlet of the voltage (A.C. only) marked on the appliance.
- Close supervision is necessary when your appliance is being used near children or infirm persons.
- This appliance is not intended for use by persons (including children) with reduced physical, sensory or mental capabilities, or lack of experience and knowledge, unless they have been given supervision or instruction concerning use of the appliance by a person responsible for their safety.
- Young children should be supervised to ensure that they do not play with the appliance.
- Never leave an appliance unattended while in use.
- Do not use an appliance for any purpose other than its intended use.
- Do not place an appliance on or near a hot gas flame, electric element or on a heated oven. Do not place on top of any other appliance.
- Do not let the power cord of an appliance hang over the edge of a table or bench top or touch any hot surface.
- For safety reasons and to avoid maintenance by unskilled persons, some appliances are 'sealed' using tamperproof screws. Such appliances should always be returned to the nearest Sunbeam Appointed Service Centre for adjustment or repair if required.
- Do not operate any electrical appliance with a damaged cord or after the appliance has been dropped or damaged in any manner. If damage is suspected, return the appliance to the nearest Sunbeam Appointed Service Centre for examination, repair or adjustment.
- For additional protection, Sunbeam recommend the use of a residual current device (RCD) with a tripping current not exceeding 30mA in the electrical circuit supplying power to your appliances.
- Do not immerse the appliance in water or any other liquid.

If you have any concerns regarding the performance and use of your appliance, please visit www.sunbeam.com.au or contact the Sunbeam Consumer Service Line. Ensure the above safety precautions are understood.

Safety Precautions For Your Tower Fan

- Do not use outdoors.
- Do not run the cord of the fan under carpeting. Do not cover the cord with throw rugs, runners or other floor coverings. Arrange the cord away from traffic areas so that it will not be tripped over.
- Do not use this fan in the immediate surrounds of a bath, shower, laundry area or swimming pool.
- Be sure the fan is placed on a dry, even surface. Do not use on soft surfaces, such as beds, where opening may become blocked.
- Keep your fan away from heat sources, corrosive gases and avoid direct sunlight.
- This fan is only to be used with the base fitted and in good condition.
- Disconnect the power plug before dismantling, assembling or before cleaning.
- Always unplug the fan when not in use for any long length of time.
- The fan must not be used if the guards are damaged in any way.
- Do not insert or allow foreign objects to enter any ventilation or exhaust openings as this may cause electric shock or fire, or damage to the fan.
- Never insert fingers, pencils or any other objects through the guards whenever the power plug is connected, especially while running.
- Avoid touching mobile parts of the fan.
- Do not attempt to move your fan whilst it is operating. If your fan needs to be moved, please ensure that it is turned off and you use the carry handle on top of the tower.
- When scrapping the fan at the end of its useful life, follow local regulations.

Important Instructions - Retain For Future Use

If you have any concerns regarding the performance and use of your appliance, please visit www.sunbeam.com.au or contact the Sunbeam Consumer Service Line. Ensure the above safety precautions are understood.

Locating Your Tower Fan

1. Always locate your fan on a flat level surface.
2. Your tower fan should be located in a dry, cool, well ventilated location. Keep your fan away from heat sources, corrosive gases and avoid direct sunlight.
3. Do not attempt to move your tower fan whilst it is operating. If your fan needs to be moved, please ensure that it is turned off and you use the carry handle at the rear of the fan.

Features Of Your Sunbeam Tower Fan

Remote control storage

When not in use, store your remote control in the handy storage compartment on the rear of the fan body.

Carry handle

Convenient carry handle allows you to easily carry your fan from room to room.

Power button

Simply press the power button to turn the unit on.

Control panel

The easy to read control panel allows you to quickly see what functions have been selected on your tower fan.

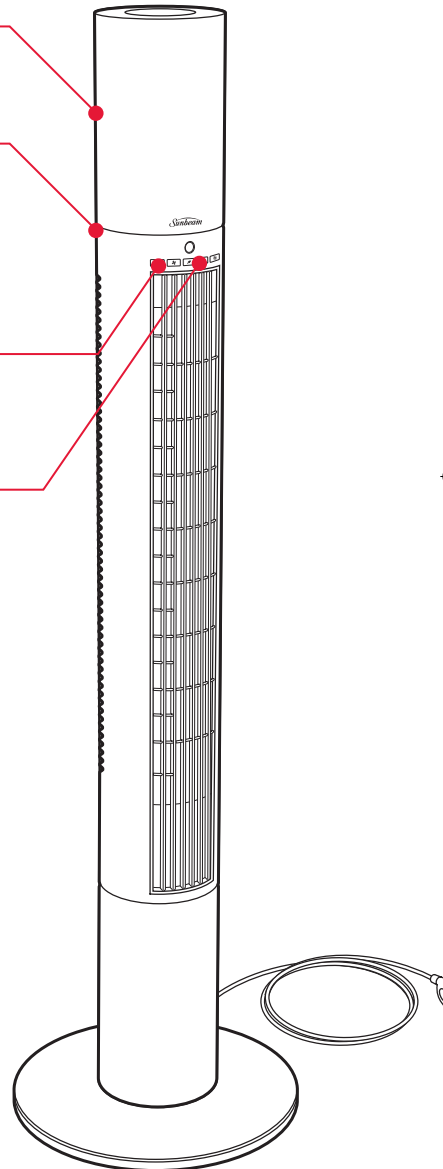

Remote control

Adjust the fan setting, auto off or oscillation from anywhere in the room using the full function remote control.

Fan speed button

Choose from 3 speed settings, low medium or high.

Auto Off button

The auto off timer allows you to set your tower fan to turn off after either 2, 4 or 8 hours.

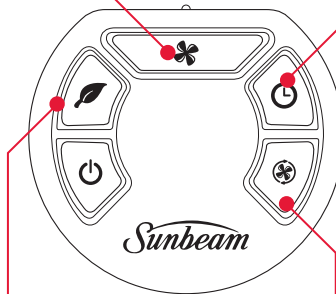

Nature mode

When used in nature mode, the fan speed is randomly adjusted, giving the feeling of a natural breeze.

Oscillation

Your tower fan oscillates 70°, distributing cool air throughout the room.



Assembling Your Tower Fan

Remove the screws from beneath the tower

1. Using a phillips head screwdriver, remove the 6 screws from underneath the tower.
2. Put the screws aside. You will need them to secure the base.

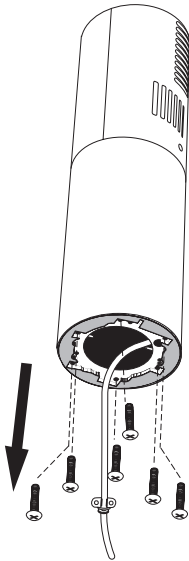

Lower the tower onto the base

1. Feed the cord through the hole in the centre of the base.
2. Align the tower so that the lug on the base lines up with the large hole in the bottom of the tower, as shown.
3. Push the tower down onto the base until it is firmly held into position.

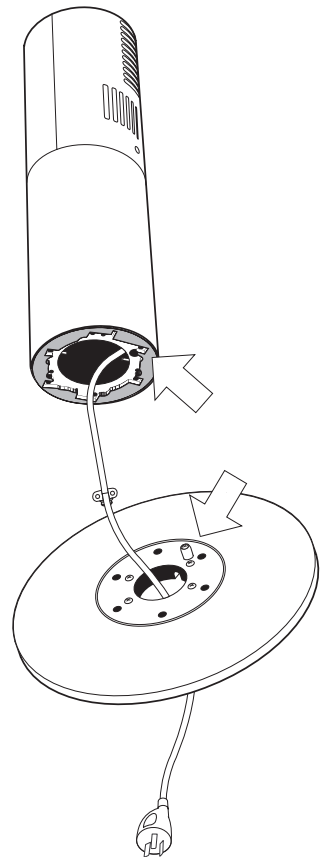

Assembling Your Tower Fan (continued)

Screw the tower to the base

Use the 6 screws you put aside earlier to secure the tower to the base.

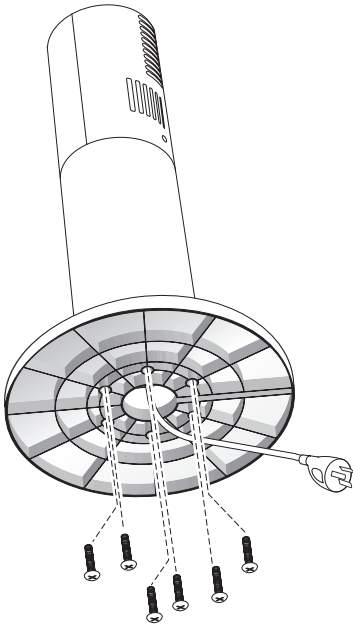

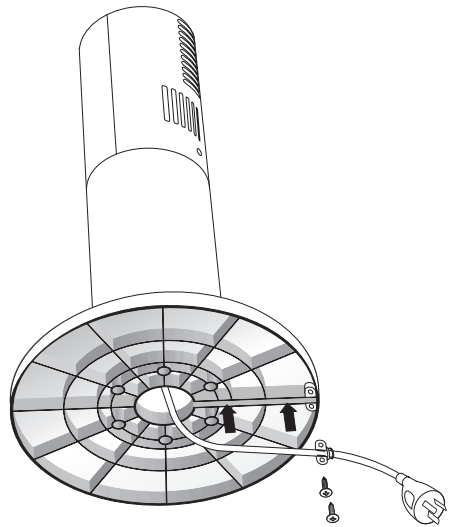

Clip the cord into place

1. Feed the cord along the channel underneath the base.
2. Screw the cord into the edge of the base using the two screws provided.
3. Stand the fan upright. It is now ready for use.



Using Your Tower Fan

Switching the fan on

1. Place the fan on a flat level surface.
2. Insert the plug into a 230/240V power outlet and turn the power on.
3. Press the power button .
4. Press the fan speed button  to select low, medium or high depending on your preference.

Switching the fan off

- To switch the fan off, simply press the power button .
- While the fan remains plugged in to the power socket, the fan will remember your last fan speed, oscillation and mode setting for the next time you switch the fan on again.
- If you will not be using the fan for a length of time, it is advisable to turn the power off at the wall socket and unplug the power cord.

Selecting a fan speed setting

Your Sunbeam tower fan has 3 speed settings as follows:

- low speed fan speed light turns red
- medium speed fan speed light turns orange
- high speed fan speed light turns green

To select a fan speed, simply press the fan speed button  on the tower or the remote. Each press of the button will increase the fan speed and then return back to the lowest speed again.

Using Your Tower Fan (continued)

Using the remote control

1. Remove the remote control from its compartment at the rear of the tower as shown.
2. Point the remote towards the control panel on the front of the tower to operate.

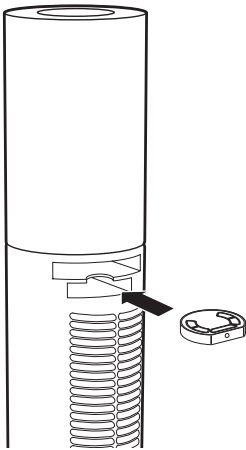

Changing the batteries

1. Slide the rear cover off the remote control unit.
2. Replace the spent batteries with 2 fresh LR41 batteries as shown.
3. Replace the rear cover.

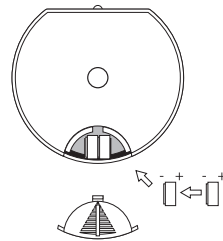

Using Your Tower Fan (continued)

Using the auto off timer

The auto off timer automatically switches the fan off after a preset number of hours.



To activate this feature, simply press the auto off button  on the tower or on the remote control unit.

1. Press the auto off button once to switch the fan off after 2 hours. The timing light on the tower will turn red.
2. Press the auto off button again to have the fan switch after 4 hours. The timing light on the tower will turn orange.
3. Press the auto off button once more to have the fan switch after 8 hours. The timing light on the tower will turn green.

To cancel the setting, keep pressing the auto off button until it cycles past 8 hours and returns to its normal setting. The auto off timer will be deactivated, the timing light will be off, and the fan will remain on until it is switched off manually.

Using the oscillation function

The 70 degree oscillation function can be used on any setting.

1. Turn the unit on and select any fan speed.
2. Press the  button on the tower or the remote. The  button will illuminate and the fan will begin to oscillate from side to side.



To stop the fan from oscillating, simply press the  button once again.

Using Your Tower Fan (continued)

Nature mode

Nature mode provides an extra level of comfort by simulating the natural rise and fall of the wind over time. You can use this mode on any fan speed setting.

To use Nature mode:

1. Choose a fan speed.
2. Press the  button on either the fan or the remote. The  button will illuminate.

The fan will now vary its speed every few seconds between the chosen fan speed, each lower fan speed, and off. For example, if you set the fan speed to medium, the actual fan speed will alternate between medium, low and off.

Troubleshooting Guide

If your tower fan fails to operate check the following:

- Make sure the electrical outlet or circuit breaker is working.
- Check for obstructions around the air intake grill.

If your remote control fails to operate check the following:

- Ensure that you point the remote towards the front of the fan.
- Check that the batteries are not worn. Replace if necessary.

Care And Cleaning

- Ensure that your fan is switched off and disconnected from the power outlet before cleaning.
- Carefully wipe your fan using a clean cloth. Do not use abrasive cleaners or brushes to clean the appliance as these may scratch the surface.
- Take care that excessive dust does not build up in the air-intake and air-outlet grill, and clean it occasionally using a dry brush or vacuum cleaner.
- Store the fan in a cool dry place when not in use, in its original carton if possible.

2 Year Replacement Guarantee

We are so confident of the quality of our product, should this appliance develop any malfunction within 2 years of purchase (3 Months commercial use) due to faulty materials or manufacture, we will replace it for you absolutely free.

Should you experience any difficulties with your appliance, please phone our free call customer service line for advice on 1300 881 861 in Australia, or 0800 786 232 in New Zealand.

Alternatively, simply return the faulty appliance to your place of purchase, along with your purchase receipt.

Your Sunbeam 2 Year Replacement Guarantee naturally does not cover misuse or negligent handling, and excludes breakables such as glass or ceramic items, and normal wear and tear.

Similarly, your 2 Year Replacement Guarantee does not cover damage to household surfaces as a result of water or other substances leaking from your appliance, nor does it cover freight costs.

In Australia, this guarantee is additional to the conditions and guarantees which are mandatory as implied under the Trade Practices Act 1974 and State and Territory legislation.

Sunbeam Service Centres

Sunbeam has established a network of authorised service centres throughout Australia and New Zealand to provide quick, convenient service for our customers.

Should your appliance require repair or service, either during or after the guarantee period, contact your nearest service centre.

For a complete list of Sunbeam's authorised service centres:

Australia

www.sunbeam.com.au/service
1300 881 861

New Zealand

www.sunbeam.co.nz/service
0800 786 232



Consumer Hotline

In Australia

Visit www.sunbeam.com.au

Or call 1300 881 861

In New Zealand

Visit www.sunbeam.co.nz

Or call 0800 786 232

 is a registered Trademark of Sunbeam.

Made in China.

Due to minor changes in design or otherwise,
the product may differ from the one shown in this leaflet.

© Copyright Sunbeam Corporation Limited 2008.

ABN 45 000 006 771

Sunbeam Corporation is a division of GUD Holdings Ltd.