

Sunbeam

Cafe Latte

Pump espresso machine with
temperature status LCD

Instruction Booklet
EM5600

Please read these instructions carefully
and retain for future reference.



Contents

Sunbeam's Safety Precautions	2
About espresso coffee	3
Features of your Sunbeam Café Latte	4
Using the control panel	7
Reference guide to using your espresso machine	9
Preparing your espresso machine before use	14
Guide to the perfect espresso	15
Guide to milk texturing	17
Using the hot water function	18
Espresso recipes	19
Care and cleaning	21
Descaling	23
Trouble shooting guide	25

Important instructions – retain for future use.

تأكد من تفهم احتياطات السلامة المذكورة اعلاه

請務必理解上述的安全預防措施。

Assurez-vous que les précautions ci-dessus relatives à la sécurité sont bien comprises

Versichern Sie sich daß die obenstehenden Sicherheitsmaßnahmen Verstanden werden

Βεβαιώνετε πως οι παραπάνω προφυλάξεις ασφαλείας γίνονται κατανοητές

Pastikan bahwa tindakan-tindakan keselamatan seperti di atas dimengerti anda

Accertatevi che le suddette norme di sicurezza siano comprese a dovere

上記の注意事項をよくお読みになり、安全を御確認ください

Уверете се дека погоре споменатите мерки на претпазливост се добро разбрани

Asegúrese de que las precauciones de seguridad precedentes sean bien comprendidas

کاری بکنید کہ احتیاطهای بالا حتماً درک بشوند

ต้องแน่ใจว่า ข้อควรระวังเรื่องความปลอดภัยข้างต้น เป็นที่เข้าใจกันดี

Yukarda belirtilen güvenlik önlemlerinin anlaşılığundan emin olunuz

Xin kiểm chắc rằng những biện pháp làm an toàn kể trên được hiểu rõ

Sunbeam's Safety Precautions

SAFETY PRECAUTIONS FOR YOUR SUNBEAM ESPRESSO MACHINE.

- Always place the unit on a flat, level surface.
- Do not operate without water in reservoir. Fill reservoir with only clean and cold water. Observe maximum filling volume is 2.1 litres.
- Do not remove the filter handle during the espresso pour or water flow as the unit is under pressure. Removing the filter handle during either of these operations can lead to a scalding or injury.
- The steam wand becomes very hot during texturing milk and water flow. This may cause burns in case of contact, therefore avoid any direct contact with the steam wand.
- Always disconnect the plug from the power outlet prior to cleaning the espresso machine or if there is any problem during the coffee making process.
- Do not allow the power cord to come into contact with the hot parts of the espresso machine, including the cup warming plate and steam wand.
- Do not place hands directly under the steam, hot water or coffee pour as this can lead to a scalding or injury.

Sunbeam is very safety conscious when designing and manufacturing consumer products, but it is essential that the product user also exercise care when using an electrical appliance. Listed below are precautions which are essential for the safe use of an electrical appliance:

- Read carefully and save all the instructions provided with an appliance.
- Always turn the power off at the power outlet before you insert or remove a plug. Remove by grasping the plug - do not pull on the cord.
- Turn the power off and remove the plug when the appliance is not in use and before cleaning.
- Do not use your appliance with an extension cord unless this cord has been checked and tested by a qualified technician or service person.
- Always use your appliance from a power outlet of the voltage (A.C. only) marked on the appliance.
- This appliance is not intended for use by persons (including children) with reduced physical, sensory or mental capabilities, or lack of experience and knowledge, unless they have been given supervision or instruction concerning use of the appliance by a person responsible for their safety.
- Children should be supervised to ensure that they do not play with the appliance.
- The temperature of accessible surfaces may be high when the appliance is operating.
- Never leave an appliance unattended while in use.
- Do not use an appliance for any purpose other than its intended use.
- Do not place an appliance on or near a hot gas flame, electric element or on a heated oven.
- Do not place on top of any other appliance.
- Do not let the power cord of an appliance hang over the edge of a table or bench top or touch any hot surface.
- Do not operate any electrical appliance with a damaged cord or after the appliance has been damaged in any manner. If damage is suspected, return the appliance to the nearest Sunbeam Appointed Service Centre for examination, repair or adjustment.
- For additional protection, Sunbeam recommend the use of a residual current device (RCD) with a tripping current not exceeding 30mA in the electrical circuit supplying power to your appliances.
- Do not immerse the appliance in water or any other liquid unless recommended.
- Appliances are not intended to be operated by means of an external timer or separate remote control system.
- This appliance is intended to be used in household and similar applications such as: staff kitchen areas in shops, offices and other working environments; farm houses; by clients in hotels, motels and other residential type environments; bed and breakfast type environments.

If you have any concerns regarding the performance and use of your appliance, please visit www.sunbeam.com.au or contact the Sunbeam Consumer Service Line.

- 2 Ensure the above safety precautions are understood.

About espresso coffee

Congratulations on the purchase of your Sunbeam Café Latte espresso machine. Sunbeam's experience in designing appliances for the home has produced a range of pump espresso machines that are as beautiful as they are functional.

The Sunbeam Café Latte makes producing cafe-quality coffee at home easier than ever before. As the correct water temperature for brewing great tasting espresso is between 92 - 94°C, the Café Latte has been designed with a LCD which relays the status of the water temperature. This indicates the best time for coffee making or creating steam for texturing milk.

As our love affair with coffee deepens, our search for the perfect espresso continues.

A growing favourite for coffee lovers at any time of the day is the Café Latté, hence the extra cup height clearance so the espresso can pour straight into a Latté glass or your favourite mug.

Drinking authentic café quality coffee at home is guaranteed with the Sunbeam Café Latte espresso machine.

The Café Latte espresso machine is designed with quality die-cast metal components and includes many features that make producing delicious coffee at home even easier.

We hope you enjoy your new espresso machine and should you need any further assistance, please don't hesitate to contact the Sunbeam Coffee Hotline on free call 1300 881 861 .

Features of your Sunbeam Café Latte

Warming plate

Effectively pre-warms up to 9 espresso cups.

Control panel with LCD

Easy to use control panel with an LCD showing the status of the water temperature.

Group head

Brass and phenolic filter handle

Water level indicator

The water level indicator floats through the drip tray grid indicating how full the drip tray is. The top of the indicator has a red band for easy identification.

Measuring spoon

Tamp

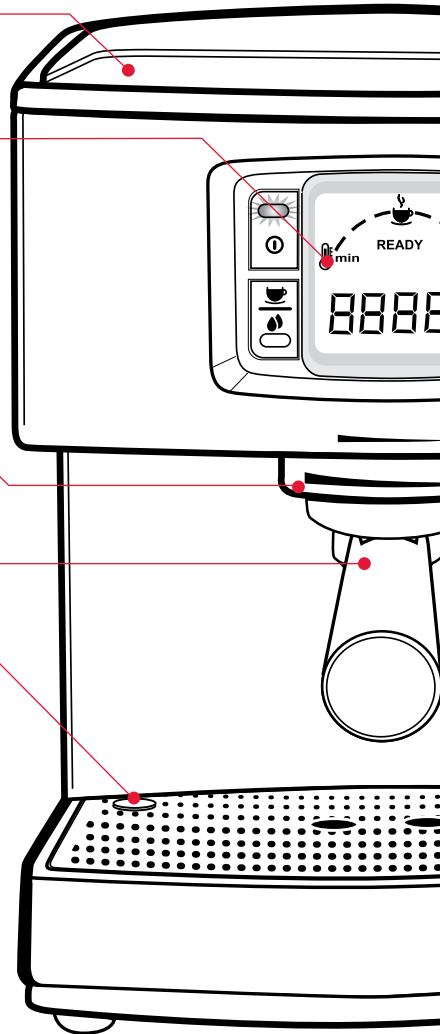

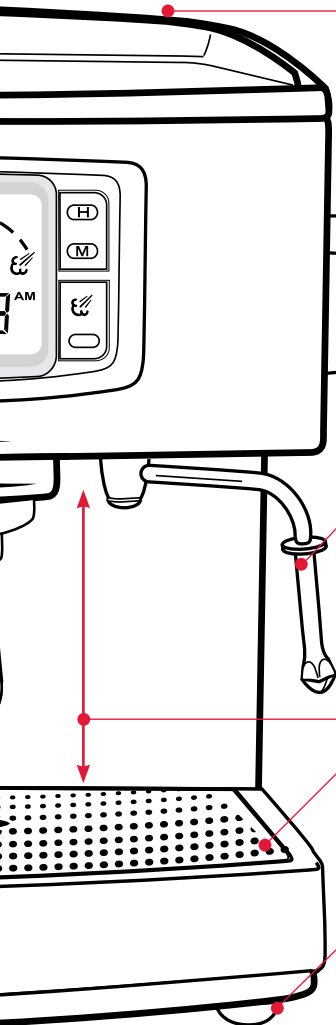

2.1L water reservoir

Removable water reservoir for easy filling, simply lift in any direction.

Operating dial

Easy to operate – turn to the left for espresso/hot water, or to the right for steam.

Steam wand

Extra cup height clearance

Additional clearance between the filter handle and the drip tray is designed to suit taller cups.

Removable drip tray and grill

Designed with no dirt traps for small coffee granules, milk or any other spills. You can simply wipe clean all surfaces. The drip tray and grill can be completely removed for easy cleaning.

Non-slip rubber feet

Makes the unit sturdy, preventing it from slipping or scratching the benchtop.

500ml jug

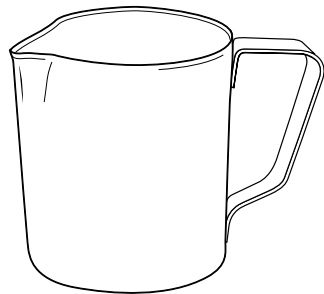

1 cup filter

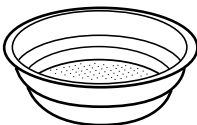

2 cup filter

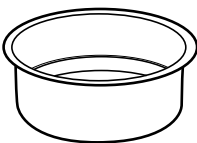

Features of your Sunbeam Café Latte

15 Bar Pump

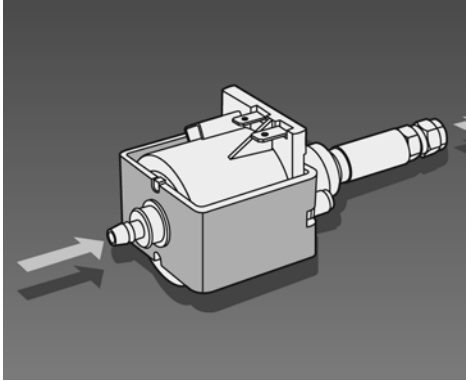

Italian designed and manufactured, the machine is fitted with a 15 BAR pump delivering the pressure required for a complete extraction of oils, coffee solids and aroma.

Crema System

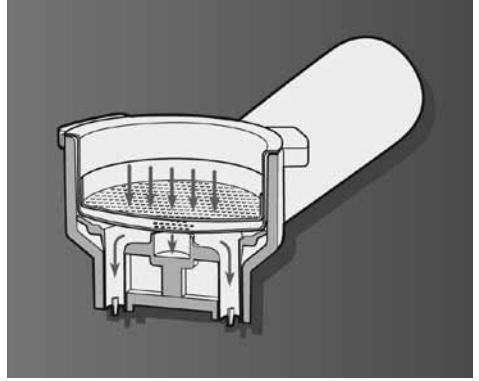

Italian designed the cream system consists of a dual-floor filter creating additional back pressure and stabilising baffle that helps retain temperature and produces a steady pour of espresso.

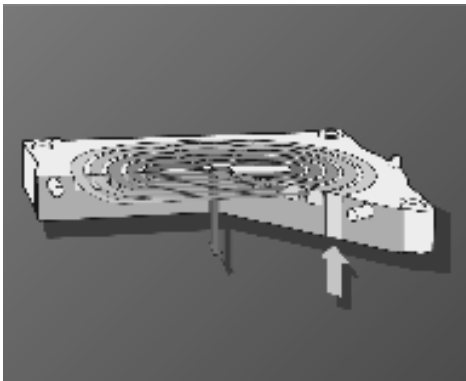

Thermoblock Heating System



The thermoblock heating system heats the water ensuring the precise temperature is achieved for each function. Additionally, the thermoblock is coated with non-stick material to slow scale build up and reduce the frequency of cleaning required.

Using the control panel

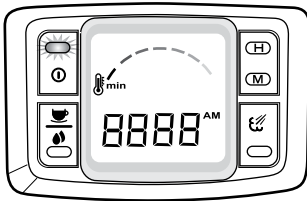

Power

Press the 'POWER' button once to turn the espresso machine on. The light located on the  power button will illuminate red and the temperature indicator line on the LCD will start to flash from  symbol; this is to indicate that your espresso machine is on and is heating up.

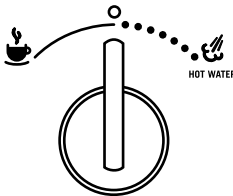

Note: Before turning on the espresso machine ensure that the operating dial on the side of the espresso machine is in the off position.



Depending on the function selected, the temperature line on the LCD will track around to either the  espresso or  steam temperature setting. When the espresso machine is heated and ready to use 'READY' will appear on the LCD.

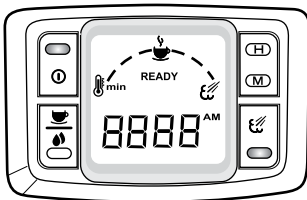

Note: Remember that if 'READY' is not displayed on the LCD the espresso machine is adjusting the temperature of the heating system.



To turn the espresso machine off, simply press the  power button.

Clock

Note: The clock will automatically begin keeping time if the correct time is not set. The correct time does not need to be set to operate the espresso machine. To set the clock simply press the 'H' button to select the hour, ensuring that AM/PM appears correctly and 'M' button to select the minutes.

Note: Holding down either the 'H' or 'M' buttons will allow for rapid time change.

Espresso/Hot water

When the espresso machine is switched on and the espresso machine is in espresso/hot water mode, the red light on  power button and the orange light on the  button will be illuminated.

Note: Should the espresso machine not be in espresso/hot water mode, so the orange light on  button is not on, the coffee maker needs to press the button to activate the espresso/hot water mode. By design the temperature of the espresso machine will adjust as necessary.

Using the control panel (continued)

Once the espresso machine is heated to the correct temperature, the temperature indicator line will stop flashing and ☕ and 'READY' will appear on the LCD, the coffee maker is then able to use the espresso machine.

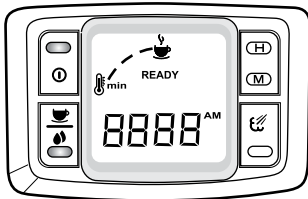

The coffee maker simply needs to turn the operating dial anticlockwise to the espresso setting to start the pour and turn it back to the off position to stop.

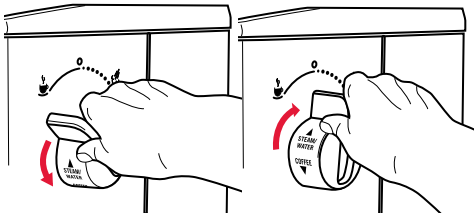

Steam

When the espresso machine is switched on and the espresso machine is in steam mode, the red light on ⏻ power button and the orange light on the steam button will be illuminated.

Note: Should the espresso machine not be in steam mode, so the orange light on the ☕ steam button is not on, the coffee maker needs to press the ☕ steam button to activate the steam mode. By design the temperature of the espresso machine will adjust as necessary.

Once the espresso machine is heated to the correct temperature, the temperature indicator line will stop flashing and ☕ and 'READY' will appear on the LCD, the coffee maker is able to use the espresso machine.



The coffee maker simply needs to turn the operating dial clockwise to the steam setting to start and turn it back to the off position to stop.

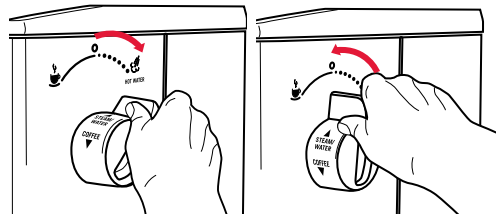

Reference guide to using your espresso machine

The diagrams below and on the following pages are to assist you in operating your Café Latte espresso machine. Each of the diagrams is numbered. Throughout this instruction booklet reference will be made to these diagrams so each of them has been numbered for convenience and ease of use.

For example: Fill the water reservoir (1) (2) (3) (4) (5) with cold tap water...
Each time you see these numbers please refer back to the diagrams.

Preparing the espresso machine.

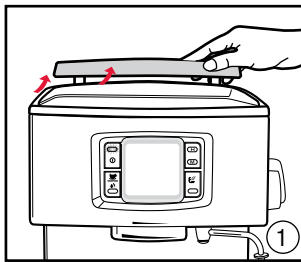

Open lid of water reservoir.

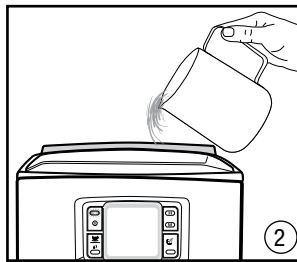

Fill in place with cold water.

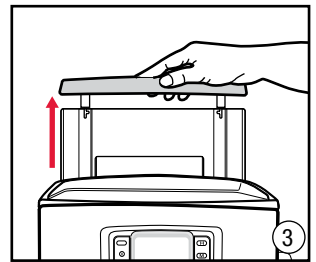

Remove water reservoir.

OR

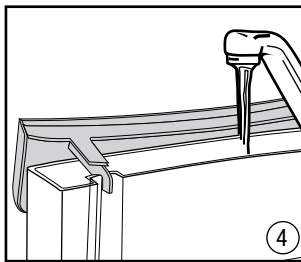

Fill at sink with cold water.

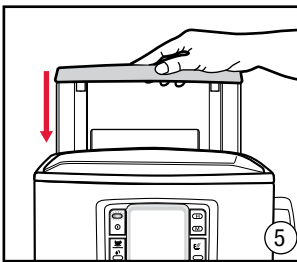

Replace the water reservoir.

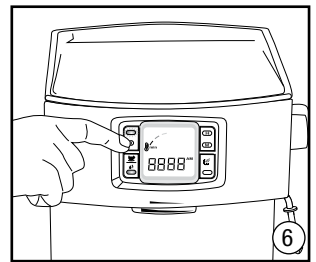

Press 'POWER' button to turn machine on.

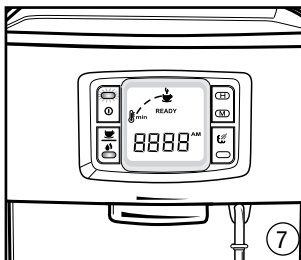

The espresso machine is ready to use.

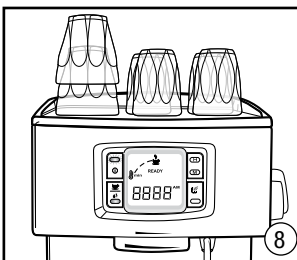

Warming the espresso cups.

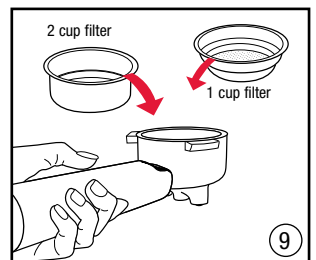

Select appropriate filter and place into handle.

Reference guide to using your espresso machine (continued)

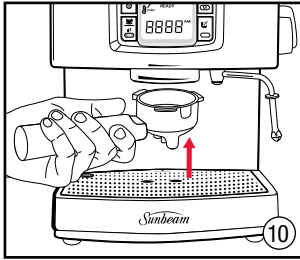

Place filter handle onto group head.

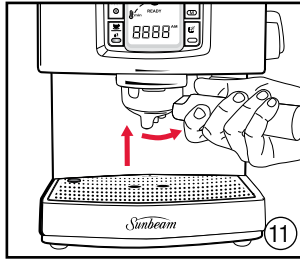

Turn filter handle to the right, as far as it will go.

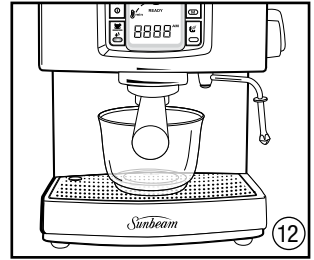

Place large container under both pouring spouts.

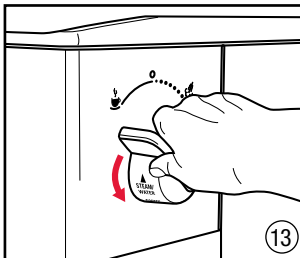

Turn the operating dial to the espresso setting and allow water to run through.

Making the espresso

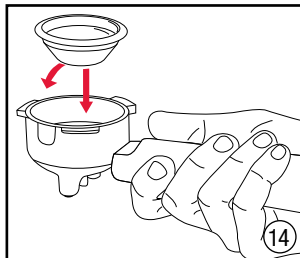

Select appropriate filter and place into handle.

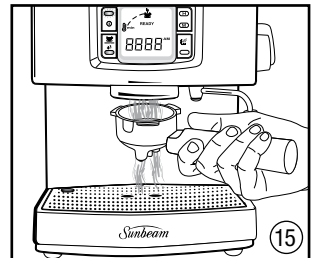

Hold filter handle and purge with water to preheat.

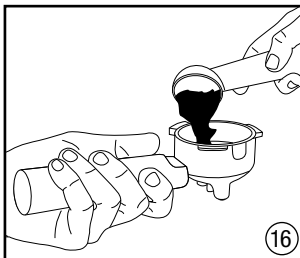

Place finely ground coffee into filter.

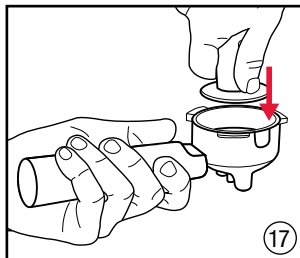

Tamp the coffee grounds.

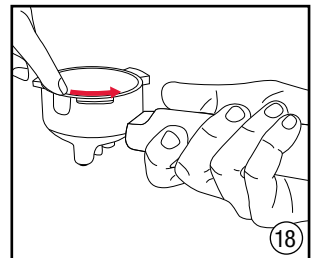

Wipe the edge of filter to remove any coffee grounds.

Reference guide to using your espresso machine (continued)

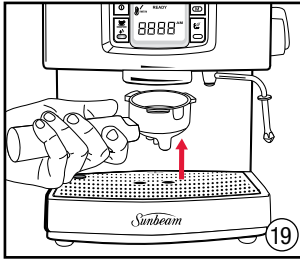

Place filter handle onto group head.

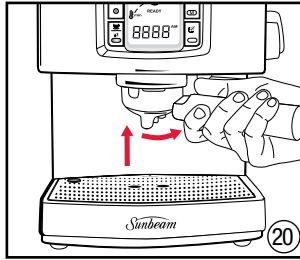

Turn filter handle to the right, as far as it will go.

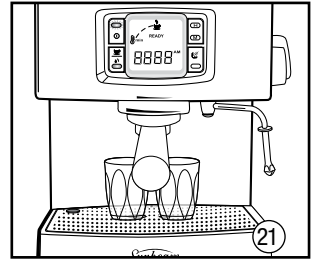

Place glasses/cups below pouring spouts.

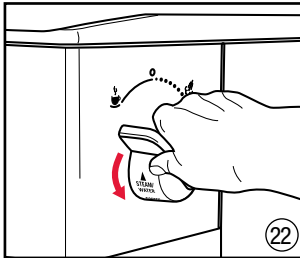

Turn the operating dial to start and stop the espresso pour.

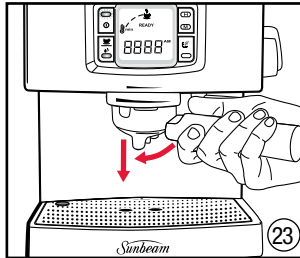

Remove filter handle by turning to the left.

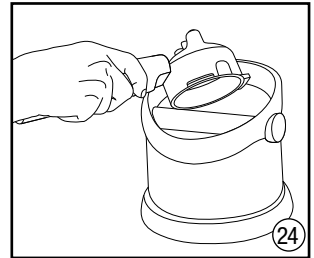

Discard the used coffee grinds.

Texturing milk

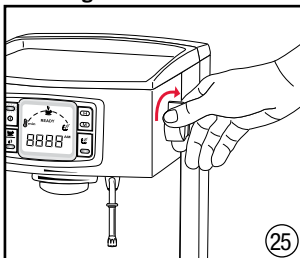

Purge the steam wand by turning dial to the steam setting.

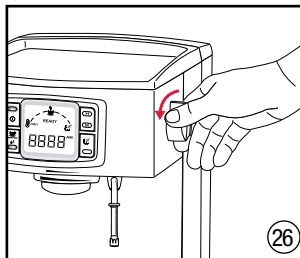

Turn off steam by turning dial to the off position.

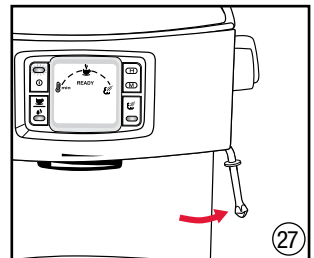

Swing steam wand to the side of espresso machine.

Reference guide to using your espresso machine (continued)

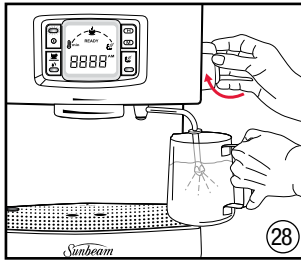

Place steam wand into milk, approx. 1cm below surface and activate the steam function.

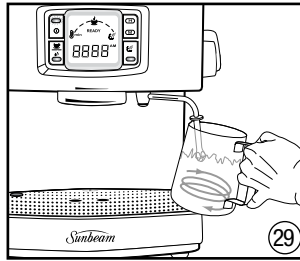

Angle jug to rest steam wand on spout and place nozzle just below surface of the milk.

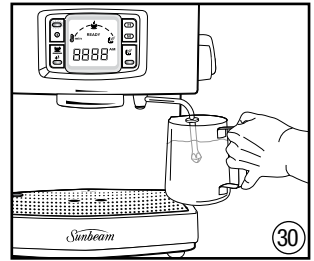

Raise the jug until nozzle is in the centre of milk.

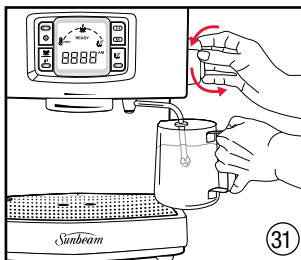

Close the steam by turning dial to the off position.

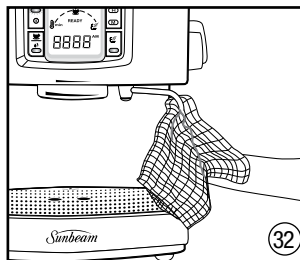

Wipe steam nozzle and wand with damp cloth and purge a small amount of steam.

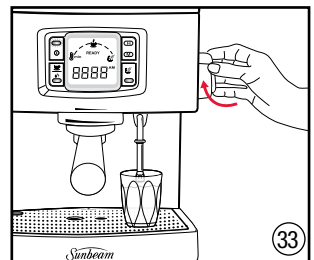

Hot water

Place cup under steam nozzle and activate the hot water function by turning dial to the  steam setting.

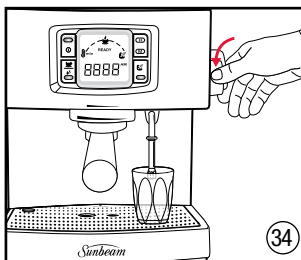

Close the hot water by turning dial to the off position.

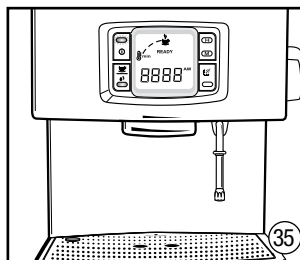

Swing the steam/hot water wand over the drip tray.

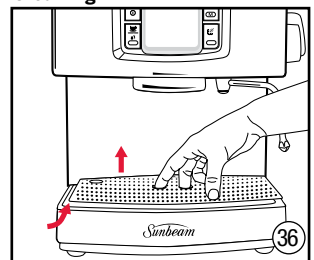

Cleaning

Remove the drip tray grill.

Reference guide to using your espresso machine (continued)

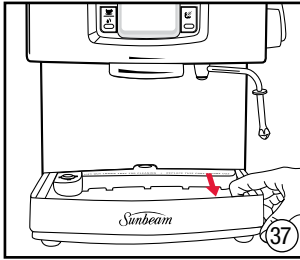

Remove drip tray.

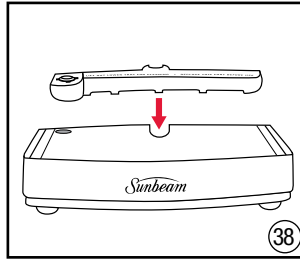

Ensure plastic lining is clipped back into position in the drip tray.

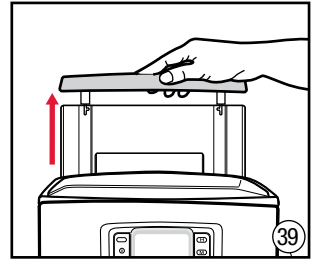

Remove water reservoir.

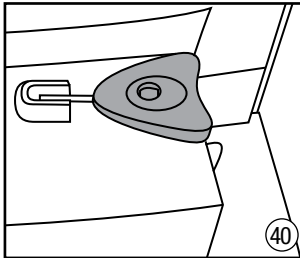

Remove the GREY cleaning pin from the base of the espresso machine where the water reservoir sits.

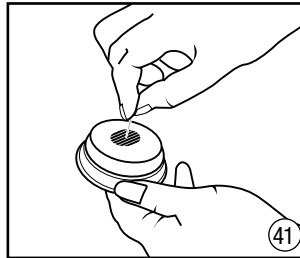

Insert the cleaning pin into the single hole in the base of the filter.

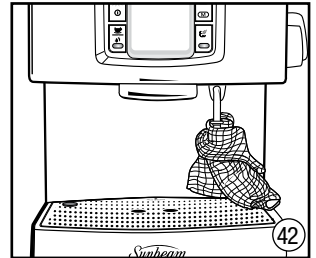

Wrap steam wand with damp cloth and turn steam on for 10 seconds.

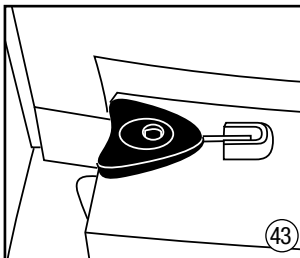

Remove the BLACK steam nozzle cleaning pin from the base of the espresso machine, where the water reservoir sits.

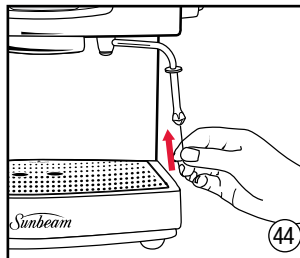



Insert cleaning pin into the hole in the base of the steam wand.

Preparing your espresso machine before use

1. Place the espresso machine onto a dry, stable benchtop.
2. Ensure the drip tray and grill are in place.
3. Fill the espresso machine with water. There are a couple of ways in which the water reservoir can be filled;

- a) Simply lift the lid of the water reservoir at the top of the espresso machine (1) and using a jug, fill with fresh cold water or filtered water (2).
- b) Alternatively the water reservoir can be removed and filled with fresh cold water. To do so, lift the lid and using it as a handle simply slide out the water reservoir (3). Then fill with fresh cold water or filtered water (4). Replace the water reservoir firmly and close the lid (5).



4. Insert the power cord into a 230-240V AC power outlet and switch the power on. Press the  power button once to turn the espresso machine on (6). The light located on the power button will illuminate red and the temperature indicator line on the LCD will start to flash from the  symbol, this is to indicate that your espresso machine is on and is heating up.



When the temperature indicator line on the LCD has stopped flashing and 'READY' is displayed, this indicates that the espresso machine is heated and ready to use (7).

Note: Before turning on the espresso machine ensure that the operating dial on the side of the espresso machine is in the off position.

5. Place glasses and cups on the warming plate (8).

Important: For first time use or if the machine has not been used for some time, it is important that the machine is rinsed as follows:

6. Fit the filter handle with either the one or two cup filter basket (9). Secure the filter handle to the group head (10) (11).
7. Place a sufficiently large container under both pouring spouts (12).
8. Ensure the espresso machine is in espresso/hot water mode, so the red light on the  power button and the orange light on the  button are illuminated.



Note: Should the espresso machine not be in espresso/hot water mode, so the orange light on the  button is not on, the coffee maker needs to press the  button to activate the espresso/hot water mode. By design the temperature of the espresso machine will adjust as necessary.



Once the espresso machine is heated to the correct temperature, the temperature indicator line on the LCD will stop flashing and  and 'READY' will be displayed.

Tip: Remember if 'READY' is not displayed on the LCD the espresso machine is adjusting the temperature of the heating system.

9. Turn the operating dial anticlockwise to the  espresso setting (13) and allow the water to run through until the water reservoir is empty.

Guide to the perfect espresso

Before starting to prepare for making espresso, ensure the espresso machine is in espresso/hot water mode, so the red light on the  power button and the orange light on the  button are illuminated.

Note: Should the espresso machine not be in espresso/hot water mode so the orange light on the  button is not on, the coffee maker needs to press the  button to activate the espresso/hot water mode.

Preheat Glasses

1. Preheat the glasses/cups by filling them with hot water as this will assist to preserve the crema of the espresso. Set the glasses/cups aside.

Preheat Filter Handle and Filter Basket

2. Select the appropriate filter basket and place it into filter handle (14).

Tip: Use the one cup filter basket for a single serve of espresso and the two cup filter basket for a double serve of espresso.

3. Take the filter handle, hold it under the group head and purge water. With the filter basket positioned under the group head turn the operating dial anticlockwise to the  espresso setting to start the water flow and turn it back to the off position to stop (15).

4. Dry the filter basket.

Dosing and Tamping

5. Using the measuring spoon supplied, place finely ground coffee into the filter basket (16).
6. Rest the filter handle with the filter basket in position onto the benchtop. Take the coffee tamp, apply firm level packing pressure (17), twisting 90 degrees to polish the grounds. This seals the surface of the coffee cake.

7. Brush any excess coffee grounds from around the edge of the filter basket (18).

Important: Be sure not to over dose the filter basket with coffee.

Tip: The coffee dosage and the degree of tamping should remain the same every time you make a coffee the only thing that should vary is the coarseness of the coffee grounds and this will vary depending on the bean. For example to achieve a slower espresso pour rate use a finer grind and a coarser grind for a faster espresso pour rate.

Tip: Ensure the coffee tamp is dry because if it is wet the coffee grinds will stick to it.

The Espresso Pour

8. Lock the filter handle onto the group head (19)(20).
9. Empty the glasses/cups and place below the pouring spouts (21).

Note: Check to see that the espresso machine is ready for use, remember that if 'READY' is not displayed on the LCD the espresso machine is adjusting the temperature of the heating system.

10. Turn the operating dial anticlockwise to the  espresso setting to start the pour and turn it back to the off position to stop (22).
11. Check the espresso pour. The ideal pour is dark and caramel with reddish reflections.
12. Serve espresso immediately.

Caring for your Espresso Machine

13. Remove the filter handle from the group head (23).
14. Discard the used coffee grinds from the filter basket (24).

Guide to the perfect espresso (continued)

Tip: After each use of the espresso machine we recommend that a small amount of water is cycled through the group head as this will wash out any old or used coffee grinds stuck to the underside of the group head. Simply turn the operating dial to the ☕ espresso setting and allow some water to run through.

Standby Mode

After 1 hour of non-use the espresso machine will automatically switch to standby mode.

To tell you that the espresso machine is in standby mode, 'STANDBY' will be displayed on the LCD and nothing else.

After a further 26 hours of non-use the espresso machine will turn off.

When the machine is in standby mode by pressing any button or turning the operating dial will return the espresso machine to normal.

Guide to milk texturing

Milk texturing is the steaming of milk. The steam does two things, firstly it heats the milk and secondly the steam mixes air with the milk to form an 'emulsion' of tiny bubbles that gives a silky velvet texture. Similar to making an espresso, perfecting the art of milk texturing takes time and practice.

Tip: Remember espresso is the foundation for all café style drinks and the milk is the variable.

Before starting to prepare for milk texturing, ensure the espresso machine is in steam mode, so the red light on the **Ⓢ** power button and orange light on the **☁** steam button are illuminated.

Note: Should the espresso machine not be in steam mode, so the orange light on the **☁** steam button is not on, the coffee maker needs to press the **☁** steam button to activate the steam mode.

1. Determine how much milk is needed based on the number of cups being made or the size of the texturing jug.

Tip: Keep in mind that the volume of milk will increase or 'stretch' during the texturing.

2. Pour cold refrigerated milk into a stainless steel jug, between $\frac{1}{2}$ to $\frac{2}{3}$ full.

Tip: Store the stainless steel jug in the fridge so that it is well chilled. Also be sure not to rinse the jug with warm water before use.

3. Purge the steam wand of any water.
With the steam wand positioned over the drip tray activate the steam function by turning the operating dial to the **☁** steam setting (25). Once any water has been purged close the steam by turning the operating dial to the off position (26).
4. Swing the steam wand to the side of the espresso machine (27).
5. Place the steam wand into the milk so that the nozzle is about a centimetre

below the surface and activate the steam function by turning the operating dial to the **☁** setting (28).

6. Angle the jug so that the steam wand is resting on the spout of the jug and lower the jug until the tip of the steam nozzle is just below the surface of the milk. This will start to create a whirlpool action in the milk (29).

Note: Do not allow the steam to spurt unevenly or it will create aerated froth/large bubbles. If this is happening raise the jug so that the steam nozzle is lowered deeper into the milk. Remember the ideal consistency is a silky velvet texture.

7. As the steam heats and textures the milk, the level of the milk in the jug will begin to rise. As this happens follow the level of the milk by lowering the jug, always keeping the tip of the steam nozzle just below the surface.
8. Once the foam is created raise the jug until the steam nozzle is in the centre of the milk (30).

Tip: The amount of foam required will vary depending on the drinks being made, for example a cappuccino requires more foam than a flat white.

9. Close the steam immediately when the milk is heated to between 60-65°C by turning the operating dial to the off position (31).

Tip: If you don't have a thermometer a good indication that the correct temperature has been reached is when you are unable to leave the palm of your hand against the side of the jug for more than 3 seconds.

Important: Do not boil the milk.



10. Remove the jug, immediately wipe the steam nozzle and wand with a clean damp cloth (32) and purge a small amount of steam.



Guide to milk texturing (continued)

11. With the jug in hand tap the jug on the bench top to release the trapped air bubbles and then swirl the jug in a circular motion until the milk becomes shiny and no bubbles remain, this helps

the milk and froth combine for an even consistency. By swirling the milk you can see the foam in the jug swirling with your movement this will enable you to judge the thickness of your foam.

Using the hot water function

When using the hot water function the espresso machine needs to be in espresso/hot water mode, so the red light on the  power button and the orange light on the  button are illuminated.

Note: Should the espresso machine not be in espresso/hot water mode, so the orange light on the  button is not on, the coffee maker needs to press the  button to activate the espresso/hot water mode.

The hot water function is ideal for preparing long blacks, hot chocolate and filling coffee plungers and tea pots.

1. Place the cup or container under the steam/hot water nozzle and activate the hot water function by turning the steam operating dial to the  steam setting (33).
2. Once you have dispensed the required amount of hot water into the cup or container, close the hot water by turning the operating dial to the off position (34).
3. Remove the cup or container and swing the steam/hot water wand over the drip tray to catch any drips of water (35).

Espresso Recipes

ESPRESSO (SHORT BLACK)

Espresso is a concentrated, full bodied coffee with a stable layer of cream on top – known as ‘crema’. An espresso is the foundation of all café coffee. Variations are achieved by adding different amounts of milk and froth.

- 90mL espresso glass or demitasse cup
- single espresso (30-35mL)



MACCHIATO

Macchiato, Italian for ‘to stain or mark’. Traditionally served as a standard espresso with a dash of milk and a small dollop of froth into the middle of the ‘crema’.

- 90mL espresso glass or demitasse cup
- single or double espresso
- marked with steamed milk froth



LONG BLACK

A standard espresso with hot water, served in a regular coffee cup or mug. The hot water is added first so that the ‘crema’ is maintained.

- 190mL cup
- hot water (to taste)
- single or double espresso



FLAT WHITE

Another old favourite, the Flat White is an espresso with steamed milk, served in a regular coffee cup or mug. The layer of frothed milk on top should be 2mm to seal the coffee.

- 190mL cup
- single or double espresso
- steamed milk



Espresso Recipes (continued)

CAFFE LATTE

An espresso with steamed milk, typically served in a glass. The layer of frothed milk on top should be 10mm to seal the coffee.

- 220mL glass or cup
- single or double espresso
- steamed milk



CAFFE MOCHA

Made in a similar way to a cappuccino but with the addition of drinking chocolate. Simply stir the chocolate into the espresso prior to adding the steamed milk and froth.

- 190-240mL cup or tall glass
- single or double espresso
- two teaspoons of drinking chocolate
- two-thirds milky coffee, one-third froth



CAPPUCCINO

This delicious drink is an espresso with steamed milk, topped with creamy froth and a dusting of chocolate. The resulting drink is approximately two-thirds milky coffee, one-third froth.

- 190-240mL cup
- single or double espresso
- two-thirds milky coffee, one-third froth
- dusted with chocolate



CON PANNA

A variation on the original Vienna coffee, this delicious drink is made up of an espresso topped with lightly whipped cream. It can also be dusted with cinnamon or drinking chocolate.

- 190mL cup
- single or double espresso
- lightly whipped cream
- dusted with cinnamon or chocolate



Care and Cleaning

The coffee making process involves extracting oils out of coffee grinds to make espresso coffee. Deposits of these oils build up over time and affect the taste of the coffee and operation of the espresso machine.

Regular cleaning to remove these oils is essential and will maintain the quality of the coffee the espresso machine produces and result in less maintenance being required. This is easy to do by following a few quick and easy cleaning steps after each coffee making session;

- ☑ Cycle water through the group head,
- ☑ Purge steam through the steam wand,
- ☑ Wipe the steam wand clean with a damp cloth immediately after use,
- ☑ Remove the filter basket from the filter handle and clean away any old coffee oils, and
- ☑ Empty the drip tray and rinse.

Important: Never wash any of the espresso machine parts or accessories in the dishwasher.

Drip tray and grill

Remove the grill and drip tray at regular intervals to empty (36) (37). Clean with water and a little non-abrasive washing up liquid, rinse and dry.

Over time it is normal for the inside of the drip tray to be stained by the oils in the coffee.

Note: Ensure that when you are replacing the drip tray and grill that the plastic lining is in position (38).

Group head, filter handle & filter baskets

The filter baskets and filter handle should be rinsed with warm water after each use and then dried thoroughly.

To clean the group head of any old coffee grinds cycle water through and wipe the group head and around the inside rim with a damp cloth.

Should the holes in the filter baskets become clogged with coffee granules use a fine bristled brush to remove them.

Important: Should the filter remain blocked after normal cleaning, supplied with your espresso machine is a cleaning pin. The cleaning pin for the filter is the GREY pin located under the base of the water reservoir (39)(40). With the cleaning pin insert it into the single hole in the base of the filter (41).

Group head rubber seal

The group head seal is located on the underside of the group head and creates a seal against the filter handle during the espresso pour.

Note: During long periods of non-use we recommend that the filter handle not be left attached to the group head as this will reduce the life of the seal.

Over time the seal will lose its elasticity and require replacement, depending on use usually every 12 months. Signs that the seal is deteriorating are when the filter handle cannot create the necessary seal and steam escapes from around the group head during the espresso pour.

Note: Contact Sunbeam on 1300 881 861 should you think that the group head seal needs replacing.

Cup warming plate and exterior

Wipe over the unit with a damp cloth and wipe dry. Do not use abrasives or metal scourers as these will scratch the exterior surface.

Care and Cleaning (continued)

Steam wand

Keeping the steam arm clean is essential to ensure maximum efficiency of the steam function. A build up of caramelised/dried milk on the steam wand will impair the steaming and texturing ability of the espresso machine.

Important: Wipe the steam wand clean with a damp cloth immediately after each use and purge a small amount of steam.

Should the milk dry/caramelize on the steam wand, simply wrap the wand with a clean damp cloth, turn the steam wand over the drip tray and turn the steam on for approximately 10 seconds (42). With the cloth still on the steam wand leave to soak for about 5 minutes and you will find that after this time the dry/caramelised milk will easily wipe away. Repeat process if still dirty.

Important: Never clean the steam wand with an abrasive pad as this will damage the steam wand.

Should the steam wand become blocked, supplied with the espresso machine is a cleaning pin. The cleaning pin for the steam wand is the BLACK pin located under the base of the water reservoir (39)(43).

With the cleaning pin insert it into the hole in the base of the steam nozzle (44). Should the steam wand remain blocked unscrew the steam nozzle from the steam wand. Clean the steam nozzle by once again using the cleaning pin then flush under running water.

Descaling

Scale is a surface build up of minerals that naturally occur over time in all appliances that are involved with the heating of water. Therefore the espresso machine will require occasional descaling. It is recommended that the espresso machine is descaled every 4-6 months, this will vary depending on the frequency of use.

Descaling solution

Use any of the following when descaling the espresso machine:

- Sunbeam Espresso Machine Descaling Tablets
- Sunbeam Liquid Descaler, or
- Vinegar Solution.

Descaling the espresso machine

Note: Ensure the espresso machine is turned off and the power cord is unplugged.

1. Remove the water reservoir and rinse clean.

Depending on the descaling solution being used use one of the following:

A. Sunbeam Espresso Machine Descaling Tablets

Fill the water reservoir with 1 litre of warm water and place a descaling tablet into the reservoir. Once the tablet has dissolved replace the reservoir, this takes about 5-7 minutes.

B. Sunbeam Liquid Descaler

Fill the water reservoir with approximately 1.5 litres of water, add 1 capful of Sunbeam Liquid Descaler and replace the reservoir.

C. Vinegar solution

Fill the water reservoir with approximately 1.5 litres of warm water, add 3 tablespoons of vinegar and replace the reservoir.

2. Should the filter handle be attached to the group head remove it, rinse thoroughly under running water and set aside.
3. Using a screwdriver unscrew the brewing filter/shower screen from the underside of the group head.
4. Remove and set aside the filter/screen, washer and screw in a safe place.

Important: Be careful not to lose the filter/screen, washer and screw once you have disassembled the group head.

5. Using a small brush scrub in and around the area at the brewing head, removing all coffee granules.
6. Place a sufficiently large container under the group head.
7. Insert the power cord into a 230-240V AC power outlet and switch the power 'ON'. Press the  power button once to turn the espresso machine on.

Note: Remember if 'READY' is not displayed on the LCD the espresso machine is adjusting the temperature of the heating system.

Once the espresso machine is heated to the correct temperature, the temperature indicator line on the LCD will stop flashing and  and 'READY' will be displayed, this indicates that the espresso machine is heated and ready to use.



8. Turn the operating dial anticlockwise to the  espresso setting and allow half the solution to cycle through the group head.

Important: Do not run descaling solution through the steam wand.

Note: Depending on the size of the container under the group head on occasion this may need to be emptied throughout this process.

9. After half the solution has cycled through turn the operating dial to the off position to stop the flow and then press the  power button to turn the machine off.

Descaling (continued)

10. Leave the machine off for 10-15 minutes to allow the descaler solution to take affect.
 11. Press the  power button once to turn the espresso machine on.
 12. Turn the operating dial to the  espresso setting and allow the remaining solution to cycle through the group head.
 13. Remove the water reservoir from the machine and rinse thoroughly under running water, ensuring that all traces of the descaling solution is removed. Fill with clean water and replace the reservoir.
 14. Turn the operating dial to the  espresso setting and allow the entire water reservoir to cycle through the group head.
- Note:** Depending on the size of the container under the group head on occasion this may need to be emptied throughout this process.
15. When this is finished remove the container under the group head and give the machine a good wipe over.
 16. Carefully replace the rubber seal, brewing filter/shower screen and washer to the group head. Tighten well.
 17. Fill the water reservoir with fresh water and position it on to the machine.

Trouble Shooting guide

PROBLEM	POSSIBLE CAUSE	WHAT TO DO
Coffee runs down the side of the filter handle.	Filter handle is not attached correctly, or has not been tightened sufficiently.	Ensure the handle is firmly positioned onto the group head. See "Guide to the perfect espresso" pg 15.
	Edge of filter insert is not free of coffee granules.	Clean around the top edge of the filter and wipe the group head clean of coffee.
	The group head is dirty.	Wipe group head with a damp cloth.
	The group head is defective.	Contact a Sunbeam Service Centre.
	Group head rubber seal is damaged, or worn.	Contact a Sunbeam Service Centre.
No coffee runs through.	No water in the water reservoir.	Fill reservoir with water.
	Water reservoir not correctly assembled.	Press firmly down on the water reservoir to ensure it is correctly positioned.
	 Operating dial set to setting.	Ensure the operating dial is in the off position.
	Group filter may be blocked.	See "Descaling" pg 23.
	The filter is blocked, the coffee grounds are too fine or tamped down too hard.	Empty out the filter and rinse under water to clean. Wipe the group head with a cloth. Repack the filter and tamp down coffee lightly with compactor.
Coffee pours out in drops.	Coffee grind is too fine or are too compacted.	Ensure you are using an evenly ground coffee and do not compact the grounds so firmly.
	Machine blocked by scale build up.	See "Descaling" pg 23.
Espresso does not have any Crema.	Coffee is old or dry.	Use fresh coffee and once you open the coffee be sure to store it in an airtight container.
	Coffee not compacted firmly enough.	Compact coffee grounds more firmly.
	Coffee too coarse.	Grind the coffee to a finer texture or change brands of espresso coffee to a finer grind.

Trouble Shooting guide (continued)

Espresso does not have any Crema.	Not enough coffee in filter.	See "Guide to the perfect espresso" pg 15.
Handle comes off during group.	Coffee tamped too hard.	Tamp the coffee grounds lighter.
	Coffee grind is too fine.	Change to a coarser grind of coffee.
	Filter handle is not attached correctly, or has not been tightened sufficiently.	Ensure the handle is firmly positioned onto the group head. See "Guide to the perfect espresso" pg 15.
	Top edge of filter is not free of coffee granules.	Clean around the edge of the filter and wipe the group head clean of coffee.
	The group head is dirty.	Wipe group head with a damp cloth.
	The group head is defective.	Contact a Sunbeam Service Centre.
	Group head rubber seal is worn or damaged.	Contact a Sunbeam Service Centre.
Coffee is too cold.	Cups, filter and filter hand are cold.	Pre-heat cups, filters, handle and filter. See "Guide to the perfect espresso" pg 15.
	If making a cappuccino or latte the milk may not be heated enough.	Ensure that milk is heated properly during texturing, but be sure not to boil the milk. See "Guide to milk texturing" pg 17.
No steam from the steam nozzle.	Steam nozzle is blocked.	See "Care & Cleaning" pg 21.
Not enough froth when frothing	Milk is not fresh.	Ensure the milk is fresh.
	Milk temperature is too warm.	Ensure that the milk is well refrigerated before use.
	Jug.	For best texturing results use a stainless steel jug and if possible refrigerate or run the jug under cold water before use.
	Steam nozzle is blocked.	See "Care & Cleaning" pg 21.
	Milk has been boiled.	Start again with fresh, chilled milk.
Uneven cup filling.	Uneven tamping or obstruction in the pouring spouts.	Ensure coffee is tamped evenly and check that there is nothing obstructing the pouring spouts.

Trouble Shooting guide (continued)

Uneven cup filling.	Defective baffle in filter handle.	Contact a Sunbeam Service Centre.
Espresso tastes burnt.	Type of coffee being used.	Experiment with different brands of coffee.
	Appliance has not been rinsed after descaling.	Run a reservoir full of water properly through the machine before making another coffee.
Pump makes an unusually load noise.	No water in reservoir.	Fill the water reservoir.
	Water reservoir not correctly positioned.	Replace the water reservoir firmly into the unit.
Machine does not operate.	Group head filter may be blocked.	Remove filter holder and clean group head. See "Care & Cleaning" pg 21.
	Machine blocked by scale build up.	See "Descaling" pg23.

Please contact Sunbeam directly on Freecall 1300 881 861, if this guide does not solve your query. We have experienced staff on hand to assist, Monday to Friday.

Notes

12 Month Replacement Guarantee

In the unlikely event that this appliance develops any malfunction within 12 months of purchase (3 months commercial use) due to faulty materials or manufacture, we will replace it for you free of charge.

Should you experience any difficulties with your appliance, please phone our customer service line for advice on 1300 881 861 in Australia, or 0800 786 232 in New Zealand. Alternatively, you can send a written claim to Sunbeam at the address listed below. On receipt of your claim, Sunbeam will seek to resolve your difficulties or, if the appliance is defective, advise you on how to obtain a replacement or refund.

Your Sunbeam 12 Month Replacement Guarantee naturally does not cover misuse or negligent handling and normal wear and tear.

Similarly your 12 Month Replacement Guarantee does not cover freight or any other costs incurred in making a claim. Please retain your receipt as proof of purchase.

The benefits given to you by this guarantee are in addition to your other rights and remedies under any laws which relate to the appliance.

Our goods come with guarantees that cannot be excluded under the Australian Consumer Law and under the New Zealand Consumer Guarantees Act.

In Australia you are entitled to a replacement or refund for a major failure and for compensation for any other reasonably foreseeable loss or damage. You are also entitled to have the goods repaired or replaced if the goods fail to be of acceptable quality and the failure does not amount to a major failure.

Should your appliance require repair or service after the guarantee period, contact your nearest Sunbeam service centre.

For a complete list of Sunbeam's authorised service centres visit our website or call:

Australia

www.sunbeam.com.au

1300 881 861

Units 5 & 6, 13 Lord Street
Botany NSW 2019 Australia

New Zealand

www.sunbeam.co.nz

0800 786 232

26 Vestey Drive, Mt Wellington
Auckland, New Zealand

Need help with your appliance?

Contact our customer service team or visit our website for information and tips on getting the most from your appliance.

In Australia

Visit www.sunbeam.com.au

Or call 1300 881 861

In New Zealand

Visit www.sunbeam.co.nz

Or call 0800 786 232

 is a registered trademark.

'Cafe Latte' is a trademark of Sunbeam Corporation.

Made in China.

Due to minor changes in design or otherwise, the product may differ from the one shown in this leaflet.

© Copyright. Sunbeam Corporation Limited 2010.

ABN 45 000 006 771

Units 5 & 6, 13 Lord Street
Botany NSW 2019 Australia

Unit 3, Building D
26 Vestey Drive
Mt Wellington Auckland
New Zealand

Sunbeam Corporation is a division of GUD Holdings Ltd.