

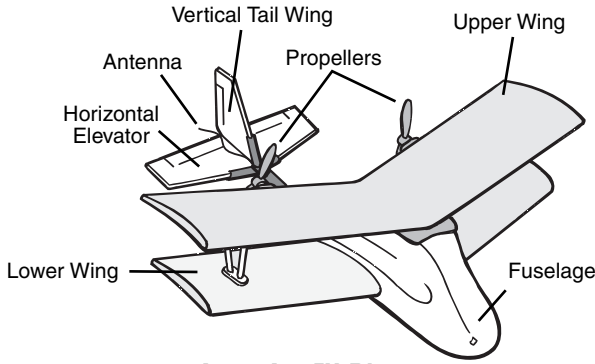

INSTRUCTIONS

- Check to make sure contents are complete:**
- 1 Air Hogs™ RC Aero Ace™
 - 1 Charger/Controller
 - 1 Decal Sticker Sheet
 - 3 Aluminum Stickers



Aero Ace™ Plane

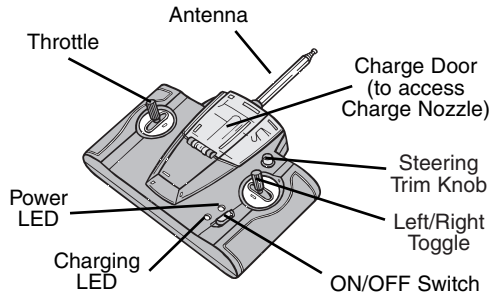

Charger/Controller

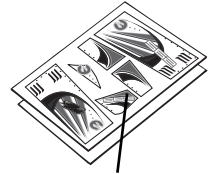

Decal Sticker Sheet

Experience radio-controlled flight with the Air Hogs™ RC Aero Ace™! The Aero Ace™ makes flying fun & easy! Just choose the direction you want to fly and press the controller toggle. The ultra-light Aero Ace™ is powered by a lithium battery for long

flights, features precision speed control and damage-resistant high density foam. The Aero Ace™ also includes an integrated Charger/Controller unit for convenient portability and easy handling on the field. Perfect for both indoor and outdoor flights.

CHARGER/CONTROLLER BATTERY INSTALLATION

1. Use a Phillips screwdriver to loosen the battery door.
2. Slide the battery door to the back and remove.
3. Install **6 AA 1.5-V alkaline batteries** (not included). Be careful to align the positive (+) and negative (-) polarities with the corresponding markings inside the battery compartment.
4. Reinstall the battery door and tighten the screw.

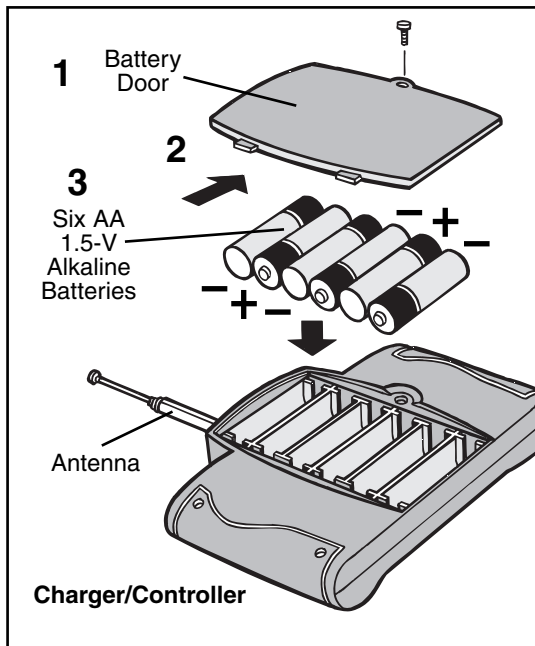

Charger/Controller

IMPORTANT TIP: TURN YOUR CONTROLLER ON TO ENSURE THAT THE BATTERIES ARE INSTALLED PROPERLY. THE RED LIGHT ON THE FRONT OF THE CONTROLLER SHOULD TURN RED.

After each flight, store the plane in the package to prevent damage.

Your Aero Ace™ Plane has preinstalled rechargeable batteries in the plane's fuselage.

Because the Controller's AA batteries are used for 2 functions – charging and controlling, it is recommended they be replaced after every 20 – 25 flights.

APPLYING DECALS

Peel each Mylar label from the adhesive backing and apply the sticker as shown.

IMPORTANT: PLACE THE LABELS ON A FLAT SURFACE TO AVOID CREASES AND BUMPS THAT WILL ADVERSELY AFFECT THE PLANE'S FLIGHT.

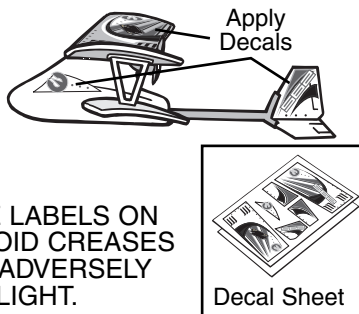

REPAIRS

If the wings on your plane get damaged they can be easily repaired with clear tape as shown.



CHARGING YOUR AIRPLANE

Important Charging Information:

- Before taking your initial flight, charge the plane for a complete charge cycle on your charger.
 - Depending upon the length of future play, you will not need to complete a full charge before each flight.
- NOTE: A shortened charge results in a shorter playtime (may take up to 1/2 hour to fully charge).

1. Push the plane's ON/OFF Switch to the left to set the plane to **OFF**.

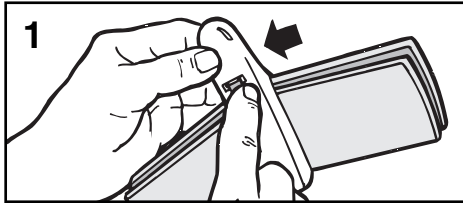

2. Set the Charger/Controller switch to **OFF**.

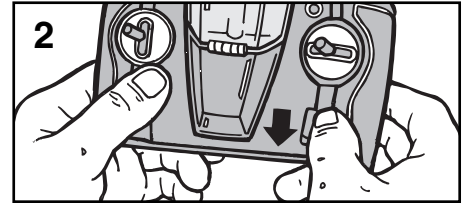

3. Flip the Charge Door open to reveal the Charge Nozzle.

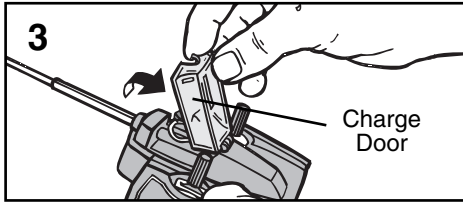

4. Push the Charge Nozzle all the way into the plane's Charger Port located at the bottom of the airplane.

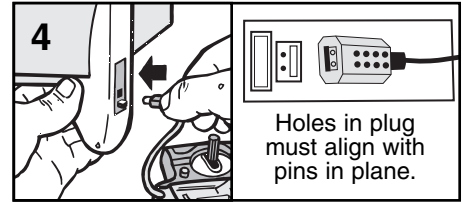

5. During the charging process, the green charge light will turn **ON**. When the Aero Ace™ is completely charged, the green charging light will turn **OFF**.

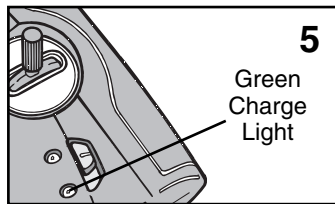

6. Remove Charge Nozzle gently from the plane's charge port and close the charge door.

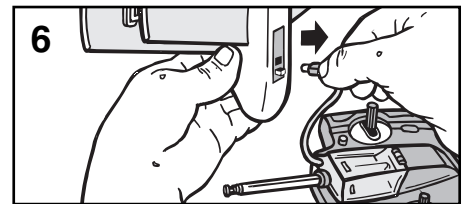

PRE-FLIGHT ENVIRONMENT CHECK

- 1. Location** – Fly in a large wide open, grassy location that is free of buildings, trees, overhead wires, and other obstructions. Do not fly near people or animals.
- 2. Weather** – Fly on mild, sunny days. Do not fly in electrical storms, rain, sleet, snow or other adverse weather conditions. Do not fly if the temperature is below 7°C/45°F. In very cold temperatures, the plane will become fragile and the engine performance will decrease.
- 3. Wind Conditions** – Do not fly in wind. Winds may overpower the plane and make it difficult to control. In windy conditions, it may appear as though you have no control over the plane.

FLYING INDOORS?

Note: Always get a parent's permission to fly your Aero Ace™ indoors.

Location – Fly in a wide open room, far from breakable items – an empty double car garage or unfinished basement are great options. Avoid flying near vents and/or fans, as they may overpower the plane and make it difficult to control.

FLYING INSTRUCTIONS

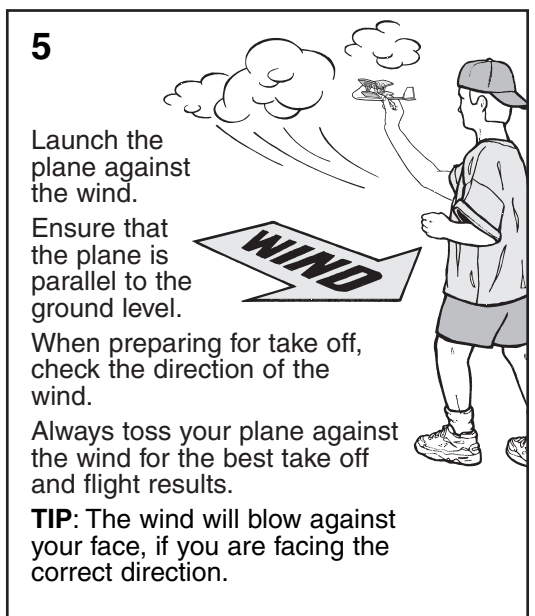
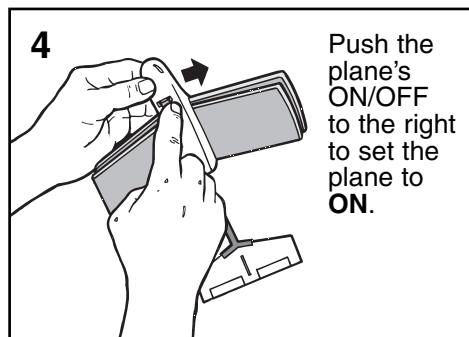
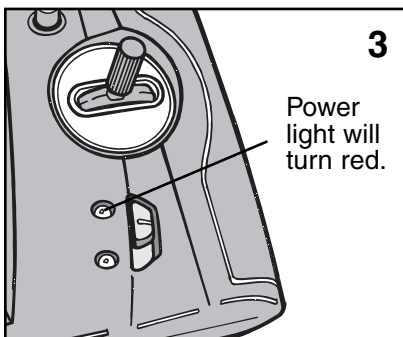
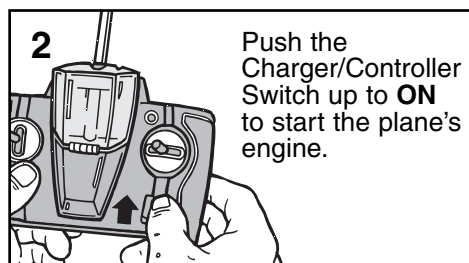
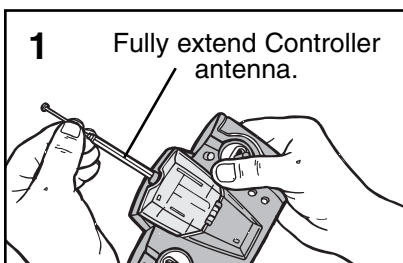

CONTROLLING AIRPLANE FLIGHT

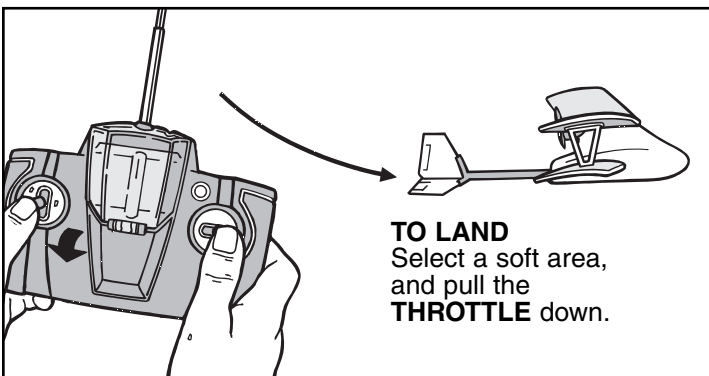
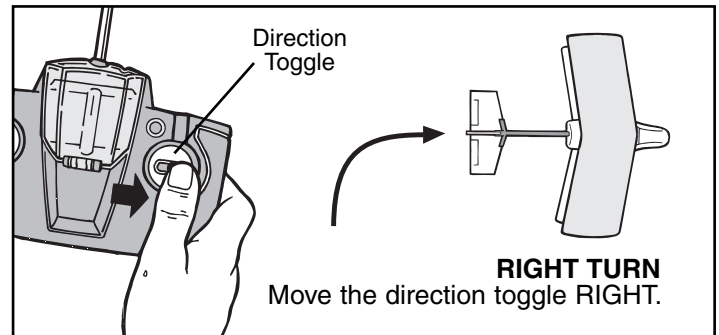
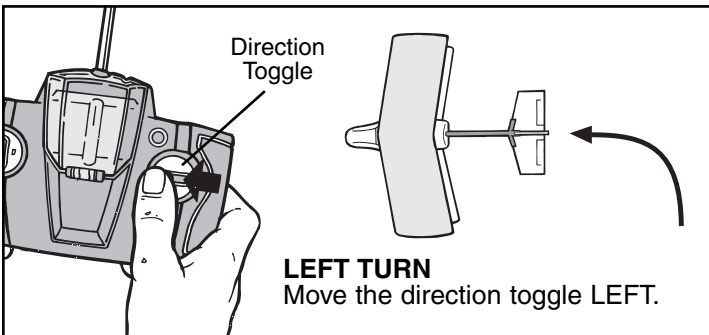
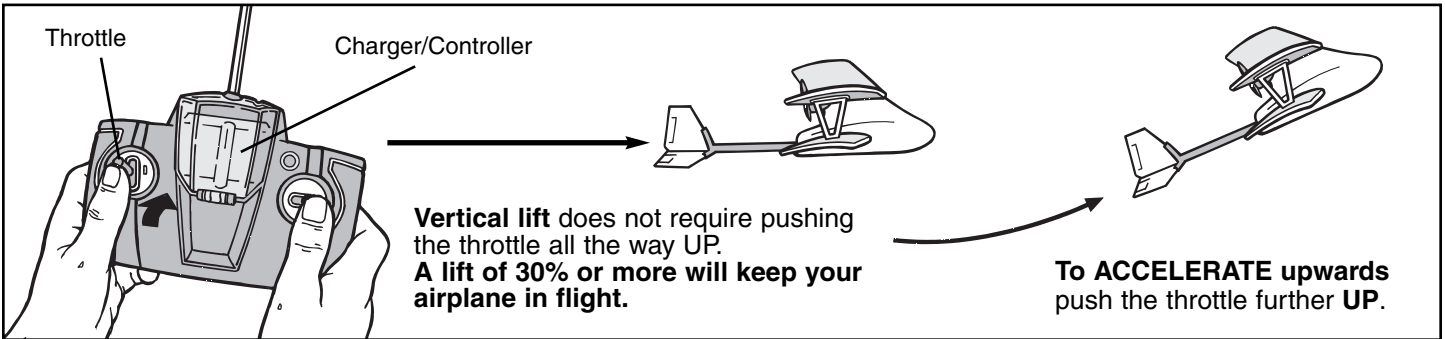

ONCE THE PLANE HAS LANDED

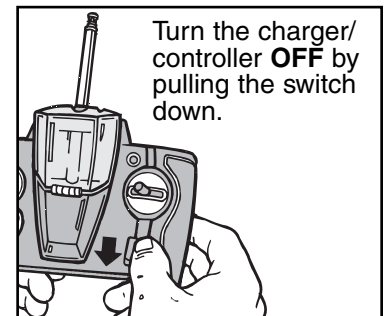
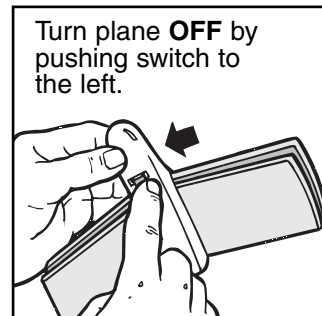

FLIGHT ADJUSTMENTS

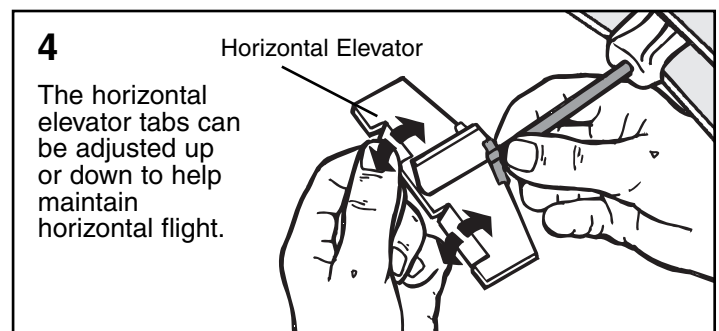
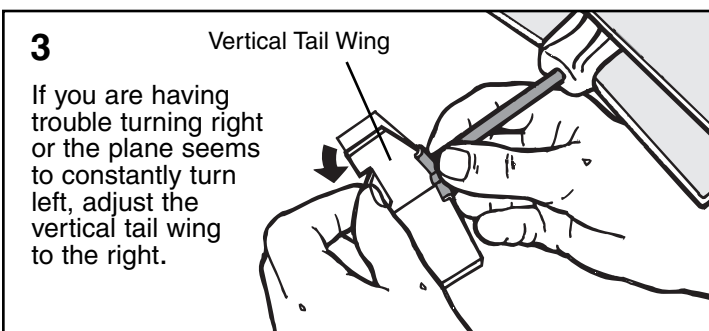
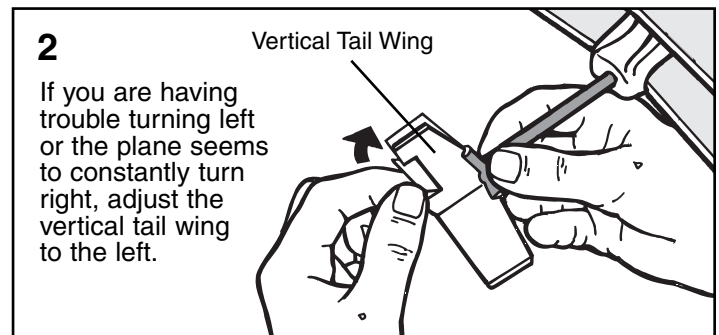
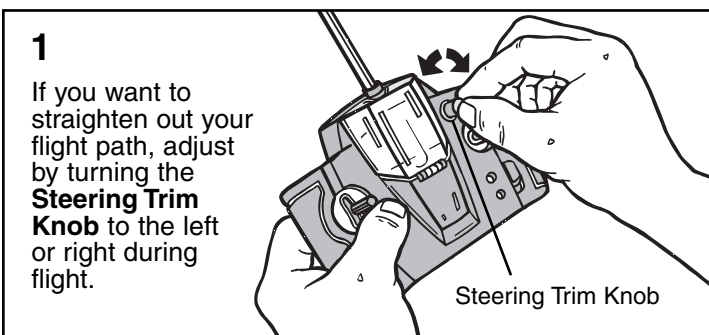

TROUBLESHOOTING GUIDE

PROBLEM	CAUSE	SOLUTION
Plane will not start or has low power.	<ol style="list-style-type: none"> 1. Plane not charged. 2. Battery power is drained. 3. Plane was not set to OFF during charging. 4. Charger/Controller was not set to "Charger OFF". 	<ol style="list-style-type: none"> 1. Charge plane for a complete charge cycle. 2. Replace the Charger/Controller batteries after 20 flights. 3. The plane won't accept a charge in the ON position. Always set to "OFF" before charging. 4. The Charger/Controller will NOT charge in the "Control ON" position. Always set the Charger/Controller to "OFF" before attempting to charge.
Plane will not turn.	<ol style="list-style-type: none"> 1. Control is not ON. 2. Controller antenna is not extended. 3. It's a windy day or you're flying by a vent/fan. 4. Trim knob needs adjusting. 5. Rudder needs adjusting. 	<ol style="list-style-type: none"> 1. Set Controller to "Controller ON" 2. Fully extend Controller antenna before flying. 3. Do not fly in winds. Windy conditions will limit and prevent your ability to control the plane. If flying indoors, do not fly near a vent/ fan. 4. See Flight Adjustments #2 and #3.
Plane is flying too low.	<ol style="list-style-type: none"> 1. Needs more power. 2. The six AA batteries in the Charger/ Controller are drained. 3. Horizontal Stabilizer needs adjusting. 	<ol style="list-style-type: none"> 1. Press the Toggle UP. 2. Install new batteries. 3. See Flight Adjustments #4.
Plane is flying too high.	<ol style="list-style-type: none"> 1. Need to decrease power. 	<ol style="list-style-type: none"> 1. Press the Toggle DOWN.
Level flight is hard to maintain.	<ol style="list-style-type: none"> 1. Horizontal Elevator needs adjustment. 	<ol style="list-style-type: none"> 1. See Flight Adjustments #4.
Motors don't stop when Controller is turned OFF.	<ol style="list-style-type: none"> 1. Set to full throttle. 	<ol style="list-style-type: none"> 1. Turn Controller ON, reduce throttle to 0 and turn Controller OFF.

IMPORTANT BATTERY INFORMATION

REQUIRED BATTERIES: Charger/Controller takes 6 AA Alkaline Batteries (not included).

Battery installation should be performed by an adult. Use only batteries recommended in the instruction sheet. Be careful to install the batteries with the correct polarity, as indicated.

- Do not mix old and new batteries.
- Do not mix alkaline, standard or rechargeable batteries.
- Battery installation should be done by an adult.
- Non-rechargeable batteries are not to be recharged.
- Rechargeable batteries are to be removed from the toy before being charged (if removable).
- Rechargeable batteries are only to be charged under adult supervision

(if removable).

- Only batteries of the same or equivalent type as recommended are to be used.
- Batteries are to be inserted with the correct polarity.
- Exhausted batteries are to be removed from the toy.
- The supply terminals are not to be short-circuited.
- Different types of batteries, or new and used batteries are not to be mixed.
- Exhausted batteries are to be removed, as they will adversely affect the performance.



CAUTION:

PLEASE READ BEFORE CHARGING OR USING BATTERY.

Your plane is equipped with a Lithium Polymer battery; please also pay attention to the following cautions for safe use:

- Do not dispose the battery in fire or heat.
- Do not use or leave the battery near a heat source such as fire or heater.
- Do not strike or throw the battery against hard surfaces.
- Do not immerse the battery in water. Keep the battery in a cool dry environment.

- When charging, only use the battery charger specifically for that purpose.
- Do not over-charge the battery.
- Do not connect the battery to an electrical outlet.
- Do not directly solder the battery or pierce the battery with a nail or other sharp objects.
- Do not transport or store the battery together with metal objects such as necklaces, hairpins, etc.
- Do not disassemble or alter the battery.
- Charge the battery every 6 months.
- Turn off your equipment power switch after use.
- As for a used battery, please recycle the battery by covering the terminals with insulation tape or inserting into an individual polybag.

FCC STATEMENTS:

This device complies with part 15 of the FCC rules. Operation is subject to the following two conditions:

1. This device may not cause harmful interference, and
2. This device must accept any interference received, including interference that may cause undesired operation.

NOTE: This equipment has been tested and found to comply with the limits for a Class B digital device, pursuant to Part 15 of the FCC Rules.

These limits are designed to provide reasonable protection against harmful interference in a residential installation. This may cause harmful interference to radio communications.

However, there is no guarantee that interference will not occur in a particular installation. If this equipment does cause harmful interference to radio or television reception, which can be determined by turning the equipment off and on, the user is encouraged to try to correct the interference by one of more of the following measures:

- Reorient or relocate the receiving antenna.
- Increase the separation between the equipment and the receiver.
- Connect the equipment into an outlet on a circuit different from that to which the receiver is needed.
- Consult the dealer or an experienced radio/TV technician for help.

Spin Master Ltd., 450 Front Street West, Toronto, ON M5V 1B6 Canada
Spin Master, Inc., PMB #10053, 300 International Drive, Suite 100,
Williamsville, NY 14221, USA
Spin Master Toys Far East Limited, Rm #1113, 11/F,
Chinachem Golden Plaza, 77 Mody Rd., Tsimshatsui E., Kowloon, HK
Spin Master France SAS, 36 rue de Sully, 92100 Boulogne, France

North American Consumer Information
Phone: 1-800-622-8339
www.spinmaster.com

Air Hogs TM and Aero Ace TM are trademarks of Spin Master Ltd.
© 2004 Spin Master Ltd. All rights reserved.
Manufactured for and distributed by Spin Master Ltd.
Conforms to safety standards ASTM F963-03,
EN71 Regulatory Requirements. Products and colors may vary.
Please retain this information for future reference.
MADE IN CHINA.

Asst. #44197 U.S. English REV 1

Contains Lithium Polymer battery. Battery must be recycled or disposed of properly.

