

ATTACHMENT ILLUSTRATED PARTS LIST



ATTACHMENT

Mfg. No. Description

1690082 42" Rotary Mower Hitch Assembly



MANUFACTURING, INC.
500 N Spring Street / PO Box 997
Port Washington, WI 53074-0997 USA

www.simplicitymfg.com

© Copyright 2002 Simplicity Manufacturing, Inc. All Rights Reserved.

Rev. 03/2002

TP-400-2623-00-AT-SMA

42" Rotary Mower Hitch Assembly

1690082

NOTE: Unless noted otherwise,
use the standard hardware torque
specification chart.

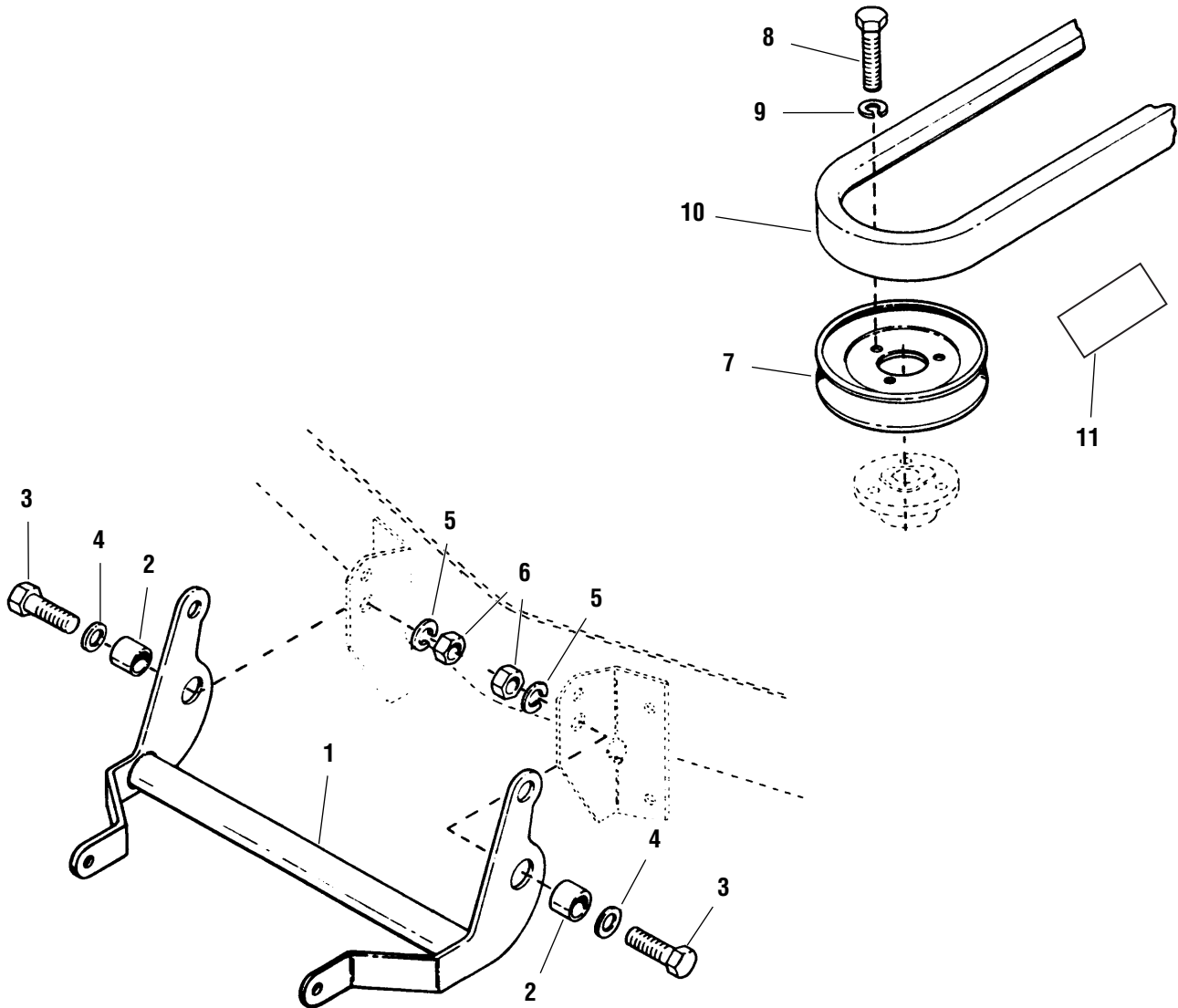

The above parts group applies to the following Mfg. Nos.:

1690082 Hitch, Mower Deck

42" Rotary Mower Hitch Assembly

| REF NO. | PART NO. | QTY. | DESCRIPTION |
|----------------|-----------------|-------------|------------------------------------|
| 1 | 172468 | 1 | ROCKER ARM ASSEMBLY |
| 2 | 105051 | 2 | SPACER |
| 3 | 917279 | 2 | CAPSCREW, Hex Head, 1/2-13 X 1-1/4 |
| 4 | 918430 | 2 | WASHER |
| 5 | 916966 | 2 | LOCKWASHER |
| 6 | 916951 | 2 | NUT, Hex, 1/2-13 |
| 7 | 174189 | 1 | PULLEY |
| 8 | 922606 | 3 | CAPSCREW, Hex Head, 3/8-16 X 1-3/4 |
| 9 | 916965 | 3 | LOCKWASHER |
| 10 | 176439 | 1 | V-BELT |
| 11 | 174845 | 1 | DECAL, Installation |

Footnotes:

The above parts group applies to the following Mfg. Nos.:

1690082 Hitch, Mower Deck

Hardware Identification & Torque Specifications

Common Hardware Types

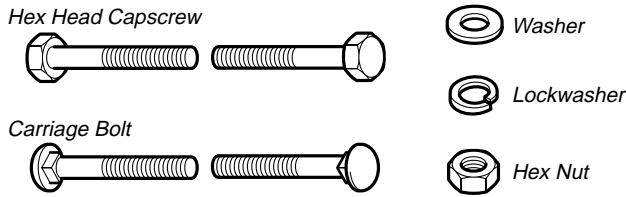

Standard Hardware Sizing

When a washer or nut is identified as **1/2"**, this is the *Nominal size*, meaning the *inside diameter* is 1/2 inch; if a second number is present it represent the *threads per inch*

When bolt or capscrew is identified as **1/2 - 16 x 2"**, this means the *Nominal size*, or *body diameter* is 1/2 inch; the second number represents the *threads per inch* (16 in this example, and the final number is the *body length* of the bolt or screw (in this example 2 inches long).

The guides and ruler furnished below are designed to help you select the appropriate hardware and tools.

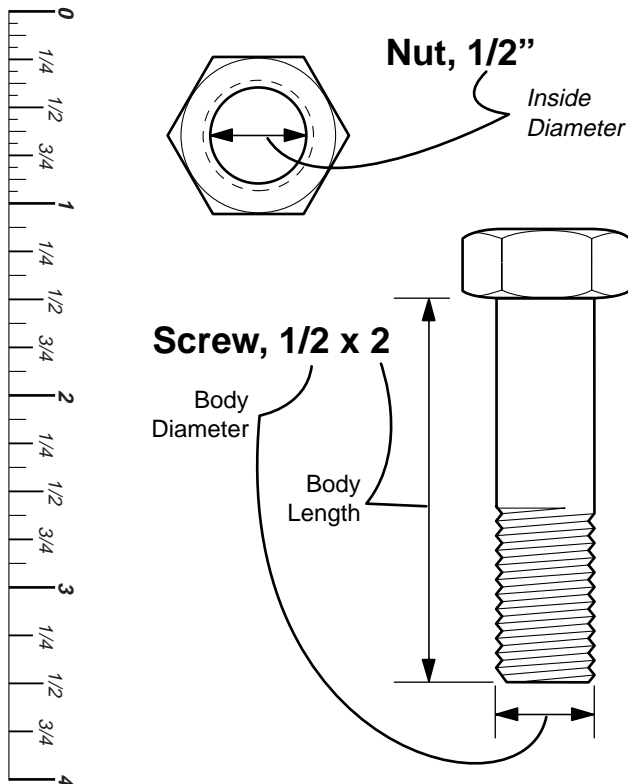

Torque Specification Chart

FOR STANDARD MACHINE HARDWARE (Tolerance ± 20%)

| Hardware Grade | No Marks | | SAE Grade 2 | | SAE Grade 5 | | SAE Grade 8 | |
|----------------|---------------|-------|---------------|-------|---------------|---------|---------------|-----|
| | in/lbs ft/lbs | Nm. | in/lbs ft/lbs | Nm. | in/lbs ft/lbs | Nm. | in/lbs ft/lbs | Nm. |
| 8-32 | 19 | 2.1 | 30 | 3.4 | 41 | 4.6 | | |
| 8-36 | 20 | 2.3 | 31 | 3.5 | 43 | 4.9 | | |
| 10-24 | 27 | 3.1 | 43 | 4.9 | 60 | 6.8 | | |
| 10-32 | 31 | 3.5 | 49 | 5.5 | 68 | 7.7 | | |
| 1/4-20 | 66 | 7.6 | 8 | 10.9 | 12 | 16.3 | | |
| 1/4-28 | 76 | 8.6 | 10 | 13.6 | 14 | 19.0 | | |
| 5/16-18 | 11 | 15.0 | 17 | 23.1 | 25 | 34.0 | | |
| 5/16-24 | 12 | 16.3 | 19 | 25.8 | 27 | 34.0 | | |
| 3/8-16 | 20 | 27.2 | 30 | 40.8 | 45 | 61.2 | | |
| 3/8-24 | 23 | 31.3 | 35 | 47.6 | 50 | 68.0 | | |
| 7/16-14 | 30 | 40.8 | 50 | 68.0 | 70 | 95.2 | | |
| 7/16-20 | 35 | 47.6 | 55 | 74.8 | 80 | 108.8 | | |
| 1/2-13 | 50 | 68.0 | 75 | 102.0 | 110 | 149.6 | | |
| 1/2-20 | 55 | 74.8 | 90 | 122.4 | 120 | 163.2 | | |
| 9/16-12 | 65 | 88.4 | 110 | 149.6 | 150 | 204.0 | | |
| 9/16-18 | 75 | 102.0 | 120 | 163.2 | 170 | 231.2 | | |
| 5/8-11 | 90 | 122.4 | 150 | 204.0 | 220 | 299.2 | | |
| 5/8-18 | 100 | 136 | 180 | 244.8 | 240 | 326.4 | | |
| 3/4-10 | 160 | 217.6 | 260 | 353.6 | 386 | 525.0 | | |
| 3/4-16 | 180 | 244.8 | 300 | 408.0 | 420 | 571.2 | | |
| 7/8-9 | 140 | 190.4 | 400 | 544.0 | 600 | 816.0 | | |
| 7/8-14 | 155 | 210.8 | 440 | 598.4 | 660 | 897.6 | | |
| 1-8 | 220 | 299.2 | 580 | 788.8 | 900 | 1,244.0 | | |
| 1-12 | 240 | 326.4 | 640 | 870.4 | 1,000 | 1,360.0 | | |

NOTES

- These torque values are to be used for all hardware excluding: locknuts, self-tapping screws, thread forming screws, sheet metal screws and socket head setscrews.
- Recommended seating torque values for locknuts:
 - for prevailing torque locknuts - use 65% of grade 5 torques.
 - for flange whizlock nuts and screws - use 135% of grade 5 torques.
- Unless otherwise noted on assembly drawings, all torque values must meet this specification.

Wrench & Fastener Size Guide



1/4" Bolt or Nut
Wrench—7/16"

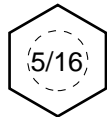

5/16" Bolt or Nut
Wrench—1/2"

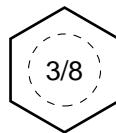

3/8" Bolt or Nut
Wrench—9/16"

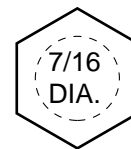

7/16" Bolt or Nut
Wrench (Bolt)—5/8"
Wrench (Nut)—11/16"

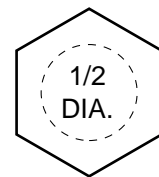

1/2" Bolt or Nut
Wrench—3/4"