

SENCO®

SCN48 SCN49

Operating Instructions
Instrucciones de Operacion
Mode d'Emploi



Senco Products Inc.
8485 Broadwell Road
Cincinnati, Ohio 45244



Questions? Comments?

call SENCOS toll-free Action-line: 1-800-543-4596

or e-mail: toolprof@senco.com www.senco.com



© 2008 by Senco Products, Inc.

Warnings for the safe use of this tool are included in this manual.
Los avisos para el uso seguro de esta herramienta están incluidos
en este manual.

Les consignes pour l'utilisation en toute sécurité de cet outil se
trouvent dans ce manuel.

NFD84U5J - Issued: February 14, 2008

English	Español	Français
---------	---------	----------

TABLE OF CONTENTS	TABLA DE MATERIAS	TABLE DES MATIÈRES
-------------------	-------------------	--------------------

Tool Use	2	Utilisation de l'outil	2
Maintenance	6	Entretien	6
Troubleshooting	7	Dépannage	7
Specifications	8	Spécifications	8
Accessories	9	Accessoires	9
	Especificaciones		8
	Accesorios		9

EMPLOYER'S RESPONSIBILITIES	RESPONSABILIDADES DEL EMPLEADOR	RESPONSABILITÉS DE L'EMPLOYEUR
Employer must enforce compliance with the safety warnings and all other instructions which accompany this tool as shipped from the manufacturer.	El empleador debe hacer cumplir las advertencias de seguridad y todas las otras instrucciones que acompañan a esta herramienta como se la despacha desde el fabricante.	L'employeur doit faire appliquer les consignes de sécurité et toutes les autres instructions qui accompagnent cet outil tel qu'il est livré par son constructeur.
Keep this manual available for use by all people assigned to the use of this tool.	Mantenga este manual disponible para que lo usen todas las personas destinadas a hacer uso de esta herramienta.	Ayez ce manuel à la disposition de toutes les personnes chargées d'utiliser cet outil.
For personal safety and proper operation of this tool, read and understand all of these instructions carefully.	Por razones de seguridad personal y la adecuada operación de esta herramienta, lea y comprenda todas estas instrucciones cuidadosamente.	Pour assurer la sécurité personnelle et le bon emploi de cet outil, lisez et assimilez soigneusement toutes ces instructions.

Tool Use	Uso de la Herramienta	Utilisation de l'Outil
English	Español	Français

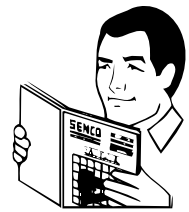







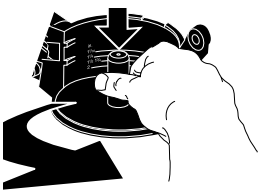

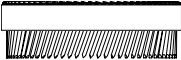
<ul style="list-style-type: none"> ● Read and understand "SAFETY INSTRUCTIONS" manual shipped with this tool before using tool. 	<ul style="list-style-type: none"> ● Antes de usar la herramienta lea y comprenda el manual "INSTRUCCIONES DE SEGURIDAD" despachado con ella. 	<ul style="list-style-type: none"> ● Lisez et assimilez le manuel "INSTRUCTIONS DE SÉCURITÉ" livré avec cet outil avant de l'utiliser.
--	--	---

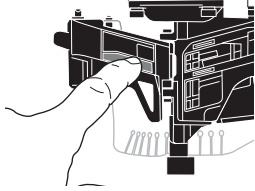
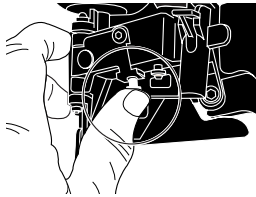
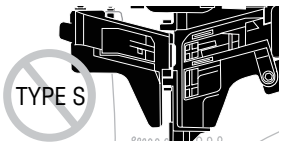
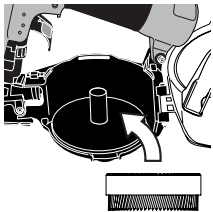
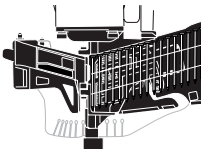

<ul style="list-style-type: none"> ● To Adjust Magazine Squeeze the gate latch and lift open gate. Open Magazine. <p>Lift and shift nail disk to accept different length nails. NOTE: Reference points on magazine coincide with nail lengths.</p>	<ul style="list-style-type: none"> ● Para Ajustar el Cargador Oprima el pasador de la puerta y levántela abriéndola. Abra el cargador. <p>Levante y rote el disco de clavos para que acepte clavos de diferentes longitudes. NOTA: Se encuentran puntos de referencia en la parte acunada del cargador de acuerdo a las longitudes de los clavos.</p>	<ul style="list-style-type: none"> ● Pour régler le magasin Appuyer sur le verrou de porte et ouvrir le volet de magasin. <p>Soulever et tourner le disque à clous pour accepter les clous de différente dimensions. NOTE: Les points de repère sur le magasin correspondent à la longueur des clous.</p>
---	--	--

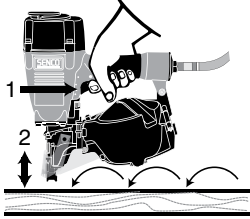
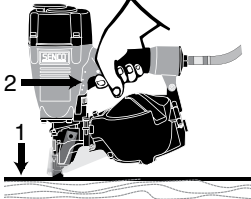

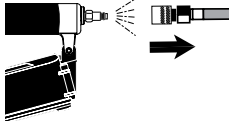
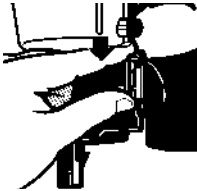

	Tool Use English	Uso de la Herramienta Español	Utilisation de l'Outil Français
<p>PLASTIC CARRIER STRIP WIDTHS</p> <p>TYPE -S (SMALL) </p> <p>TYPE -L (LARGE) </p>	<ul style="list-style-type: none"> ● These tools use either wire collated nails or plastic collated nails. <p>Plastic collated nails come in two different carrier widths.</p> <p>Type S for the small or narrow strip, and Type L for the large or wider strip.</p>	<ul style="list-style-type: none"> ● Estas herramientas usan clavos reunidos sujetos por alambre o en soporte de plástico. <p>Los clavos reunidos en soporte de plástico vienen con dos anchos de soporte diferentes.</p> <p>El tipo S es el de tira de soporte pequeña o angosta, y el tipo L es el de tira de soporte grande o ancha.</p>	<ul style="list-style-type: none"> ● Ces outils utilisent des clous reliés soit par fil soit par plastique. <p>Les clous à liaison plastique existent en deux largeurs de support différentes.</p> <p>Le type S correspond à la bande petite ou étroite, le type L à la bande plus grande ou plus large.</p>
<p>SCN48 Only</p>  	<ul style="list-style-type: none"> ● After loading fasteners with the the Type L carrier strip the lower carrier guide will press itself in when the gate is closed. <ul style="list-style-type: none"> ● Press the button on the gate door to set the tool for the wire collated nails and Type S carrier-strip collated nails. 	<ul style="list-style-type: none"> ● Después de cargar los sujetadores con la tira de soporte tipo L, la guía inferior del soporte encajará por sí misma cuando se cierre la puerta. <ul style="list-style-type: none"> ● Oprima el botón de la puerta para ajustar la herramienta para los clavos reunidos sujetos por alambre y para los clavos reunidos en tira de soporte de plástico tipo S. 	<ul style="list-style-type: none"> ● Après chargement des clous en bande à support type L, le guide inférieur de support sera pressé automatiquement quand la porte est fermée. <ul style="list-style-type: none"> ● Appuyer sur le bouton de la porte de fermeture pour régler l'outil afin de recevoir des clous avec reliure en fils ou des clous en bande à support de type S.
<p>SCN49</p> 	<ul style="list-style-type: none"> ● The SCN49 will not accept Type S Carrier Strip. 	<ul style="list-style-type: none"> ● La SCN49 no acepta la tira de soporte tipo S. 	<ul style="list-style-type: none"> ● Le SCN49 n'acceptera pas de bande support type S.
	<ul style="list-style-type: none"> ● Place the nail coil in the magazine. 	<ul style="list-style-type: none"> ● Ponga el rollo de clavos in el cargador. 	<ul style="list-style-type: none"> ● Placer la bande de clous dans le magasin.
	<ul style="list-style-type: none"> ● Insert first nail into driver track with second nail into the feeder pawl. 	<ul style="list-style-type: none"> ● Inserte el primer clavo en el riel con el segundo clavo dentro del trinquete de alimentación. 	<ul style="list-style-type: none"> ● Insérer le premier clou dans le chemin de clouage avec le deuxième clou dans le cliquet d'alimentation.
	<ul style="list-style-type: none"> ● Close magazine cover and gate. Make sure gate is fully latched. 	<ul style="list-style-type: none"> ● Cierre la cubierta del cargador y la puerta. Asegurese que la puerta este completamente cerrada. 	<ul style="list-style-type: none"> ● Fermer volet de magasin et porte. S'assurer que la porte est bien verrouillée.

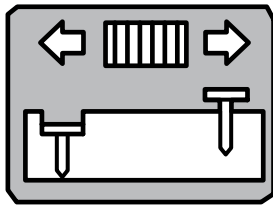
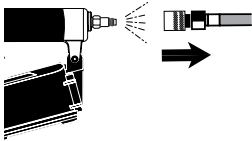
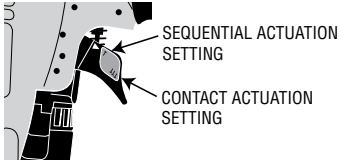
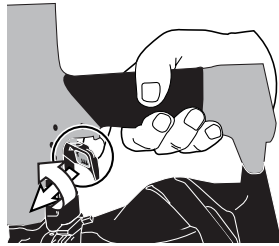
Tool Use English	Uso de la Herramienta Español	Utilisation de l'Outil Français
 <ul style="list-style-type: none"> ● With a "Contact-Actuation" (Dual-Action) trigger, nails can be driven two ways: <ul style="list-style-type: none"> a) Position workpiece contact (safety element) against work surface and pull trigger... "Trigger Fire." b) Pull trigger and push workpiece contact against work surface for operation each time the workpiece contact is pushed against the work surface. This "bottom-fire" mode of operation is preferred when high speed, rapid fastener placement is desired. 	<ul style="list-style-type: none"> ● Las herramientas con gatillo de acción doble pueden ser disparadas de dos maneras: <ul style="list-style-type: none"> a) Oprima el seguro contra la superficie de trabajo y apriete el gatillo... Disparo de gatillo. b) Para impulsar un clavo, oprima el disparador y deprima el elemento de seguridad contra la superficie de trabajo. Cada vez que deprima el elemento de seguridad contra la superficie de trabajo, impulsará un clavo. Este modo de operación de "disparo inferior" o "por rebote" es el preferido cuando se desea alta productividad y rápida colocación del clavo. 	<ul style="list-style-type: none"> ● Les appareils équipés de déclenchement "au touché / par gâchette" peuvent être utilisés de 2 façons différentes : <ul style="list-style-type: none"> a) Déclenchement par "gâchette": Appliquer le palpeur de sécurité de l'appareil à l'endroit désiré et activer la gâchette. b) Pour planter un clou, tirez sur la détente et poussez l'élément de sécurité contre la surface de travail. Chaque fois que l'élément de sécurité est poussé contre la surface de travail un clou est planté. Le mode de fonctionnement en "tir continu" est préférable si vous désirez placer des attaches rapidement avec forte productivité.
 <ul style="list-style-type: none"> ● With a "Sequential" (Restrictive) trigger, nails can only be driven one way. First depress workpiece contact (safety element) against work surface then pull trigger. This feature is helpful when precise fastener placement is required. 	<ul style="list-style-type: none"> ● Las herramientas con "Gatillo Restringido" solamente se pueden disparar con el gatillo. Primero apriete el elemento de seguridad contra la superficie de trabajo y después tire del gatillo. Ésta característica es útil cuando se requiere precisión en la colocación de los sujetadores. 	<ul style="list-style-type: none"> ● Avec une gâchette "restrictive", les clous ne peuvent être tirés que dans une seule direction. Appuyer d'abord le palpeur de sécurité sur la surface de travail, puis tirer sur la gâchette. Cette fonction est utile pour un placement précis de projectiles.
<ul style="list-style-type: none"> ● Read the "Customer Satisfaction and Safety Reminder" (CSSR) in the tool and fastener boxes for safety information regarding the Dual Action and Restrictive triggers. Under certain conditions, the Sequential trigger may reduce the possibility of injury to you or to others working with you. 	<ul style="list-style-type: none"> ● Lea el "Recordatorio de Seguridad y Satisfacción del Cliente" (CSSR) en las cajas de sujetadores y de las herramientas para información sobre seguridad de los Gatillos Restringido y de Acción Dual. Bajo ciertas condiciones, el Gatillo Restringido puede reducir la posibilidad de heridas a su persona o a otros que trabajen con usted. 	<ul style="list-style-type: none"> ● Lire le "Rappel de Sécurité et Satisfaction du Client" (CSSR) dans les boîtes à outils et fixations pour les informations de sécurité concernant les Détonnes à Double Action et à Restriction. Dans certaines circonstances, la Détonne à Restriction peut réduire la possibilité de se blesser ou de blesser d'autres personnes.
 <ul style="list-style-type: none"> ● The deflector can be rotated to change the direction of the exhaust air. 	<ul style="list-style-type: none"> ● El deflector puede rotarse para cambiar la dirección del aire expedido por el mofle. 	<ul style="list-style-type: none"> ● Le déflecteur peut être orienté différemment pour changer la direction de l'échappement d'air.
 <ul style="list-style-type: none"> ● Should a nail jam occur, disconnect air supply.  <p>Press down on the gate latch and lift open gate.</p>  <p>Extract bent nail from rear of guide body.</p>	<ul style="list-style-type: none"> ● Sise produce un atascamiento de un clavo, desconecte el suministro de aire. <p>Presione hacia abajo el pestillo de la puerta de alimentación y deje abierta la puerta de alimentación.</p> <p>Extraiga el clavo doblado desde atrás del cuerpo guía.</p>	<ul style="list-style-type: none"> ● Au cas où il se produirait un coinçage de clous, coupez l'alimentation en air. <p>Appuyer sur le verrou du volet de la chambre d'alimentation et soulever pour ouvrir.</p> <p>Extirper le mauvais clou par l'arrière du front.</p>

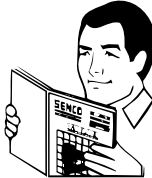
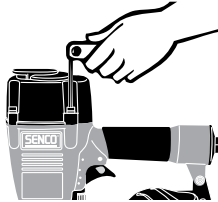
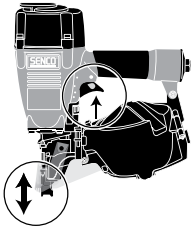

Tool Use	Uso de la Herramienta	Utilisation de l'Outil
English	Español	Français
<ul style="list-style-type: none"> ● These tools have an adjustable trigger and can be set for Contact Actuation or Sequential Actuation. <p>Press the button on the side of the tool as shown and rotate to the desired setting.</p>	<ul style="list-style-type: none"> ● Estas herramientas tienen un gatillo ajustable, y pueden configurarse para activación por contacto o activación secuencial. <p>Oprima el botón que está en el costado de la herramienta, como se muestra, y gire hasta la posición deseada.</p>	<ul style="list-style-type: none"> ● Ces outils ont une gâchette réglable et peuvent être configurés pour déclenchement par contact ou séquentiel. <p>Presser le bouton sur le côté de l'outil comme montré et le tourner sur le réglage voulu.</p>
<ul style="list-style-type: none"> ● To adjust the depth of the fastener drive, first disconnect the air supply. 	<ul style="list-style-type: none"> ● Para ajustar la profundidad de clavo o engrapado, debe primero desconectar el aire. 	<ul style="list-style-type: none"> ● Pour ajuster la profondeur à laquelle le clou est enfoncé, déconnecter tout d'abord l'appareil de la source d'air comprimé.
<ul style="list-style-type: none"> ● The Depth of Drive is set by turning the dial under the trigger. 	<ul style="list-style-type: none"> ● La profundidad de penetración se ajusta haciendo girar la ruedecilla que está debajo del gatillo. 	<ul style="list-style-type: none"> ● La profondeur d'enfoncement est fixée en tournant le cadran sous la gâchette.
<ul style="list-style-type: none"> ● Turn the dial in the direction shown for the desired setting. 	<ul style="list-style-type: none"> ● Haga girar la ruedecilla en el sentido que se muestra, hasta llegar a la posición deseada. 	<ul style="list-style-type: none"> ● Tourner le cadran dans une des directions montrées pour le réglage voulu.

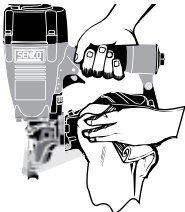
	Maintenance	Mantenimiento	Entretien
	English	Español	Français
	<ul style="list-style-type: none"> ● Read and understand "SAFETY INSTRUCTIONS" manual shipped with this tool before using tool. 	<ul style="list-style-type: none"> ● Antes de usar la herramienta lea y comprenda el manual "INSTRUCCIONES DE SEGURIDAD" despachado con ella. 	<ul style="list-style-type: none"> ● Lisez et assimilez le manuel "INSTRUCTIONS DE SÉCURITÉ" livré avec cet outil avant de l'utiliser.
	<ul style="list-style-type: none"> ● All screws should be kept tight. Loose screws result in unsafe operation and parts breakage. 	<ul style="list-style-type: none"> ● Todos los tornillos tienen que mantenerse apretados. Los tornillos sueltos pueden producir una operación no segura y quebraduras de partes. 	<ul style="list-style-type: none"> ● Toutes les vis doivent être maintenues serrées à fond. Les vis desserrées entraînent un manque de sûreté du fonctionnement et la rupture de pièces.
	<ul style="list-style-type: none"> ● With tool disconnected, make daily inspection to assure free movement of workpiece contact (safety element) and trigger. Do not use tool if safety element or trigger sticks or binds. 	<ul style="list-style-type: none"> ● Con la herramienta desconectada, haga inspecciones diarias para asegurar el movimiento libre del seguro y del gatillo. No use la herramienta si el seguro o el gatillo se atorán. 	<ul style="list-style-type: none"> ● L'outil étant séparé de l'alimentation en air, effectuez une inspection journalière pour assurer le libre mouvement du palpeur de sécurité et de la détente. N'utilisez pas l'outil si le palpeur de sécurité ou la détente colle ou se coince.
	<ul style="list-style-type: none"> ● Squirt Senco pneumatic oil (5 to 10 drops) into the air inlet twice daily. (Depending on frequency of tool use.) Other oils may damage O-rings and other tool parts. 	<ul style="list-style-type: none"> ● Aplique aceite neumático Senco en la entrada de aire dos veces al día. (Dependiendo en la frecuencia de uso 5 A 10 Gotas.) Otros aceites pueden dañar los anillos en "O" y otras piezas de la herramienta. 	<ul style="list-style-type: none"> ● Avec une burette, placer 5 à 10 gouttes d'huile pneumatique dans l'arrivée d'air deux fois par jour. (Dépend de l'intensité de l'utilisation de l'appareil.) D'autres huiles pourraient endommager les joints toriques et d'autres pièces de l'outil.
	<ul style="list-style-type: none"> ● Wipe tool clean daily and inspect for wear. Use non-flammable cleaning solutions only if necessary – DO NOT SOAK. CAUTION: Such solutions may damage O-rings and other tool parts. 	<ul style="list-style-type: none"> ● Solamente si es necesario use soluciones para limpieza no inflamables -NO LA REMOJE. Precaución: Tales soluciones pueden dañar los empaques y otras partes de la herramienta. 	<ul style="list-style-type: none"> ● Nettoyez l'outil chaque jour à l'aide d'un chiffon et inspectez-le pour déceler une éventuelle usure. Utilisez uniquement des solvants non inflammables en cas de nécessité – NE LE FAITES PAS TREMPER! Attention : De tels produits peuvent endommager les joints et d'autres pièces de l'appareil.

Troubleshooting	Identificación de Fallas	Dépannage
English	Español	Français
<p>WARNING</p> <p>Repairs other than those described here should be performed only by trained, qualified personnel. Contact SENCO for information at 1-800-543-4596.</p> <ul style="list-style-type: none"> ● Read and understand "SAFETY INSTRUCTIONS" manual shipped with this tool before using tool. 	<p>ALERTA</p> <p>Las reparaciones, fuera de aquellas descritas aquí, deben de ser llevadas a cabo solamente por personal entrenado y calificado. Póngase en contacto con SENCO para información 1-800-543-4596.</p> <ul style="list-style-type: none"> ● Antes de usar la herramienta lea y comprenda el manual "INSTRUCCIONES DE SEGURIDAD" despachado con ella. 	<p>AVERTISSEMENT</p> <p>Les réparations autres que celles décrites ici doivent être réalisées uniquement par du personnel qualifié ayant reçu la formation appropriée. Pour toute information, prenez contact avec SENCO par téléphone en appelant Le Distributeur agréé.</p> <ul style="list-style-type: none"> ● Lisez et assimilez le manuel "INSTRUCTIONS DE SÉCURITÉ" livré avec cet outil avant de l'utiliser.
<p>SYMPTOM</p> <p>Air leak near top of tool / Sluggish operation</p>	<p>SÍNTOMA</p> <p>El aire se escapa cerca de la parte superior de la herramienta / Operación lenta.</p>	<p>SYMPTÔME</p> <p>Fuite d'air près du sommet de l'outil / fonctionnement lent.</p>
<p>SOLUTION</p> <p>Verify air supply / tighten screws.</p>	<p>SOLUCIÓN</p> <p>Apriete los tornillos / Verifique el suministro de aire.</p>	<p>SOLUTION</p> <p>Serrez les vis à fond / vérifiez l'alimentation en air.</p>
<p>SYMPTOM</p> <p>Air leak near bottom of tool / Poor return.</p>	<p>SÍNTOMA</p> <p>El aire se fuga cerca de la parte inferior de la herramienta / Mal retorno.</p>	<p>SYMPTÔME</p> <p>Fuite d'air près de la base de l'outil / retour inadéquat.</p>
<p>SOLUTION</p> <p>Clean tool / tighten screws.</p>	<p>SOLUCIÓN</p> <p>Apriete los tornillos / Limpié la herramienta.</p>	<p>SOLUTION</p> <p>Serrez les vis à fond / nettoyez l'outil.</p>
<p>SYMPTOM</p> <p>Poor feed / Tool jamming.</p>	<p>SÍNTOMA</p> <p>Mala alimentación / Atascamiento de la herramienta.</p>	<p>SYMPTÔME</p> <p>Enrayage de l'outil / alimentation inadéquat.</p>
<p>SOLUTION</p> <p>Clean tool or lubricate magazine.</p>	<p>SOLUCIÓN</p> <p>Limpié la herramienta o lubrique el área de almacenamiento.</p>	<p>SOLUTION</p> <p>Nettoyez l'outil ou lubrifiez le magasin.</p>
<p>SYMPTOM</p> <p>Other problems.</p>	<p>SÍNTOMA</p> <p>Otros problemas.</p>	<p>SYMPTÔME</p> <p>Autres problèmes.</p>
<p>SOLUTION</p> <p>Contact SENCO.</p>	<p>SOLUCIÓN</p> <p>Póngase en contacto con SENCO.</p>	<p>SOLUTION</p> <p>Prenez contact avec SENCO.</p>

Specifications	Especificaciones	Specifications
English	Español	Français

SCN48 / SCN49

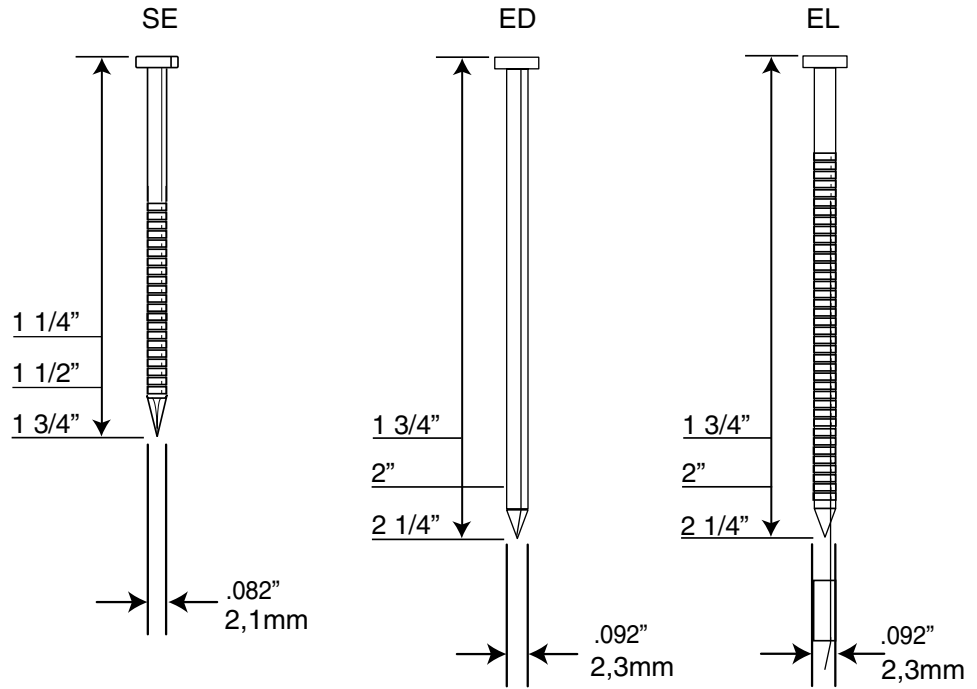

SCN49

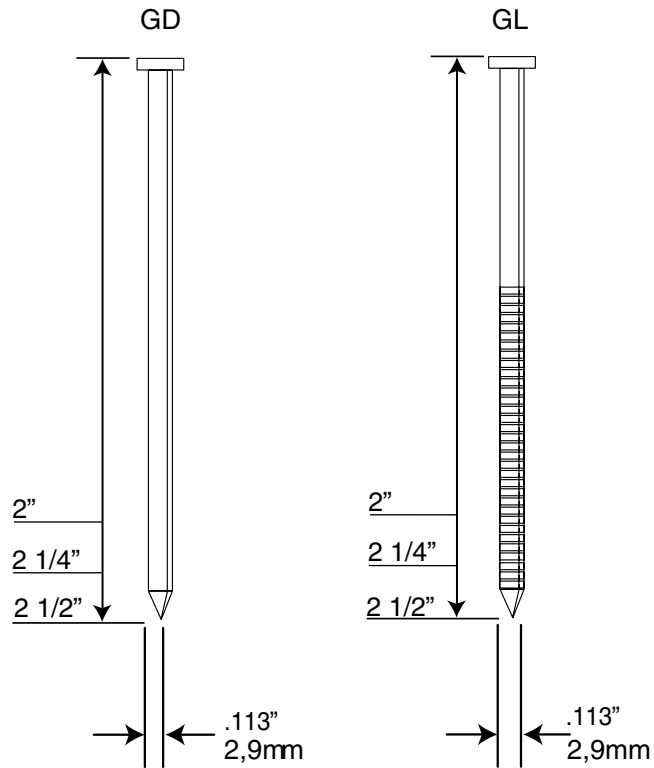

English TECHNICAL SPECIFICATIONS	SCN48		SCN49	
Min to max operating pressure	70 - 120 psi	5 - 8 bar	70 - 120 psi	5 - 8,3 bar
Air Consumption (60 cycles per minute)	2.94 scfm	83.16 liter	3.9 scfm	111 liter
Air Inlet	3/8 in. NPT	3/8 in. NPT	3/8 in. NPT	3/8 in. NPT
Maximum Speed (cycles per second)	3	3	3	3
Weight	4.3 lbs.	2.0 kg	6 lbs.	2.72 kg
Nails per Magazine Capacity	300-375	300-375	250-375	250-375
Nail Lengths	1 1/4 in. - 2 in. 1 in. - 2 in.	32 -50mm(wire) 25 - 50mm(plastic)	1 1/4 in. - 2 1/2 in.	32 -64mm
Nail Shank	.083-.092 in.	2,1-2,3mm	.083-.113 in.	2,1-2,9mm
Tool size: Height	11 1/4 in.	285 mm	12 in.	304 mm
Tool size: Length	12 in.	305 mm	12 1/4 in.	313.6 mm
Tool size: Width: Main Body	5 in.	128 mm	5 1/8 in.	132 mm

Español ESPECIFICACIONES TECNICAS	SCN48		SCN49	
Presión de operación mínima y máxima	70 - 120 psi	5 - 8 bar	70 - 120 psi	5 - 8,3 bar
Consumo de aire (60 ciclos por minuto)	2.94 scfm	83.16 liter	3.9 scfm	111 liter
Entrada de aire	3/8 in. NPT	3/8 in. NPT	3/8 in. NPT	3/8 in. NPT
Velocidad máxima (ciclos por segundo)	3	3	3	3
Peso	4.3 lbs.	2.0 kg	6 lbs.	2.72 kg
Capacidad de clavos por cargador	300-375	300-375	250-375	250-375
Longitudes de los clavos	1 1/4 in. - 2 in. 1 in. - 2 in.	32 -50mm(wire) 25 - 50mm(plastic)	1 1/4 in. - 2 1/2 in.	32 -64mm
Mango del clavo	.083-.092 in.	2,1-2,3mm	.083-.113 in.	2,1-2,9mm
Tamaño de la herramienta: Altura	11 1/4 in.	285 mm	12 in.	304 mm
Tamaño de la herramienta: Longitud	12 in.	305 mm	12 1/4 in.	313.6 mm
Tamaño de la herramienta: Ancho (Cuerpo)	5 in.	128 mm	5 1/8 in.	132 mm

Français SPECIFICATIONS TECHNIQUES	SCN48		SCN49	
Pression de travail min. et max.	70 - 120 psi	5 - 8 bar	70 - 120 psi	5 - 8,3 bar
Consommation d'air (60 cycles par minute)	2.94 scfm	83.16 liter	3.9 scfm	111 liter
Prise d'air	3/8 in. NPT	3/8 in. NPT	3/8 in. NPT	3/8 in. NPT
Vitesse maximum (cycles par seconde)	3	3	3	3
Poids	4.3 lbs.	2.0 kg	6 lbs.	2.72 kg
Capacité de clous par magasin	300-375	300-375	250-375	250-375
Dimensions des clous: longueur	1 1/4 in. - 2 in. 1 in. - 2 in.	32 -50mm(wire) 25 - 50mm(plastic)	1 1/4 in. - 2 1/2 in.	32 -64mm
Dimensions des clous: diamètre	.083-.092 in.	2,1-2,3mm	.083-.113 in.	2,1-2,9mm
Dimensions de l'outil: hauteur	11 1/4 in.	285 mm	12 in.	304 mm
Dimensions de l'outil: longueur	12 in.	305 mm	12 1/4 in.	313.6 mm
Dimensions de l'outil: largeur: corps de l'appareil	5 in.	128 mm	5 1/8 in.	132 mm

Accessories English	Accesorios Español	Accessoires Français
<p>SENCO offers a full line of accessories for your SENCO tools, including:</p> <ul style="list-style-type: none"> ● Air Compressors ● Hose ● Couplers ● Fittings ● Safety Glasses ● Pressure Gauges ● Lubricants ● Regulators ● Filters <p>For more information or a complete illustrated catalogue of SENCO accessories, ask your representative for #MK336.</p>	<p>SENCO ofrece una línea completa de Accesorios para sus herramientas SENCO, incluyendo:</p> <ul style="list-style-type: none"> ● Compresores de Aire ● Manguera ● Conectores Rapidos ● Conectores ● Anteojos De Seguridad ● Manómetros ● Lubricantes ● Reguladores ● Filtros <p>Para mas informacion ó un pour recevoir un catalogo completo ilustrado de los Accesorios SENCO, pregunte a su representante pour el numero MK336.</p>	<p>SENCO offre une gamme étendue d'accessoires pour vos outils SENCO y compris :</p> <ul style="list-style-type: none"> ● Compresseurs ● Tuyauterie flexible ● Raccords ● Lunettes de sécurité ● Manomètres ● Lubrifiants ● Régulateurs ● Filtres <p>Pour plus d'informations ou pour recevoir un catalogue détaillé des accessoires proposés par SENCO, prenez contact avec votre représentant SENCO (référence catalogue : #MK336).</p>

Limited Warranty

SENCO® Pneumatic, DuraSpin®, Cordless Tools & Compressors

Senco Products, Inc. ("SENCO") designs and constructs its products using the highest standards of material and workmanship. SENCO warrants to the original retail purchaser that the following products will be free from defects in material or workmanship for the warranty period specified below:

SENCO® XP Series-Red Cap	SENCO PRO Series	SENCO Compressors
Five years	One year	One year
SENCO® XP Series-Black Cap	SENCO DuraSpin®	SENCO Cordless
Two Years	One year	Two years
SENCO FP502	SENCO Reconditioned Products	Gas Cordless
Two Years	One Year	Two Years

During the warranty period (which begins on the purchase date), SENCO will repair or replace, at SENCO's option and expense, any product or part that is defective in materials or workmanship after examination by a SENCO Authorized Warranty Service Center, subject to the exceptions, exclusions and limitations described below. Any replacement product or part will carry a warranty for the balance of the warranty period applicable to the replaced product or part. A DATED SALES RECEIPT OR PROOF OF PURCHASE FROM THE ORIGINAL RETAIL PURCHASER IS REQUIRED TO MAKE A WARRANTY CLAIM. Product registration can be accomplished through on-line Product Registration at www.senco.com or by completing and returning the postage paid product registration form included with your Operator's manual/parts chart information, found inside the product carton. To make a warranty claim, you must return the product, with proper receipt/proof of purchase and return transportation charges prepaid, to a SENCO Authorized Warranty Service Center. A list of SENCO Authorized Warranty Service Centers can be found at www.senco.com or by calling 1-800-543-4596 toll free. SENCO will perform its obligations under this warranty, within a reasonable time after approval of the warranty claim.

Wheelbarrow Compressors:

1. Subject to the exceptions, exclusions and limitations described below, SENCO warrants that the compressor pump will be free from defects in materials and workmanship for two years after the purchase date.
2. Defective parts of the compressor pump not subject to normal wear and tear will be repaired or replaced, at SENCO's option, during the two year warranty period. If SENCO determines that repair or replacement is not feasible, SENCO will refund the purchase price less reasonable depreciation based on actual use.

SENCO Cordless:

1. Subject to the exceptions, exclusions and limitations described below, SENCO warrants that the SENCO Cordless tool will be free from defects in materials and workmanship for two years after the purchase date.
2. Subject to the exceptions, exclusions and limitations described below, SENCO warrants that the batteries and chargers used with SENCO Cordless tools will be free from defects in material and workmanship for one year after the purchase date.

WARRANTY EXCLUSIONS

The following warranty exclusions apply:

1. Normal wear parts are not covered under this warranty. Normal wear parts include, for example, isolators, drive belts, air filters, rubber o-rings, seals, driver blades, piston stops, piston/driver assembly, and fuel stems.
2. This warranty does not cover parts damaged due to normal wear, misapplication, misuse, accidents, operation at other than recommended speeds or voltage (electric units only), improper storage, or damage resulting during shipping.
3. Products used in production/industrial applications as defined by SENCO are excluded from this warranty.
4. Labor charges or loss or damage resulting from improper operation, maintenance or repairs are not covered by this warranty.
5. SENCO does not warrant the Wheelbarrow Compressor Engine/Motor, but the Compressor Engine/Motor may be covered under a warranty offered by its manufacturer.

GENERAL WARRANTY CONDITIONS

This warranty will be honored, only if:

- A. Clean, dry, regulated compressed air has been used, at air pressure not exceeding the maximum indicated on the tool casting;
- B. No evidence of abuse, abnormal conditions, accident, neglect, misuse or improper modifications or storage of the product; and
- C. No Deviation from operating instructions, specifications, and maintenance schedules exists (read Operator Manual for use, specifications, and maintenance instructions).

THIS WARRANTY IS THE ONLY WARRANTY ON THE PRODUCT, AND SENCO DISCLAIMS ALL OTHER WARRANTIES. ANY IMPLIED WARRANTIES WILL BE LIMITED IN DURATION TO THE APPLICABLE WARRANTY PERIOD SPECIFIED ABOVE. SOME STATES DO NOT ALLOW LIMITATIONS ON HOW LONG AN IMPLIED WARRANTY LASTS, SO THE ABOVE LIMITATION MAY NOT APPLY TO YOU. YOUR REMEDIES ARE SOLELY AND EXCLUSIVELY AS STATED ABOVE. SENCO SHALL IN NO EVENT BE LIABLE FOR INCIDENTAL, CONSEQUENTIAL, INDIRECT, OR SPECIAL DAMAGES. SOME STATES DO NOT ALLOW THE EXCLUSION OR LIMITATION OF INCIDENTAL OR CONSEQUENTIAL DAMAGES, SO THE ABOVE LIMITATION OR EXCLUSION MAY NOT APPLY TO YOU. IN NO EVENT, WHETHER AS A RESULT OF A BREACH OF CONTRACT, WARRANTY, TORT (INCLUDING NEGLIGENCE) OR OTHERWISE, SHALL SENCO'S LIABILITY EXCEED THE PRICE OF THE PRODUCT WHICH HAS GIVEN RISE TO THE CLAIM OR LIABILITY. ANY LIABILITY CONNECTED WITH THE USE OF THIS PRODUCT SHALL TERMINATE UPON THE EXPIRATION OF THE WARRANTY PERIOD SPECIFIED ABOVE. NO EMPLOYEE OR REPRESENTATIVE OF SENCO OR ANY DISTRIBUTOR OR DEALER IS AUTHORIZED TO MAKE ANY CHANGE OR MODIFICATION TO THIS WARRANTY.

This warranty gives you specific legal rights, and you may also have other rights which vary from state to state.

REPLACEMENT OF TOOL DUE TO NATURAL DISASTER

SENCO will replace any tool destroyed by an Act of God such as flood, earthquake, hurricane or other disaster resulting only from the forces of nature. Such a claim will be honored provided that such original retail purchaser had previously submitted a completed warranty registration card for the tool, and then submits proof of ownership and an acceptable statement describing such Act of God documented by an insurance carrier, police department, or other official governmental source. To obtain instructions for filing a claim call 1-800-543-4596.

CUSTOMER SATISFACTION

One hundred percent customer satisfaction is our #1 goal. If for any reason the product does not perform to the original purchaser's satisfaction, it can be returned to the place of purchase **within thirty days** with dated sales receipt for a full refund of the purchase price.

THIS PAGE INTENTIONALLY LEFT BLANK

THIS PAGE INTENTIONALLY LEFT BLANK