

# SEARS Kenmore

## CONTENTS

### SAFETY

..... 1-5

### USE AND CARE

Removal of Packaging Tape .....	5
Your Range and Its Features .....	6
Cooktop Cooking .....	7, 8
Cooktop Controls .....	7
Range Control .....	9
Clock & Timer .....	10
Burner Ignition .....	7, 12
Oven Cooking Tips .....	11-13
Broiling .....	14

### CLEANING

The Self-Clean Cycle .....	15, 16
Cleaning Tips .....	17, 18
Removable Range Parts .....	18-20

### SERVICE

What to Do Before Calling for Service .....	21, 22
Thermostat Adjustments .....	23

### WARRANTY

MODELS 36745, 36749

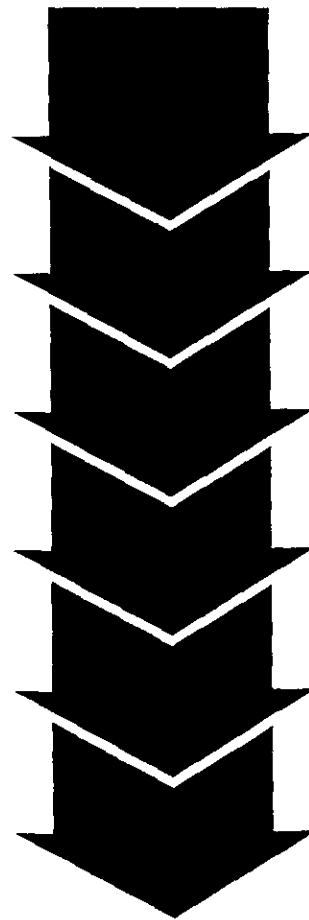

MAR 29 2000

# USE • CARE • SAFETY MANUAL



229C4020P022-1 SR10232

# STABILITY DEVICE

	<p style="text-align: center;"><b>WARNING</b></p> <ul style="list-style-type: none"> <li>• ALL RANGES CAN TIP</li> <li>• INJURY TO PERSONS COULD RESULT</li> <li>• INSTALL ANTI-TIP DEVICES PACKED WITH RANGE</li> <li>• SEE INSTALLATION INSTRUCTIONS</li> </ul>
---	---

**REMOVE ALL PARTS FROM THE PLASTIC BAG ATTACHED TO THE BACK OF THE RANGE AND SAVE PACKAGING TAPE.**

- 1) Before placing range in the counter, notice the location of the stability bracket which is already attached to the back of the range. This location should work for most installations. However, it may be more convenient to hook the stability chain to the unit when the stability bracket is attached to the upper set of holes in the back of the range (See Fig. 1). The upper set of holes are intended for use with a backsplash kit. If a backsplash kit is being used, the stability bracket can be relocated and put on at the same time as the backsplash kit. If the backsplash is not being used, make sure that there are no structural supports for the countertop which will interfere with the stability bracket when located in the upper set of holes.
- 2) Fasten one end of the stability chain to the floor or the wall with the long screw and washer supplied (See Fig. 2). Make certain the screw is going into the wall plate at the base of the wall or one of the studs in the base of the wall (See Fig. 3). Whether you attach the chain to the wall or floor, be certain that the screw is in at least 3/4" thickness of wood other than baseboard and that there are no electrical wires or plumbing in the area in which the screw could penetrate. Attach the stability chain in a location which will allow the chain to be in line with the bracket side to side as much as possible when attached to the unit. Test to see if the chain is securely fastened by tugging on the chain.
- 3) Temporarily attach the loose end of the chain to the rear of the countertop with the tape from the packaging (See Fig. 4).
- 4) Place the range in the counter cutout leaving just enough room between the back of the range and the wall to reach the stability bracket.
- 5) Hook the loose end of the chain onto the bracket by slipping the nearest link of the chain into the slot in the bracket (See Fig. 1), making sure the chain is

pulled as tight as possible and that there is no excess slack in the chain after chain is attached to the bracket.

- \* **Excess slack in the chain could allow the range to tip over.**
- 6) Slide the range all the way back into the counter. Once the range is pushed back in place, there will be a small amount of slack in the chain. This is normal.

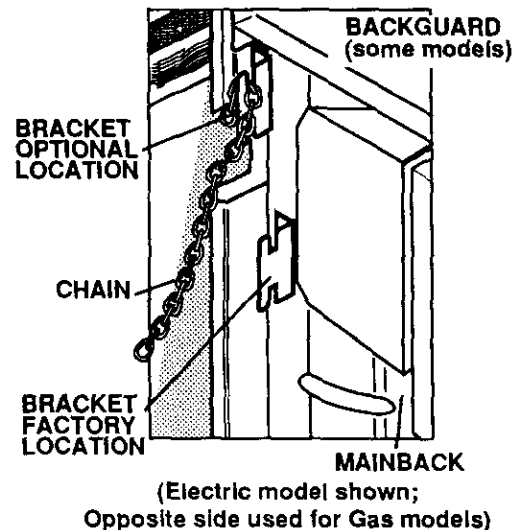

Fig. 1

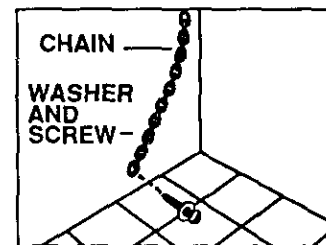

Fig. 2

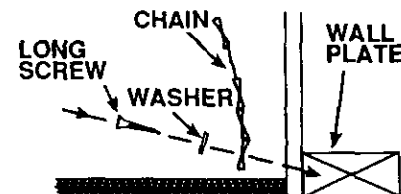

Fig. 3

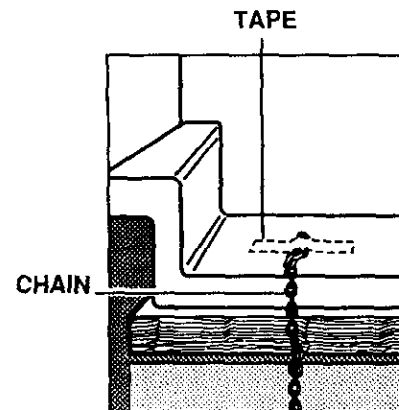

Fig. 4

IMPORTANT IMPORTANT IMPORTANT IMPORTANT IMPORTANT IMPORTANT IMPORTANT IMPORTANT IMPORTANT

# IMPORTANT INSTRUCTIONS FOR YOUR SAFETY

## SAVE THESE INSTRUCTIONS

Read all instructions before using this appliance. When using electrical appliances, basic safety precautions should be followed, including the following:

**WARNING:** If the information in this manual is not followed exactly, a fire or explosion may result causing property damage, personal injury or death.

- Do not store or use gasoline or other flammable vapors and liquids in the vicinity of this or any other appliance.
- WHAT TO DO IF YOU SMELL GAS
  - Do not try to light any appliance!
  - Do not touch any electrical switch; Do not use any phone in your building!
  - Immediately call your gas supplier from a neighbor's phone. Follow the gas supplier's instructions!
  - If you cannot reach your gas supplier, call the fire department.
- Installation and service must be performed by a qualified installer, service agency or the gas supplier.



### WARNING:

#### L. P. Burner Adjustments

The adjustments in the Installation Instructions must be made before you try to use your range.

If you are using Liquefied Petroleum Gas (bottled gas) all L. P. adjustments in the Installation Instructions must be made before use.

If your range is not properly adjusted, flames may be too high, or the range may use too much fuel, release toxic fumes or cook poorly.



Teach children not to play with control knobs or any other part of the range. Never leave children alone or unattended where a range is in use.



Never let anyone climb, sit or stand on an open oven door or any part of the range.

### WARNING:

To prevent accidental tipping of the range from abnormal usage, including excess loading of the oven door, attach it to the wall or floor by installing the anti-tip device supplied. If the range is moved for cleaning, servicing or any reason, be sure anti-tip device is re-engaged properly when the range is replaced. Failure to take this precaution could result in tipping of the range and cause injury.

IMPORTANT IMPORTANT IMPORTANT IMPORTANT IMPORTANT IMPORTANT IMPORTANT IMPORTANT IMPORTANT

To insure safety for yourself and your home, please read your Owner's Manual carefully. Keep it handy for quick easy reference. Pay close attention to the safety sections of your manual. You can recognize the safety sections by looking for the  symbol or the word "Safety".

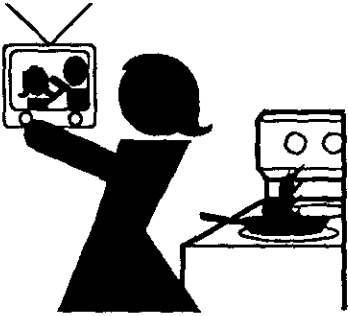

**Never** leave cooktop elements/burners unwatched at high heat settings. Boilovers cause smoking and greasy splillers could catch fire.



**Never** use a towel or other bulky cloth as a potholder. Such cloths could catch fire.

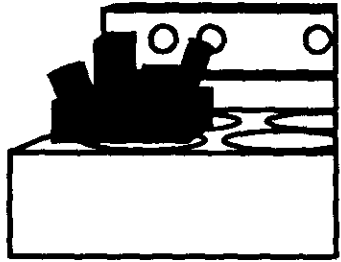

**Always** keep the range area clear and free from things that will burn.

**CAUTION:**

**Never** store things in an oven or near cooktop elements/burners. These things may catch fire and plastic items could melt.

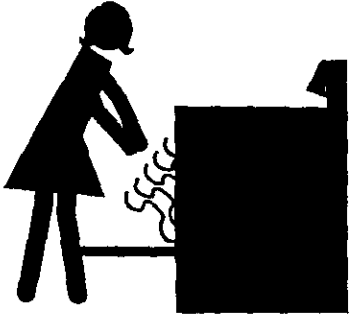

**Never** use your range for warming or heating a room. You could be burned or seriously injured. Such misuse could also cause damage to the range.

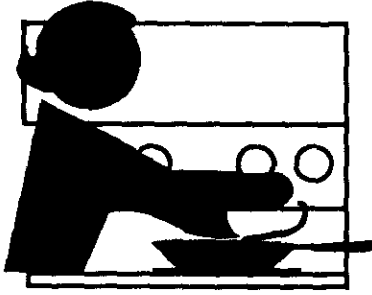

**Never** wear loose clothing when using your range. Such clothing could catch fire.



**Never** let pot handles stick out over the front of the range. Turn handles in so that they cannot be bumped. Keep the handles away from other hot surface elements/burners.



**Never** store things children might want above a range.

**CAUTION:**

**Do Not** store items of interest to children above a range or on the backguard of a range.

Children climbing on a range to reach such items could be seriously injured.

# IMPORTANT SAFETY INSTRUCTIONS

## BASIC SAFETY PRECAUTIONS

**Keep this book for later use.**

**Be sure your range is installed and grounded properly by a qualified technician.**

**Always use dry potholders when removing pans from the oven or cooktop. Moist or damp potholders can cause steam burns.**

**Always follow cleaning instructions in this book.**

**Always keep the range and oven clean. Food and grease are easy to ignite. Clean the range, oven and vents regularly.**

**Clean Only Parts Listed In Manual.**

**CAUTION: Do not store items of interest to children in cabinets above a range or on the backguard of a range. Children climbing on a range to reach items could be seriously injured.**

**Always keep combustible wall coverings, curtains, or drapes a safe distance away from your range and oven.**

**Always keep dish towels, dish cloths, potholders and other linens a safe distance away from your range. Never store such items on your range.**

**Always keep the appliance area clear and free from things that will burn (gasoline and other flammable vapors and liquids).**

**Never try to repair or replace any part of the range unless instructions are given in this book. All other work should be done by a skilled technician.**

**Never heat unopened food containers. Pressure buildup may make container burst and cause injury.**

**Never leave jars or cans of fat or drippings on or near the range. Never let grease build up on your range. You can keep grease fires from starting if you clean up grease and spills after each range use.**

**Never try to move a pan of hot fat, especially a deep fat fryer. Wait until the fat has cooled.**

**Never touch burner grates or interior surfaces of the oven. They may be hot even though there are no flames present.**

**Always keep wooden utensils, plastic utensils or canned food a safe distance away from your range.**



**Some cleaners produce noxious fumes and wet cloths or sponges could cause steam burns if used on a hot surface.**

## COOKTOP SAFETY

**Always use care when touching the cooktop burners. Cooktop burners could be hot enough to burn you even**

**if they have been turned off. The glass surface of the cooktop will retain heat after the controls are turned off.**

**Only some kinds of glass or ceramic pans can be used for cooktop cooking. Be sure that the pan you use will not break when heated on the cooktop burners.**

**Never block free airflow through the oven vent.**

**Do not cook on broken cooktop. If cooktop should break, cleaning solutions and spillovers may penetrate the broken cooktop and create a risk of electrical shock. Contact a qualified technician immediately.**



**Choose pots and pans with flat bottoms, large enough to cover the entire cooktop burner. This will cut down the risk of setting potholders or clothing on fire with an uncovered burner and waste less energy.**

## OVEN SAFETY

**Place oven racks in desired position while oven is cool. If rack must be moved while oven is hot, do not let potholder contact hot oven burners.**

**After broiling, always take the broiler pan out of the range and clean it. Leftover grease in the broiler pan can catch on fire next time you use the pan.**

**Always use care when opening oven door. Let hot air and steam escape before moving food.**

**Never use aluminum foil to line oven bottoms. Improper use of foil could start a fire.**

## SELF-CLEAN SAFETY

**If the self-cleaning mode malfunctions, turn off and disconnect the power supply. Have serviced by a qualified technician.**

**Always remove broiler pan and other utensils from the oven before a self-clean cycle.**

**Never rub, move, or damage the door gasket on self-cleaning ranges. The gasket is essential for a good seal.**

**Never try to clean utensils, cookware or removable parts of your range during a self-clean cycle.**

**Do Not Use Oven Cleaners — No commercial oven cleaner or oven liner protective coating of any kind should be used in or around any part of the oven.**

## SAFETY INSTRUCTIONS (continued)

### READ AND UNDERSTAND THIS INFORMATION NOW!

Should you ever need it, you will not have time for reading.

Be sure everyone in your home knows what to do in case of fire.

Never use water on a grease fire - it will only spread the flames.

#### COOKTOP GREASE FIRE

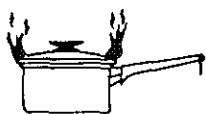

Never pick up a flaming pan...Instead:

1. Turn off the burners.
2. Smother the fire with a tightly fitting pan lid, baking soda or an extinguisher.

#### OVEN FIRE —

##### DO NOT TRY TO MOVE THE PAN!



1. Close oven door and turn controls off.
2. If fire continues, throw baking soda on the fire, or use a dry chemical, foam, or halon type extinguisher.

### IMPORTANT SAFETY NOTICE

The California Safe Drinking Water and Toxic Enforcement Act requires the governor of California to publish a list of substances known to the state to cause birth defects or other reproductive harm and requires businesses to warn customers of potential exposure to such substances.

Gas appliances can cause minor exposure to four of these substances, namely benzene, carbon monoxide, formaldehyde and soot, caused primarily by the incomplete combustion of natural gas or L.P. fuels. Properly adjusted ranges, indicated by a bluish rather than a yellow flame, will minimize incomplete combustion. Exposure to these substances can be minimized by further venting with an open window or using a ventilation fan or hood.

The range, as shipped from the factory, can only be operated with natural gas. Do not try to operate it with L.P. (bottled) gas. High flames and toxic fumes could cause serious injury. If you wish to use your range with L.P. gas, you must purchase an L.P. Conversion Kit and have it installed by a qualified installer.

#### REMOVAL OF PACKAGING TAPE:

To remove adhesive left from packing tape and ensure you do not damage the finish of your new appliance, use an application of household liquid dish washing detergent, mineral oil, or cooking oil. Apply with soft cloth and allow to soak. Wipe with soft cloth. DO NOT use plastic pad or equivalent. Wipe dry and then apply an appliance polish to thoroughly clean and protect the surface. This procedure is also safe for the face of microwave doors and other plastic parts.

**NOTE: The plastic tape must be removed from chrome trim on range parts. It CANNOT be removed if baked on.**

#### WHERE CAN YOU LOOK FOR PACKAGING TAPE?

- Elements/burners
- Drip pans
- Control panel: top, sides, and bottom
- Under maintop
- Door trim: top, sides, and bottom
- Oven bottom
- Door handles

# YOUR RANGE

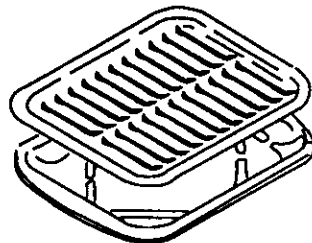
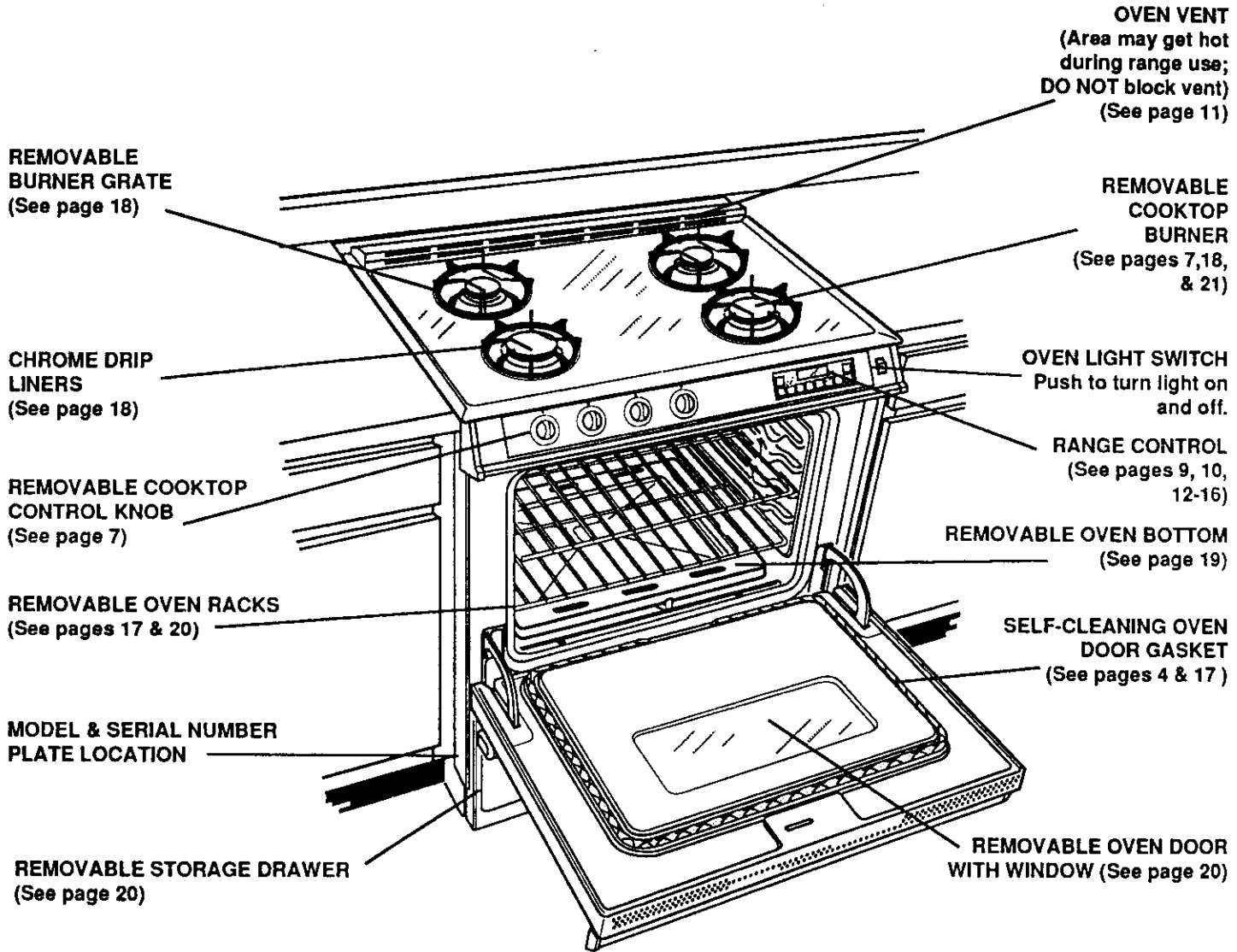

**BROILER PAN & GRID**  
(See pages 14 & 18)

## TO START THINGS COOKING COOKTOP COOKING

Before you use the cooktop for the first time, take a few moments to familiarize yourself with the burners and the knob used to turn on each burner.

COOKTOP BURNERS

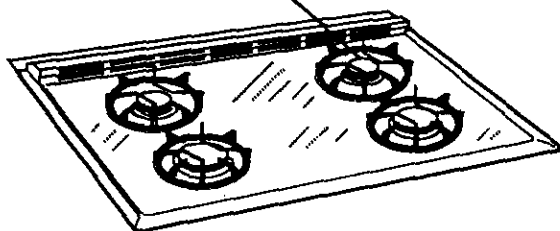

The sign near each cooktop control knob shows which burner is turned on by that knob.

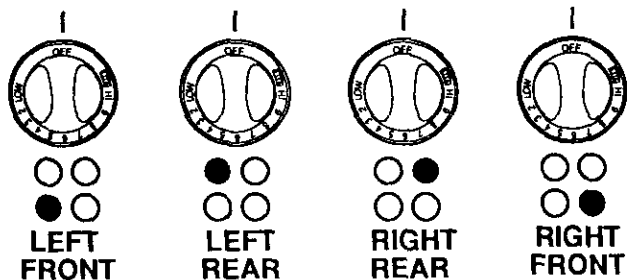

To operate cooktop controls:

1. Push to turn.

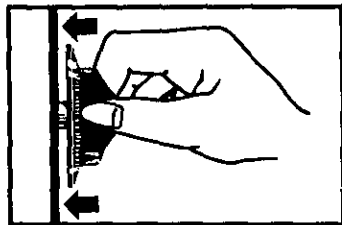

2. Push to turn knobs to LITE position. After the burner ignites, the ticking sound of the spark will stop. Set knob to desired flame setting.

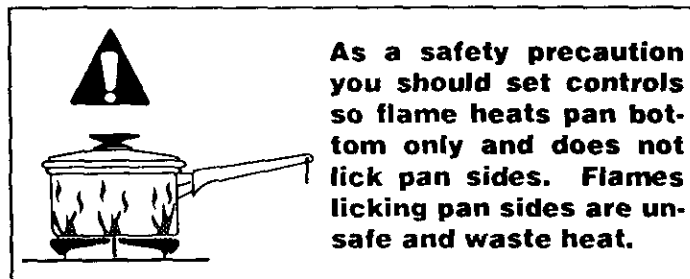
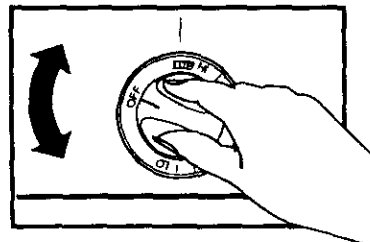

Avoid leaving any burner on without a utensil. Doing so can overheat the grate and cause the enamel finish of the grate to become damaged.

## BURNER IGNITION

**COOKTOP SPARK IGNITION** - When you turn the cooktop knob to LITE, the spark igniter makes a series of electric sparks (ticking sound) which lights the burner.

During a power failure the burners will not light automatically. In an emergency, a cooktop burner may be lit with a match by following the steps below. The oven cannot be used during a power failure.



**Lighting gas burners with a match is dangerous. You should match light the cooktop burners only in emergency.**

1. Light a match and hold the flame near the burner you want to light. Wooden matches work best.
2. Push in and turn the control knob slowly. Be sure you are turning the correct knob for the burner you are lighting.

### NOTE:

If the burner does not light within five seconds, turn the knob off and wait five minutes before trying again.



**During burner use, the area of the glass cooktop around the burners could get hot. Use caution.**

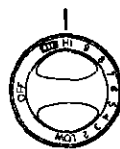

**High flame** may be used to boil large quantities quickly. It is also used to start food cooking quickly in large pans.

Watch foods when heating them quickly on HI. As soon as the food reaches cooking temperature, turn down the heat to the lowest setting that will keep it cooking.

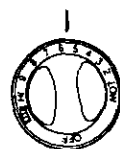

**Medium flame** may be used for even browning with little spattering. It is also used to maintain a boil with large quantities of food.

**Low flame** may be used for melting or warming food. It is also best for cooking small quantities of food.



The lowest setting of the burner has a very small flame to provide simmering capability. To simmer foods, set the cooktop control knob to the lowest setting that will maintain the desired simmer. If simmering on one burner and other burners are turned on, the gas flow of the simmering burner

may have to be adjusted.

If your simmering burner goes out when the other burners are on, adjust the simmering burner control knob until burner re-ignites. After re-ignition, set cooktop control knob to the lowest setting that will retain a flame on the burner.



## To Start Things Cooking (cont.)

For best cooking results and energy efficient operation, you should use pans that are flat on the bottom. Match the size of the pan to the size of the flame. The pan should not extend over the edge of the drip bowl more than 1".



**Note:** A slight odor is normal when a new cooktop is used for the first time. It is caused by the heating of new parts and insulating materials and will disappear in a short time.

## WOK COOKING

We recommend that you use only a flat-bottom wok. They are available at your local retail store.

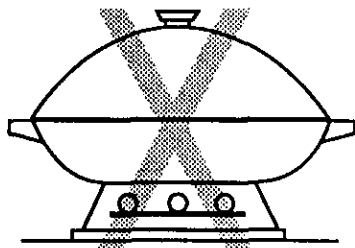
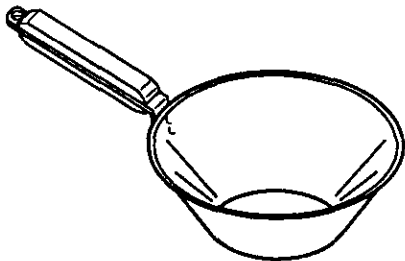

Do not use woks which have support rings. Use of these types of woks, with or without the ring in place, can be dangerous. Placing the ring over the burner grate may damage the burner grate and burner head. Also, placing the ring over the burner grate may cause the burner to work improperly, resulting in carbon monoxide levels above allowable current standards. This could be dangerous to your health. See the Safety Section of this manual. Do not try to use such woks without the ring. You could be seriously burned if the wok tipped over.

## HOME CANNING TIPS

In surface cooking of foods other than canning, the use of large-diameter pots (extending more than 1" beyond edge of drip pan) is not recommended. However, when canning with water-bath or pressure canner, large-diameter pots may be used. This is because boiling water temperatures (even under pressure) are not harmful to cooktop surfaces surrounding burner.

**HOWEVER, DO NOT USE LARGE DIAMETER CANNERS OR OTHER LARGE DIAMETER POTS FOR FRYING OR BOILING FOODS OTHER THAN WATER.**

Most syrup or sauce mixtures — and all types of frying — cook at temperatures much higher than boiling water. Such temperatures could eventually harm cooktop surfaces surrounding burners.

## OBSERVE FOLLOWING POINTS IN CANNING

1. Bring water to boil on HIGH heat, then after boiling has begun, adjust heat to lowest setting to maintain boil (saves energy and best uses surface unit).
2. Be sure canner fits over center of cooktop burners. If your range does not allow canner to be centered on burner, use smaller-diameter pots for good canning results.
3. Flat-bottomed canners give best canning results. Be sure bottom of canner is flat or slight indentation fits snugly over burner. Canners with flanged or rippled bottoms (often found in enamelware) are not recommended.

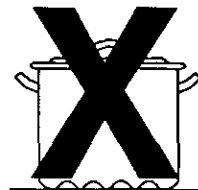

4. When canning, use recipes from reputable sources. Reliable recipes are available from the manufacturer of your canner; manufacturers of glass jars for canning, such as Ball and Kerr; and the United States Department of Agriculture Extension Service.
5. Remember, in following the recipes, that canning is a process that generates large amounts of steam. Be careful while canning to prevent burns from steam or heat.

# RANGE CONTROL

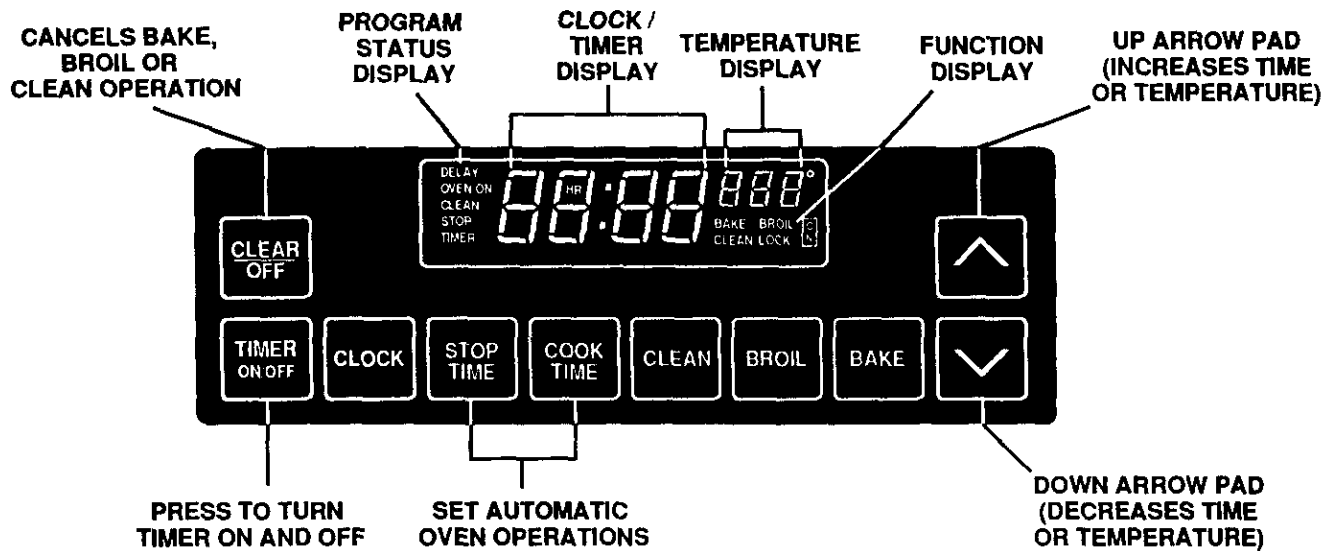

Your range is controlled with a touch. You now have the ease of setting the following operations:

- |                    |                   |
|--------------------|-------------------|
| <b>CLOCK</b>       | <b>TIMER</b>      |
| <b>BAKE</b>        | <b>DELAY BAKE</b> |
| <b>BROIL</b>       | <b>CLEAN</b>      |
| <b>DELAY CLEAN</b> |                   |

The **UP** or **DOWN** arrow is used to set an amount of time or change the temperature you want to use. By pressing and holding down either pad the numbering will change quickly. By pressing and releasing either pad the numbering will change slowly.



## DISPLAY:

Once you have programmed your control for any operation, you can display the setting by pressing the appropriate pad. For example, if you are using the **TIMER** and want to see the time of day, press **CLOCK**. The display will show the time of day.



**NOTE:** You cannot set **BAKE**, **BROIL** or **COOK TIME** while the oven door is in the locked position. If you try, the word **"DOOR"** will appear in the display. The oven door lock is to be used for **Self-Cleaning** only.

## TONES:

The end-of-cycle tone will sound at the end of timer use and automatic oven functions. The end-of-cycle tone is 3 short beeps followed by 1 beep every 6 seconds that repeat until you press any operation. To cancel the end-of-cycle tone, press any key except the **UP** or **DOWN** arrow key. If you would like to eliminate the repeating beeps, push and hold **CLEAR/OFF** for ten seconds. To return the 1 beep every 6 seconds, push and hold **CLEAR/OFF** for 10 seconds.

## F-CODE:

If the time display beeps continuously and flashes an **"F"** followed by a number, you have a function error code. Note the number after the **"F"**. Press **CLEAR/OFF**. Allow oven to cool for 1 hour. If problem repeats, disconnect all power to the range and call for service. Advise your service technician of the number following the **"F"** in the display.

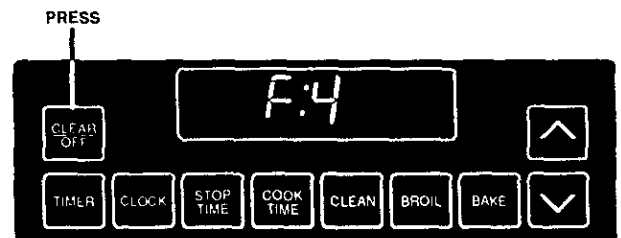

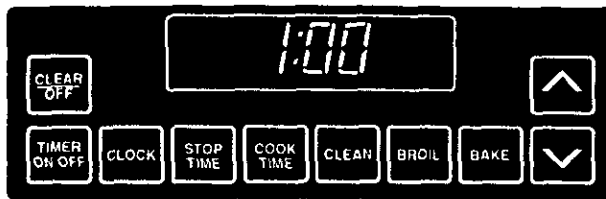

## TO SET THE CLOCK:

CLOCK

1. Press the **CLOCK** pad. “**SET**” and “**TIME**” will show in the display.
2. Press either the **UP** or **DOWN** arrow pad, until the display shows the correct time of day.

The **UP** arrow will change numbering forward, such as 1, 2, 3. The **DOWN** arrow will change numbering backwards, such as 3, 2, 1.

**The clock will automatically start within one minute; or you may press the clock pad for immediate start.**

## TO SET THE TIMER:

The timer does not control oven operations, such as bake, broil, clean or any delay function. It allows you to set an amount of time and alerts you when that time is up. An example would be timing a three minute egg. The maximum amount of time you may set is 9 hours and 55 minutes.

TIMER  
ON/OFF

1. Press the **TIMER ON/OFF** pad. “**SET**” and “**TIMER**” will flash and “**HR**” will show in the display.
2. Press either the **UP** or **DOWN** arrow pad to set the amount of time you want.

The timer will automatically start to count down within 4 seconds.

CLOCK

3. When the timer counts down to zero a tone will sound. Press the **CLOCK** pad to return to the current time of day.

## TO RESET THE TIMER:

When you are setting the timer, if you pause more than 4 seconds while pressing either the **UP** or **DOWN** arrow pad, “**TIMER**” will stop flashing in the display and the timer will automatically start to count down. If this should happen just press the **TIMER ON/OFF** pad and you will be able to continue setting your time.

TIMER  
ON/OFF

## TO CANCEL THE TIMER:

While the timer is counting down, press and hold down the **TIMER ON/OFF** pad for 4 seconds, or until “**TIMER**” quits flashing and the current time of day returns to the display.

# OVEN COOKING

## GENERAL RULES

- When cooking a food for the first time in your new oven, use time given on recipes as a guide.  
Your new oven has been set correctly at the factory and is apt to be more accurate than the oven it replaced.  
After you have used your oven for awhile, if you feel your oven should be hotter or cooler, you can adjust it yourself. See **TEMPERATURE ADJUSTMENTS** in this manual.
- **NO PEEKING** — Opening the door too often to check food during baking will allow heat loss and may cause poor baking results.
- There may be some odor when the oven is first used. This is caused by the heating of new parts and insulation.
- Do not cover an entire oven rack with foil. The foil can block normal heat flow and cause poor baking results. Do not place any foil directly on the oven bottom. Foil used on the oven bottom under the element may damage the oven surface, therefore, it should not be used.

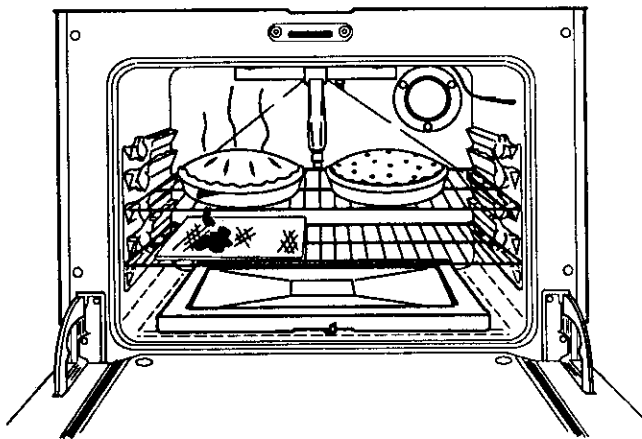

## MOISTURE

As your oven heats up, the temperature change of the air in the oven may cause water droplets to form on the door or door glass. To prevent this, open the oven door for the first minute of oven heating to let the moist air escape.

## OVEN VENT

When the oven is on, heated air moves through a vent behind the cooktop. On the cooktop, this hot air may make pot handles hot or melt plastic items left too near the vent.

The vent is necessary for proper air circulation in the oven and good baking results. **Do not block this vent. Doing so may cause cooking failure, fire or damage to the range.**

OVEN VENT AREA

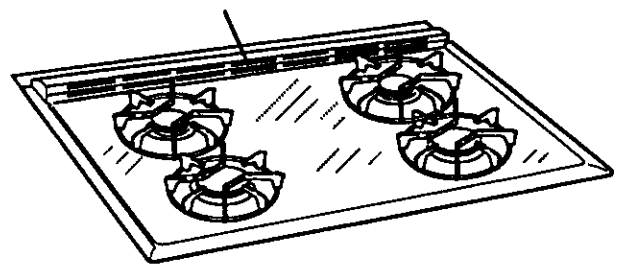

## PREHEATING

- When recipes require preheating, have food nearby before you open the oven door. If the oven door is allowed to remain open for more than a brief time, the preheat temperature will be lost.
- Let the oven preheat thoroughly before cooking baked products. If your range is equipped with a **Preheat Indicator Light**, watch for it to come on and put the food in the oven. If not, preheat for 10 minutes before putting food in the oven.

## BAKEWARE

- Cookies should be baked on flat cookie sheets without sides to allow the air to circulate properly.

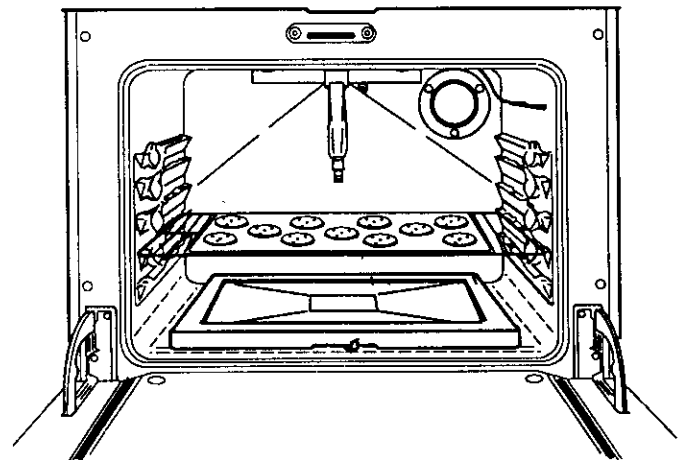

- Cakes, muffins, and quick breads should be baked in shiny pans — to reflect the heat — because they should have a light golden crust. Yeast breads and pie crusts should be baked in glass or dull (non-shiny) pans — to absorb the heat — because they should have a brown, crisp crust.
- Be sure the underside of the pan is shiny, too. Darkened undersides will absorb the heat and may cause over-browning on the bottom of your food.
- Oven temperatures should be reduced 25 degrees below recommended temperatures if exterior of pan is predarkened, darkened by age or oven proof glass.

## BAKING:

- Always follow recipe carefully.
- Measure ingredients properly.
- Use proper pan and rack placement to obtain the best cooking results.

### NOTE:

The top position is only a guide. It cannot be used as a rack position.

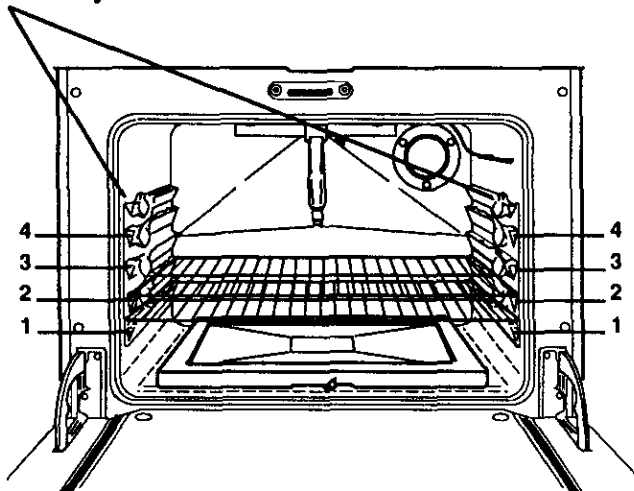

- Place pans on the oven racks with 1" to 1 1/2" of air space on all sides of each pan. Avoid overcrowding the oven.

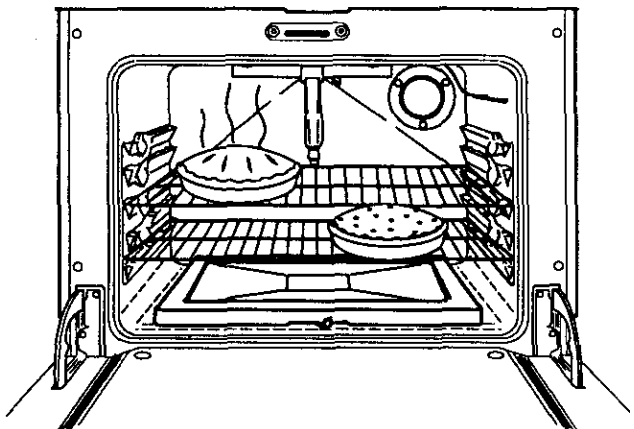

- When baking several items, stagger pans so that no pan is directly above another.
- Pans too close to each other, to oven walls or to the oven bottom block the free movement of air. Improper air movement causes uneven browning and cooking.

## TO SET BAKE:

BAKE

1. Press the **BAKE** pad.
2. Press either the **UP** or **DOWN** arrow pad. The last temperature used will show in the display. Use the **UP** arrow pad to increase this temperature or the **DOWN** arrow pad to decrease this temperature until you reach the temperature you prefer to use.

The oven will start to heat automatically. You will see 100 degrees showing in the upper right corner of the display. As the oven heats this temperature will change until it reaches your selected temperature, then a tone will sound.

CLEAR  
OFF

3. When baking is complete, press the **CLEAR/OFF** pad.

**OVEN GLOW BAR IGNITION** - When you turn the Oven Control on, the glow bar igniter begins to heat. When the igniter is hot enough, in about 1 minute, the gas flows into the burner and is ignited.

The igniter glows bright orange when hot. It cycles on and off with the thermostat and will glow whenever the burner is on.



During a power failure the oven burner cannot be lit and you should not try to do so.

You may hear a fan. This is normal. The fan may continue to run after oven has been turned off.

## TIMED BAKING:

### TO SET YOUR OVEN TO BAKE FOR A SET AMOUNT OF TIME AND TURN OFF AUTOMATICALLY.

BAKE

1. Press the **BAKE** pad.
2. Press either the **UP** or **DOWN** arrow pad, to set the temperature you want to use.

COOK  
TIME

3. Press the **COOK TIME** pad.
4. Press either the **UP** or **DOWN** arrow pad, to set the amount of time you want foods to cook. Be sure you include your preheat time when setting this amount of time.

If you pause between steps when you are setting this function, the control will beep. This is normal. The control is letting you know you need to continue.

You should consider that food will continue to cook after control turns OFF unless you remove the food immediately.



The low temperature zone of this range (between 170°F and 200°F) is available to keep hot cooked foods warm. Food kept longer than two hours at these low temperatures may spoil.

## TO SET YOUR OVEN FOR A DELAYED START AND AUTOMATIC STOP

While setting this operation you will not need to calculate when the oven will turn on; the control will do this for you. You will need to set the following:

1. Temperature
2. Cooking Time
3. Stop Time

**BAKE**

1. Press the **BAKE** pad.
2. Press the **UP** or **DOWN** arrow pad to select the temperature you want.

**COOK TIME**

3. Press the **COOK TIME** pad.
4. Press the **UP** arrow to select how long you want food to cook. **Be sure to include your preheat time.**

**STOP TIME**

5. Press the **STOP TIME** pad.
6. Press the **UP** arrow pad to enter the time of day you want the oven to turn off. The oven will shut off automatically when the preset **STOP TIME** is reached.

**CLOCK**

7. Press the **CLOCK** pad to return the display to the current time of day.

If you pause between steps when you are setting this function, the control will beep. This is normal. The control is letting you know that you need to continue.

If you want to cancel the setting of this function, press the **CLEAR/OFF** pad.

**CLEAR  
OFF**



Never let food, such as dairy products, fish, poultry, etc., sit for more than 1 hour before cooking starts when you set your oven for a delay start. Room temperature promotes the growth of harmful bacteria. Be sure the oven light is off because heat from the bulb will speed bacterial growth.

## ROASTING

Roasting is cooking tender cuts of meats with dry air. It is not necessary to preheat your oven before roasting.

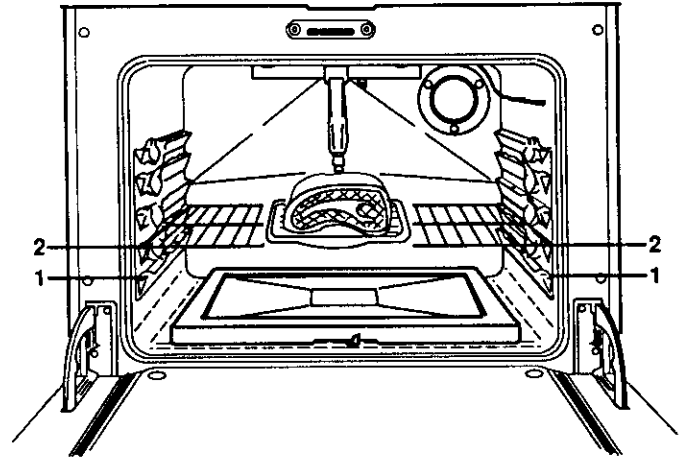

### GENERAL ROASTING INSTRUCTIONS

1. Place pan in No.1 or No. 2 rack position.
2. Press the Bake pad.

**BAKE**

3. Press the **UP** or **DOWN** arrow pad to select the temperature you need.



4. When roasting is finished, press the **CLEAR/OFF** pad.

**CLEAR  
OFF**

### Remember:

Most meats continue to cook internally after being taken out of the oven.

# BROILING

## BROILING TIPS:

**Please note:**

**Your oven door should be completely closed while broiling.**

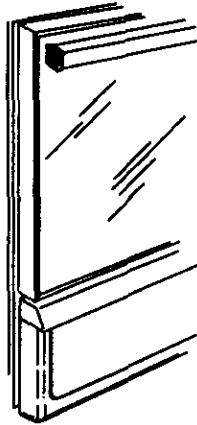

- Use only the broiler pan and grid that came with your range for broiling. They are designed for proper drainage of fat and liquids and help prevent spatter, smoke or fire.
- **Do not preheat when broiling.** For even broiling on both sides, start the food on a cold pan.
- Trim the outer layer of fat from steaks and chops. Slit the fatty edges to keep the meat from curling.
- For maximum juiciness, salt the first side just before turning the meat. Salt the second side just before serving.
- Brush chicken and fish with butter several times as they broil. When broiling fish, grease the grid to prevent sticking. Broil with skin side down. It is not necessary to turn fish.
- **Never leave a soiled broiler pan in the range.** Grease in the pan may smoke or burn the next time the oven is used.
- Be sure you know the correct procedure for putting out a grease fire. **See the section on safety.**



**CAUTION:**

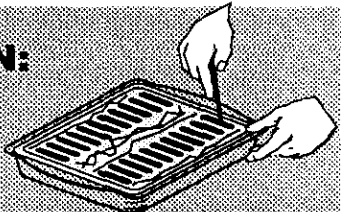

**Do not cover the entire broiler grid with a solid strip of foil. Instead mold foil tightly to grid and cut slits in foil to align with slits in the grid. Poor drainage of hot fat may cause a broiler fire.**

**If a fire starts, close the oven door and turn controls OFF. If fire continues, throw baking soda on the fire. Do not put water on the fire.**

## POSITIONING BROILER PAN

Broiling is cooking by direct heat from the broil burner. Tender cuts of meat or marinated meat should be selected for broiling. For best results, steaks and chops should be at least 3/4" thick.

After placing food on the broiler pan and grid, put the pan on an oven rack in the proper position. The recommended rack position and cooking time can be found in the chart below.

The closer the food is to the broil burner, the faster the meat browns on the outside, yet stays red to pink in the center. Moving the meat farther away from the burner lets the meat cook to the center while browning outside. Side one should be cooked 1 - 2 minutes longer than side two.

Food	Rack Position 4 = Highest 1 = Lowest	Total Time (minutes)
Steak – 1" Thick	Rare	9-11
	Medium	13-15
	Well Done	21-23
Ground Beef Patties	Medium-1" Thick	16-18
	Medium-1/2" Thick	7-9
Lamb Chops – 1" Thick	3	18-21
Pork Chops – 1" Thick	3	27-29
Pork Chops - 1/2" Thick	3	16-18
Ham Slice – 1/2" Thick	3	11-12
Fish (Fillets)	3	11-13
Chicken (Pieces)	2	45-55
Frankfurters	3	8-11
Bacon	3	9-11

This chart is a general guide. The size, weight, thickness, and starting temperature of the food, as well as your own personal preference, will affect the cooking time. Times in the chart are based on the food being at refrigerator temperature. The U.S. Department of Agriculture notes that meats cooked rare are popular, but cooking meat to only 140°F may allow some poisoning organisms to survive.

## TO SET BROIL:



1. Press the **BROIL** pad.
2. Press the **UP** arrow pad once to select **LO BROIL**.

3. Press the **UP** arrow pad twice to select **HI BROIL**. "BROIL" and either "HI" or "LO" will show in the upper right corner of the display depending on your choice.

**NOTE:** Use **LO** broil to cook foods such as poultry or thick cuts of meat thoroughly without over-browning them.

If you do not press the up or down arrow pad, the display will go blank and you must repeat Steps 1 and 2.



4. When broiling is finished, press the **CLEAR/OFF** pad.

# THE SELF-CLEAN CYCLE (3 HOURS - NORMAL CLEAN TIME)

## BEFORE A CLEAN CYCLE

1. Remove the broiler pan and grid, oven racks, all utensils and any foil that may be in the oven. Do not try to clean utensils or any other objects in the oven during a self-clean cycle. **If oven racks are left in the range during a clean cycle, they will darken, lose their luster and become hard to slide. If you choose to leave the racks in the oven, you can polish the edges of the racks with steel wool and apply a small amount of vegetable oil to the rack edges after the self-clean cycle. This will make the racks easier to slide.**

2. Soil on the oven front frame, under the front edge of the cooktop, the door liner outside the door gasket and the front edge of the oven cavity (about 1" into the oven) will not be cleaned during a clean cycle (see illustration below). Clean these areas by hand before starting a clean cycle.

Use hot water with a soap-filled steel wool pad. We recommend a cleanser such as 'Soft Scrub®' brand or a similar cleaning product to keep white surfaces looking clean and new. After cleaning, rinse well to help prevent a brown residue from forming when the oven is heated. Buff these areas dry with a dry cloth.

## OVEN LIGHT

To prolong the life of the bulb, be sure the oven light is **OFF** during Self-Clean.

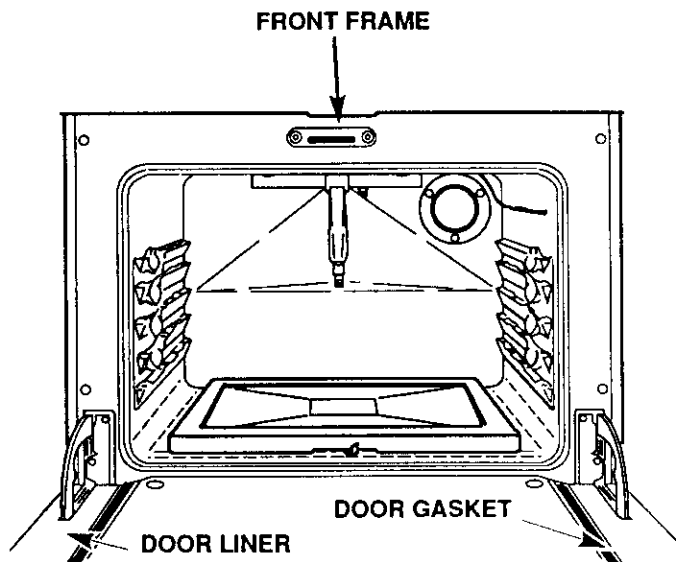

3. Wipe up heavy spillovers on the oven bottom. Too much soil may cause smoking during the clean cycle.
4. Do not rub the door gasket. The fiberglass material of the gasket has an extremely low resistance to abrasion. An intact and well fitting oven door gasket is essential for energy efficient oven operation and good baking results. If you notice the gasket becoming worn, frayed or damaged in any way or if it has become displaced on the door, you should replace the seal.

## Please Note:

The door gasket is designed to have a 5"-6" gap at the bottom of the oven door. This is to allow for proper air circulation.

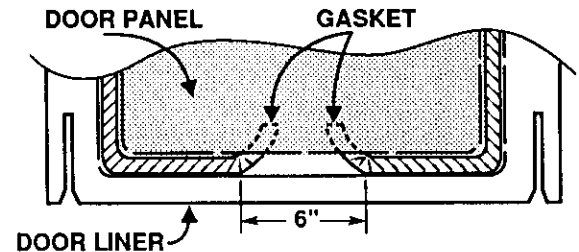

## TO SET A SELF-CLEAN CYCLE:

1. Push the **CLEAN** pad. The display will show "CLEAN", "TIME", and (----).

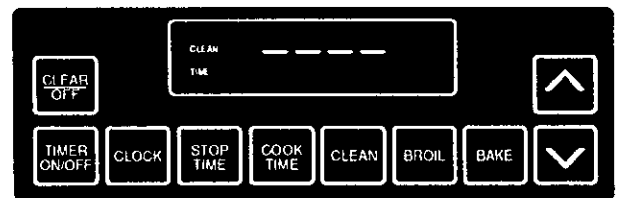

2. Press the **UP** or **DOWN** arrow pad to select the amount of time you want the oven to clean. The normal cycle is 3 hours, but you can choose between 2 and 4 hours.



You can press the **STOP TIME** pad to see the time of day the clean cycle will be finished. Push the **CLEAN** pad to return to the countdown.

(Self-Clean continued on next page. . .)



(Self-Clean continued. . .)

## WHEN A CLEAN CYCLE IS FINISHED:

1. Wait until the **LOCK** display goes out. The oven temperature must drop to a safe level before the door can be unlocked.



## TO INTERRUPT A CLEAN CYCLE:

1. Push **CLEAR/OFF**.



Follow instructions under **“WHEN A CLEAN CYCLE IS FINISHED.”**

## TO SET A DELAYED SELF-CLEAN CYCLE:

You will not need to determine when the oven will turn on, when setting this function. The control will do this for you. You will need to set the amount of time you want your oven to clean (between 2 and 4 hours), and the time of day when you want the oven to turn off.

**CLEAN**

1. Press the **CLEAN** pad. The display will show **“CLEAN”, “TIME”** and (---).
2. Press either the **UP** or **DOWN** arrow pad to select the amount of time you want the oven to clean. The normal cycle is 3 hours but you may choose between 2 and 4 hours.

**STOP TIME**

3. Press the **STOP TIME** pad.
4. Press either the **UP** or **DOWN** arrow pad to select the time of day you want the cycle to end and the oven to turn off.

Make sure your oven light is off during a self-clean cycle to prolong the life of the bulb.

## AFTER A CLEAN CYCLE

After a clean cycle, you may notice some white ash in the oven. Just wipe it up with a damp cloth or sponge.

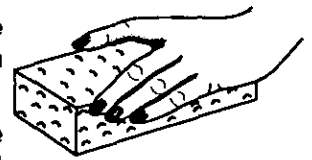

If white spots remain, remove them with a soap-filled steel wool pad. Be sure to rinse thoroughly with a vinegar and water mixture. These deposits are usually a salt residue that cannot be removed by the clean cycle.

If the oven is not clean after one clean cycle, the cycle may be repeated.

## QUESTIONS AND ANSWERS

- Q. If my range control is not working, can I still self-clean my oven?  
A. No. Your **RANGE CONTROL** is used to program the oven to start and stop the self-cleaning cycle.
- Q. Can I use commercial oven cleaners on any part of my self-cleaning oven?  
A. No cleaners or coatings should be used on or around any part of this oven.
- Q. Can I clean the woven gasket around the oven door?  
A. You cannot clean the woven gasket.
- Q. Is it normal to hear “crackling sound” during cleaning?  
A. Yes. This is the metal heating and cooling.
- Q. Why do I have ash left in my oven after cleaning?  
A. Some types of soil will leave a deposit. It can be removed with a damp sponge or cloth.
- Q. What should I do if excessive smoking occurs during cleaning?  
A. This is caused by excessive soil and you should press **CLEAR/OFF**. Open windows to rid room of smoke. Allow the oven to cool for at least one hour before opening the door. Wipe up excess soil and reset the clean cycle.
- Q. Should there be any odor during the cleaning?  
A. Yes, there may be an odor during the first few cleanings. Failure to wipe out excessive soil might also cause an odor when cleaning.

# CLEANING TIPS

On the following pages, all removable parts on your range are shown. Refer to those pages when cleaning your range. Warm water, a mild detergent and a soft cloth are safe to use on all cleanable parts of your range.

Do not use metal scouring pads, except where recommended.

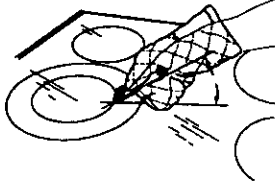
PART	CLEANING MATERIALS	REMARKS
<b>CONTROL PANEL, KNOBS</b>	All-purpose, non-abrasive cleaner, warm water, soft cloth	Do not scour. Knobs pull off for easier cleaning.
<b>BURNER BOWLS, GRATES, TOPS, TRIM RINGS</b>	Detergent, warm water and/or soap-filled steel wool pad  <div style="border: 1px solid black; padding: 5px; display: inline-block;">  <b>Do not use cooktop burners unless burner tops are in place.</b> </div>	See next page for information on removable burner tops. Soak stubborn soil. Rinse and dry completely. Take care not to catch cleaning cloths on spark igniter when burner tops are removed. Leave burner caps in place when cleaning burner bowls.
<b>GLASS</b>	Single-edged razor scraper, Sears Cooktop Cleaning Creme® (Stock No. 40079, available at Sears, Roebuck and Co.) or other all-purpose, non-abrasive cleaner  <b>Note:</b> If you need additional cleaning to eliminate spotting, wash with equal parts white vinegar and warm water; Rinse well and dry  	Wipe surface clean after each use. We recommend regular cleaning with Sears Cooktop Cleaning Creme®. Do not use a dishtowel or sponge to wipe up the cooktop. They may leave a film of detergent which can discolor your cooktop when heated. You should use paper towels or a clean cloth which is used only for cooktop cleaning. Remove burned-on spillovers with razor scraper. Hold the scraper at a 30° angle to the cooktop and scrape off spot. <b>NEVER USE ABRASIVE SCOURING PADS OR POWDERS ON COOKTOP.</b> Plastic mesh pads such as Dobbie® may be used.
<b>OVEN INTERIOR</b>	Detergent, warm water and/or soap-filled steel wool pad; Do not use oven cleaner in or around any part of the oven	Cleaning inside the oven need only be done as an optional touch-up between self-clean cycles. Rinse oven interior thoroughly after cleaning.
<b>OVEN DOOR GASKET</b>	DO NOT CLEAN	Do not clean the door gasket. The fiberglass material of the gasket has an extremely low resistance to abrasion. An intact and well-fitting oven door gasket is essential for energy efficient oven operation and good baking results. If you notice the gasket becoming worn, frayed or damaged in any way, or if it has become displaced on the door, you should have it replaced.
<b>OVEN RACKS</b>	Detergent, warm water and/or soap-filled steel wool pad	Remove from oven to clean. Rinse thoroughly.

# CLEANING TIPS

PART	CLEANING MATERIALS	REMARKS
<b>BRUSHED CHROME COOKTOP</b>	Detergent, warm water, plastic or nylon scouring pad or boil in Dip-It® solution to remove stubborn soil	Do not scour chrome tops. Stubborn stains may be removed by using Espree Magwheel Cleaner® or Turtle Wax Polishing Compound®. To remove finger prints on brushed chrome, apply a little baby oil with a paper towel. Rub in the direction of the brush marks. Armor All Protectant® can also be used (after cleaning). Be sure to clean spills of acidic foods quickly. Vinegar spills can permanently stain chrome.
<b>GLASS OVEN DOOR/WINDOW (SOME MODELS)</b>	Glass cleaner and paper towels	Remove stubborn soil with paste of baking soda and water. Do not use abrasive cleaners. Rinse thoroughly.
<b>BROILER PAN AND GRID</b>	Detergent, warm water, soft cloth or a chrome cleaner or special cooktop cleaning creme	Remove soiled pan from oven to cool. Drain fat or drippings. Fill pan with warm water. Sprinkle grid with detergent and cover with damp cloth or paper towels. Let pan and grid soak for a few minutes. Rinse or scour as needed. Dry well. Grid and pan may be washed in a dishwasher.

## REMOVABLE COOKTOP BURNER COMPONENTS

Be sure that all controls are turned off and that the unit is cool.

### To remove:

Lift off burner grate, burner top and trim ring. Do not remove burner bowl.

See the Cleaning Tips Chart in this manual. Be sure to dry burner tops completely before re-assembling burner.



The electrode of the spark igniter is exposed beyond the top of the burner. When cleaning the burner bowl, be careful not to snag the electrode of the spark igniter with your cleaning cloth. Damage to the igniter could occur. Be careful not to turn on any cooktop controls while cleaning burner bowls. A slight electrical shock might result, which could cause you to knock over hot cookware.

### To replace:

1. Place the trim ring on the burner body.
2. Position the burner top on the burner body. To correctly seat the burner top, examine the four notches on the underside of the burner top. One of them is shaped

differently than the other three. It includes an indexing key for the spark igniter. The notch with the indexing key fits over the spark igniter when positioning burner top.

3. Place burner grate over burner assembly and into burner bowl. The bottoms of the four larger burner grate fingers fit into four corresponding indentations in the burner bowl.

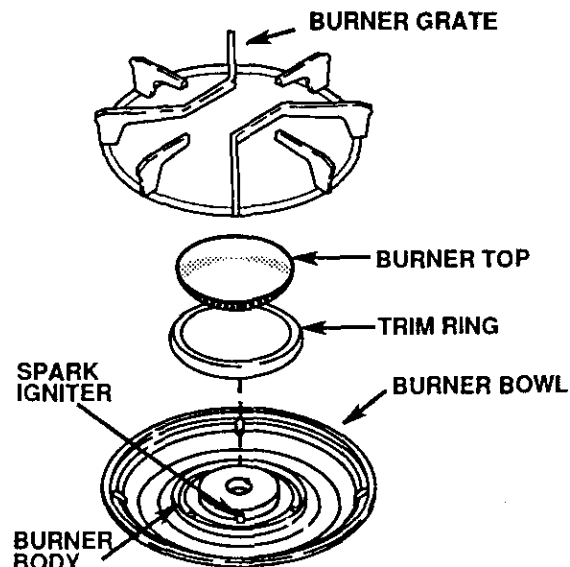

## REMOVABLE OVEN BOTTOM

The oven bottom may be removed for cleaning heavy spillovers or to reach the oven burner.

**Be careful not to scratch the oven finish when removing or replacing the oven bottom.**

### To remove:

1. Slide the tab at the center front of the oven bottom to the left.
2. Lift the oven bottom up and out.

### To replace:

1. Slip the oven bottom into the oven so the tabs in the rear of the oven bottom fit into the slots in the oven back.

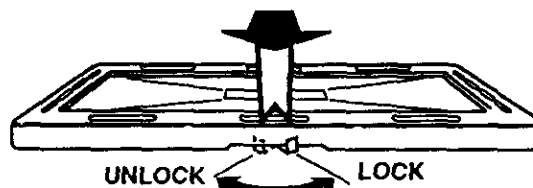

2. Lower the front of the oven bottom into place and slide the tab at the front right to lock the oven bottom into place.

## OVEN SHUT-OFF VALVE AND ELECTRICAL DISCONNECT

The pressure regulator (on range back) contains a lever which turns on or shuts off the gas supply to the oven. The lever is accessible from the front of the range by removing the storage drawer and reaching through the storage compartment and the range back. See the Installation Instructions for more information.

The electrical disconnect is located behind the storage drawer in the lower compartment. Remove storage drawer to access. Squeeze tabs and pull to disconnect.

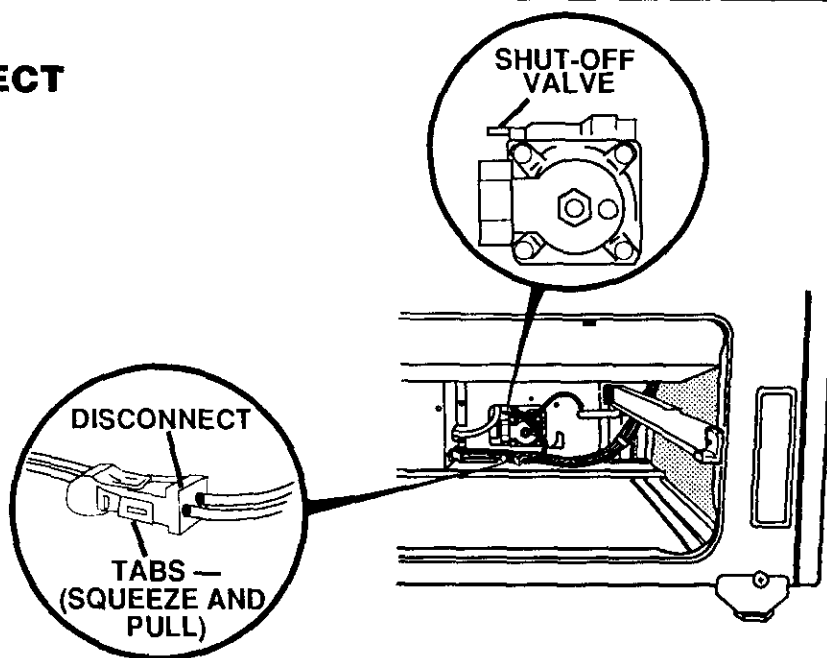

## REPLACING THE OVEN LIGHT

Be sure that the light switch is in the OFF position.



**Do not touch hot oven bulb with wet hands. Do not wipe oven light area with wet cloth. Unplug or disconnect the electrical supply to range before removing.**

Never touch the electrically live collar on the bulb when replacing it.

**Electrical power must be shut off if you have to replace a broken bulb.**

1. Remove the three screws and lift off the glass retainer, glass cover and gasket.
2. Replace the bulb with a 40 watt appliance bulb. An appliance bulb is smaller than a standard 40 watt household bulb.

3. Replace the gasket, glass cover and glass retainer. Tighten screws securely.

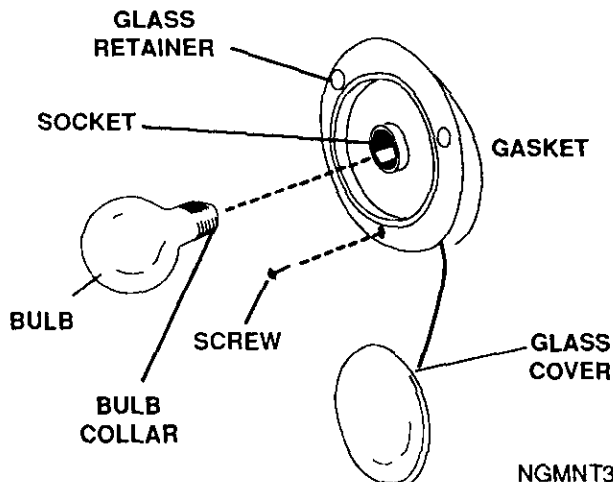

## REMOVABLE OVEN DOOR

### To remove:

1. Open the door to the stop position (see illustration).
2. Grasp the door at each side and lift up and off the hinges.

**NOTE: DO NOT lift the oven door by the handle. Glass breakage or damage to the door could result.**



**NOTE: When the door is removed and hinge arms are at stop position, do not bump or try to move the hinge arms. The hinges could snap back causing an injury to the hands or damage to the porcelain on the front of the range. Cover the hinges with toweling or empty towel rolls while working in the oven area.**

### To replace:

1. Hold the door over the hinges with the slots at the bottom edge of the door lined up with the hinges. **The hinge arms must still be in the stop position.**

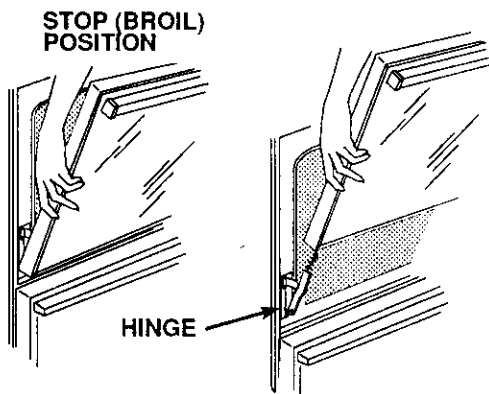

2. Slide the door down onto the hinges as far as it will go and close the door.

## REMOVABLE STORAGE DRAWER

**This drawer gives you space for keeping cookware and bakeware. Plastics and flammable material should not be kept in this drawer.**

Do not overload the storage drawer. If the drawer is too heavy, it may slip off the track when opened. To open the drawer, grasp the center of the handle and pull straight out.

**To remove:** pull drawer straight out and lift over the guide stops.

**To replace:** lift over the guide stops and slide drawer into place.

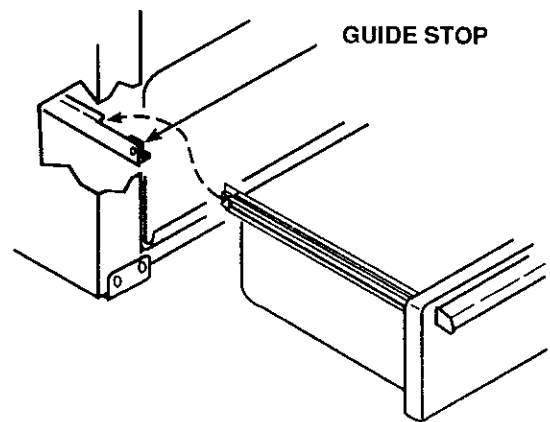

## REMOVABLE OVEN RACKS

**Be careful not to scratch the oven finish when installing or removing oven racks.**

### To install:

1. Set the raised back edge of the rack on a pair of rack guides.
2. Push the rack in until you reach the bump in the rack guide, then lift the front of the rack a bit and push the rack all the way in.

### To remove:

1. Pull the oven rack out, then up.

The shelves are designed with stop locks so when placed correctly on the shelf support, and extended from the oven, the stop lock prevents the racks from tilting when you are removing food from the racks or placing food on them.

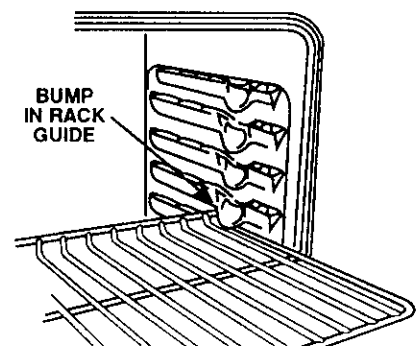



**Note: If oven racks are left in the range during a clean cycle, they will darken, lose their luster and become hard to slide. If you choose to leave the racks in the oven, you can polish the edges of the racks with steel wool and apply a small amount of vegetable oil to the rack edges after the self-clean cycle. This will make the racks easier to slide.**

## BEFORE CALLING FOR SERVICE

Save time and money — Check this list before you call for service.

To eliminate unnecessary service calls, first, read all the instructions in this manual carefully. Then, if you have a problem, always check this list of common problems and possible solutions before you call for service.

If you do have a problem you cannot fix yourself, call your nearest Sears Store or Service Center for help. When calling, have this manual, the Repair Parts List, model number and purchase date handy.

PROBLEM	POSSIBLE CAUSE	DON'T CALL FOR SERVICE UNTIL YOU CHECK
<ul style="list-style-type: none"> <li>• <b>"F" AND ANY NUMBER FLASH IN DISPLAY AND CONTROL BEEPS</b></li> </ul>	<ul style="list-style-type: none"> <li>• Possible oven malfunction</li> </ul>	<ul style="list-style-type: none"> <li>• Press CLEAR/OFF. Allow oven to cool 1 hour. Place back into operation. If problem repeats, disconnect power and gas supply. Call for service.</li> </ul>
<ul style="list-style-type: none"> <li>• <b>RANGE DOES NOT WORK; TOTALLY INOPERATIVE</b></li> </ul>	<ul style="list-style-type: none"> <li>• No power to range</li> </ul>	<ul style="list-style-type: none"> <li>• Check power cord to be sure it is plugged in.</li> </ul>
<ul style="list-style-type: none"> <li>• <b>COOKTOP BURNERS AND OVEN BURNERS DO NOT WORK</b></li> </ul> <div data-bbox="133 923 541 1051" style="border: 1px solid black; padding: 5px; margin-top: 10px;">  <p>Oven burners cannot be lit during a power failure.</p> </div>	<ul style="list-style-type: none"> <li>• Range not properly grounded or polarized; This can affect spark ignition</li> <li>• Controls not set correctly</li> <li>• Gas not turned on</li> </ul> <div data-bbox="568 923 987 1123" style="border: 1px solid black; padding: 5px; margin-top: 10px;">  <p><b>Warning: Lighting gas burners with a match is dangerous. You should match light the cooktop burners only in emergency.</b></p> </div>	<ul style="list-style-type: none"> <li>• Check Installation Instructions packed with your range.</li> <li>• Check operating Instructions in this manual.</li> <li>• To check if the gas is turned on, light the cooktop burners with a match by following the steps in the Ignition section of this manual. If the burners do not light, check the shut-off valve in the lower compartment (see Installation Instructions) and the main gas shut-off valve to be sure they are in the open position.</li> </ul>
<ul style="list-style-type: none"> <li>• <b>COOKTOP BURNER DOES NOT WORK; OVEN OK</b></li> </ul>	<ul style="list-style-type: none"> <li>• Soil clogging holes (ports) in burner or burner not assembled properly</li> <li>• Improper operation of control</li> </ul>	<ul style="list-style-type: none"> <li>• See the removable cooktop burner section and the cleaning tips in this manual.</li> <li>• Be sure to push knob in while turning.</li> </ul>
<ul style="list-style-type: none"> <li>• <b>FOODS DO NOT BAKE PROPERLY</b></li> </ul>	<ul style="list-style-type: none"> <li>• Oven not preheated long enough</li> <li>• Improper rack or pan placement</li> <li>• Oven vent blocked or covered</li> <li>• Improper temperature setting for utensil used</li> <li>• Recipe not followed</li> <li>• Improper thermostat calibration</li> <li>• Range and oven rack not level</li> <li>• Using improper cookware</li> </ul>	<ul style="list-style-type: none"> <li>• Be sure to preheat until preheat notification tone sounds.</li> <li>• Maintain uniform air space around pans and utensils; see oven cooking section.</li> <li>• Be sure oven vent (in panel behind cooktop) is not blocked.</li> <li>• Reduce temperature 25 degrees for glass or dull/darkened pans.</li> <li>• Is recipe tested and reliable?</li> <li>• Check oven temperature adjustment procedures following this section.</li> <li>• Check installation instructions for leveling instructions.</li> <li>• See oven cooking section.</li> </ul>

## BEFORE CALLING FOR SERVICE (continued)

<b>PROBLEM</b>	<b>POSSIBLE CAUSE</b>	<b>DON'T CALL FOR SERVICE UNTIL YOU CHECK</b>
<ul style="list-style-type: none"> <li>• <b>FOODS DO NOT BROIL PROPERLY</b></li> </ul>	<ul style="list-style-type: none"> <li>• Oven door not closed</li> <li>• Improper rack position</li> <li>• Oven preheated</li> <li>• Improper utensil used</li> <li>• Improper broiling time</li> </ul>	<ul style="list-style-type: none"> <li>• Close oven door.</li> <li>• Check broil pan placement; see Broiling section.</li> <li>• Do not preheat when broiling.</li> <li>• Use broiler pan and grid supplied with range.</li> <li>• Check broiling chart.</li> </ul>
<ul style="list-style-type: none"> <li>• <b>OVEN SMOKES</b></li> </ul>	<ul style="list-style-type: none"> <li>• Dirty oven</li> <li>• Broiler pan full of grease left in oven</li> </ul>	<ul style="list-style-type: none"> <li>• Check for heavy spillover.</li> <li>• Clean pan and grid after each use.</li> </ul>
<ul style="list-style-type: none"> <li>• <b>OVEN LIGHT DOES NOT WORK</b></li> </ul>	<ul style="list-style-type: none"> <li>• Light switch in off position</li> <li>• Light bulb burned out</li> </ul>	<ul style="list-style-type: none"> <li>• Check switch setting.</li> <li>• Check or replace light bulb.</li> <li>• See use and care instructions.</li> </ul>
<ul style="list-style-type: none"> <li>• <b>TICKING SOUND OF SPARK IGNITER PERSISTS AFTER BURNER LIGHTS</b></li> </ul>	<ul style="list-style-type: none"> <li>• Spark igniter not de-activated</li> </ul>	<ul style="list-style-type: none"> <li>• Turn burner off and relight. Some ticking is normal. If ticking is excessive, call for service.</li> </ul>
<ul style="list-style-type: none"> <li>• <b>OVEN ODOR</b></li> </ul>	<ul style="list-style-type: none"> <li>• Oven insulation may emit odor during first few usages</li> </ul>	<ul style="list-style-type: none"> <li>• Odor from new insulation will burn off after several usages.</li> </ul>

## “DO-IT-YOURSELF” OVEN TEMPERATURE ADJUSTMENT

You may feel that your new oven cooks differently than the oven it replaced. We recommend that you use your new oven a few weeks to become more familiar with it, following the times given in your recipes as a guide.

Your oven has been preset to maximize cooking efficiency. If you think your new oven is too hot (burning foods), or not hot enough (foods are under-cooked) you can adjust the temperature yourself. The appearance and texture of foods is a better indicator of oven accuracy than an inexpensive oven thermometer. **We do not recommend the use of inexpensive thermometers, such as those found in the grocery store, to readjust the temperature setting of your new oven.** These thermometers can vary by 20°-40°F. Also, you must open the oven door to read the thermometer and this changes the temperature of the oven.

To decide how much to change the temperature, set the oven temperature 25°F higher (if foods are under-cooked) or 25°F lower (if foods are burning) than the temperature in your recipe, then bake. The results of this “test” should give you an idea of how much the temperature should be changed.

**To adjust temperature follow these instructions:**



1. Press the **BAKE** pad.
2. Press the **UP** arrow pad to set 550° and **IMMEDIATELY** press and **HOLD** the **BAKE** pad for 10 seconds until the clock disappears and the display shows a two digit figure.



(This two digit number may vary according to the original factory setting.)



3. Press the **UP** arrow to increase your oven's temperature up to +35° **HOTTER**.

Press the **DOWN** arrow pad to decrease your oven's temperature down to -35° **COOLER**.



4. When your selection is complete press the **CLOCK** pad to return to the time of day.

Your oven's thermostat will retain this temperature adjustment until each of the four steps above are repeated. This adjustment will remain in memory even after a power failure.

You will not need to do anything else. Bake as you normally would. This adjustment will not affect broil or clean temperature.



# KENMORE GAS RANGE WARRANTY

Dear Customer:

Our constant efforts are directed toward making sure your new Kenmore Range will arrive at your home in perfect condition and will give you proper performance. As part of these efforts, we feel it is our responsibility to provide you with this warranty for your range.



## FULL ONE YEAR WARRANTY ON THE FUNCTIONING OF ALL PARTS EXCEPT GLASS PARTS

If, within one year from the date of installation, any part, other than a glass part, fails to function properly due to a defect in material or workmanship, Sears will repair or replace it, free of charge.

## FULL 30-DAY WARRANTY ON GLASS PARTS AND FINISH OF PORCELAIN ENAMEL, PAINTED OR BRIGHT METAL FINISHED PARTS

If, within 30 days from the date of installation, any glass part or the finish on any porcelain enamel, painted or bright metal part is defective in material or workmanship, Sears will replace the part, free of charge.

## FULL 90-DAY WARRANTY ON MECHANICAL ADJUSTMENTS

For 90 days from the date of installation, Sears will provide, free of charge, any mechanical adjustments necessary for proper operation of the range, except for normal maintenance.

If the range is subjected to other than private family use, the above warranty coverage is effective for only 90 days.

## WARRANTY SERVICE IS AVAILABLE BY CONTACTING THE NEAREST SEARS SERVICE CENTER/DEPARTMENT IN THE UNITED STATES

This warranty applies only while this product is in use in the United States. This warranty gives you specific legal rights, and you may also have other rights which vary from state to state.

**SEARS, ROEBUCK and CO.**  
Dept. 731 CR-W  
Sears Tower  
Chicago, IL 60684

## WE SERVICE WHAT WE SELL

"We Service What We Sell" is our assurance to you that you can depend on Sears for service because Sears service is nationwide.

Your Kenmore Range has added value when you consider that Sears has a service unit near you staffed by Sears trained technicians. . . professional technicians specifically trained on Sears appliances, having the parts, tools and equipment to ensure that we meet our pledge to you — "We Service What We Sell!"

**TO FURTHER ADD TO THE VALUE OF YOUR RANGE, BUY A SEARS MAINTENANCE AGREEMENT.**

Kenmore Ranges are designed, manufactured and tested for years of dependable operation. Yet, any modern appliance may require service from time to time. The Sears Warranty plus the Sears Maintenance Agreement provides protection from unexpected repair bills and assures you of enjoying maximum range efficiency.

Here's a comparative warranty and Maintenance Agreement chart showing you the benefits of a Sears Range Maintenance Agreement.

Years of Ownership Coverage	1st Year	2nd Year	3rd Year
1 Replacement of Defective Parts other than Porcelain or Glass	W	MA	MA
2 Mechanical Adjustment	90 DAYS W	MA	MA
3 Porcelain and Glass Parts	30 DAYS W	MA	MA
4 Annual Preventive Maintenance Check at your request	MA	MA	MA

W - Warranty MA - Maintenance Agreement

**CONTACT YOUR SEARS SALESPERSON OR LOCAL SEARS SERVICE CENTER TODAY AND PURCHASE A SEARS MAINTENANCE AGREEMENT.**

**Kenmore® America's Best Selling Appliance Brand**

Sold by SEARS, ROEBUCK AND CO., Chicago, IL 60684

— Printed in LaFayette, Georgia —