

A  
LEADING  
BRAND IN THE UK

# Russell Hobbs®

CLASSIC SATIN



## Glass Toaster

OWNER'S MANUAL  
RHG2T

# IMPORTANT SAFEGUARDS

When using electrical appliances, basic safety precautions should always be followed including the following:

1. Read all instructions.
2. Do not touch hot surfaces. Use handles or knobs.
3. To protect against electrical shock do not immerse cord, plugs, or appliance in water or other liquid.
4. Close supervision is necessary when any appliance is used by or near children.
5. Unplug from outlet when not in use and before cleaning. Allow to cool before putting on or taking off parts.
6. Do not operate any appliance with a damaged cord or plug or after the appliance malfunctions, or has been damaged in any manner. Contact Consumer Service for examination, repair or adjustment.
7. The use of accessory attachments not recommended by the appliance manufacturer may cause injuries.
8. Do not use outdoors.
9. Do not let cord hang over edge of table or counter, or touch hot surfaces.
10. Do not place on or near a hot gas or electric burner, or in a heated oven.
11. To disconnect, press the  CANCEL Button, then remove plug from wall outlet.
12. Do not use appliance for other than intended use.
13. Oversize foods, metal foil packages, or utensils must not be inserted in a Toaster as they may involve a risk of fire or electric shock.
14. A fire may occur if toasters are covered or touching flammable material, including curtains, draperies, walls, and the like, when in operation.
15. Do not attempt to dislodge food when toaster is plugged in.

**SAVE THESE INSTRUCTIONS  
FOR HOUSEHOLD USE ONLY**

# ADDITIONAL IMPORTANT SAFEGUARDS

**CAUTION HOT SURFACES:** This appliance generates heat and escaping steam during use. Proper precautions must be taken to prevent the risk of burns, fires, or other injury to persons or damage to property.

1. A person who has not read and understood all operating and safety instructions is not qualified to operate this appliance. All users of this appliance must read and understand this Owner's Manual before operating or cleaning this appliance.
2. If this appliance falls or accidentally becomes immersed in water, unplug it from the wall outlet immediately. **Do not reach into the water!**
3. When using this appliance, provide adequate air space above and on all sides for air circulation. Do not operate this appliance while it is touching or near curtains, wall coverings, clothing, dishtowels or other flammable materials.
4. To reduce the risk of fire, do not leave this appliance unattended during use.
5. If this appliance begins to malfunction during use, immediately press the  CANCEL Button and unplug the cord. Do not use or attempt to repair a malfunctioning appliance!
6. The cord to this appliance should only be plugged into a 120V AC electrical wall outlet.
7. Do not use this appliance in an unstable position.
8. Use the Toaster on a hard, flat surface. Do not place it near a flame or heat or on a soft surface (such as carpet). Avoid placing it where it may tip over during use. Dropping the Toaster could cause it to malfunction.

**WARNING: ELECTRICAL SHOCK HAZARD.** Never attempt to dislodge food inside the Toaster while the Toaster is plugged in. Doing so could cause an electrical shock hazard or a risk of fire.

**CAUTION:** This appliance is hot during operation and retains heat for some time after turning off. Always use oven mitts when handling hot materials and allow metal parts to cool before cleaning. Do not place anything on top of the Toaster while it is operating or while it is hot.

**CAUTION:**

**DO NOT** toast pastries with runny fillings or frosting.

**DO NOT** toast torn slices of bread.

**DO NOT** place buttered bread or wrapped food into the Toaster.

**DO NOT** toast small-size breads, mini-baguettes, breadsticks, etc.

**POLARIZED PLUG**

This appliance has a polarized plug (one blade is wider than the other). To reduce the risk of electric shock, this plug is intended to fit into a polarized outlet only one way. If the plug does not fit fully in the outlet, reverse the plug. If it still does not fit, contact a qualified electrician. Do not attempt to modify the plug in any way.

**SHORT CORD INSTRUCTIONS**

A short power-supply cord (or detachable power-supply cord) is provided to reduce the risk resulting from becoming entangled in or tripping over a longer cord.

Do not use an extension cord with this product.

**PLASTICIZER WARNING**

**CAUTION:** To prevent Plasticizers from migrating from the finish of the counter top or table top or other furniture, place **NON-PLASTIC** coasters or place mats between the appliance and the finish of the counter top or table top.

**Failure to do so may cause the finish to darken, permanent blemishes may occur or stains can appear.**

**ELECTRIC POWER**

If the electrical circuit is overloaded with other appliances, your appliance may not operate properly. It should be operated on a separate electrical circuit from other appliances.

# INTRODUCTION

Congratulations on your purchase of the Russell Hobbs® Glass Toaster. Russell Hobbs has combined stainless steel and glass with elegant and angular lines to create this beautiful kitchen appliance. These practical features are perfect to add style to any kitchen.

PRODUCT MAY VARY SLIGHTLY FROM ILLUSTRATIONS

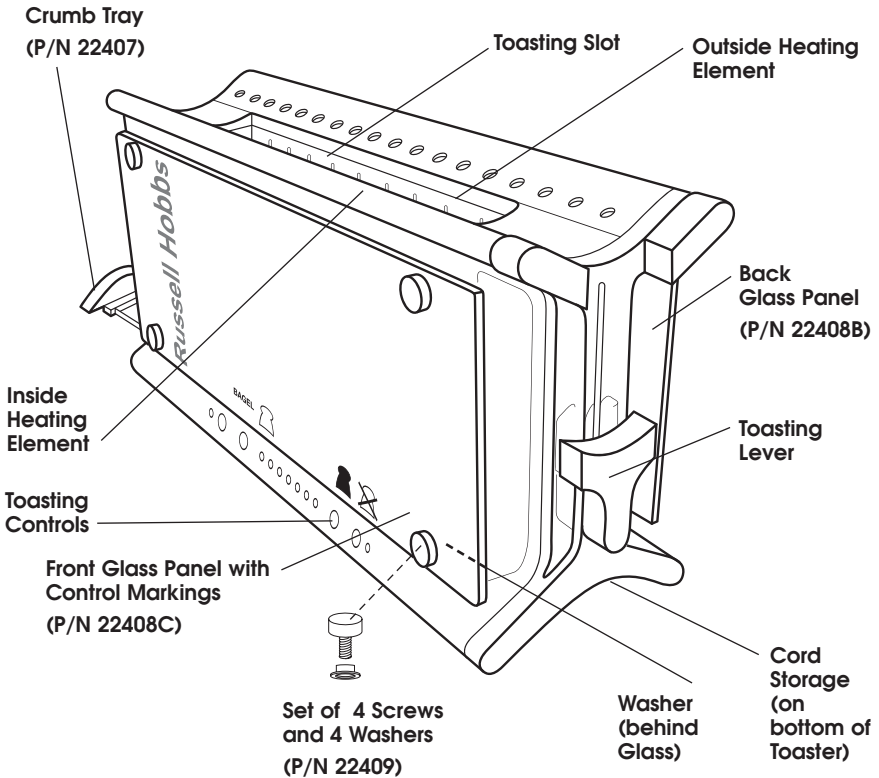

# BEFORE USING FOR THE FIRST TIME



1. Carefully unpack your Russell Hobbs Glass Toaster.
2. To remove any dust that may have accumulated during packaging, simply wipe the Toaster's Glass exterior with a clean, damp cloth.
3. Do not use abrasive cleansers.
4. Never place the Toaster, cord or plug in water or any other liquid.

# Operating Instructions

## SELECTING TOAST COLOR





The Toasting Controls are located at the front of the Toaster. When the Toaster is plugged in, the Browning Level Lights will illuminate.

Press the  LIGHTER or the  DARKER Browning Controls to lighten or darken the toast. Additional Browning Level Lights will illuminate as the toasting color is darkened: 1 illuminated Light for warm and very light toasting, up to 7 illuminated Lights for dark toasting. For your first toasting, the Browning Level should be set at medium toasting (4 illuminated Lights), then adjust each subsequent toasting to your preference.

**CAUTION: This appliance is hot during use. Always use oven mitts when handling hot materials. Do not place anything on top of the Toaster while it is operating or while it is hot.**

## TOASTING BREAD

1. Place your Toaster on a flat, level surface.
2. Plug the Toaster into a 120V AC electrical outlet. The Browning Level Lights will illuminate.
3. Adjust the toast color desired by pressing the  LIGHTER or the  DARKER Browning Controls. The Browning Level Lights will indicate color selected.
4. Remove all protective wrappings from food before placing into the Toasting Slot. Avoid toasting torn bread slices or broken pastries that may get lodged in Toasting Slot.
5. Insert the bread, bagel, or toaster food into the Toasting Slot. Press the Toasting Lever downward until it locks into place. The Centering Guides will automatically center the food for even toasting. When the food is lowered into position, it will automatically begin to toast. The Toasting Indicator Light will illuminate.

**NOTE:** The Toasting Lever will not lock into position unless the Toaster is plugged in!

**NOTE:** When toasting a single slice, the bread or toaster food may be placed anywhere in the Toasting Slot.



**NOTE:** To prevent a fire hazard, never place bread over the opening of the Toaster, but always place it into the Slot.

**NOTE:** DO NOT change the Adjustable Browning Control selection during the toasting cycle. First press  CANCEL, then press the Browning Controls to adjust the browning level. Replace bread and toast until the desired toast color is achieved.

6. When the toast reaches the selected browning level, it will pop up. The Toasting Indicator Light will turn off.
7. Remove bread from Toasting Slot. Use care when removing bread as the bread and Toaster will still be hot.
8. Unplug cord from wall outlet when not in use.

## USING THE BAGEL MODE

The BAGEL Mode is especially helpful when toasting bagels, or if you would prefer to toast your bread or toaster food with **one side darker**.

1. Always slice bagels into equal halves before toasting.
2. Place your Toaster on a flat, level surface.
3. Plug the Toaster into a 120V AC electrical outlet. The Browning Level Lights will illuminate.
4. Adjust the toast color desired by pressing the  LIGHTER or the  DARKER Browning Controls. The Browning Level Lights will indicate color selected.
5. Place the cut side of the bagel facing the front of the Toaster, with the Toasting Controls labelled on the Glass. When in the BAGEL Mode, the inside Heating Element will toast darker than the outside Heating Element.
6. As soon as the Toasting Lever is lowered and locked into position, press the BAGEL Button. The Bagel Indicator Light will illuminate, indicating the Toaster is ON and in the BAGEL Mode.

**IMPORTANT:** The BAGEL Mode will not work properly if you press the BAGEL Button first, then lower the Toasting Lever.

7. When the bagel or toaster food reaches the selected color, it will pop up. The Bagel Indicator Light will turn off.



## CANCEL BUTTON



At any time during the toasting process, you may press the CANCEL Button to end the toasting function and force the bread to pop up.

## CONVENIENCE FOODS TOASTING

Today there are many varieties of packaged convenience foods available, both frozen and non-frozen (shelf pastry) that can be toasted in your Toaster.

Since toaster foods and individual tastes vary, it is difficult to recommend exact Toast Color Control Settings. However, after a little experimentation, you will discover the best setting for your needs. You may also wish to refer to the heating instructions on the food packaging.

## PASTRY

For best results, follow the instructions printed on the pastry package. If the package does not have instructions, press the  LIGHTER or the  DARKER Browning Controls until 4 Browning Level Lights are illuminated, indicating a MEDIUM color has been selected. Some pastries may require a second toasting cycle.

**NOTE: Do not use this Toaster for toasting pastry items with runny-type frosting or open fillings.**

## REMOVING LODGED TOAST

If a piece of toast becomes lodged in the Toaster, unplug the Toaster and allow to cool. Press the Toasting Lever down. Turn the Toaster upside down, and shake the toast loose.

**IMPORTANT: Never use a fork or sharp-edged utensil to remove toast, because that may damage the heating element or cause injury.**

## IMPORTANT POINTS

- Remove all protective wrappings from food before placing in the Toasting Slot.
- For best results, clean Crumb Tray frequently.
- Different breads require different color settings. Raise Toasting Lever manually or press the  CANCEL Button at any time to check toast color.
- Do not block top opening. Do not place any object over the top opening.
- Do not toast buttered bread or buttered pita bread. Melted butter will cause fire.
- Bread which has been toasted but not buttered may be reheated. Use a lighter setting and watch it carefully.
- When toasting more than one slice of bread, use slices of similar size, thickness and freshness.
- Stale bread, thin bread or sweet bread products, such as tea cakes and fruit loaf, brown much more quickly than ordinary bread, so they should be toasted on the lighter settings.
- Never immerse Toaster, cord or plug in water or other liquid.
- **Never use a fork or sharp-edged utensil to remove toast, because that may damage the heating element or cause injury.**

## User Maintenance Instructions

This appliance requires little maintenance. It contains no user serviceable parts. Do not try to repair it yourself. Any servicing that requires disassembly other than cleaning must be performed by a qualified appliance repair technician.

### REMOVING AND CLEANING THE GLASS PANEL

1. Always unplug the Toaster and allow it to completely cool before cleaning or removing the Glass Panels.
2. Use your fingers to unscrew the Screws at the corners of each of the Glass Panels.

**WARNING: DO NOT USE PLIERS OR ANY OTHER TOOL TO REMOVE SCREWS. USING ANY TYPE OF TOOL MAY DAMAGE THE FINISH ON THE SCREWS AND BREAK THE GLASS.**

## **User Maintenance Instructions** *(Continued)*

3. Lift the Glass Panels off. Remove the Washers from the back of the Glass— don't lose them!
4. Wash the Glass Panels in warm soapy water and dry thoroughly.
5. Replace the Glass Panels, one at a time.

**IMPORTANT: Avoid touching the insides of the Glass Panels to prevent smudges or fingerprints on the Glass.**

6. Fit the small end of the Washers into the holes behind the Glass. Hold the Glass firmly so that the holes align with the holes in the Toaster.
7. Replace the Screws and finger-tighten only — don't use tools.

**WARNING: DO NOT USE PLIERS OR ANY OTHER TOOL TO REPLACE SCREWS. USING ANY TYPE OF TOOL MAY DAMAGE THE FINISH ON THE SCREWS AND BREAK THE GLASS.**

## **CLEANING INSTRUCTIONS**

**CAUTION: Do not immerse Toaster, cord, or plug in water or any other liquid.**

**CAUTION: Be sure the Toaster is unplugged before cleaning.**

Wipe the Toaster exterior with a clean, damp cloth. Do not use abrasive cleaners. Do not put cord, or plug in water or liquid.

**CRUMB TRAY:** Remove the Crumb Tray at bottom of the Toaster by pulling the Crumb Tray away from the bottom of the Toaster, allowing the crumbs to fall out.

We suggest that you do this over a sink or over a garbage can.

Wipe the Crumb Tray with a clean, damp cloth. Replace the Crumb Tray, making sure to push firmly so that it is fully inserted in the bottom of the Toaster.

**EXTERIOR:** Wipe surfaces with a clean, damp cloth. Do not use abrasive cleansers, as they may scratch the surfaces.

## **STORAGE INSTRUCTIONS**

Unplug unit, allow to cool, and clean before storing. Store Toaster in its box in a clean, dry place. Never store Toaster while it is hot or still plugged in. Never wrap cord tightly around the appliance, use the Cord Storage area on the bottom of the Toaster. Do not put any stress on the cord where it enters the unit, as it could cause the cord to fray and break.

## LIMITED ONE YEAR WARRANTY

**Warranty:** This Russell Hobbs® product is warranted by Salton, Inc. to be free from defects in materials or workmanship for a period of (1) year from the original purchase date. This product warranty covers only the original consumer purchaser of the product.

**Warranty Coverage:** This warranty is void if the product has been damaged by accident in shipment, unreasonable use, misuse, neglect, improper service, commercial use, repairs by unauthorized personnel, normal wear and tear, improper assembly, installation or maintenance abuse or other causes not arising out of defects in materials or workmanship. This warranty is effective only if the product is purchased and operated in the USA, and does not extend to any units which have been used in violation of written instructions furnished with the product or to units which have been altered or modified or to damage to products or parts thereof which have had the serial number removed, altered, defaced or rendered illegible.

**Implied Warranties:** ANY IMPLIED WARRANTIES WHICH THE PURCHASER MAY HAVE ARE LIMITED IN DURATION TO ONE (1) YEAR FROM THE DATE OF PURCHASE. Some states do not allow limitations on how long an implied warranty lasts, so the above limitation may not apply to you.

**Warranty Performance:** During the above one-year warranty period, a product with a defect will be either repaired or replaced with a reconditioned comparable model (at our option) when the product is returned to the Repair Center, or the purchase price refunded. The repaired or replacement product will be in warranty for the balance of the one-year warranty period and an additional one-month period. No charge will be made for such repair or replacement.

**Service and Repair:** Should the appliance malfunction, you should first call toll-free 1 (800) 233-9054 between the hours of 9:00 am and 5:00 pm Central Standard Time and ask for CONSUMER SERVICE stating that you are a consumer with a problem. Please refer to model number RHG2T when you call.

**In-Warranty Service (USA):** For an appliance covered under the warranty period, no charge is made for service or postage. Call for return authorization (800) 233-9054.

**Out-of-Warranty Service:** A flat rate charge by model is made for out-of-warranty service. Include \$15.00 (U.S.) for return shipping and handling. We will notify you by mail of the amount of the charge for service and require you to pay in advance for the repair or replacement.

**For Products Purchased in the USA, but Used in Canada:** You may return the product insured, packaged with sufficient protection, and postage and insurance prepaid to the USA address listed below. Please note that all customs duty / brokerage fees, if any, must be paid by you and we will require you to pay the cost of customs duty / brokerage fees to us in advance of our performing any service.

**Risk During Shipment:** We cannot assume responsibility for loss or damage during incoming shipment. For your protection, carefully package the product for shipment and insure it with the carrier. Be sure to enclose the following items with your appliance: any accessories related to your problem, your full return address and daytime phone number, a note describing the problem you experienced, a copy of your sales receipt or other proof of purchase to determine warranty status. C.O.D. shipments cannot be accepted.

**To return the appliance, ship to:**

ATTN: Repair Center  
Salton, Inc.  
708 South Missouri Street  
Macon, MO 63552

**To contact us, please write to, call, or email:**

Salton, Inc.  
P.O. Box 7366  
Columbia, MO 65205-7366  
1-800-233-9054  
E-mail: Salton@Saltonusa.com

**Limitation of Remedies:** No representative or person is authorized to assume for Salton, Inc. any other liability in connection with the sale of our products. There shall be no claims for defects or failure of performance or product failure under any theory of tort, contract or commercial law including, but not limited to negligence, gross negligence, strict liability, breach of warranty and breach of contract. Repair, replacement or refund shall be the sole remedy of the purchaser under this warranty, and **in no event shall Salton be liable for any incidental or consequential damages, losses or expenses.** Some states do not allow the exclusion or limitation of incidental or consequential damages, so the above limitation or exclusion may not apply to you.

**Legal Rights:** This warranty gives you specific legal rights, and you may also have other rights which vary from state to state.

For more information on Salton products: visit our website: [www.eSalton.com](http://www.eSalton.com)

©2003 Salton, Inc. All rights reserved.

Made in China

P/N 61418

10/03