

# Rowenta



mod. DZ5020

GB

D

F

I

SP

P

RF

GR

UA

[www.rowenta.com](http://www.rowenta.com)

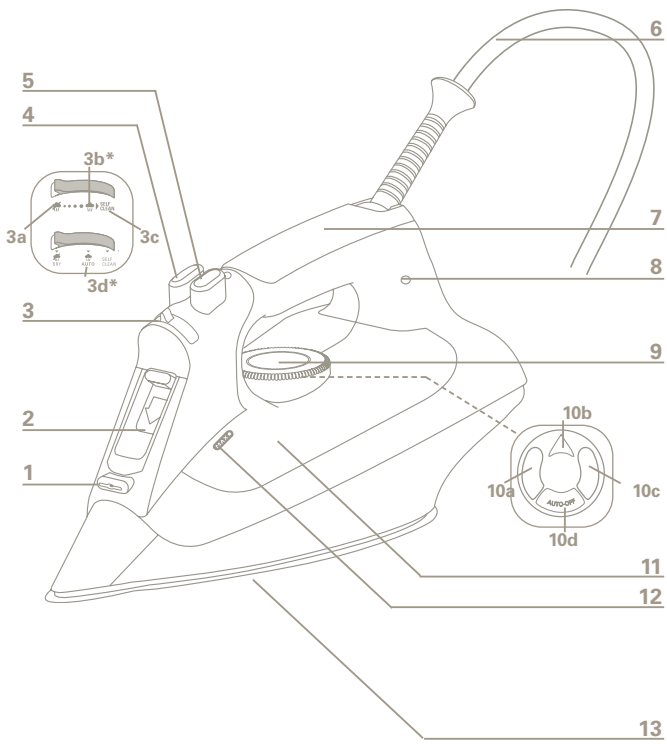

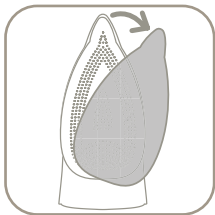

fig. 1

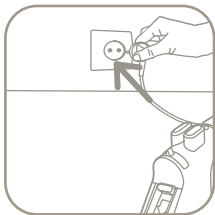

fig. 2



fig. 3



fig. 4

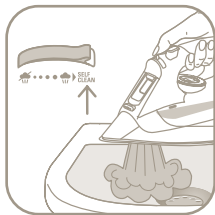

fig. 5



fig. 6



fig. 7



fig. 8



fig. 9

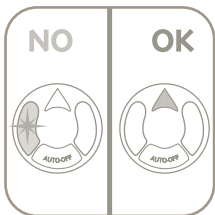

fig. 10

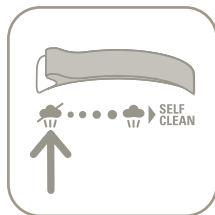

fig. 11



fig. 12

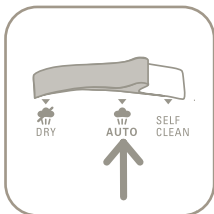

fig. 13

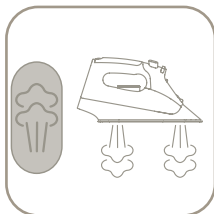

fig. 14

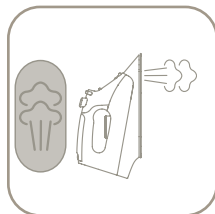

fig. 15



fig. 16



fig. 17

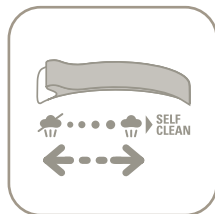

fig. 18

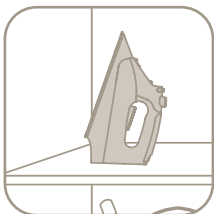

fig. 19



fig. 20

З праски витікає вода.	Занадто часте натискання кнопки парового удару.	Робіть більші інтервали між натисканнями кнопки.
	Використовується дистильована/демінералізована або пом'якшена вода.	Використовуйте тільки необроблену воду з-під крана або наполовину розведіть воду з-під крана дистильованою/демінералізованою водою. Виконайте процедуру Self Clean (самоочищення), а потім почистіть праску.
Підшва брудна або забарвлена в коричневий колір і може бруднити білизну.	Використання крохмалю.	Розпилюйте крохмаль тільки на зворотний бік тканини, що прасується, а після використання крохмалю очищайте праску.
	Температура підшви занадто низька.	Виставте більш високу температуру.

Якщо вам не вдається визначити причину виникнення проблеми, зв'яжіться з уповноваженим сервіс-центром фірми "Ровента".





Адреси наведені в доданому переліку сервіс-центрів.

Номери телефонів для консультацій наведені на першій сторінці цієї інструкції.

Інші поради і примітки ви зможете знайти на нашій веб-сторінці: [www.rowenta.com](http://www.rowenta.com).

Можуть бути внесені зміни!

## DESCRIPTION

- |   |   |    |                                  |
|---|---|----|----------------------------------|
| 1 | Spray nozzle  | 7  | Handle                           |
| 2 | Filling inlet<br>(with slide-button opening)  | 8  | Thermostat control light*        |
| 3 | Variable steam control  | 9  | Temperature control dial         |
|   | a Dry ironing          | 10 | LED display*                     |
|   | b Steam max. position  | a  | Yellow LED                       |
|   | c Self Clean  | b  | Green LED                        |
|   | d Autosteam  *         | c  | Red LED                          |
| 4 | Spray button           | d  | Auto-off LED                     |
| 5 | Shot of steam button   | 11 | Water tank                       |
| 6 | Cord  | 12 | Maximum water level<br>indicator |
|   |   | 13 | Soleplate                        |

## SAFETY INSTRUCTIONS

This appliance complies with the technical rules and standards for safety currently in force (Electromagnetic Compatibility, Low Voltage, Environment).

The appliance may only be connected to alternating current as specified on the rating plate. Only safe extension leads should be used.

An electrical appliance is not a toy. Use and store the appliance out of reach of children. Do not let the supply cord hang down.

Do not leave the appliance unattended while it is connected to the mains supply.

Electrical appliances generate high temperatures. Always use the handle and warn other users of the potential dangers (e.g. escaping steam or hot water, especially when ironing vertically).

Never direct steam at persons or animals, never treat clothing which is being worn.

Always unplug the appliance before filling or emptying the water tank; before leaving the room (even for a short time); before cleaning the appliance and after use.

Never unplug the appliance by tugging on the cord. Do not immerse the appliance in water.

An electrical appliance should not be used if:

- the appliance is not functioning correctly;
- the appliance, the supply cord or the cord protector is damaged;
- the appliance has been dropped;

– the appliance is obviously leaking. In these cases the appliance should be returned to an approved Rowenta Customer Service Centre for repair. (See enclosed Service Centre addresses.) Repairs to electrical appliances may only be carried out by specialists. Improperly carried out repairs can cause serious danger to users. To avoid danger to users, a defective or damaged supply cord may only be replaced by an authorised Rowenta Customers Service Centre .

This product has been designed for domestic use only. Any commercial use, inappropriate use or failure to comply with the instructions, the manufacturer accepts no responsibility and the guarantee will not apply.

## Environment protection first !

Your appliance contains valuable materials which can be recovered or recycled. Leave it at a local civic waste collection point.



## Keep these instructions

## BEFORE USE

### 1 • Unpacking

Take the iron out of the box and remove all the stickers.

**IMPORTANT** Before doing anything else, remove the soleplate protector (fig.1)!

### 2 • What water may be used ?

Your iron has been designed to operate using untreated tap water up to 17° dH (German water hardness). If in doubt, check with your local water authority. However, if your water is very hard, you can mix 50% untreated tap water with 50% distilled or demineralised water.

**IMPORTANT** Heat concentrates the elements contained in water during evaporation. The types of water listed below contain organic waste or mineral elements that can cause spitting, brown staining or premature wear of the appliance:- water from clothes dryers, scented or softened water, water from refrigerators, batteries or air conditioners, pure distilled

or demineralised water or rain water should not be used in your iron. Also do not use boiled, filtered or bottled water.

### 3 • Using for the first time

Plug in the iron (fig.2) and set the temperature control dial (fig.3) to ●●● to heat the appliance.

A little smoke and a slight smell may be emitted, but this is only temporary.

Unplug the iron (fig.4) and fill the water tank (§ 4 Filling the water tank).

To remove any impurities in the iron's steam chamber, unplug the iron and hold it over a sink horizontally. Push the steam control into the Self Clean position : steam will now begin to build up.

After a few seconds water will emerge from the soleplate, rinsing any impurities out of the steam chamber (fig.5).

Move the steam control to steam  position after approx.

1 minute. Plug in the iron and allow the iron to heat up again.

Wait until the remaining water has evaporated. Unplug from the mains and allow the iron to fully cool down.

## USE

### 4 • Filling the water tank

**IMPORTANT** Before filling the water tank, unplug the iron and set the steam control to dry position .



Tilt the iron. Open the filling inlet (fig.6). Pour in water up to the max mark (fig.7). Close the filler inlet (fig.8) and return the iron to the horizontal.

### 5 • Setting the temperature

Set the iron temperature to suit the type of material using the temperature control dial (fig.3).

Temperature control\*: The temperature control light indicates that the soleplate is heating up. When the temperature control light goes off (fig.9), the set temperature is reached and you can begin ironing.



Ironing label	Fabric	Temperature control
	Synthetic fibres, e.g. viscose, polyester...	•
	Silk, wool	••
	Cotton, linen	•••

Electronic temperature control\*: The traffic lights tell you whether the soleplate is at the selected temperature (fig.10).

YELLOW	The soleplate is still too cold for the selected material.
GREEN	The soleplate is at the right temperature for the selected material.
RED	The soleplate is still too hot for the selected material.
AUTO- OFF	The automatic electronic cut-out* is active.

**IMPORTANT** The iron takes longer to cool down than to heat up. We recommend that you start with fabrics to be ironed at a low temperature. For mixed fabrics set the temperature for the most delicate fabric.

**TIP** Always spray starch onto the reverse side of the fabric to be ironed.

## 6 • Dry ironing



Set the variable steam control to  (fig.11) and set the temperature to suit the type of material (care points •, ••, •••).

## 7 • Steam ironing

You can steam iron from temperature setting •• upwards.

Steam function\* The steam quantity can be set to between no steam (minimum steam quantity) and  (maximum steam quantity) (fig.12). We recommend setting to maximum steam

\* depending on model

quantity  only when the iron is at temperature setting **•••**.  
Auto Steam function\* Set the steam button to  (fig.13) and the steam quantity will adjust automatically to the soleplate temperature.

## 8 • Shot of steam

(from temperature setting **••** upwards)

**IMPORTANT** Leave an interval of 4 seconds between each shot and wait until the flow of steam is finished before standing the iron on its heel.

Press the shot of steam button  to generate a powerful jet of steam and remove stubborn creases (fig.14).

## 9 • Vertical shot of steam

(from temperature setting **••** upwards)

**TIP** Hold the iron 10 to 20 centimetres away from the garment to avoid burning delicate fabrics.

Hold the iron to the vertical and press the shot of steam button ( fig.15) to remove creases from suits, jackets, skirts, hanging curtains etc.

**IMPORTANT** Never direct the steam at persons or animals!

## 10 • Spray

Press the spray button  to dampen stubborn creases (fig.16).

## 11 • Anti-Drip system\*

It prevents water escaping from the soleplate when the temperature is too low.

## 12 • Automatic electronic 3-position cut-out\*

If, although switched on, the appliance is not moved, it will automatically switch off and the auto off light will blink after the following intervals:

- After 30 sec., if the iron is left standing on the soleplate or lying on its side .
- After 8 mins., if the iron is left standing on its heel.

To switch the iron back on, move the iron gently.

## AFTER USE

### 13 • Emptying

Unplug the iron (fig.4), pour away remaining water (fig.17) and set steam control to .

Open and close the steam control several times (fig.18) to prevent the valve hole into the steam chamber from scaling or blocking up.

### 14 • Storing

Allow the appliance to cool down before storing the iron standing on its heel (fig.19).

**IMPORTANT** Do not wind the cord around the hot soleplate. Never store your iron placed down on the soleplate (fig.20).

## MAINTENANCE AND CLEANING

**IMPORTANT** Unplug and allow the iron to fully cool down before maintenance and cleaning.

### 15 • Anti-scale system

Your iron contains an anti-scale cartridge to reduce scale deposits.

This considerably prolongs the operational life of your iron.

The anti-scale cartridge is an integral part of the water tank and does not need to be replaced.

### 16 • Self Clean function

(prolongs the life of the iron)

The Self Clean function flushes dirt and scale particles out of the steam chamber.

**IMPORTANT** Do not use descaling agents, as these damage the lining of the steam chamber and so may impair the steam function.

Fill the water tank with tap untreated water up to the max mark and heat the iron to the  temperature. Unplug the iron and hold it over a sink horizontally. Hold the steam control into the Self Clean position (fig.5) : steam will now begin to build up. After a few seconds water will emerge from the soleplate, rinsing dirt and scale particles out of the steam chamber.

Move the steam control to  position after approx. 1 minute. Plug in the iron and allow the iron to heat up again. Wait until the remaining water has evaporated. Unplug from the mains and allow the iron to fully cool down.

When cool, the soleplate can be wiped with a damp cloth.

**TIP** Use the Self Clean function approx. every 2 weeks. If the water is very hard, clean the iron weekly.

## 17 • Cleaning the iron

When the appliance has cooled down, wipe it down with a damp cloth or sponge, as required.

Remove the dirt from the soleplate with a damp cloth or sponge.

**IMPORTANT** Do not use sharp or abrasive cleaning agents or objects to clean soleplate and other parts of the iron. If the appliance has been standing unused for long periods, use the Self Clean function (see § 16).

## PROBLEMS?

Problems	Cause	Solution
The iron is plugged in, but the soleplate of the iron remains cold.	No mains supply.	Check that the mains plug is properly inserted or try plugging the iron into a different socket.
	Temperature control set too low.	Set the temperature control to a higher temperature.
	The automatic electronic cut-out* is active.	Move your iron.
Thermostat control light* or the yellow led* goes on and off.	This is normal.	When the thermostat control light* or the yellow led* goes on and off the iron is heating up. As soon as the thermostat control light* goes off or the green led* lights up the set temperature has been reached.

None or too little steam is being emitted.	Steam control set on dry position  .	Turn the steam control to the required setting area.
	Not enough water in the water tank.	Fill the water tank.
	Anti-Drip* is active (§ 11).	Wait for the soleplate to reach the correct temperature.
Brown streaks come through the holes in the soleplate and stain the linen.	Residues in the steam chamber or on the soleplate.	Use the Self Clean function then clean your iron.
	Use of chemical descaling agents.	Do not add any descaling agents to the water in the water tank. Use the Self Clean function and clean your iron.
	Fabric fibres have accumulated in the holes of the soleplate and are burning.	Clean the soleplate with a non-metallic sponge. Vacuum the holes of the soleplate from time to time.
	Your linen is not rinsed sufficiently or you have ironed a new garment before washing it.	Ensure linen is rinsed thoroughly to remove any soap deposits or chemicals on new garments which may be sucked by the iron.
	Use of starch.	Always spray starch onto the reverse side of the fabric to be ironed and clean your iron soleplate.
	Pure distilled / demineralised or softened water is being used.	Only use untreated tap water or mix half tap water with half distilled/demineralised water. Use the Self Clean function and clean your iron.
Iron is leaking.	Overuse of shot of steam button.	Allow more time between each shot.
	Soleplate temperature too low .	Set the temperature control to a higher temperature.

If you are unable to trace the cause of the fault, contact an official Rowenta Customer Service Centre. The addresses are shown in the enclosed service centre address list. Helplines listed at the front of this leaflet.

Further hints and tips are obtainable from our homepage: [www.rowenta.com](http://www.rowenta.com).

Subject to modifications !

