

# Rowenta

## SELECTIUM

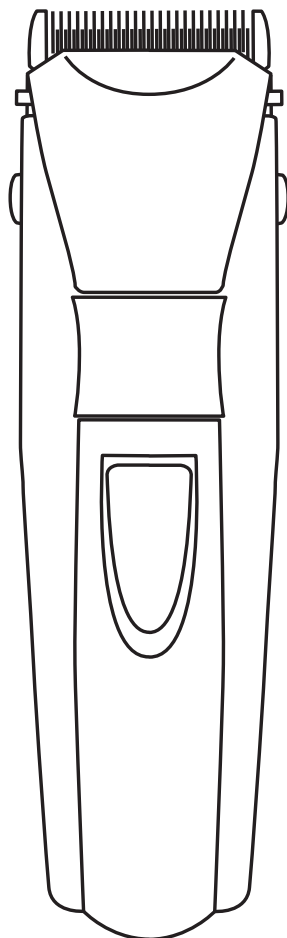

Gebrauchsanweisung  
Instructions for use  
Notice d'emploi  
Istruzioni per l'uso  
Modo de empleo  
Instruções de utilização  
Brugsanvisning  
Bruksanvisning  
Käyttöohje  
دليل الاستعمال

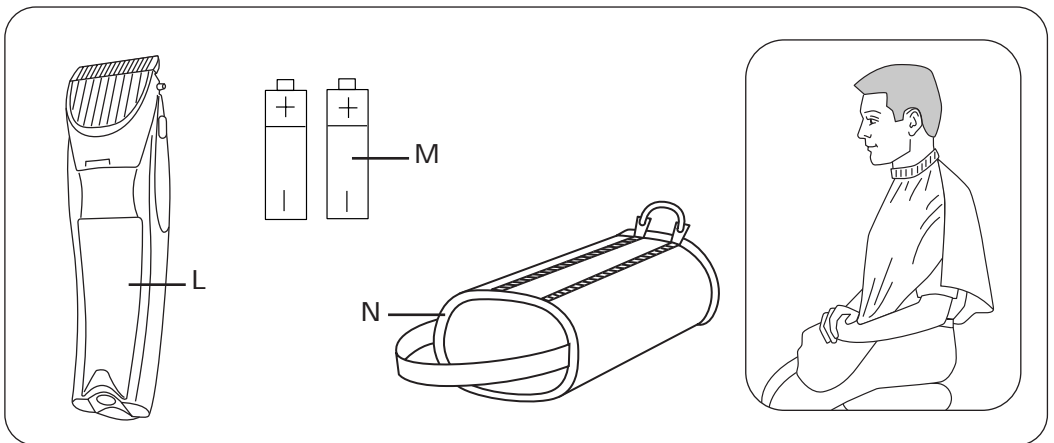
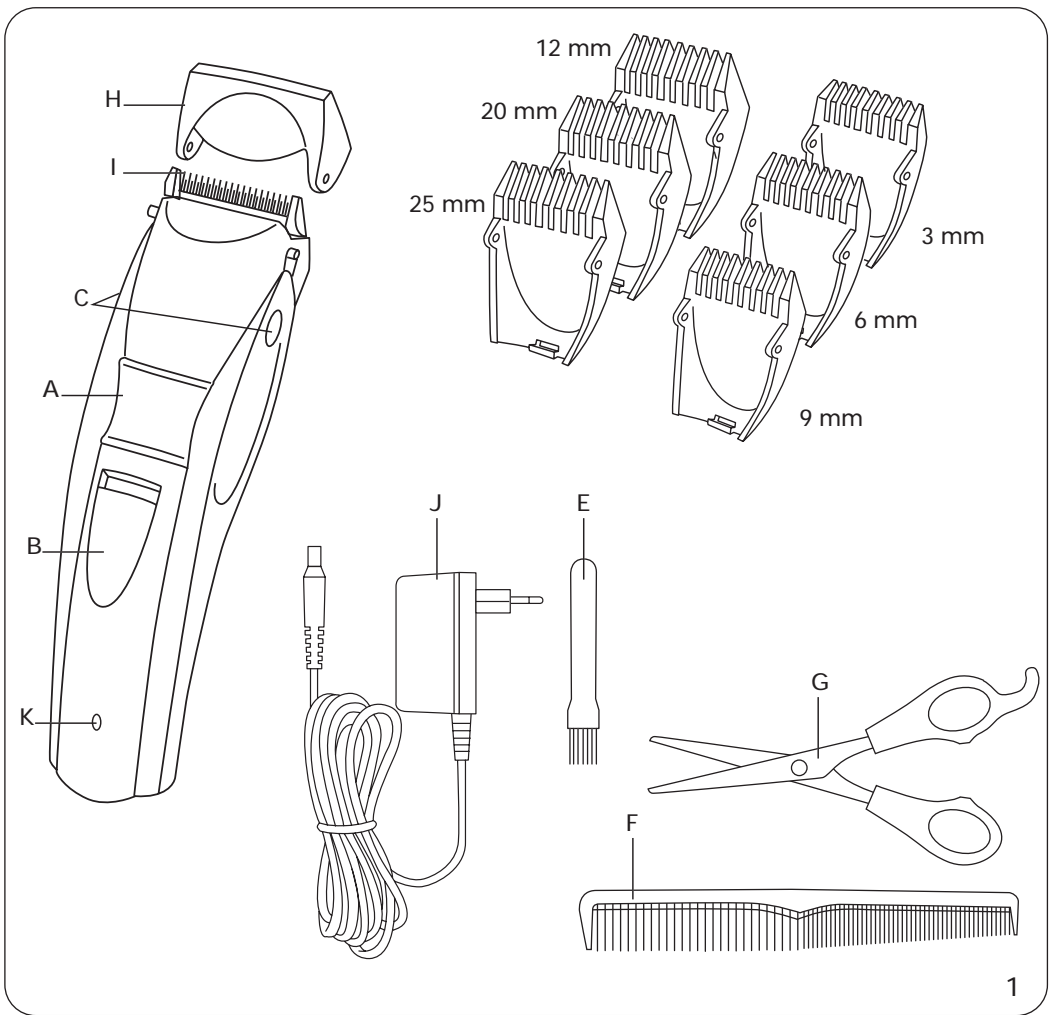

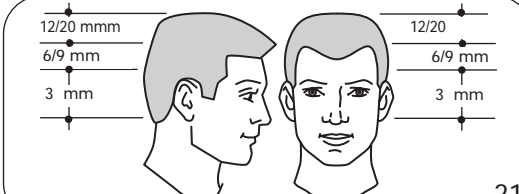
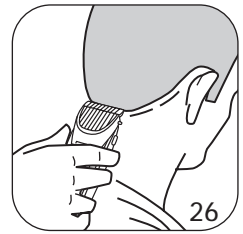
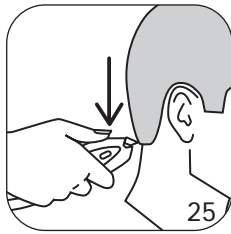
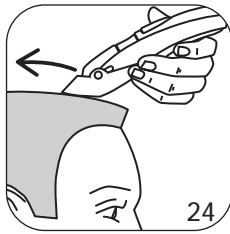
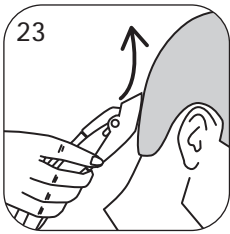
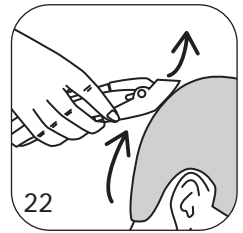
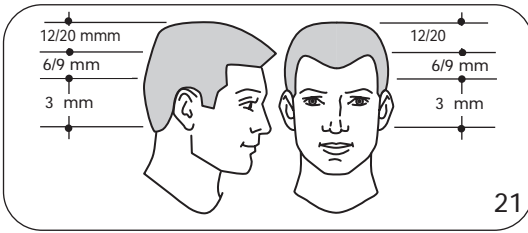
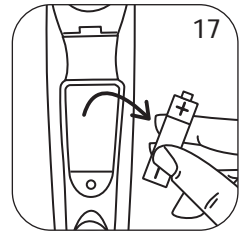
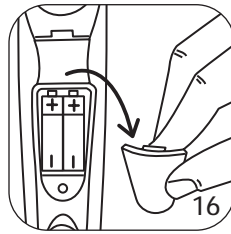
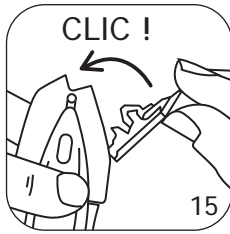
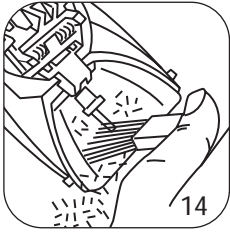
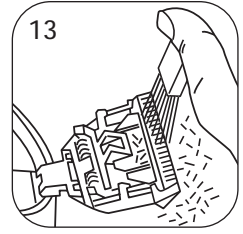
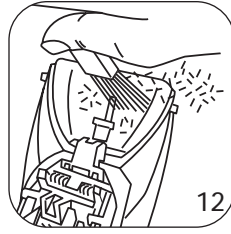
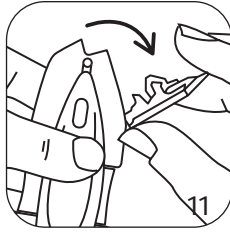
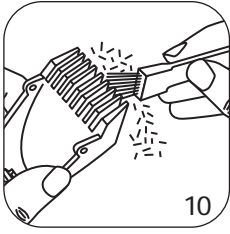
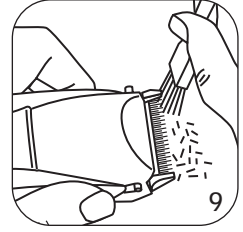
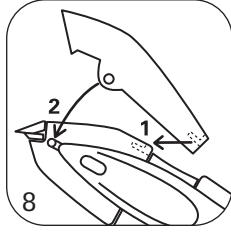
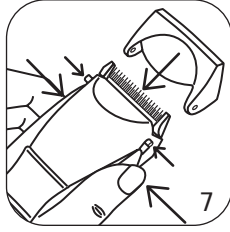
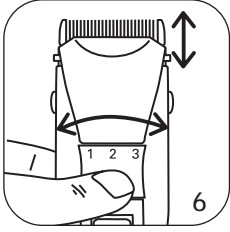
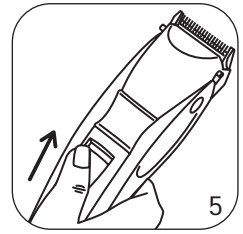
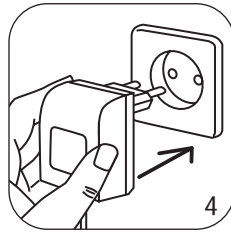
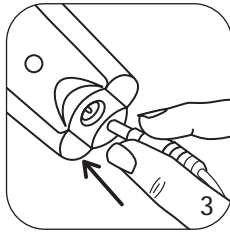
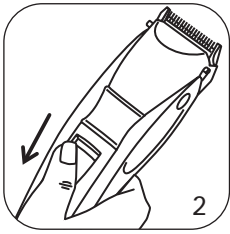

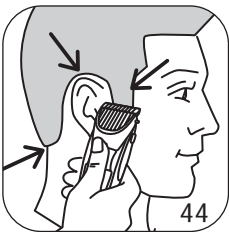
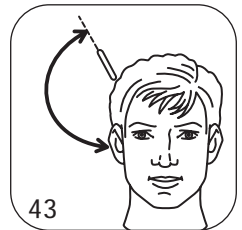
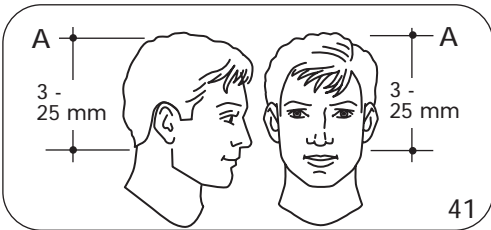
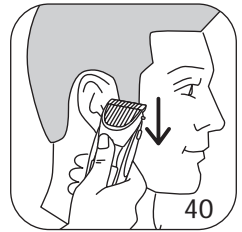
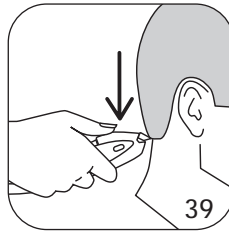
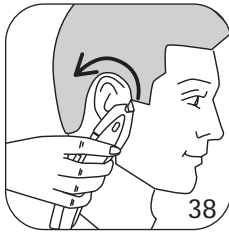
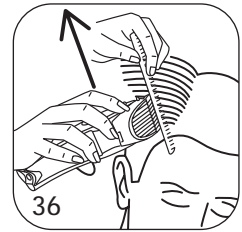
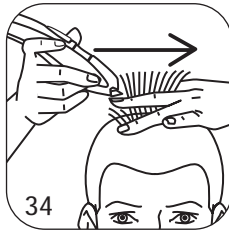
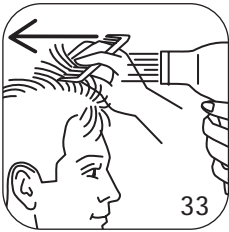
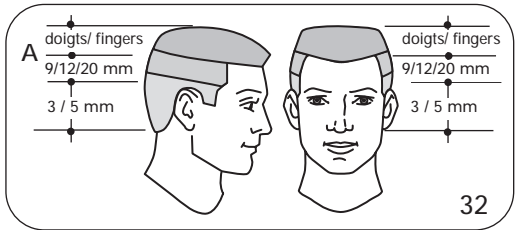
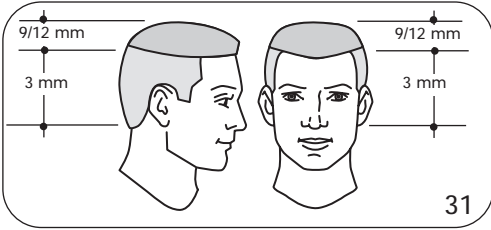
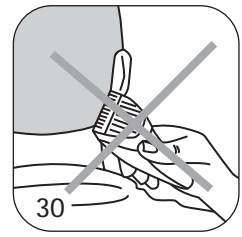
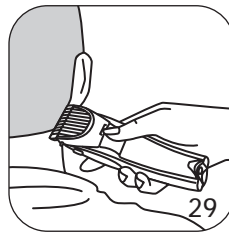
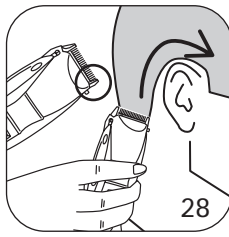
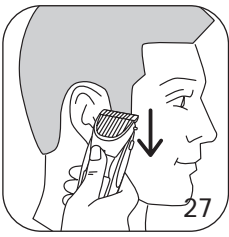

You have chosen this clipper to make short haircuts or general trimming easy. Its carefully monitored production process and precise adjustments for the length of the cut make it a quality professional tool.



**Read the instructions before using the appliance and avoid any danger caused by improper usage.**

## 1 - DESCRIPTION OF THE CLIPPER AND ITS ACCESSORIES

Mod. HC 190 / HC 200:

- A. Cutting wheel with precise adjustment system for the length of the cut.
- B. Start/Stop button.
- C. Side buttons for locking/unlocking the combs and the blade protector.
- D. Combs (3-6-9-12-20-25).
- E. Cleaning brush.
- F. Hairdressing comb.
- G. Pair of scissors.
- H. Blade protector.
- I. Cutting head.
- J. Adapter - 2.4V for mains supply model & 3V for rechargeable model.
- + book of instructions.

Rechargeable model only: (HC 200)

- K. Battery charge light.
- L. Batteries.
- M. Battery catch-release cover.
- N. Storage case.

## 2 - FIRST TIME USE

Voltage:

- Mains supply model: with adapter and input voltage of 230 V 50 Hz, output voltage of 2.4 DC
- Rechargeable model: with voltage adapter: input 230 V 50 Hz, output voltage 3 V DC
- Your appliance is only designed to function at 230V.50Hz.
- Check that this voltage corresponds with that of your place of usage.

If you have chosen a rechargeable appliance, you can use it with the mains supply or in autonomous mode (cordless)

A - In mains supply mode: (models HC 190 / HC 200)

- Turn off the appliance: Start/Stop button in position O (Fig. 2)
- Plug the connector into the appliance (Fig. 3) and the adapter into the mains supply (Fig. 4)
- Start the appliance (Fig. 5)

There is no recharging during usage

B - In autonomous mode: (model HC 200 only)

- The appliance functions with 2 batteries
- Capacity: 1.2V / 600mA. (Per unit)
- Type: Ni -Cd

### IMPORTANT ADVICE:

To optimise the life-span of the batteries

- Before first-time usage, charge the appliance using the adapter for 14 hours. For the next 3 times you use it, it is important to allow the battery to run down completely. A recharge time of 8 hours is recommended. When the battery recharge light is red, your appliance is charged
- Having unplugged the transformer, autonomy is approximately 50 minutes.

## IMPORTANT! In order to avoid damaging the batteries:

- Never charge for more than 20 hours
- Don't charge the batteries too prematurely: only charge them when the power of the appliance is clearly reduced or the appliance has not been used for more than 6 months



## 3 - GUARANTEE

Your appliance is guaranteed for one year, but incorrect connection to the power supply, use of accessories from another manufacturer or abnormal use of the appliance will render the guarantee null and void.

### SERVICE- SPARE PARTS. (U.K. ONLY)

Rowenta (U.K.) Ltd has a network of Service Agents throughout the country.

To telephone your nearest Rowenta Service Centre see enclosed Service Information leaflet. These Service Agents carry-out in-guarantee repairs (free of charge) and out of guarantee repairs (chargeable) on behalf of Rowenta. Should service be required, or the appliance appear faulty, consult your local Rowenta Service Agent in the first instance.

If a product develops a fault during the guarantee period it is the responsibility of the consumer to supply to the Service Agent proof of the date of purchase of the appliance (eg. Completed guarantee card and/or receipt showing the date of purchase).

### GUARANTEE (U.K. ONLY)

Details of the Rowenta guarantee are shown on the Guarantee Card enclosed with the appliance. This guarantee does not affect your statutory rights.

Should further information be required please see the enclosed Service Information leaflet.

## 4 - SECURITY DETAILS

### FOR MAINS SUPPLY AND RECHARGEABLE CLIPPERS

- Unplug the appliance before any handling operation (change of accessories, lubrication, opening of the cutting head, etc) and after usage.
- Any connection error can cause irreversible damage - uncovered by the guarantee.
- Do not use or recharge the clipper near water in bathtubs, wash basins, showers or other water sources.
- This appliance is reserved for domestic usage only. Do not use for more than 10 minutes continuously.
- For the rechargeable model, use batteries of type Ni-Cd or Ni-MH only.
- **Important: the clipper and the adapter must not be submerged or wet in any way.**
- Do not leave the appliance for a prolonged period at a temperature below 0°C and above 40°C (by a window in the sun for example)
- Do not expose the appliance over a lengthy period to the direct effects of the sun's rays.
- Do not use an electrical extension cable in your bathroom.
- Keep the cable, appliance and accessories away from any source of heat.
- **Never use the appliance in the event of functioning problems, or after it has been dropped (invisible damage can be a danger to your safety).**
- When the clipper is running it must not be brought into contact with eyelashes, clothing or any other object, so as to avoid any risk of injury or blockage.
- If several people use the clipper, appropriate cleaning of the cutting head is recommended.
- Careful attention is necessary when the appliance is used on or in the presence of children or disabled people.
- Never leave the clipper within the reach of children.
- Be careful when you use the clipper for the first time. Take your time. Keep your movements slow and controlled.
- Do not use the clipper on animals.
- Don't use the appliance:
  - On damaged skin.
  - if you suffer from skin infections: eczema, varicose veins, skin inflammation, beauty spots, acne, verrucas, birth marks, etc.
- This appliance can be dismantled using special tools, all maintenance operations should be carried out by the manufacturer, its customer service department or someone similarly qualified so as to avoid any danger.
- The cutting recommendations are given only as guidelines and do not commit ROWENTA to any responsibility in the event of undesired results



• For any operational faults, see paragraph "in the event of a problem" or contact our customer service or your retailer.



#### WIRING INSTRUCTIONS - FOR U.K. ONLY. SAFETY NOTES - FOR REWIREABLE OR MOULDED PLUG.

The mains lead of this appliance may be already fitted with a BS1363 13 A plug.

Should the fuse need to be replaced, a 13 A ASTA approved BS 1362 fuse must be used.

If your socket outlet is not suitable for the plug, then the plug must be removed (cut off if it is a moulded on plug) and an appropriate one fitted. Warning : dispose of a plug that has been cut from the power supply cord, as such a plug is hazardous if inserted in a live 13 A socket outlet elsewhere in the house.

Always replace the fuse cover after fitting a fuse. The plug must NOT be used if the cover is omitted or lost until a replacement is obtained - make certain that only the correct fuse cover is used and fitted.

For plugs with a detachable fuse cover the replacement must be the same as the colour insert in the base of the plug, or as directly by the embossed wording on the base of the plug.

If the detachable fuse cover is lost, a replacement may be purchased from a Service Centre (see enclosed Service Information leaflet). Information for supply may also be obtained from the plug manufacturer.

#### U.K. ONLY - FITTING A PLUG.

**Important:** the wires in the mains cord are coloured in accordance with the following code Blue, Neutral, Brown, live. Please read the instructions given below before connecting the cord to a plug. If the doubt, please consult a qualified electrician.

As the colours of the wires in the mains lead of this appliance may not correspond with the coloured markings identifying the terminals in your plug, proceed as follows:

- the wire which is coloured BLUE must be connected to the terminal which is marked with the letter « N » or coloured BLACK ;
- the wire which is coloured BROWN must be connected to the terminal which is marked with the letter « L » or coloured RED.

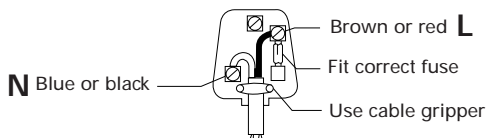

Neither core is to be connected to the earth terminal of a three-pin plug. This appliance requires a 13 A fus ASTA approved to BS 1362.

## 5 - CUTTING WHEEL WITH 5 POSITIONS FOR A PERFECT FINISH

- Your clipper is fitted with a cutting wheel that can adjust the cutting length with great precision
- To obtain and hold one of the positions: turn the cutting wheel the desired number of notches (Fig. 6)

Positions of the cutting wheel	Length of cut in mm
1	0,8
2	1,1
3	1,4
4	1,7
5	2,0

## 6 - POSITIONING THE BLADE PROCTECTOR

- Hold down the buttons on the side of the clipper and fit the blade protector (Fig. 7)
- Let go of the buttons, with the attachment pins fixed in the side openings of the blade protector
- To remove it, do the opposite.

## 7 - POSITIONING THE COMBS

- Hold down the 2 buttons on the side of the clipper. Fit the rear hook of the comb into the notch on the back of the clipper (Fig 8), bring the 2 holes on the side of the comb even with the pins.
- Let go of the buttons, with the attachment pins fixed in the side openings of the comb.
- To remove the comb, do the opposite.

## 8 - MAINTENANCE



- The clipper needs very little maintenance. You can clean it with a slightly damp cloth
  - It is recommended that you clean the cutting head after each usage with the brush (Fig. 9). For this turn the cutting wheel to position 5
  - To clean the comb, remove it and clear away the hair with the brush (Fig. 10). For a very detailed clean, push the cutting head back (Fig. 11). Remove the hair with the brush (Fig. 12-13-14) then replace the cutting head:
- Important, make sure the cutting head is properly attached when you refit it (Fig. 15)**

### CHANGING THE BATTERIES :

The appliance is fitted with two Ni - Cd batteries  
If it is no longer possible to charge your clipper, you can change them  
Only use Ni - Cd or Ni - MH batteries. **DO NOT USE NON STORAGE BATTERIES** (they can melt).

- Unplug the appliance
- Let the motor run until it stops completely
- Open the catch-release at the back of the appliance ( Fig. 16)
- Replace the old batteries with the new ones (Fig. 17) Respect the polarity of the batteries indicated in the battery compartment.
- Close the catch-release.
- To charge the batteries, go back to paragraph "First time use"

**DANGER!** Injuries as a result of the batteries running.

The batteries contain substances that in contact with the skin or inhaled can provoke injuries. Only remove the batteries that have run with rubber gloves and throw them out in a closed container. (see paragraph "Protection of the Environment).

## 9 - LUBRICATION

Auto-lubricating blades = no more lubricating needed !

## 10 - PROTECTION OF THE ENVIRONMENT

Recycling of the batteries 

This appliance contains Ni - Cd batteries. As a consumer the law obliges you to place these batteries in a specially designed waste recovery centre (waste collection centre). Do not throw away these batteries with the household waste.

## 11 - IN THE EVENT OF PROBLEMS

- The clipper won't start (rechargeable model in autonomous mode): **have you recharged the batteries?**
- The comb won't fit onto the clipper: **have you respected the assembly instructions?** (see paragraph 6)
- Your clipper no longer has enough autonomy: **have you charged the batteries enough?** If yes, change them.

## 12 - TIPS FOR A SUCCESSFUL HAIRCUT

- Use the hair trimmer on clean, dry hair
- Dry the hair in the direction of the hairstyle you wish to obtain
- Position the person whose hair you are going to cut in such a way as to be able to see the top of his/her head (Fig. 20)
- Before starting a cut, examine the hollows and bumps on the head, which are often located at the nape of the neck (if you place the trimmer directly against a bump, you will obtain a lighter area).
- **At the beginning, only cut a small quantity of hair, until you are familiar with the length left by each comb.**
- **Never stop the trimmer in mid-stroke.**
- **Start with the comb with the highest number (i.e. the one which leaves the most hair) before using another comb.**



## Key:

✂✂✂ = easy cut

✂✂✂ = cut which requires some practice

✂✂✂ = difficult cut

## 13 - FOR A SUCCESSFUL ROUND CREW CUT ✂

### BASIC METHOD.

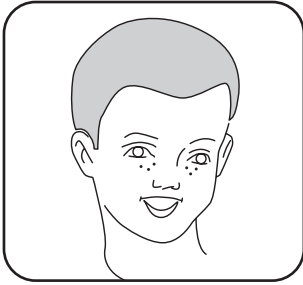

With this method, the cut follows the shape of the skull.

- **Combs necessary for this cut : 3-6-9-12-20 mm according to the required length (fig.21).**
- Do not forget to change the comb as you progress through the hair.

#### 1st STAGE : THE CUT.

##### a) Nape

- Brush the hair.
- Begin by cutting the hair at the nape upwards, using comb 20 mm.
- Hold the trimmer firmly against the hair, with the comb's teeth pointing slightly upwards (fig. 22).

- Slowly raise the hair trimmer towards the top and outside of the hair, cutting only a small amount of hair at a time (fig. 23).
  - Once the hair at the nape has been evenly cut using comb 20 mm, replace the removable comb in order to obtain the required length and repeat the first 3 operations.
  - Stop the cut at regular intervals, comb the hair and check the result.
- ##### b) Sides and top
- Repeat the above operations to cut the sides.
  - Change the comb as you change areas (see fig. 21).
  - For the top, use the same technique, cutting the hair from the forehead to the crown, against the "lie of the hair" (fig. 24). Then, level off to match the sides.

#### 2nd STAGE : CONTOURS AND FINISH

##### a) Nape and sideburns

- Comb the hair.
- Turn the cutting wheel to position 1 (very short).
- Move the cutting height lever back to 'very short' position (lever released).
- Cut the hair from the edge of the cut, moving downwards, holding the trimmer upturned and right angles to the head. Use short strokes (figs. 25 and 26).
- Repeat these operations for the sideburns (fig. 27).

##### b) Around the ears

- Comb thoroughly the hair around the edge of the ear; take off the removable comb.
- Hold the trimmer on the edge, but only use a corner of the trimmer, following slowly the required contour and following the direction of the cut (fig. 28).

#### Tips :

- When using the hair trimmer without a removable comb, make sure that you use controlled, light movements.
- For the finishing strokes, ensure that the hair trimmer remains at right angles to the skin, in order to avoid injury (fig. 29 and 30).

## 14 - FOR A SUCCESSFUL AMERICAN-STYLE CUT ✂✂✂



A very short cut on the sides and the nape, and very short on the top.

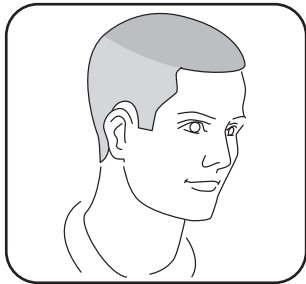

- Combs necessary for this cut : 3-6-9-12 mm according to the required length (fig. 31).
- Do not forget to change combs as you progress through the hair.

### 1st STAGE : THE CUT

- To cut the hair on the sides and the nape, see the "Round Crew cut" chapter. At the end, use 3 mm comb to obtain a shaven cut.
- For the top, at the locations indicated by the zone change lines (see fig. 31), use comb 9 or 20 mm, in order to keep the length longer. Cut the hair from front to back.

### 2nd STAGE : CONTOURS AND FINISH

- Consult the "Contours and finish" paragraph in the "Round Crew cut" section.

## 15 - FOR A SUCCESSFUL COMB OR FINGER CUT (SQUARE CREW CUT) ✂✂✂

This cut provides a flat surface on the top of the head.

- Combs necessary for this cut : 3, 20 mm according to the required length + fingers (fig. 32).
- Do not forget to change combs as you progress through the hair.

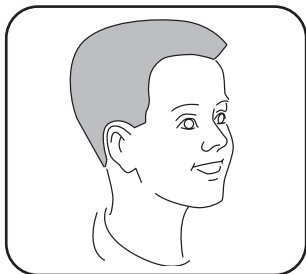

### 1st STAGE : THE CUT

- To obtain a successful square crew cut, preliminary drying is the most important factor (fig. 33).
- Dry the hair against the lie in order to raise the crew cut.
- Begin the cut on the sides and the nape, using the combs specified in fig. 32 (for the cut procedure, consult the chapter entitled "Round crew cut").
- To obtain a flat top, use the normal comb or, failing that, your fingers (fig. 34 and 35).

- take off the removable comb from the hair trimmer,

- using the styling comb (or your fingers), raise a small strand of hair (the hair must be in a vertical position in relation to the skull),
- move the comb or your fingers along the strand until you obtain the required length,
- use the hair trimmer to cut the hair sticking out of the comb or your fingers, using the latter as a support,
- the height of the last strand cut is used as a guide for the subsequent strands,
- continue in this way, strand by strand, moving gradually from the back to the top of the skull, and then to the front.
- comb the hair regularly to remove the cut hair and check the condition of the cut,
- to obtain a perfect transitional area (A on fig. 32), between the top and side hair, slightly tilt the flat comb and cut the excess hair (fig. 36).

### 2nd STAGE : CONTOURS AND FINISH

- See the paragraph entitled "Contours and finish" in the "Round Crew cut" section.

## 16 - FOR A SUCCESSFUL TRIM ✂

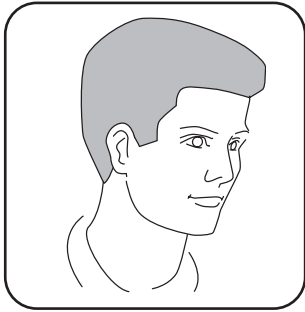

### 1st STAGE : THE CUT

To ensure a consistent and Professional result when cutting the excess hair.

For this cut, work without a removable comb.

#### a) Around the ears (fig. 37 and 38).

- Comb the hair in the required style.
- Place the upturned hair trimmer between the sideburns and the ear and make sure that the blade angle is placed at the roots of the hair (only use the tip of the hair trimmer).
- Move the trimmer slowly above, around and behind the ears.

#### b) Nape (fig. 39).

- For the nape, hold the hair trimmer upturned, pressing lightly against the hair.

- Proceed as shown in the sketch below, moving downwards, in short strokes.

#### c) Sideburns (fig. 40).

Move the trimmer downwards, holding it upturned, with the cut line at right angles to the head. Proceed in short strokes.

## 17 - FOR A SUCCESSFUL "SHORT BACK AND SIDES"



With this cut, on the sides and nape only, your hair is kept long on the top (fig. 41).

- Combs necessary: 3 or 25 mm, according to the required length (fig. 41).

### 1st STAGE: THE CUT

- Cut the hair on the nape of the neck and the sides (following the procedure described in the "Round Crew cut" paragraph), using the hair trimmer fitted with comb 3 or 25 mm (according to the required length), up to point A (see sketch).
- Starting from point A (located a few cm above the ear) (fig. 42), use a flat comb to obtain a perfectly clean line.

Tilt the comb in relation to the skull (fig.43) and cut the hair exceeding the comb, using the hair trimmer without its

removable combs (use this comb as a guide) (fig. 42).

- Do not cut the hair on the top.

### 2nd STAGE: CONTOURS AND FINISH

- See the "Contours and finish" chapter in the "Round Crew cut" section.

## 18 - HOW TO CUT A BEARD?

- For a beard in its initial stages, use the 5 positions of the fine adjustment cutting wheel (from 0.8 to 2mm)
- For all other types of beard, use the different combs provided

### 1st STAGE: THE CUT

- Important!: begin by using the comb set at the highest setting (before using another comb)
- Begin the cut under the chin. Move the clipper upwards and towards the sides, symmetrically (Fig. 45)

### 2nd STAGE: CONTOURS AND FINISHES

- Cut the hair at the edge of the beard keeping the clipper turned over and perpendicular, moving downwards. Use small strokes.