



# System Control

## Installation, Operation & Service Manual



### **WARNING**

Improper installation, adjustment, alteration, service or maintenance can result in death, injury or property damage. Read the Installation, Operation and Service Manual thoroughly before installing or servicing this equipment.

Installation must be done by a contractor qualified in the installation and service of gas-fired heating equipment or your gas supplier.

### **Installer**

Please take the time to read and understand these instructions prior to any installation. Installer must give a copy of this manual to the owner.

### **Owner**

Keep this manual in a safe place in order to provide your serviceman with necessary information.

**Roberts-Gordon LLC**  
 1250 William Street  
 P.O. Box 44  
 Buffalo, New York 14240-0044  
 Telephone: 716.852.4400  
 Fax: 716.852.0854  
 Toll Free: 800.828.7450

[www.rg-inc.com](http://www.rg-inc.com)  
[www.radiantheaters.com](http://www.radiantheaters.com)



---

## TABLE OF CONTENTS

|  |           |
|--|-----------|
| <b>SECTION 1: Introduction</b> .....   | <b>1</b>  |
| 1.1 Safety .....   | 1         |
| 1.2 What is a ROBERTS GORDON® System Control? .....                                  | 1         |
| 1.3 Electrical Requirements .....  | 1         |
| 1.4 Check Installation Materials .....   | 1         |
| <b>SECTION 2: Specifications</b> .....   | <b>3</b>  |
| 2.1 Material Specifications.....   | 3         |
| 2.2 Electrical Specifications.....   | 3         |
| 2.3 Pump Specifications .....  | 3         |
| 2.4 Burner Electrical Ratings .....  | 4         |
| 2.5 Outside Air Supply Blower Electrical Ratings .....                               | 4         |
| 2.6 Indicator Lights .....   | 4         |
| 2.7 Terminal Block Guide.....  | 4         |
| <b>SECTION 3: Installation</b> .....   | <b>5</b>  |
| 3.1 Preparation .....  | 5         |
| 3.2 Installing the System Control Panel .....  | 5         |
| 3.3 Select the External Wiring Diagram for the<br>Installation.....                  | 5         |
| 3.4 System Configuration.....  | 6         |
| <b>SECTION 4: Typical External Wiring Diagrams</b> .....                             | <b>7</b>  |
| 4.1 EP-100 or EP-201 120 V 1 Ø Pump External<br>Wiring Diagram.....                  | 7         |
| 4.2 EP-201 or EP-301 230 V 1 Ø External<br>Wiring Diagram.....                       | 8         |
| 4.3 EP-203 or EP-303 208 - 230 V (or 460 V) 3 Ø Pump<br>External Wiring Diagram..... | 9         |
| 4.4 Outside Air Blower External Wiring Diagram .....                                 | 10        |
| <b>SECTION 5: Troubleshooting</b> .....  | <b>12</b> |
| 5.1 Sequence of Operation.....   | 12        |
| <b>SECTION 6: Replacement Parts</b> .....  | <b>14</b> |
| 6.1 Replacement Parts Instructions.....  | 15        |
| <b>SECTION 7: The ROBERTS GORDON® System Control<br/>        Warranty</b> .....      | <b>17</b> |

© 2009 Roberts-Gordon LLC

All rights reserved. No part of this work covered by the copyrights herein may be reproduced or copied in any form or by any means - graphic, electronic, or mechanical, including photocopying, recording, taping or information storage and retrieval systems - without the written permission of Roberts-Gordon LLC.



---

## TABLE OF FIGURES

|   |    |
|---|----|
| Figure 1: Panel Layout .....  | 3  |
| Figure 2: Terminal Block Guide.....   | 4  |
| Figure 3: Mounting Hole Layout.....   | 5  |
| Figure 4: System Configuration.....   | 6  |
| Figure 5: External Wiring Diagram ROBERTS GORDON®<br>EP-100 and EP-201 120 V 1 Ø Pump .....                           | 7  |
| Figure 6: External Wiring Diagram ROBERTS GORDON®<br>EP-100, EP-201 or EP-301, 230 V 1 Ø Pump .....                   | 8  |
| Figure 7: External Wiring Diagram ROBERTS GORDON®<br>EP-203 or EP-303, 208 - 230 V (or 460 V)<br>3 Ø Pump.....        | 9  |
| Figure 8: External Wiring Diagram ROBERTS GORDON®<br>EP-100 or EP-201 120 V 1 Ø Pump with Outside<br>Air Blower ..... | 10 |
| Figure 9: System Control Troubleshooting Chart .....  | 13 |
| Figure 10: System Control Internal Components Diagram.....  | 14 |



## SECTION 1: INTRODUCTION

### 1.1 Safety



Your Safety is Important to Us! This symbol is used throughout the manual to notify you of possible fire, electrical or burn hazards. Please pay special attention when reading and following the warnings.

Installation, service and annual inspection of controller must be done by an electrician qualified in the installation and service of control systems for heating equipment.

Installation, service and annual inspection of heater must be done by a contractor qualified in the installation and service of gas or oil fired heating equipment.

Read this manual carefully before installation, operation, or service of this equipment.

For optimum heater performance and safe heating conditions, inspect and maintain heater(s) before every heating season as necessary. Also, know and maintain heater clearances to combustibles, see heater Installation, Operation and Service Manual for further details. If you require additional manuals, contact your ROBERTS GORDON® independent distributor or Roberts-Gordon LLC at (716) 852-4400, (800) 828-7450 or online at [www.rg-inc.com](http://www.rg-inc.com).

### 1.2 What is a ROBERTS GORDON® System Control?

The ROBERTS GORDON® System Control is an electronic controller designed for the control of CORAYVAC® and VANTAGE® NP (multiburner only) systems.

The System Control is capable of giving four zones of burners' temperature control and power. The control will also give power output to as many as two pumps, provided that the load is not greater than 20 A and 1 Ø. For additional electrical specifications see *Page 3, Section 2.2*.

### 1.3 Electrical Requirements

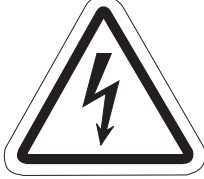
|  |
|--|
| <b>⚠ DANGER</b>  |
|   |
| <b>Electrical Shock Hazard</b>   |
| <b>Disconnect electric before service or maintenance.</b>                            |
| <b>Control must be connected to a properly grounded electrical source.</b>           |
| <b>Failure to follow these instructions can result in death or electrical shock.</b> |

Failure to comply with the installation instructions will invalidate the limited warranty set out on *Page 17, Section 7*.

The cable used for all wiring must be rated for 600 V.

The system control, burners, pump and outside air blower must be electrically grounded in accordance with the following:

United States: Refer to National Electrical Code®, NFPA 70 - latest revision. Wiring must conform to the most current National Electrical Code®, local ordinances and any special diagrams furnished.

Canada: Refer to Canadian Electrical Code, CSA C22.1 Part 1 - latest revision.

### 1.4 Check Installation Materials

Before proceeding with the installation of the ROBERTS GORDON® System Control, check the following points:

#### 1.4.1 Thermostats

Electronic 24 Vac thermostats and mechanical thermostats with heat anticipator can be used. The system control offers a 24 Vac power supply to power electronic thermostats.

Roberts-Gordon offers a selection of low voltage thermostats approved for use with the system control.

The thermostats measure the air temperature in the building. It is important that the thermostat is located in an area within the heated zone at occupant level. Do not place thermostat in an area shaded from the low-intensity, infrared heating system.

### 1.4.2 Electrical Installation Materials

120 V, 60 Hz, 1 Ø, 20 A, power supply to the control panel must be installed in accordance with the most current National Electrical Code®, local codes and any site specific diagrams.

Total load powered by the panel must not exceed 20 A. Loads totaling more than 20 A must be powered from an additional power supply circuit by the use of a load relay package.

### 1.4.3 Outside Air Supply Blower

If used, the optional outside air blower is to be controlled in parallel with the pump. The blower incorporates a pressure switch which must be wired in series with the pressure switch on the pump. The load relay package may be required with the blower. See Page 10, Figure 8 for wiring detail.

### 1.4.4 Pressure Switch

A pressure switch (P/N 90430600K), is required for installation on the inlet of the pump. This switch is required to interlock the operation of the pump with the control panel.

## **⚠ CAUTION**

### **Product Damage Hazard**

**Pressure switch must be installed on all ROBERTS GORDON® systems to ensure safety and operation.**

**System will not operate without pressure switch.**

**Failure to follow these instructions can result in product damage.**



## SECTION 2: SPECIFICATIONS

FIGURE 1: Panel Layout

**2.1 Material Specifications**

Enclosure Material: Metal

Weight: 6.8 lbs

Dimensions: 10.2" x 11.4" x 2.8"  
(25.4 x 29.0 x 7.1 cm)

Protection: Rating IP20

**2.2 Electrical Specifications**

Supply: 120 V, 60 Hz, 1 Ø, 20 A

Zone Relay: Single pole 20 A, 120 Vac  
(resistive)Pump Relay: Single pole 20 A, 120 Vac  
(resistive) 1 HP motor rated.

Thermostats: Low voltage 24 Vac

**2.3 Pump Specifications**

| Pump Model | HP  | Full Load Current |                 |               |           |
|------------|-----|-------------------|-----------------|---------------|-----------|
|            |     | 120 V 1 Ø         | 208/230 V 1 Ø   | 208/230 V 3 Ø | 460 V 3 Ø |
| EP-100     | 1/3 | 4.8 A             | N/A / 2.4 A     | -             | -         |
| EP-201     | 3/4 | 6.6 A             | N/A / 3.3 A     | -             | -         |
| EP-203     | 3/4 | -                 | -               | 2.4 A / 2.2 A | 1.1 A     |
| EP-301     | 2   | 23 A              | 12.8 A / 11.9 A | -             | -         |
| EP-303     | 2   | -                 | -               | 5.5 A / 5.2 A | 2.6 A     |

### 2.4 Burner Electrical Ratings

CORAYVAC® burners: 120 V, 60 Hz, 1 Ø 0.3 A

VANTAGE® NP (multiburner only) burners: 120 V, 60 Hz, 1 Ø 0.2 A

### 2.5 Outside Air Supply Blower Electrical Ratings

Outside air supply blower (P/N 90707501) has a full load rating of 1.6 A when supplied by a 120 V, 60 Hz, 1 Ø power source.

### 2.6 Indicator Lights

See Page 3, Figure 1.

1. LINE POWER, when lit, indicates power is supplied to the panel.
2. PUMP POWER 1, when, lit, indicates the relay for power to pump 1 is energized.
3. PUMP POWER 2, when, lit, indicates the relay for power to pump 2 is energized.
4. PRESSURE SWITCH 1, when lit, indicates that pressure switch 1 is closed. When blinking, indicates that the system is in lockout.
5. PRESSURE SWITCH 2, when lit, indicates that pressure switch 2 is closed. When blinking, indicates that the system is in lockout.
6. ZONE, when lit, indicates which zone relay is energized.

### 2.7 Terminal Block Guide

Figure 2 is a guide to the terminal abbreviations.

**FIGURE 2: Terminal Block Guide**

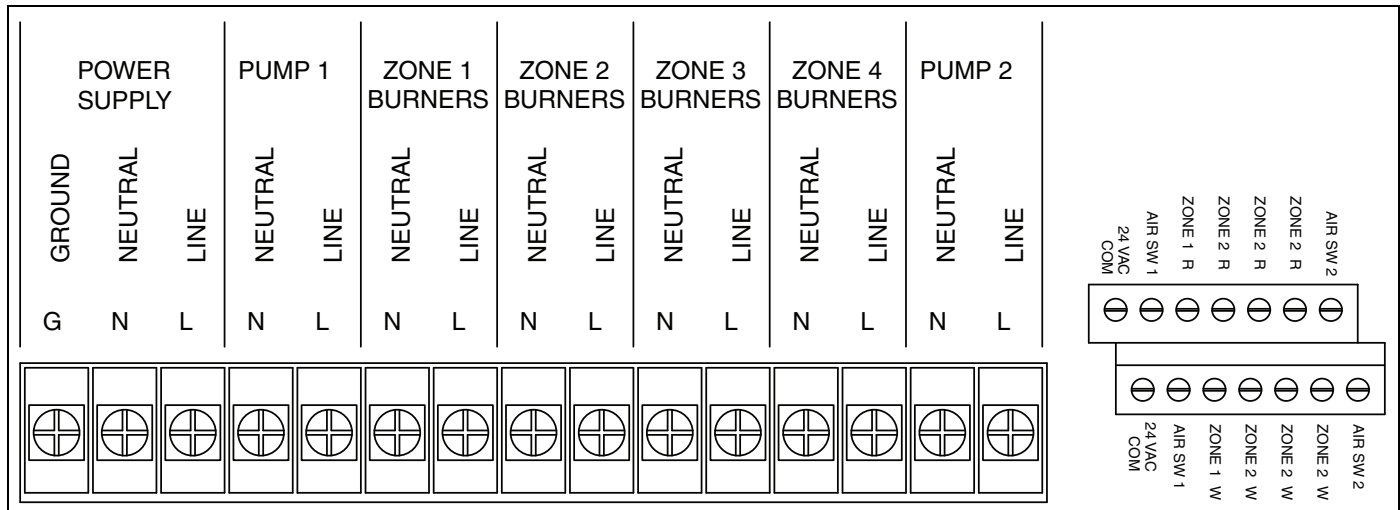

## SECTION 3: INSTALLATION

**⚠ DANGER**



**Electrical Shock Hazard**

**Disconnect electric before service or maintenance.**

**Control must be connected to a properly grounded electrical source.**

**Failure to follow these instructions can result in death or electrical shock.**

Installation of the System Control and the associated external electrical wiring must be completed by an electrician qualified in the installation of control systems for heating equipment.

### 3.1 Preparation

Before installing the System Control, observe the following:

**3.1.1** Ensure that you have a copy of the site layout for the project that identifies clearly the separate zones.

**3.1.2** Read *Page 1, Section 1.4* carefully to ensure the correct installation materials are available.

### 3.2 Installing the System Control Panel

**3.2.1** Choose a mounting location for the System Control. It is advisable to choose a visible location near the pump.

**Do not mount System Control outdoors or in an area with moisture spray, excessive moisture or humidity. To avoid damage from possible drips, do not mount controller directly beneath pump.**

**3.2.2** Remove the cover of the System Control by removing the four securing screws.

**3.2.3** Place the cover and the hardware in a safe place for refitting after the external wiring connections have been made.

**3.2.4** Position the mounting hole location of the System Control per *Figure 3*.

**3.2.5** Remove the knockouts required for the conduit entry into the System Control panel. The knockouts are on the top of the system control case. If the knockouts are required to be on the bottom the case can be rotated 180°.

**3.2.6** When the case is rotated 180°, the LED status circuit card needs to be rotated so that the LED's match the upright cover panel. Remove the LED status circuit card by squeezing each standoff gently with pliers one at a time until it is loose. Rotate the circuit card so that it will line up with the upright cover and re-attach to the standoffs. The ribbon cable that connects the LED status circuit card to the circuit card assembly will have a twist in it. Use caution not to cause any creases or put any tension to the ribbon cable when rotating the circuit card.

**FIGURE 3: Mounting Hole Layout**

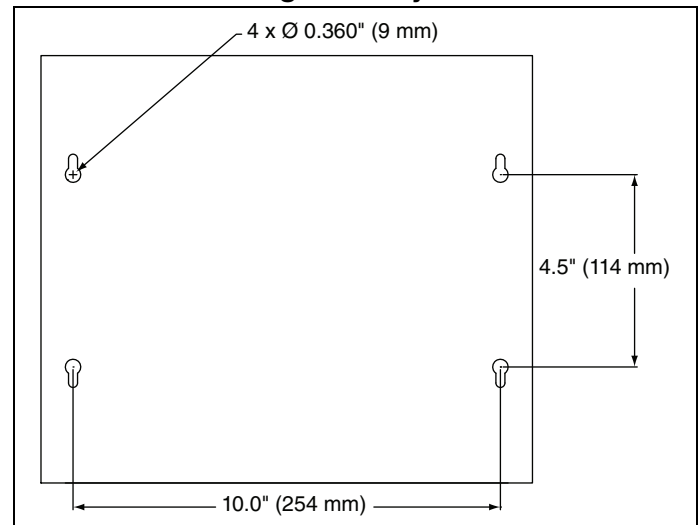

### 3.3 Select the External Wiring Diagram for the Installation

**3.3.1** Use *Page 7, Section 4* for the external wiring of the burners, thermostats and pressure switch.

**3.3.2** Use the table below to select the correct pump external wiring diagram.

| Pump   | Supply Voltage             | Page | Section | Figure |
|--------|----------------------------|------|---------|--------|
| EP-100 | 120 V 1 Ø                  | 7    | 4       | 5      |
| EP-100 | 208/230 V 1 Ø              | 8    | 4       | 6      |
| EP-201 | 120 V 1 Ø                  | 7    | 4       | 5      |
| EP-201 | 208/230 V 1 Ø              | 8    | 4       | 6      |
| EP-301 | 120/208 - 230 V 1 Ø        | 8    | 4       | 6      |
| EP-203 | 208 - 230 V (or 460 V) 3 Ø | 9    | 4       | 7      |
| EP-303 | 208 - 230 V (or 460 V) 3 Ø | 9    | 4       | 7      |

Roberts-Gordon LLC provides, at **an additional cost**, the following IEC contactor packages required for EP-100 and EP-201 208/230 V (1 Ø), EP-203 (3 Ø), EP-303 (3 Ø) and EP-301 (1 Ø) pumps.

For the EP-203 (3 Ø), EP-303 (3 Ø), EP-100, EP-201 and EP-301 208/230 V (1 Ø) pumps, use the 17 Amp contactor package (P/N 10050011).

For the EP-301 pumps that are operated with 120 V (1 Ø) use the 28 Amp contactor package (P/N 10050012). The contents are listed below:

| Contactor Packages |                                  |
|--------------------|----------------------------------|
| Part No.           | Description                      |
| <b>10050011</b>    | <b>Contactor Package 17A</b>     |
| 10001002           | Enclosure IEC metal 8X6X6 NEMA 1 |
| 90600200           | CONT 208-600 17A (A16-30-10-84)  |
| <b>10050012</b>    | <b>Contactor Package 28A</b>     |
| 10001002           | Enclosure IEC metal 8X6X6 NEMA 1 |
| 90600205           | CONT 208-600 28A (A26-30-10-84)  |

All pump motors are equipped with thermal overloads.

**3.3.3** If an outside air blower is to be used with any of the above options, See Page 10, Figure 8.

### 3.4 System Configuration

See Page 6, Figure 4 for details. Below the ribbon cable J2 connector, there are six configurable jumpers. They indicate whether the thermostat for each zone uses an anticipator. If the thermostat for that associated zone has an anticipator, then use a jumper to cover both pins for that zone. If the thermostat for the associated zone does not use an anticipator, then cover the right side pin only.

The bottom two jumpers are associated with Pump 2 operation. They indicate whether Pump 2 is active and which zones are associated with it. Pump 2 can only be associated with Zone 3 and/or Zone 4. To enable Pump 2, use a jumper to cover both pins for the zone(s) that will operate on Pump 2. To disable Pump 2, cover only the right side of the pin of zone 3 and 4.

**FIGURE 4: System Configuration**

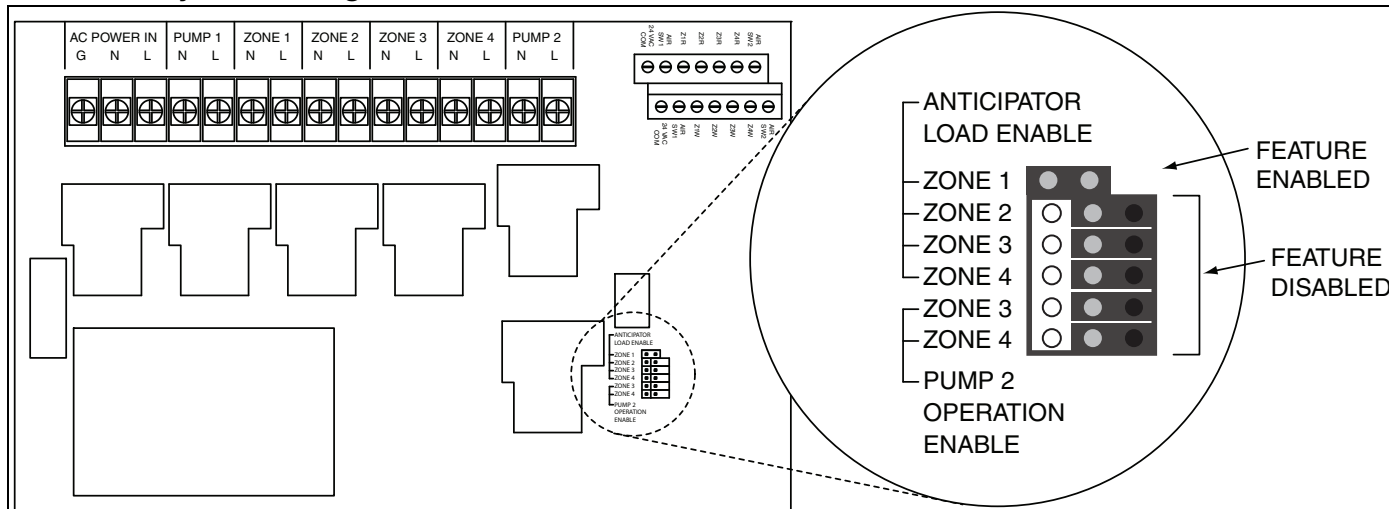

## SECTION 4: TYPICAL EXTERNAL WIRING DIAGRAMS

**⚠ DANGER**

**Electrical Shock Hazard**  
Disconnect electric before service or maintenance.

More than one disconnect switch may be required to disconnect electric to the unit.

Failure to follow these instructions can result in death or electrical shock.

## 4.1 EP-100 or EP-201 120 V 1 Ø Pump External Wiring Diagram

The external wiring diagram above shows the connections for four zones of system burners. System burners can be either CORAYVAC® or VANTAGE® NP (multiburner only).

The zones are connected to a single pump, unless zone 3 and/or zone 4 are selected to function with the optional pump 2. The external wiring diagram below shows connection to an EP-100 or EP-201 120 V 1 Ø pump.

## 4.1.1 External Wiring Connection Details

The cable used for all the wiring must be rated for line voltage up to 600 Vac.

The low voltage circuit conforms with Class 2 separation of circuit requirements. National Electrical Codes® for wiring class 2 low voltage circuits must be followed.

FIGURE 5: External Wiring Diagram ROBERTS GORDON® EP-100 and EP-201 120 V 1 Ø Pump

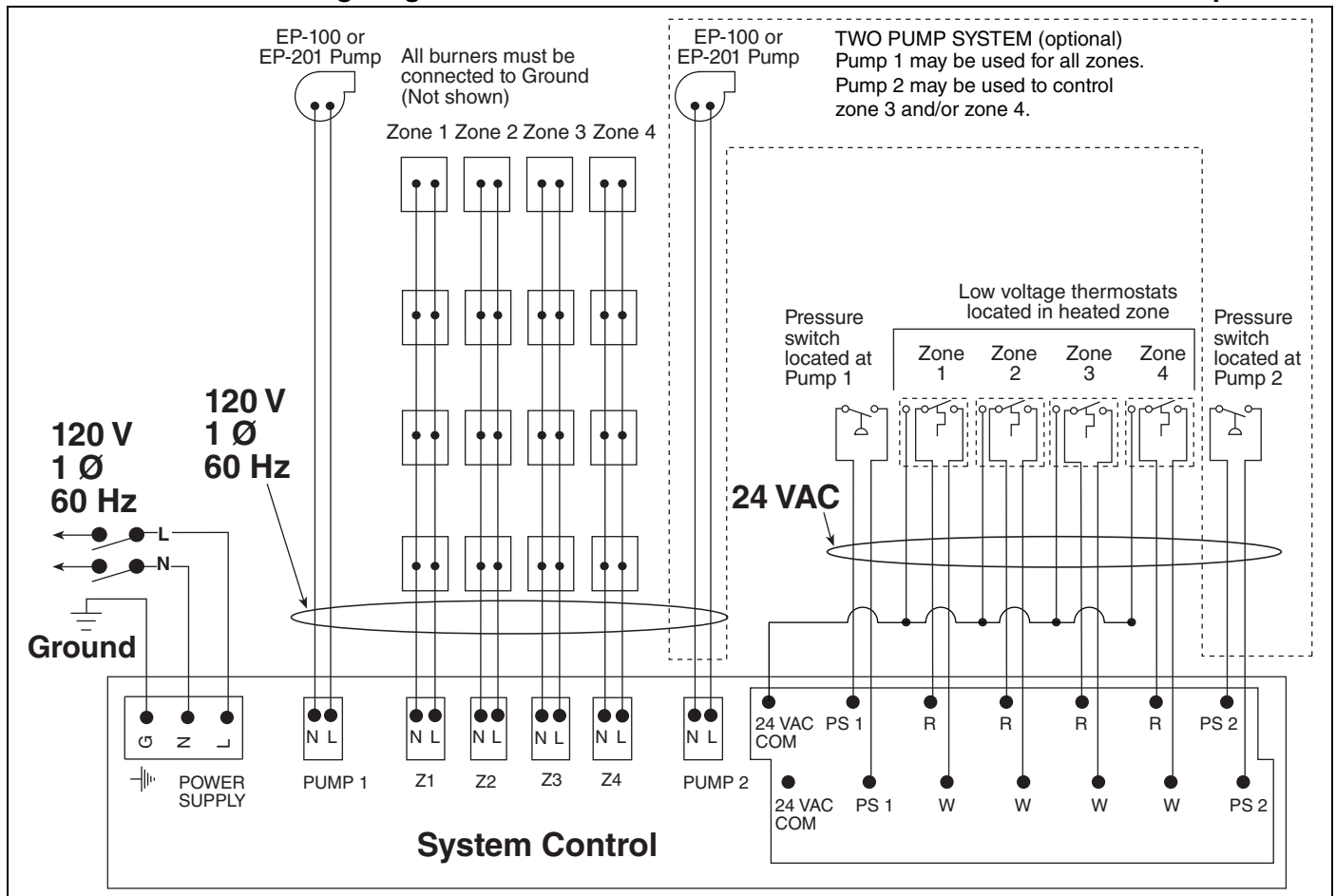

**FIGURE 6: External Wiring Diagram ROBERTS GORDON® EP-100, EP-201 or EP-301, 230 V 1 Ø Pump**

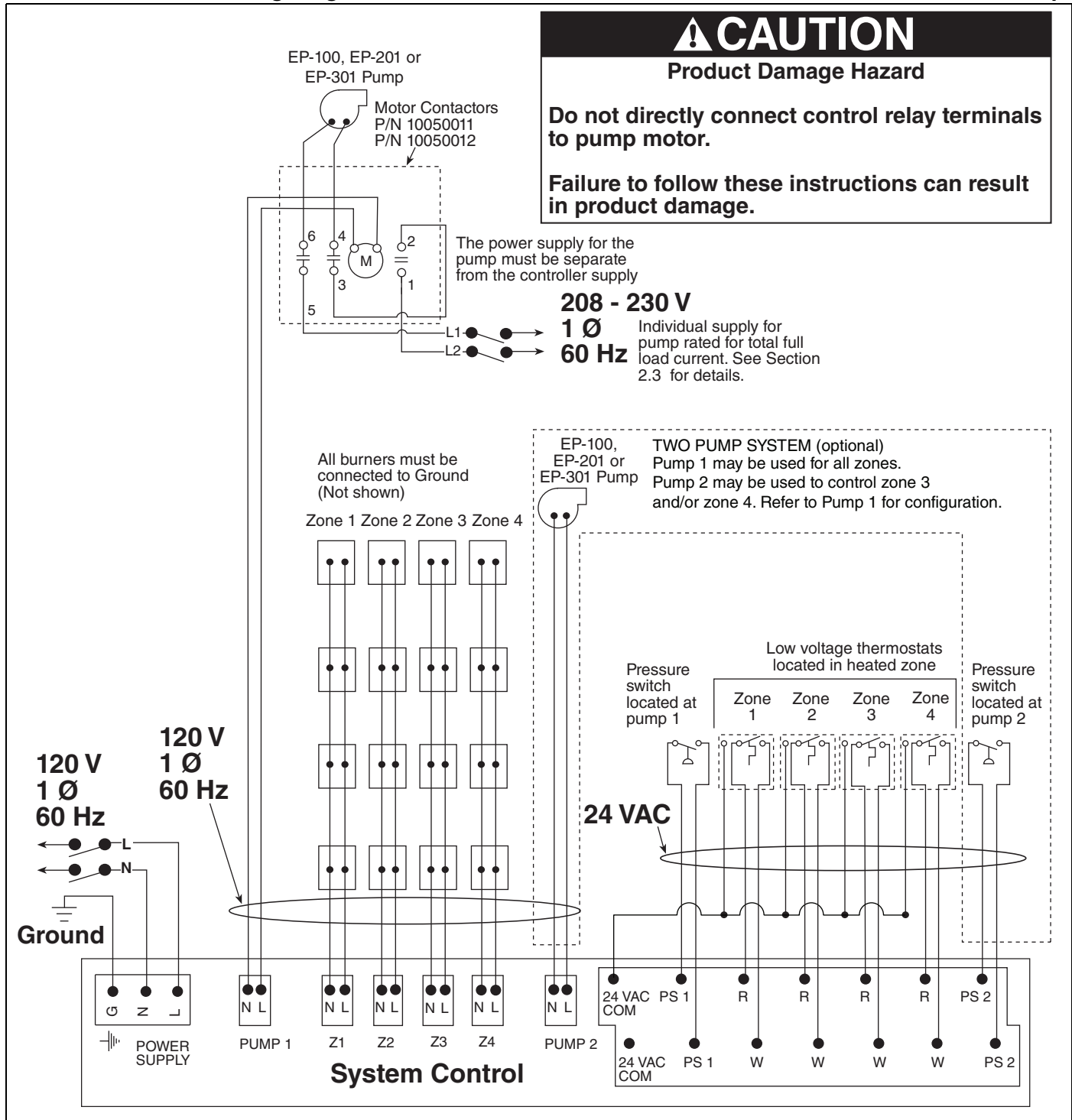

**4.2 EP-201 or EP-301 230 V 1 Ø External Wiring Diagram**

The external wiring diagram above shows the connections for four zones of system burners. System burners can be either CORAYVAC® or VAN-TAGE® NP (multiburner only).

The zones are connected to a single pump, unless zone 3 and/or zone 4 are selected to function with the optional pump 2. The external wiring diagram above shows connection to an EP 301 or EP-201 1 Ø

pump.

**4.2.1 External Wiring Connection Details**

The cable used for all the wiring must be rated for line voltage up to 600 Vac.

The low voltage circuit conforms with Class 2 separation of circuit requirements. National Electrical Codes® for wiring class 2 low voltage circuits must be followed.

**FIGURE 7: External Wiring Diagram ROBERTS GORDON® EP-203 or EP-303, 208 - 230 V (or 460 V) 3 Ø Pump**

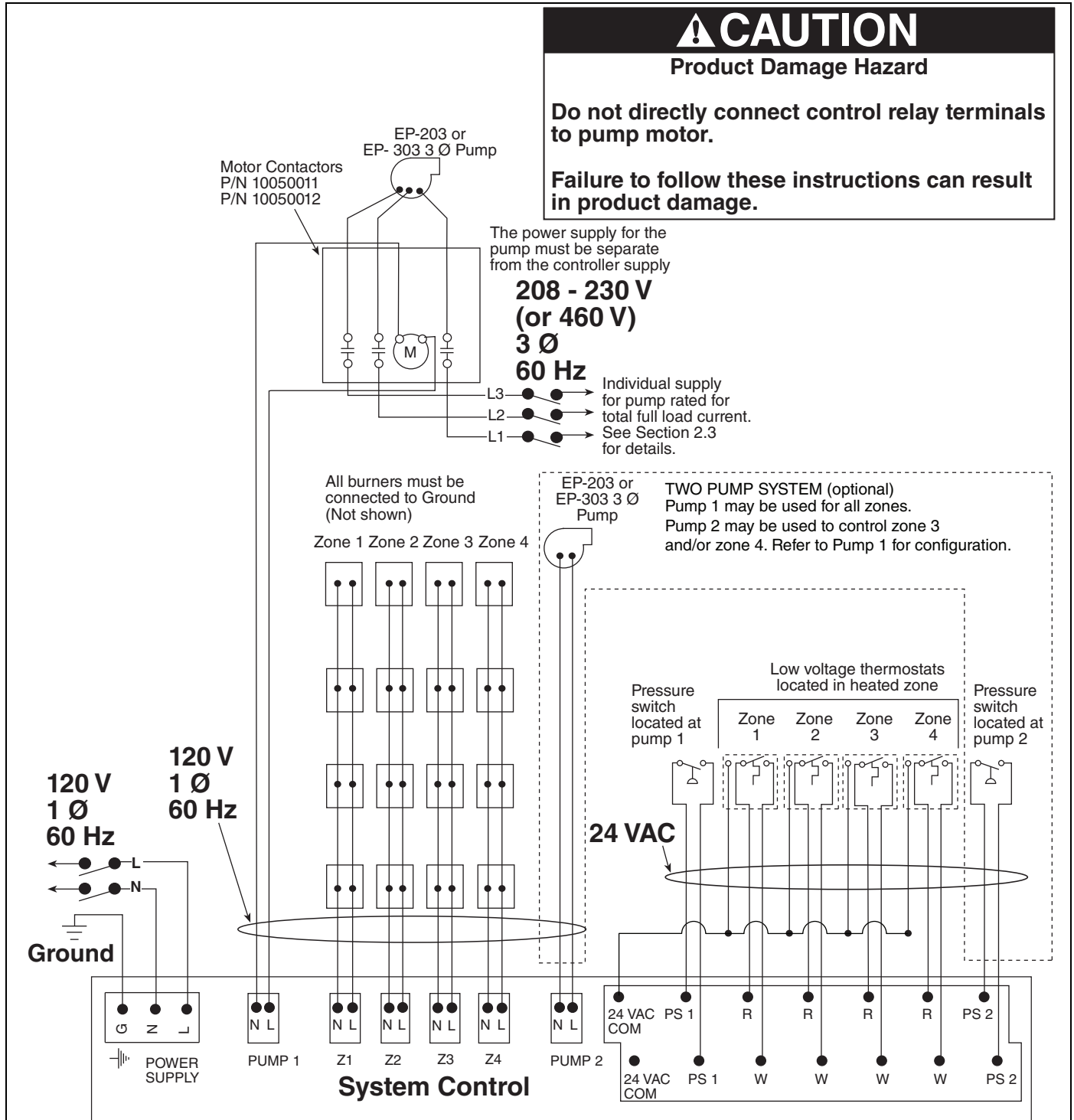

#### 4.3 EP-203 or EP-303 208 - 230 V (or 460 V) 3 Ø Pump External Wiring Diagram

The external wiring diagram above shows the connections for four zones of system burners. System burners can be either CORAYVAC® or VANTAGE® NP (multiburner only).

The zones are connected to a single pump, unless zone 3 and/or zone 4 are selected to function with the optional pump 2. The external wiring diagram

above shows connection to an EP-203 or EP-303 3 Ø pump.

##### 4.3.1 External Wiring Connection Details

The cable used for all the wiring must be rated for line voltage up to 600 Vac.

The low voltage circuit conforms with Class 2 separation of circuit requirements. National Electrical Codes® for wiring class 2 low voltage circuits must be followed.

**FIGURE 8: External Wiring Diagram ROBERTS GORDON® EP-100 or EP-201 120 V 1 Ø Pump with Outside Air Blower**

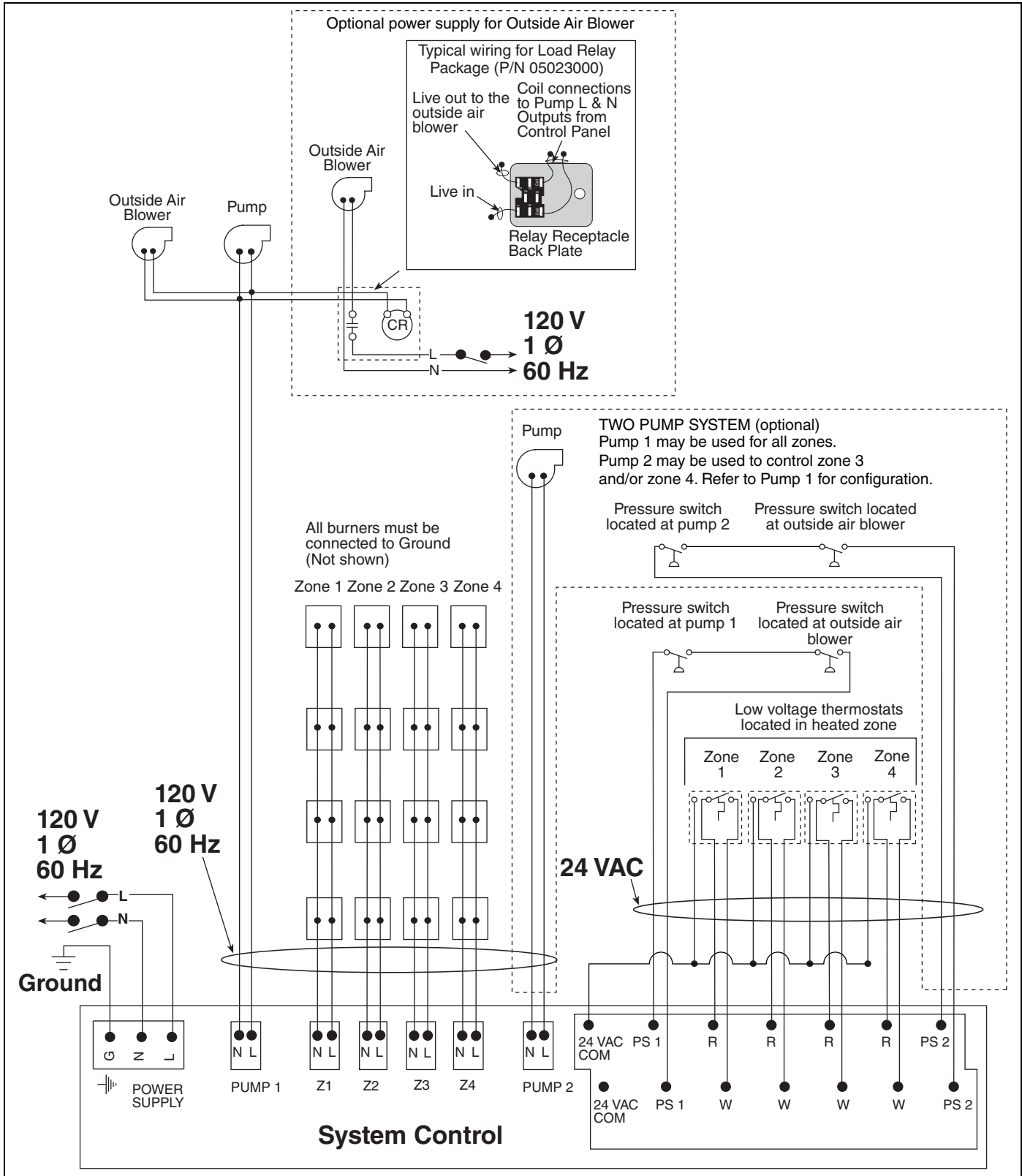

**4.4 Outside Air Blower External Wiring Diagram**

The external wiring diagram above shows the connections for four zones of system burners. System burners can be either CORAYVAC® or VANTAGE® NP (multiburner only).

The zones are connected to a single pump, unless zone 3 and/or zone 4 are selected to function with the optional pump 2. The external wiring diagram above shows connection to an EP-100 or EP-201 1 Ø motor. The diagram also shows the connection via a



load relay to the optional outside air blower.

#### **4.4.1 External Wiring Connection Details**

The cable used for all the wiring must be rated for line voltage up to 600 V.

The low voltage circuit conforms with Class 2 separation of circuit requirements. National Electrical Codes® for wiring class 2 low voltage circuits must be followed.

**SECTION 5: TROUBLESHOOTING**

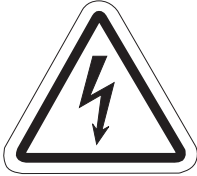
|  |
|--|
| <b>⚠ DANGER</b>  |
|   |
| <p style="text-align: center;"><b>Electrical Shock Hazard</b></p> <p><b>Disconnect electric before service or maintenance.</b></p> <p><b>More than one disconnect switch may be required to disconnect electric to the unit.</b></p> <p><b>Failure to follow these instructions can result in death or electrical shock.</b></p> |

|   |
|---|
| <b>⚠ WARNING</b>  |
|   |
| <p style="text-align: center;"><b>Explosion Hazard</b></p> <p><b>Turn off gas supply to equipment before service or maintenance.</b></p> <p><b>Failure to follow these instructions can result in death, injury or property damage.</b></p> |

tinuous operation, the system control will shut off and re-start to verify no faults exist in the system.

- e. After the heating is turned off, the pump will continue operation for 2 minutes, post purge.

**5.1 Sequence of Operation**



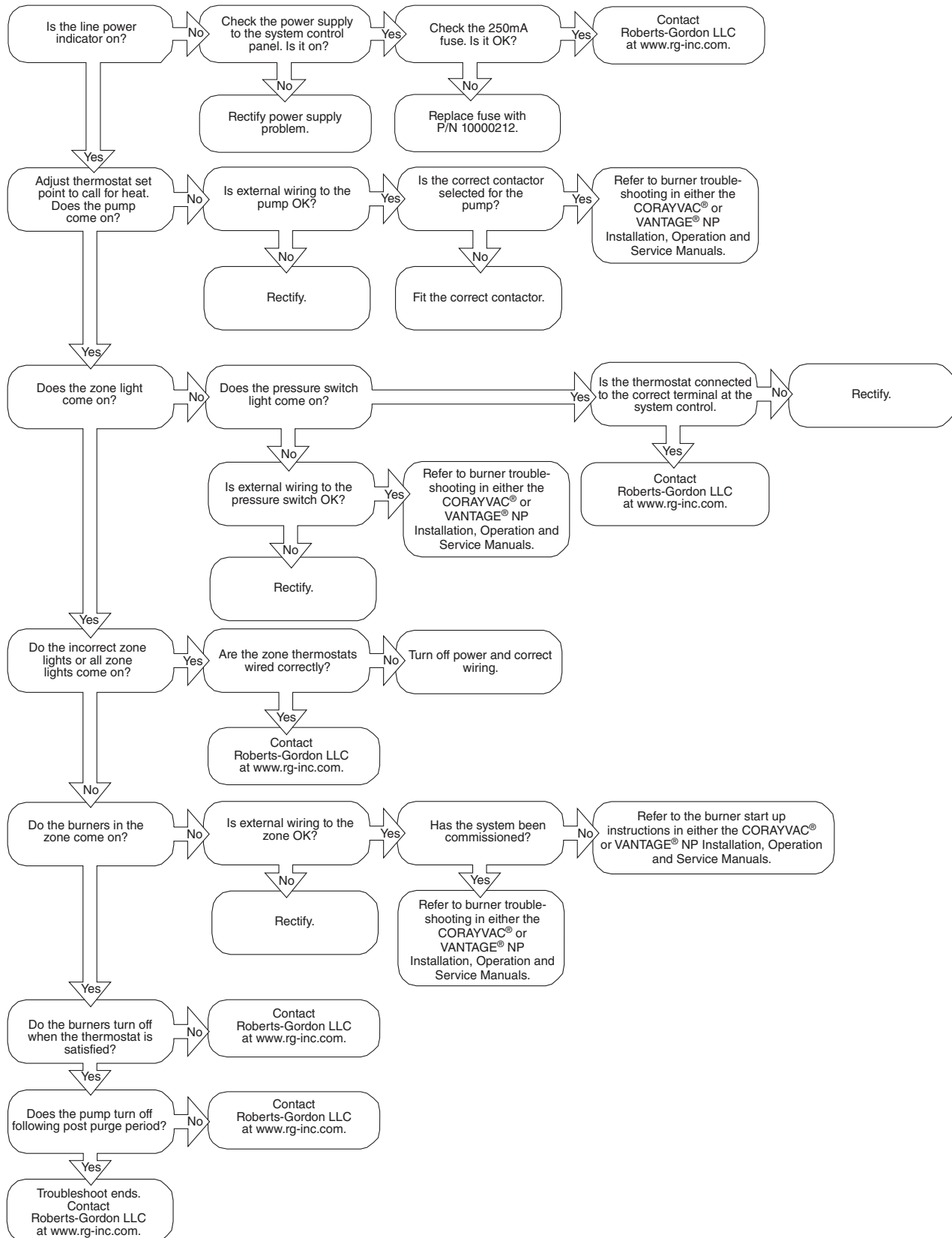

- a. On demand for heat from the thermostat, the panel will send power to the pump. The pump will begin operation.
- b. Once vacuum is established, the pressure switch at the pump will close. If the vacuum is not established within 30 seconds the pump will go into lockout (pump LED is flashing). After one hour of lockout, the system will re-start.
- c. The System Control panel sends power to the burners. The burners will go through a 45 second purge and cycle time.
- d. Once flame is established, the heater will remain in operation until such time as either the heating is turned off by the thermostat, lockout conditions occur, or after 24 hours of continuous operation. After 24 hours of con-

**FIGURE 9: System Control Troubleshooting Chart**

If control is not working properly, disconnect power to control and check for signs of physical damage to the front and back of the circuit board, water damage (corrosion) or scorching. If damage is found, identify and rectify source of damage. Replace circuit board (P/N 10090101), if it has permanent damage.

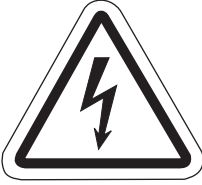

**SECTION 6: REPLACEMENT PARTS**

| <b>⚠ DANGER</b>  |   | <b>⚠ WARNING</b>   |   |
|--|---|--|---|
|   |  |  |  |
| <b>Electrical Shock Hazard</b>   | <b>Explosion Hazard</b>   | <b>Fire Hazard</b>   | <b>Carbon Monoxide Hazard</b>   |
| <p><b>Use only genuine ROBERTS GORDON® replacement parts per this installation, operation and service manual.</b></p> <p><b>Failure to follow these instructions can result in death, electric shock, injury or property damage.</b></p> |   |  |   |

**FIGURE 10: System Control Internal Components Diagram**

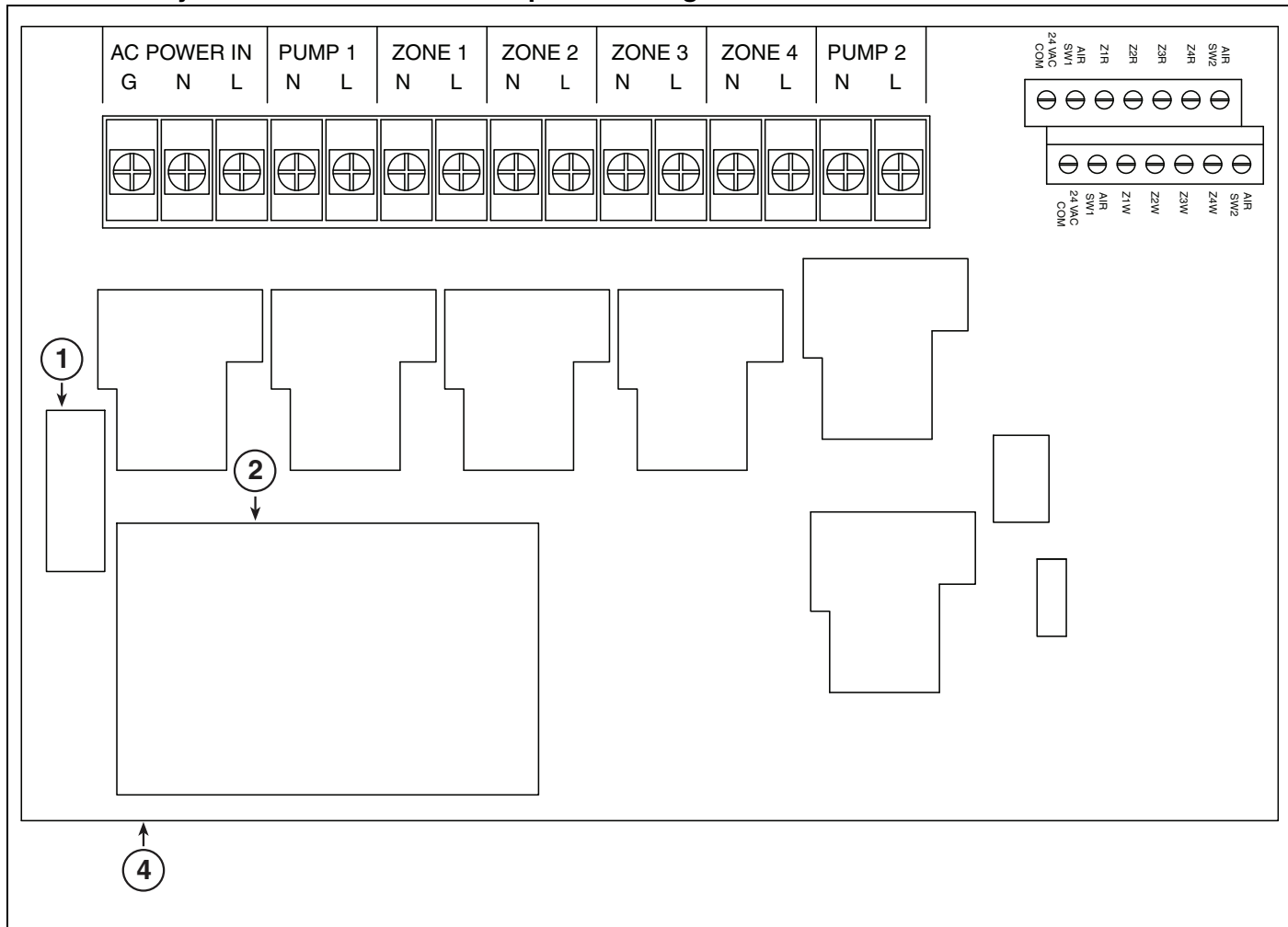

| Item | Description    | Part Number |
|------|----------------|-------------|
| 1    | Fuse 250 mA    | 10000212    |
| 2    | Transformer    | N/A         |
| 4    | Board Assembly | 10090101    |

## 6.1 Replacement Parts Instructions

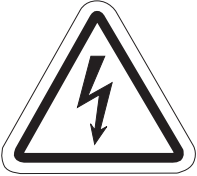
|  |
|--|
| <b>⚠ DANGER</b>  |
|   |
| <p style="text-align: center;"><b>Electrical Shock Hazard</b></p> <p><b>Disconnect electric before service or maintenance.</b></p> <p><b>More than one disconnect switch may be required to disconnect electric to the unit.</b></p> <p><b>Failure to follow these instructions can result in death or electrical shock.</b></p> |

See Page 14, Figure 10, Item 2.

### 6.1.3 Microprocessor Programming

The microprocessor may be re-programed by a reprogramming device.

Should the microprocessor program become suspect during troubleshooting, consult Roberts-Gordon LLC.

|   |
|---|
| <b>⚠ WARNING</b>  |
|   |
| <p style="text-align: center;"><b>Explosion Hazard</b></p> <p><b>Turn off gas supply to equipment before service or maintenance.</b></p> <p><b>Failure to follow these instructions can result in death, injury or property damage.</b></p> |

#### 6.1.1 Fuse 250 mA

See Page 14, Figure 10, Item 1.

This time delay fuse protects the System Control from power surges, lightning and incorrect wiring.

If the fuse needs replacing, the following steps must be taken.

Disconnect power to the System Control.

Remove the screws from the cover and remove the cover of the System Control. See Page 5, Section 3.2.2 for details.

Locate the fuse, and remove the fuse with a fuse pulling tool. See Page 14, Figure 10, Item 1.

Replace with a new fuse rated at 250 mA slow blow.

#### 6.1.2 Transformer

The transformer on the board cannot be replaced.



## SECTION 7: THE ROBERTS GORDON® SYSTEM CONTROL WARRANTY

### ROBERTS-GORDON LLC WILL PAY FOR:

Within 24 months from date of purchase by buyer or 27 months from date of shipment by Roberts-Gordon LLC (whichever occurs first), replacement parts will be provided free of charge for any part of the product which fails due to a manufacturing or material defect.

Roberts-Gordon LLC will require the part in question to be returned to the factory. Roberts-Gordon LLC will, at its sole discretion, repair or replace after determining the nature of the defect and disposition of part in question.

ROBERTS GORDON® Replacement Parts are warranted for a period of 12 months from date of shipment from Roberts-Gordon LLC or the remaining ROBERTS GORDON® System Control warranty.

### ROBERTS-GORDON WILL NOT PAY FOR:

Service trips, service calls and labor charges.

Shipment of replacement parts.

Claims where the total price of the goods have not been paid.

Damage due to:

- Improper installation, operation or maintenance.
- Misuse, abuse, neglect, or modification of the ROBERTS GORDON® System Control in any way.
- Use of the ROBERTS GORDON® System Control for other than its intended purpose.
- Incorrect gas or electrical supply, accident, fire, floods, acts of God, war, terrorism, or other casualty.
- Improper service, use of replacement parts or accessories not specified by Roberts-Gordon LLC.
- Failure to install or maintain the ROBERTS GORDON® System Control as directed in the Installation, Operation and Service Manual.
- Relocation of the ROBERTS GORDON® System Control after initial installation
- The use of the ROBERTS GORDON® System Control in a corrosive atmosphere containing contaminants.
- The use of the ROBERTS GORDON® System Control in the vicinity of a combustible or explosive material.
- Any defect in the ROBERTS GORDON® System Control arising from a drawing, design, or specification supplied by or on behalf of the consumer.
- Damage incurred during shipment. Claim must be filed with carrier.

### WARRANTY IS VOID IF:

The ROBERTS GORDON® System Control is not installed by an electrician qualified in the installation and service of control systems for heating equipment.

You cannot prove original purchase date and required annual maintenance history.

The data plate and/or serial number are removed, defaced, modified or altered in any way.

The ownership of the ROBERTS GORDON® System Control is moved or transferred. This warranty is nontransferable.

Roberts-Gordon LLC is not permitted to inspect the damaged controller and/or component parts.

### READ YOUR INSTALLATION, OPERATION AND SERVICE MANUAL.

If you have questions about your control, contact your installing professional. Should you need Replacement Parts or have additional questions, call or write:

#### Roberts-Gordon LLC

1250 William Street

P.O. Box 44

Buffalo, New York 14240-0044

716.852.4400

On the web at: [www.rg-inc.com](http://www.rg-inc.com)

**Roberts-Gordon LLC's liability, and your exclusive remedy, under this warranty or any implied warranty (including the implied warranties of merchantability and fitness for a particular purpose) is limited to providing replacement parts during the term of this warranty.** Some jurisdictions do not allow limitations on how long an implied warranty lasts, so this limitation may not apply to you. There are no rights, warranties or conditions, expressed or implied, statutory or otherwise, other than those contained in this warranty.

**Roberts-Gordon LLC shall in no event be responsible for incidental or consequential damages or incur liability for damages in excess of the amount paid by you for the ROBERTS GORDON® System Control.**

Some jurisdictions do not allow the exclusion or limitation of incidental or consequential damages, so this limitation or exclusion may not apply to you. This warranty gives you specific legal rights, and you may also have other rights which vary from jurisdiction to jurisdiction.

Roberts-Gordon LLC shall not be responsible for failure to perform under the terms of this warranty if caused by circumstances out of its control, including but not limited to war, fire, flood, strike, government or court orders, acts of God, terrorism, unavailability of supplies, parts or power. No person is authorized to assume for Roberts-Gordon LLC any other warranty, obligation or liability.

### LIMITATIONS ON AUTHORITY OF REPRESENTATIVES:

No representative of Roberts-Gordon LLC, other than an Executive Officer, has authority to change or extend these provisions. Changes or extensions shall be binding only if confirmed in writing by Roberts-Gordon LLC's duly authorized Executive Officer.

