

REMINGTON®

MICROFLEX® 200
MICROFLEX® 400



*Use and
Care Guide*

R-200
R-225
R-400 (shown)

IMPORTANT SAFETY INSTRUCTIONS

When using an electrical appliance, basic precautions should always be observed, including the following. Read all instructions before using this appliance.

DANGER

To reduce the risk of electric shock:

- Do not reach for an appliance that has fallen into water. Unplug it immediately.
- Do not use while bathing or in the shower.
- Do not place or drop into water or other liquid.
- Do not place or store this appliance where it can fall or be pulled into a tub or sink.
- Except when charging, always unplug this appliance from the electrical outlet immediately after using.
- Unplug this appliance before cleaning it.

WARNING

To reduce the risk of burns, fire, electric shock or injury to persons:

- This appliance is for household use only.
- An appliance should never be left unattended when it's plugged in, except when charging a rechargeable appliance.
- Close supervision is necessary when this appliance is used by, on, or near children or invalids.
- Use this appliance only for its intended use as described in this manual. Do not use attachments not recommended by Spectrum Brands, Inc.
- Keep the cord away from heated surfaces.
- Never operate this appliance if it has a damaged cord or plug, if it is not working properly, if it has been dropped or damaged, or if it has been dropped into water. If any of these things happen, return the appliance to an authorized service center for examination and repair.

- Never drop or insert any object into any of the appliance's openings.
- Do not use outdoors or operate where aerosol (spray) products are being used, or where oxygen is being administered.
- Always store this appliance and cord in a moisture-free area. Do not store it in temperatures exceeding 140°F (60°C).
- Do not plug or unplug this appliance when your hands are wet.
- Do not use an extension cord or a voltage converter with this appliance.
- Do not wrap the cord around the appliance.
- Always attach the plug to the appliance, then to the outlet. To disconnect, turn all controls to OFF, then remove plug from outlet. Detach removable power cords from appliances for storage.
- Do not use this appliance with a damaged or broken head or cutters, as facial injury may occur.
- Shavers, including the trimmer, are for use on facial hair only. Should not be used for shaving the hair on your head or any other part of your body.

SAVE THESE INSTRUCTIONS

Contents

English.....1
 Spanish.....13
 French.....25

Product Features

Shaver Parts

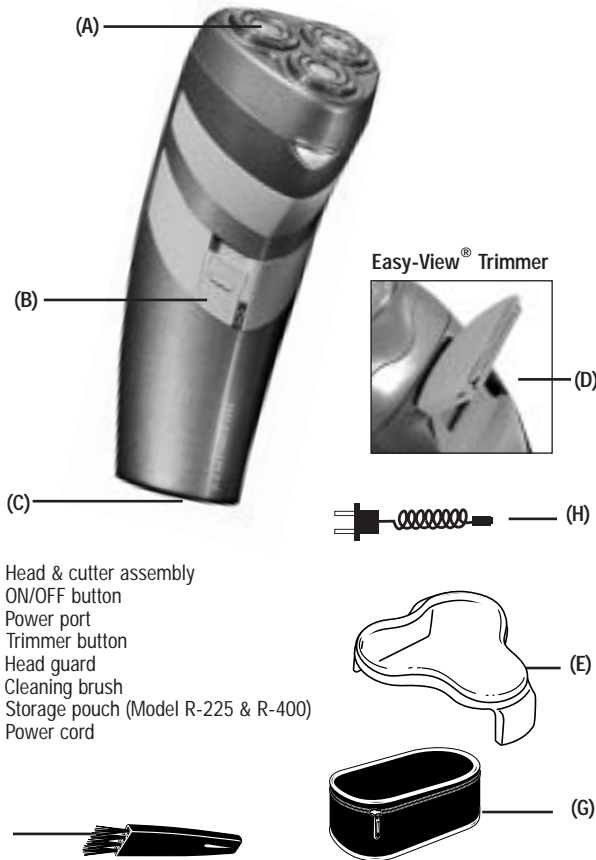

- (A) Head & cutter assembly
- (B) ON/OFF button
- (C) Power port
- (D) Trimmer button
- (E) Head guard
- (F) Cleaning brush
- (G) Storage pouch (Model R-225 & R-400)
- (H) Power cord

Congratulations on your purchase of a premium Remington® shaver, with revolutionary shaving technology

Which model is yours?

	Pouch	Corded Operation	Cordless Operation	Run Time	Charge Time	Locking Trimmer
R-200		X				
R-225	X	X				
R-400	X		X	30 min.	16 hrs.	X

Power System

- Corded (R-200 & R-225) shavers can only be used with the power cord.
- Cordless (R-400) shavers can only be used without the power cord.

Indicator Lights (R-400 only)

Charging

- The charging indicator is a green light that glows when the shaver is being charged.

How to Use

Before using read the important safety instruction section in front of the manual.

Removing the Headguard

Before operating your shaver, remove the headguard, which protects the head and cutter assembly. It is important to remove the headguard correctly to avoid damaging the clips that hold it to the shaver.

1. Press lightly on the top of the head guard.
2. Lift the lower rear edge.
3. Pull the headguard away from the shaver.

! Always keep the protective head guard on the shaver head and keep the trimmer in the OFF position when the shaver is not in use.

Corded Operation of the R-200 and R-225

- Slide the power button down to the OFF position.
- Connect the supplied AC power cord to the shaver's power port and then to an electrical outlet.
- To activate the shaver, slide the power button up to the ON position.

Charging the R-400

Before using your shaver for the first time, charge it for 24 hours.

NOTE: It may take up to 3 cycles of full charge and discharge to maximize battery capacity.

To charge your shaver

- Slide the power button downward to the OFF position.
- Connect the supplied AC power cord to the shaver's power port and then to an electrical outlet.

6

- Your shaver cannot be overcharged, so you can leave it plugged in and charging between shaves.
- To preserve the life of the batteries, allow them to fully discharge every six months, then recharge them for 24 hours.

Rechargeable shavers like the R-400 are designed for cordless operation only. Plugging it in will not provide the power to shave.

Cordless Operation of the R-400

- Remove the AC power cord from the electrical outlet, then remove from shaver's power port.
- To activate the shaver, slide the power button up to the ON position.

Operating the Easy-View® Trimmer

The Easy-View® pop-up trimmer extends to trim mustache, sideburns, etc.

- Trimmer is turned off until it is extended for use.
- Push the trimmer button up to pop up the trimmer.
- Hold the shaver with the trimmer toward you when trimming.
- After trimming, pull the trimmer button downward into the OFF position. Leave it in the down position when not in use.

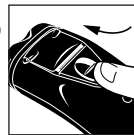

NOTE (R-400): It is important to always use the button to close the trimmer to avoid damaging the locking mechanism.

Usage Tips

Getting a close, comfortable shave

Remington shavers need no adjustments to their heads or cutters before you shave. The heads will automatically adjust to the contours of your face.

Adjusting to your new shaver

As with every shaver, your shave will improve over time. So allow about three weeks to develop an effective shaving style and for your beard to adjust to the new shaver. The adaptation period may take a little longer if your skin is sensitive, or if you alternate between shaving methods.

Before you begin:

- Wait at least 15 minutes after getting up before shaving to ensure the face is free of puffiness that may be present from sleeping.
- Make sure your face is clean and dry before starting.
- Always use a clean, dry shaver.
- Make sure the cutter head assembly is in the locked position.

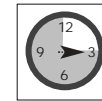

To Shave

- Slide the ON/OFF button to activate the shaver for shaving.
- Hold the shaver so all the heads touch your face together. This allows the shaver to work the way it was designed for the closest

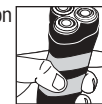

shave and minimum wear. Avoid holding the shaver at an angle so only one head touches the skin. This could cause skin irritation.

- Use short, circular strokes. Use your free hand to stretch your skin. This encourages your whiskers to stand out, making it easier for them to enter the cutting chamber.
- It is not necessary to apply pressure while shaving, just let the shaver glide lightly on your skin. Never press hard. Pressing only flattens your whiskers, which makes it harder for them to enter the cutting chamber. It will also wear out the cutting surface more quickly. A gentle touch makes shaving easier and helps avoid possible skin irritation.



To Trim

Trim mustache

- Use the shaver heads to trim the lower edge of your mustache. Hold shaver at desired trim line for a quick, easy, professional trim.
- Use the pop-up trimmer for the upper edge of your mustache. Extend the trimmer and touch the edge of it to the desired line.



Trim sideburns

Extend the trimmer and touch the edge of it to the desired trim line.



7

Cleaning and Maintenance

To assure smooth, efficient performance, it is important to clean your shaver.

Daily

Brush inside the head assembly after each use:

1. Turn the shaver off.
2. Grip the head assembly by the three ridges and pull it off the shaver.
3. Use the cleaning brush to sweep out the internal part of the head assembly and the hair pocket area, where 3 shaver spindles are located.

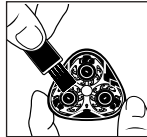
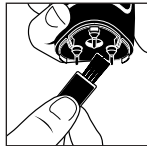
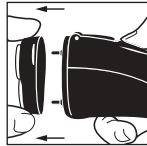

4. Replace head assembly.

Weekly

Clean under the cutter assembly at least once a week:

1. Turn the shaver off.
2. Open the head assembly as above.
3. Unscrew the center screw knob to remove the cutter retainer assembly.
4. Use the cleaning brush to sweep the dust and hairs from under the cutters.
5. Replace head assembly.

Lubricate

Remington® Shaver Saver® Lubricant (SP-4) lubricates and cleans your shaver's cutters and head assembly. The lubricant helps remove hair clippings while reducing wear. A quick spray after each shave keeps your shaver operating at peak performance.

! Important: Make sure to align the two locating holes in the Cutter Retainer assembly with the pins in the Head Frame Assembly. (See illustration below). Then tighten center screw knob to lock the cutters into place.

Replace head assembly on the shaver simply by pushing it onto the shaver.

Cover shaver head with plastic head-guard between uses. When removing the headguard or placing it back onto the shaver, do not apply pressure to floating cutter surfaces, as you may damage them.

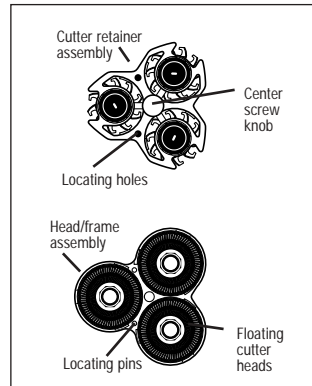

Cleaning Cautions

Cleaning Cautions

- The construction of this shaver is for dry operation only. It is not waterproof. Never put the shaver partially or completely into water.
- Never clean the shaver or replace the cutters while it is plugged into an electrical outlet.
- Do not use an aggressive cleansing agent as this may destroy the shaver coatings.
- Do not clean or remove the head assembly while the shaver is running or plugged in, as it may cause damage to the unit's heads or cutters.
- Replace worn or damaged parts with Remington® replacement parts only.

When is it Time to Replace Your Heads and Cutters?

It is very important to replace your heads and cutters when necessary to ensure a close, comfortable shave without irritation. We recommend they be replaced every 12 months. Here are some signs of head and cutter wear, indicating that replacement is needed.

Irritation

As the heads get excessively worn you may experience some skin irritation. This would be especially noticeable when you apply after-shave lotion.

Pulling

When the cutters wear you may feel a sense of pulling and a loss of closeness when you shave. This is an indication that it is time to replace your heads and cutters.

The replacement parts for your shaver is model SP-25.

U.S. residents: To order, contact us at 800-231-8793, visit us at www.remington-products.com or visit your local retailer.

Canadian residents: For any shaver accessory requirements, please call 800-268-0425 or visit us at www.remington-products.com

Battery Disposal

Battery Removal (R-400 only)

When your rechargeable shaver reaches the end of its useful life, the batteries must be removed from the shaver and be recycled or disposed of properly in accordance with your local and state requirements.

The following procedures should be followed for battery removal:

- Make sure your shaver is unplugged from any outlets, so you don't risk an electrical shock.
- Remove the Head Assembly by gently lifting the assembly away from the shaver.
- Using a small Phillips head screwdriver, remove the screws from the upper and lower back of the shaver.
- Pull or gently pry the shaver halves apart, exposing the battery.
- Hold each battery in place and very carefully cut the wires leading to the terminals on each battery.
- Lift or pry the battery out of the shaver.



CAUTION: DO NOT PUT IN FIRE OR MUTILATE YOUR BATTERIES WHEN DISPOSING AS THEY MAY BURST OR RELEASE TOXIC MATERIALS. DO NOT SHORT CIRCUIT AS IT MAY CAUSE BURNS. DISPOSE PROPERLY IN ACCORDANCE WITH YOUR LOCAL AND STATE REQUIREMENTS.

The EPA-certified RBRC® Battery Recycling Seal on the nickel-cadmium (Ni-Cd) battery indicates Spectrum Brands, Inc. is voluntarily participating in an industry program to collect and recycle these batteries at the end of their useful life, when taken out of service in the United States or Canada. The RBRC® program provides a convenient alternative to placing used Ni-Cd batteries into the trash or the municipal waste stream, which may be illegal in your area. Please call 800-8-BATTERYSM for information on Ni-Cd battery recycling and disposal bans/restriction in your area. Spectrum Brands, Inc. involvement in this program is part of our commitment to preserving our environment and conserving our natural resources.



Performance Guarantee

Full Two-Year Warranty

Spectrum Brands, Inc. warrants this product against any defects that are due to faulty material or workmanship for a two-year period from the original date of consumer purchase. This warranty does not include damage to the product resulting from accident or misuse. If the product should become defective within the warranty period, we will repair it or elect to replace it free of charge. Return your product and sales receipt with your name, address and day time phone number to: Spectrum Brands, Inc., Attention: Consumer Services, 601 Rayovac Drive, Madison, WI 53711. For more information call 800-736-4648.

Warranty excludes:

- Screens and cutters

KEEP ORIGINAL SALES RECEIPT AS PROOF OF PURCHASE FOR WARRANTY PURPOSES.

This warranty does not cover products damaged by the following:

- Accident, misuse, abuse or alteration of the product
- Servicing by unauthorized persons
- Use with unauthorized accessories
- Connecting it to incorrect current and voltage
- Wrapping cord around appliance causing premature wear & breakage
- Any other conditions beyond our control

SPECTRUM BRANDS, INC. SHALL NOT BE RESPONSIBLE FOR ANY INCIDENTAL, SPECIAL OR CONSEQUENTIAL DAMAGES RESULTING FROM THE USE OF THIS PRODUCT. ALL IMPLIED WARRANTIES, INCLUDING BUT NOT LIMITED TO IMPLIED WARRANTIES OF FITNESS AND MERCHANTABILITY, ARE LIMITED IN DURATION TO TWO YEARS FROM DATE OF ORIGINAL PURCHASE.

This warranty gives you specific legal rights and you may also have other rights which vary from state to state or province to province. Some states do not allow the exclusion or limitation of incidental, special or consequential damages.

Performance Guarantee Spectrum Brands, Inc. Money-back Offer

If within 30 days after you have purchased your Remington® branded product, you are not satisfied and would like a refund, return it with the sales slip indicating purchase price and date of purchase to the retailer from whom it was purchased. Spectrum Brands, Inc. will reimburse all retailers who accept the product within 30 days from the date of purchase. If you have any questions concerning the money-back guarantee, please call 800-736-4648.

Warranty Service

R-200, R-225
120 VAC, 60 Hz

Dist. by: Spectrum Brands, Inc.,
Madison, WI 53711

R-400
105-130 VAC, 60 Hz
105-240 VAC, 50 Hz

Dist. by: Rayovac Canada Inc.,
Mississauga, ON L4W 2T7

MADE IN CHINA

Questions or comments:
Call 800-736-4648 in U.S. or
800-268-0425 in Canada.
Or visit www.remington-products.com



REMINGTON & MICROFLEX and
EASY-VIEW are trademarks of
ROVCAL, INC.
© 2006 ROVCAL, INC.
1/06 Job #CS29563

T22-20903