

PYRAMAT®

S1000 SOUND ROCKER™



OWNER'S MANUAL

**Read and understand this entire manual before using!
For assistance contact Pyramat. DO NOT RETURN TO STORE.**

Item Number:
10175440

Congratulations on the purchase of your Pyramat S1000 Sound Rocker. The Sound Rocker is a comfortable, rockable chair that delivers a powerful audio experience designed to intensify your enjoyment of games, movies, music and more. To ensure the best results, please read this manual completely before operating your Sound Rocker, and retain it for future reference.

CONTENTS

Safety Warnings	1
Before You Begin.....	2
Features.....	2
Set-Up.....	3
Connection Methods.....	3 - 4
Troubleshooting Guide.....	5
Warranty	6

SAFETY WARNINGS

⚠ WARNING: The Pyramat Sound Rocker is intended for indoor use only. TO REDUCE THE RISK OF FIRE OR SHOCK HAZARD, DO NOT EXPOSE THIS PRODUCT TO RAIN OR MOISTURE.

- Do not expose to direct sunlight or extreme temperatures.
- Adult supervision is required for set-up.
- Use only with the supplied power adapter. The power adapter is not a toy.
- Excessive use of audio equipment at high volume may lead to hearing loss. Listen responsibly and use common sense.
- Children under 13 should not use this product without parental supervision.
- DO NOT wash or soak the Sound Rocker with water. If cover becomes wet, disconnect power immediately and don't use until totally dry.
- To avoid injury or death from electrical shock, NEVER open the electrical cabinet or remove the cover.

The Sound Rocker is compatible with:

- All gaming consoles (including Xbox 360 and Playstation 3)
- MP3 players
- TVs, DVDs, VCRs
- Portable gaming devices

Need Help? Visit our website at **www.pyramat.com**, send an e-mail to **service@pyramat.com** or call toll-free at **877-591-1012**.

BEFORE YOU BEGIN

Remove the foam separators from the Sound Rocker and take unit out of box. Check to make sure you have all the parts shown below and that all items are in good condition.

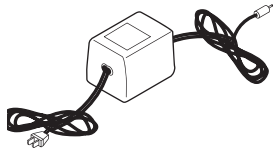

11 ft. 12-volt AC power adapter



11 ft. red and white RCA audio cable



2.5 mm mini plug adapter



3.5 mm mini plug to RCA plug adapter



(2) RCA audio cable extenders

CAUTION: Keep fingers clear of the folding seam when opening the unit.

Note: Replacement cables and mini adapters can be purchased at your local audio accessory dealer.

FEATURES

ARX speakers

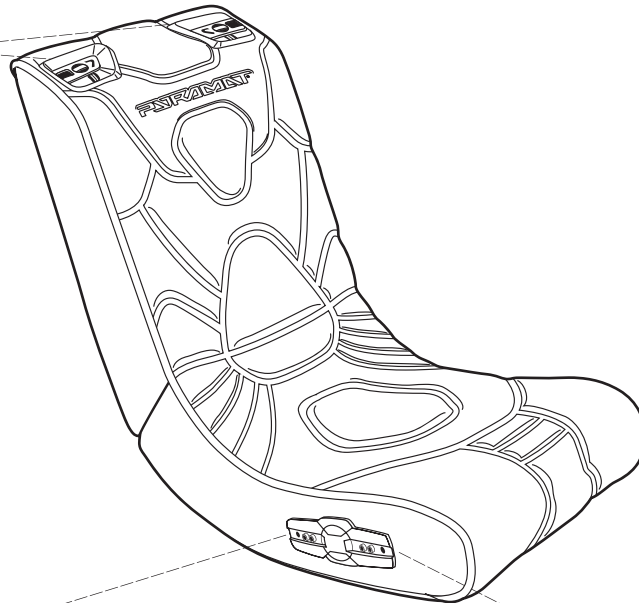

Control Panel

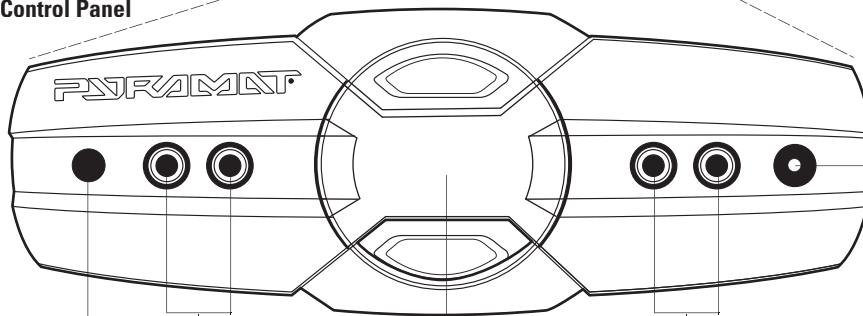

Headphone port

Connect headphones here.

Multi-player RCA audio output ports

Connect up to four Sound Rockers together for multi-user fun.

Volume/power knob

Twist to click on and power up and adjust the volume level.

Input RCA audio ports

Connect red and white RCA audio cable here from game consoles, home theater, satellite receiver and stereo receiver.

Power AC port

Connect supplied 12-volt power adapter here.

SET-UP

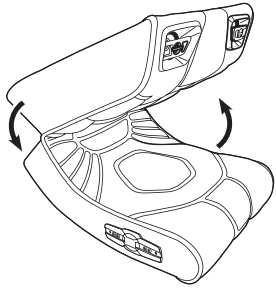

1 Unfold the top portion of the Sound Rocker until the backrest is flush with the seat portion.

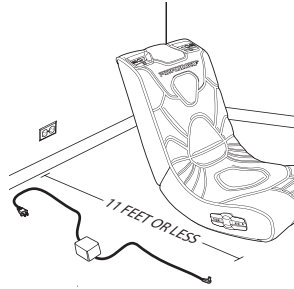

2 Place the Sound Rocker so that the control panel is less than 11 ft./3.5 meters from the power source.

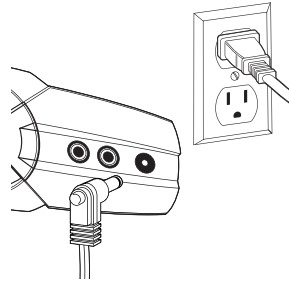

3 Connect the 12-volt AC power adapter to the electrical outlet and then to the power AC port on the control panel.

CAUTION: Keep fingers clear of the folding seam when folding or unfolding the rocker.

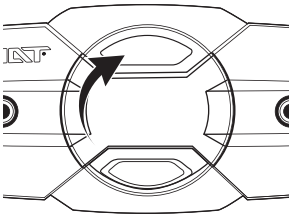

4 Twist the volume knob to click on the power.

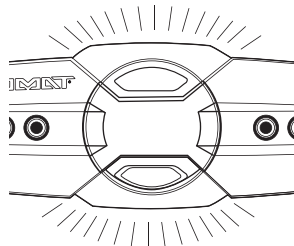

5 Check the control panel to see if it is lit up. Twist volume knob to power off the Sound Rocker, then proceed to the connection method shown below for your audio/video device.

CONNECTION METHODS

Video Game Console Connection

XBOX 360™, PLAYSTATION 2™, PLAYSTATION 3™, GAMECUBE™ and others

There are four types of audio/video cables that come with video game consoles:

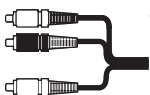

1. Standard AV/RCA Cable
(red, white–audio; yellow–video)

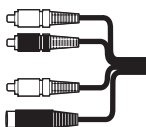

2. S-Video AV/RCA Cable
(red, white–audio; yellow, black–S-video)

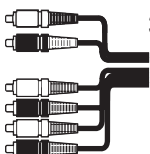

3. High Definition AV/RCA Cable
(red, white–audio; yellow, blue, red, green–video)

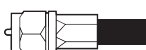

4. Coaxial Connection
(single black cable)

If you have this cable, you need to purchase the RCA audio cable from the console manufacturer. Or, you can connect the Pyramat through an intermediary audio source such as a TV, DVD, VCR, etc. (see below).

CONNECTION METHODS

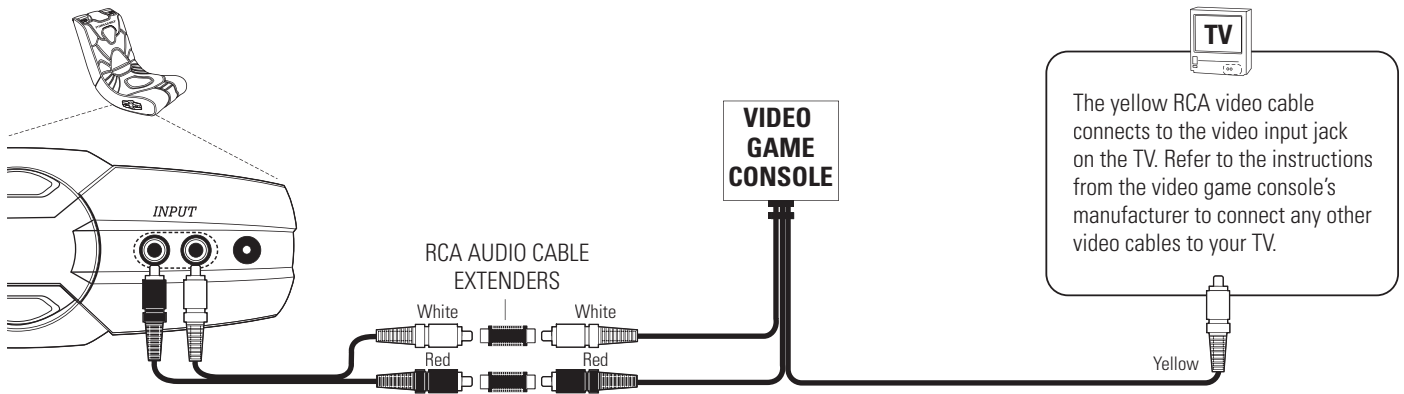

RCA Audio Cable Connection

For standard AV/RCA Cable, S-Video AV/RCA Cable and High Definition AV/RCA Cable

Connect the RCA audio cable extenders to the red and white audio cables from the video game console. Connect the supplied RCA audio cable to the video game console's red and white audio cables and plug into the input jacks on the Sound Rocker. Follow the instructions from the video game console's manufacturer to connect the video cable to your television.

OR

Coaxial Cable Connection

If your video game console has a coaxial cable instead of an RCA audio cable, then use the instructions provided by the video game console's manufacturer to hook up the video game console through an intermediary device (such as a TV, DVD, VCR, satellite receiver, etc.). Your intermediary device must have both a coaxial input jack (the standard jack for cable TV) and an RCA audio output jack, or you can purchase an RCA replacement cable directly from the console manufacturer. Then follow the audio/video device connection instructions to connect your Sound Rocker.

Audio/Video Device Connection

TV, DVD PLAYER, VCR, SATELLITE RECEIVER, STEREO

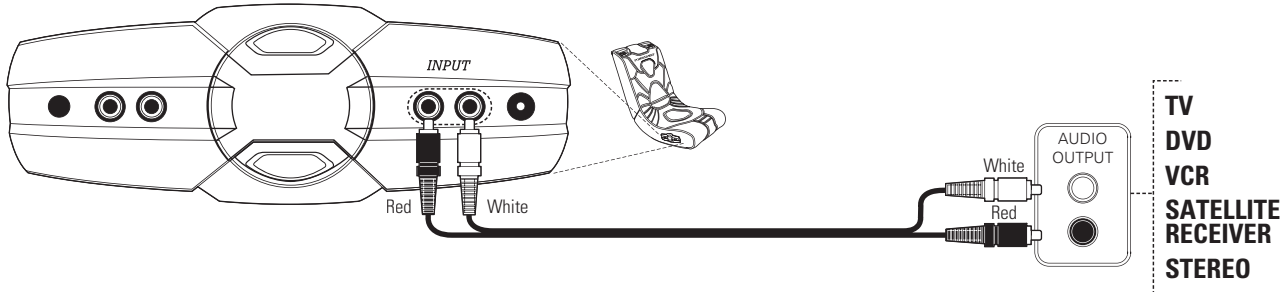

Connect the supplied RCA audio cable from the red and white input jacks on the Sound Rocker to the red and white audio output connection on your audio/video device.

Note: Connection must be made to an AUDIO OUTPUT source. The red and white audio connections on the front of most devices are AUDIO INPUT. SOUND WILL NOT PLAY FROM AN AUDIO INPUT SOURCE.

Multi-User Connection

CONNECT UP TO FOUR SOUND ROCKERS TOGETHER FOR MULTI-USER FUN!

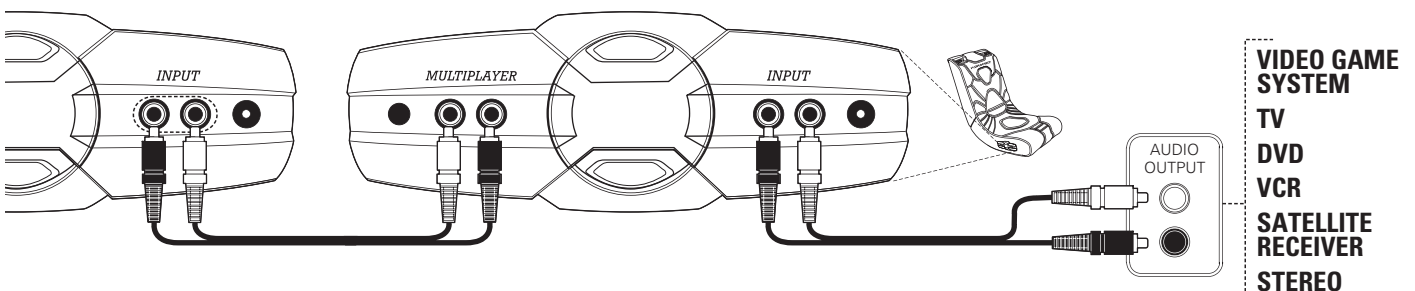

After connecting one Sound Roker to an audio/video device, you can connect additional Sound Rokers together. Connect the supplied RCA audio cable to the multi-player connection on the first Sound Roker and then to the input connection on the second Sound Roker. Repeat to add more Sound Rokers.

TROUBLESHOOTING GUIDE

Problem	Possible Cause	Solution
Unable to hear sound	The RCA audio cables are not connected properly.	Check the connection on your audio/video device. The RCA cables should be connected to the AUDIO OUTPUT jacks. Check the connection on your rocker. The RCA cables (red and white) must be in the AUDIO INPUT ports.
	The AC power adapter is disconnected from the electrical outlet or the electrical outlet has no power.	Check the plug on the AC power adapter. When properly connected with the volume knob on, the control panel will illuminate. If the Sound Rocker still doesn't power up, try another electrical outlet.
Unable to connect to the gaming console	Cables are incorrectly connected.	Check that the console's RCA audio cables are connected to the Sound Rocker's RCA audio cables (red to red and white to white). Check that the Sound Rocker RCA audio cables (red and white) are connected to the AUDIO INPUT jacks on the rocker. Check that the console's RCA video cable (usually yellow) is connected to the VIDEO INPUT jack on the TV. If your video game console has an RCA audio cable, then connect the RCA audio cable extenders to the red and white audio cables from the video game console. Connect the supplied RCA audio cable to the video game console's red and white audio cables and plug into the input jacks on the Sound Rocker.
	Your video game console has a coaxial cable instead of an RCA audio cable	Use the instructions provided by the video game console's manufacturer to hook up the video game console to an intermediary device (such as a TV, DVD, VCR, satellite receiver, etc.). Your intermediary device must have both a coaxial input jack (the standard jack for cable TV) and an RCA audio output jack. Purchase an RCA replacement cable directly from the console manufacturer.
Sound only plays from one speaker.	RCA cables are incorrectly connected.	Check that all RCA audio connections are correct – red to red, white to white
	Audio/video device has a single MONO audio output (a common problem when connecting to an older TV or VCR).	If your audio source is mono only, as found mainly on older model TVs and VCRs, an RCA "Y" adaptor (1 male to 2 male; not included) is needed to send the signal to both Pyramat speakers. Please note: the use of this type of adaptor will not produce a true stereo sound. For optimal performance, it is recommended that you connect your Pyramat product to stereo outputs only.
No sound will play from the Sound Rocker.	RCA audio cables are incorrectly connected.	RCA audio cables (red and white) must be plugged in to AUDIO OUTPUT jacks in the source device (TV, VCR, etc.). If you are plugging the cables to the jacks in the front of your TV these are most likely AUDIO INPUT jacks.
Missing or broken cables or mini adapters.		Replace items immediately. Replacement cables and mini adapters can be purchased at your local audio accessory dealer.
Missing or broken power adapter.		Replace immediately with an authorized Pyramat power adaptor. Do not use the unit until the damaged power adapter has been replaced.

Need Help? Visit our website at www.pyramat.com, send an e-mail to service@pyramat.com or call toll-free at **877-591-1012**.

S1000 Sound Rocker Limited Warranty

Pyramat warrants this product and any included accessories against defects in material and workmanship for a period of 90 days from the date of first consumer purchase. This warranty is enforceable only by the original purchaser. ALL DAMAGED OR MISSING PARTS MUST BE REPORTED WITHIN 14 DAYS OF PURCHASE.

This warranty covers all defects in materials and workmanship, but DOES NOT COVER the following:

1. Damage, deterioration or malfunction resulting from:

a. Acts of God, accident, misuse, abuse, negligence, improper installation, maintenance or operation, or failure to follow the instructions contained in this manual.

b. Any shipment of the product (claims must be presented to the carrier).

c. Repair, attempted repair or modification by anyone other than the Pyramat Service Center.

2. Any unit which has been altered or on which the serial number has been defaced, modified or removed.

3. Any unit used for industrial or commercial purposes.

4. Products sold AS IS or WITH ALL FAULTS, or consumables (such as fuses or batteries).

5. Customer installation, set-up, adjustments or signal reception problems.

Pyramat will repair or replace (at its discretion) units covered by this warranty, without charge to the consumer for labor or materials. CONSUMER IS RESPONSIBLE FOR ANY INSTALLATION OR REMOVAL CHARGES AND ANY INITIAL SHIPPING CHARGES. However, we will pay the return shipping charges to any destination within the United States if repairs are covered by the warranty.

REPAIR OR REPLACEMENT AS PROVIDED UNDER THIS WARRANTY IS THE EXCLUSIVE REMEDY OF THE CONSUMER. PYRAMAT SHALL NOT BE LIABLE FOR ANY INCIDENTAL OR CONSEQUENTIAL DAMAGES FOR BREACH OF ANY EXPRESS OR IMPLIED WARRANTY ON THIS PRODUCT. EXCEPT TO THE EXTENT PROHIBITED BY APPLICABLE LAW, ANY IMPLIED WARRANTIES, INCLUDING WARRANTIES OF MERCHANTABILITY AND FITNESS FOR A PARTICULAR PURPOSE, ARE LIMITED IN DURATION TO THE LENGTH OF THIS WARRANTY.

Some states do not allow the exclusion or limitation of incidental or consequential damages, or allow limitations on how long an implied warranty lasts, so the above limitations may not apply to you.

TO OBTAIN WARRANTY SERVICE

For service assistance, product information, or to locate the dealer nearest you, please call or write:

Pyramat Service Center
877-591-1012
service@pyramat.com

For further information on how to order accessories for this product or other Pyramat products, please visit our website at **www.pyramat.com**.

IMPORTANT

For your records, save your original sales receipt with this manual and write the serial number here.



**If you have problems with your Sound Rocker,
DO NOT RETURN TO STORE.**

**Follow instructions in this manual.
Failure to follow these instructions may damage
your Sound Rocker and void your warranty.**

Need Help? Visit our website at **www.pyramat.com**, send an e-mail to **service@pyramat.com**
or call toll-free at **877-591-1012**.

Printed in China for:
Pyramat, LLC
PO Box 3610
Cerritos, CA 90703
© Copyright 2006 Pyramat, LLC