

# KENWOOD

sovereign  
Users' Guide

How To Operate And Enjoy Your  
VR-5900

Digital Audio/Video Receiver

# Using Your New Kenwood Audio-Video Receiver

Welcome to the Users' Guide for your new Kenwood Audio-Video Receiver.

The **VR-5900** connects all your current audio and video components. It allows you to control them all with Kenwood's remarkable PowerTouch touch screen remote—a graphical user interface without having to use your TV!

The **VR-5900** adds dual-zone/dual-source operation, letting you play two different A/V sources independently in two different rooms! For a match made in "dual-zone heaven," add Kenwood's dual-transport CD-2280M, or CD-3280M 200-Disc CD Changer to the **VR-5900**.

**NetFront™**  
Easy Communication Everywhere

NetFront® by Access Co., Ltd. is adopted for this product.

Copyright© 1996, 1997 Access Co., Ltd.

NetFront® is registered trademark of Access Co.,Ltd. in Japan.

# Table of Contents

<b>Chapter One: Moving Around .....</b>	<b>1</b>
<b>What's on the Front Panel of Your Kenwood Audio - Video Receiver? .....</b>	<b>2</b>
<b>What's on PowerTouch? .....</b>	<b>3</b>
What's on PowerTouch's Screen? .....	4
The Quick Access Menu: .....	5
<b>How is PowerTouch Powered? .....</b>	<b>5</b>
<b>How Do I Use PowerTouch? .....</b>	<b>6</b>
How Do I Move Around? .....	7
How Do I Enter Text? .....	8
<b>Chapter Two: Using PowerTouch .....</b>	<b>9</b>
<b>How Do I Adjust the Sound? .....</b>	<b>10</b>
Turning the Speakers On .....	10
Adjusting the Volume .....	11
Adjusting the Loudness (Only in STEREO mode with THX mode Off) .....	11
Adjusting the Tone (Only in STEREO mode with THX mode Off) .....	12
Adjusting Speaker Levels .....	13
Muting Sound .....	15
Midnight Theater Function (Dolby Digital, DTS and DTS-ES only) .....	16

To balance volume extremes .....	16
<b>How Do I Adjust the Surround modes? .....</b>	<b>17</b>
What are THX? .....	17
What are Listen Modes? .....	18
To check the Surround Play status .....	21
Input Modes .....	22
To Set the Input Mode manually .....	23
To Set the THX mode .....	24
To Set the Listen Mode manually .....	26
Selectable Listen modes .....	27
Selecting the Pro Logic mode with PowerTouch .....	28
Description of Dolby Pro Logic II: Music modes .....	29
Applying Digital Signal Processor (DSP) Effects .....	30
HDCD® and D.R.I.V.E. Effects (THX Off mode only ) .....	33
Headphone Operation .....	34
<b>How Do I Operate Devices? .....</b>	<b>35</b>
Operating PowerTouch without Sending Commands to the Receiver (Operations using the SHIFT key): .....	36
HOME1, HOME2 Devices .....	37
Playback of the device connected to the CD2/TAPE2 MONITOR .....	39
CD player .....	40
Kenwood System Connected 200-Disc CD Changer .....	40
To play KENWOOD 200-Disc CD Changer (without system connection) using PowerTouch: .....	46
SingleCD or Carrousel CD Player .....	51
CD-R Recorder .....	52
MD Recorder .....	53

Tape Deck .....	55
Turntable .....	56
Tuner .....	57
TV .....	62
VCR/PVR .....	66
DVD Player .....	67
Laser Disc Player .....	68
Operation on the More menu .....	69
How Do I Record (Edit Mode)? .....	59
Digital to Digital Recording: .....	61
Digital to Analog Recording: .....	61
How Do I Record (Edit Mode)? .....	70
<b>How Do I Adjust PowerTouch's Display? .....</b>	<b>73</b>
How Do I See PowerTouch's Screen More Clearly? .....	74
How Do I Turn the Beeping On or Off? .....	74
Using PowerTouch to Dim or Brighten the Receiver's Front Panel .....	75
<b>How Do I Perform Several Actions at Once? .....</b>	<b>76</b>
Creating Macros .....	77
Modifying a macro .....	78
Using Macros .....	80
<b>How Do I Control Home Automation Equipment? (for U.K. only) .....</b>	<b>82</b>
To switch on or switch off the RELAY CONTROL output using PowerTouch .....	82
X-10 Home Automation .....	83
Lutron .....	85

Makita .....	86
Accessories Control .....	88

## **Chapter Three: Using PowerTouch in Multiple Zones**

.....	<b>90</b>
How Do I Switch Control Modes? .....	91
Why Don't I See All My Devices? .....	92
How Do I Operate Devices? .....	93
Operating Devices in Zone A .....	93
Operating Devices in Zone B .....	93

## **Chapter Four: Troubleshooting .....** 94

<b>Sound .....</b>	<b>96</b>
I don't hear any sound at all .....	96
Audio is not output only when a 96k fs compatible disc is played. ....	96
I can't hear sound from one or more of the speakers, or the sound is abnormally low .....	96
The 96k fs indicator does not light while a 96k fs compatible disc is being played. ....	97
I can't hear sound from my surround or center speakers ...	97
I can hear sound only from the center speaker when Dolby Pro Logic is selected .....	97
A DTS-ES encoded source is played but it is not decoded in DTS-ES. ....	97
A Dolby Digital Surround EX-encoded source is played with THX Surround EX set to "Auto", but the source is not reproduced in 6.1-channel audio. ....	98
Sound from one (or more) of my devices is abnormally loud or soft. ....	98

I can't hear any sound in Zone B .....	99
I can't hear sound from some of my laser discs .....	99
There wasn't any sound recorded on tapes made on my VCR or tape deck .....	99
The initial sound is intermittent or non-existent when I start to play from a Dolby Digital, DTS, DTS-ES or MPEG source .....	100
With a Dolby Digital program or DTS program, the loud sounds aren't very loud and the quiet sounds aren't very quiet.....	100
All I hear is loud static when I play DTS discs .....	100
I hear a hum when I select the PHONO input .....	100
Audio is not output only when a 96 kfs compatible disc is played. ....	100
Sound is intermittent.....	100
<b>Video .....</b>	<b>101</b>
I can't see the program I'm playing on the TV	
There wasn't any video output to my VCR when I recorded .....	101
<b>PowerTouch .....</b>	<b>101</b>
I don't see icons for all my devices .....	101
I don't see icons for all the devices I set up .....	101
When I select a device icon, I don't see any commands ....	101
My PowerTouch is slow to respond—sometimes I have to press buttons or select commands several times .....	101
My PowerTouch is not responding .....	102
My PowerTouch is beeping. What does that mean? .....	102
PowerTouch does not "learn" new commands or functions .....	102

I want to clear all the items in PowerTouch and make it to the factory-set default condition. ....	102
<b>Receiver/Tuner</b> .....	<b>103</b>
My receiver won't turn on and the STANDBY indicator is flashing .....	103
The sound is distorted, and the CLIP indicator on the receiver's front panel flashes red continually, or stays red for more than 1 second at a time .....	104
I can't access any RDS (Radio Data System) functions (for U.K. only) .....	105
I can't receive a radio station .....	105
I'm getting a lot of static/interference .....	105
When I press a key to tune to a preset station, the receiver does not respond .....	105
Macro is not running as I programmed. ....	106



# Chapter One: Moving Around

Welcome to the Kenwood VR-5900 *Users' Guide*. This chapter explains the buttons and functions you can find on the front of the receiver and on the PowerTouch. The chapter also includes an explanation of how to navigate the convenient graphical display on your new PowerTouch.

It includes the following sections:

What's on the Front Panel of Your Kenwood Audio - Video Receiver?	page 2
What's on PowerTouch?	page 3
How is PowerTouch Powered?	page 5
How Do I Use PowerTouch?	page 6

## What's on the Front Panel of Your Kenwood Audio-Video Receiver?

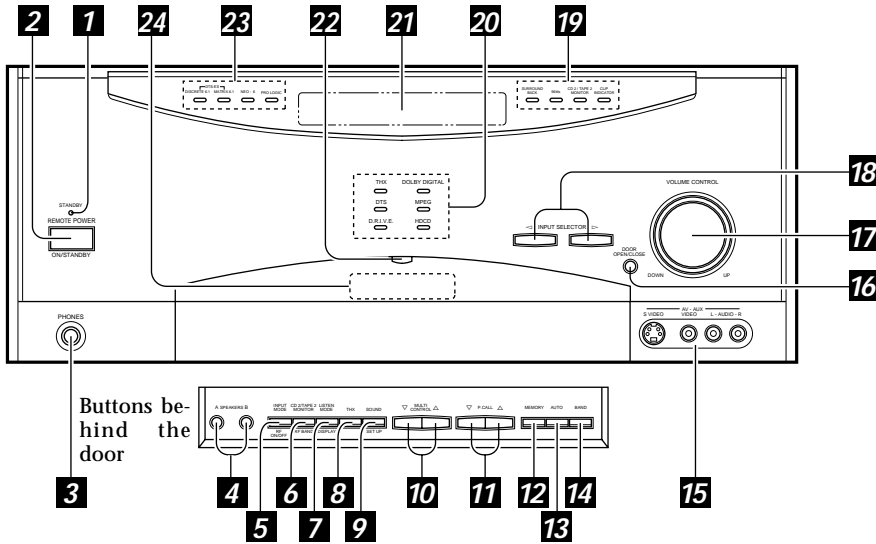

1. STANDBY indicator
2. REMOTE POWER ON/STANDBY button
3. PHONES jack
4. SPEAKERS A/B buttons
5. INPUT MODE button /  
RF ON/OFF button
6. CD 2/TAPE 2 MONITOR button /  
RF BAND button

7. LISTEN MODE button/DISPLAY button
8. THX button
9. SOUND button/SET UP button
10. MULTI CONTROL (Up/Down) buttons
11. P. CALL (Up/Down) buttons
12. MEMORY button
13. AUTO button
14. BAND button

15. AV-AUX input jacks
16. DOOR OPEN/CLOSE button
17. VOLUME CONTROL knob
18. INPUT SELECTOR buttons
19. Indicators

SURROUND BACK  
96 k fs  
CD2/TAPE2 MONITOR  
CLIP INDICATOR

20. Indicators

THX  
DTS  
D. R. I. V. E.  
DOLBY DIGITAL  
MPEG  
HDCD

21. Display
22. 2-way communication indicator
23. Indicators

DTS-ES DISCRETE 6.1  
DTS-ES MATRIX 6.1  
NEO : 6  
PRO LOGIC

24. Infrared remote transmitter

Buttons 4 to 14 are located behind the door.

### Standby mode

While the standby indicator of the unit is lit, a small amount of current is flowing into the unit's internal circuitry to back up the memory. This condition is referred to as the standby mode of the unit. While the unit is in the standby mode, it can be turned ON from the remote control unit.

What's on PowerTouch?

## What's on PowerTouch?

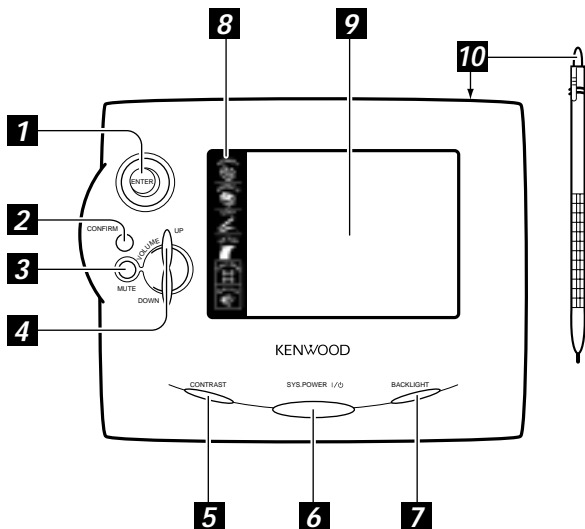

1. Joystick (see page 7)
2. CONFIRM button
3. MUTE button (see page 15)
4. VOLUME UP/DOWN button (see page 11)
5. CONTRAST button
6. SYS. POWER button
7. BACKLIGHT button (see page 73)
8. Quick Access menu
9. Touch screen display
10. Stylus (stored on top edge)

What's on PowerTouch?

### What's on PowerTouch's Screen?

PowerTouch's LCD display screen is divided into two sections: the Quick Access Menu and the Device Control/Menu Section. Use the stylus to touch the buttons in each area.

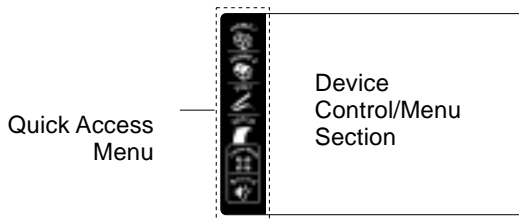

### An example of HOME 1 menu

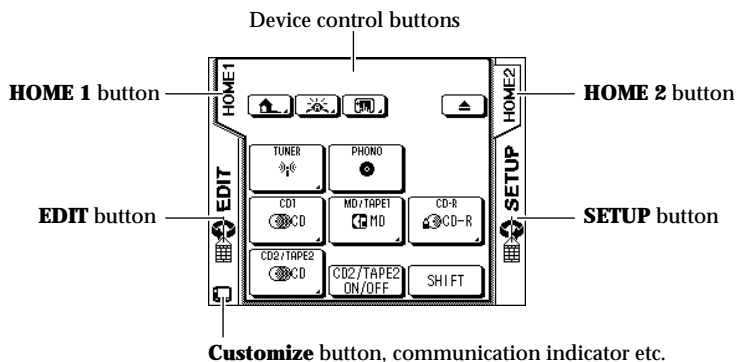

### The Quick Access Menu:

The buttons in the Quick Access Menu are always available, regardless of what else is displayed on the touch screen. Touch these buttons for instant access to:

- Home1, Home2 : Music and movie device controls such as CD players, the radio tuner or VCRs.
- Editing features
- Setup features
- Listen modes such as stereo, Dolby Digital or DTS
- Sound controls, such as loudness or "Midnight" mode

How is PowerTouch Powered ?

**The Device Control/Menu Section:** The device control section provides the same kinds of access as the Quick Access menu, but with more structure. Use the Main menu to navigate through the feature menus to exactly the feature or device you want to use.

Using these features, your Kenwood PowerTouch can store and display a large number of tasks, making it easier for you to access features. You get all the advantage of on-screen graphical display, without having to use a TV screen!

For more information on using these icons, see “How Do I Use PowerTouch?” on page 6.

## How is PowerTouch Powered ?

Your new PowerTouch uses four C (LR14) alkaline batteries and operates in the following range:

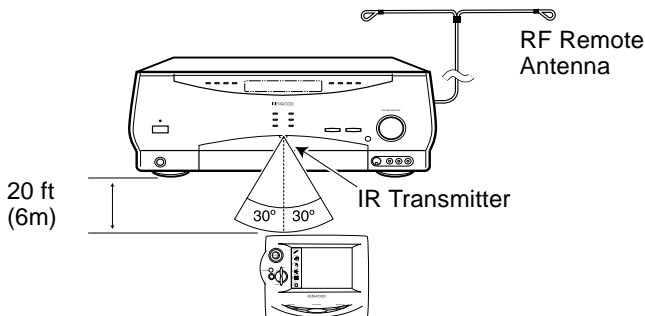

If you use PowerTouch outside of this range, PowerTouch's display may show incorrect information, or may not operate.

The remote control signal received by the main unit is only the RF signal. The control distance of the RF remote signal is about 10 meters provided there is no obstacle.

## How Do I Use PowerTouch?

As you use PowerTouch, be aware of the following:

- When PowerTouch's operating range gets shorter or PowerTouch displays a low battery alarm, replace all 6 batteries. (see "Installing the Batteries" on page 34 of the *Connections and Setup Guide*.)

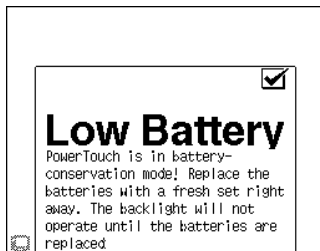

- Do not install the receiver where direct sunlight or high-frequency fluorescent lighting can shine directly into the infrared remote sensor. This can limit PowerTouch's operating range.

## How Do I Use PowerTouch?

Use your new PowerTouch to control your new receiver and most devices attached to it. PowerTouch appears and functions a little differently from traditional remotes. Because it can control so many different devices, it displays a separate set of controls for each device on an LCD screen.

Only devices you have identified and connected to the receiver appear as buttons on the touch screen. If you are "missing" a device's icon on the Home1 or Home2 screen, make sure you have identified the device to the PowerTouch. For more information on identifying devices to the PowerTouch, see "Chapter Two: Setting Up PowerTouch" in the *Connections and Setup Guide*.

## How Do I Use PowerTouch?



Do not block the IR transmitter on the front panel of the receiver or on PowerTouch. Even a brief blockage while it is transmitting (such as someone walking by) can cause the communication and feedback to become erratic temporarily. If this happens, press **CONFIRM** and PowerTouch will resume normal operation (you might need to reenter the interrupted command).

### How Do I Move Around?

1. Press any button or touch the screen to activate PowerTouch's display.
2. Use the stylus to touch the menu or control button you want to use.

### Operations using the joystick

The joystick makes the following operations possible.

1. Customization of the PowerTouch screen: The buttons on the screen of PowerTouch can be moved or resized. (Refer to "To Customize the PowerTouch Screen" on page 43 of the *Connection and Setup Guide*.)
2. Contrast adjustment of the PowerTouch screen: For details, see "To adjust the contrast" on page 74.

Also use the joystick when using the OSD (On-Screen Display) of the DVD or LD player. (Certain functions may be restricted with some devices.)

- Display a menu containing the OSD function.
- Press the OSD button or Menu. The menu is displayed on the TV monitor screen.
- Select an item by tilting the joystick up/down or to the left/right.
- Press the joystick's **ENTER** button to enter the selected item.  
(With certain models, the selected item may also be established with the other buttons.)





## How Do I Use PowerTouch?

**How Do I Enter Text?**

Many of the control menus allow you to assign your own names to list items (such as radio stations, CD titles, etc.).





To enter text for names:

1. Access the control screen with the item name you want to change.

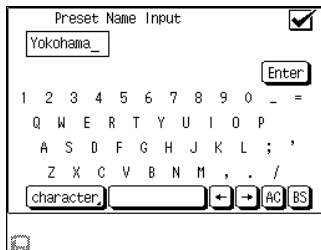
You have accessed the appropriate screen if , , , or  appears on the screen.

2. Touch , , , or  :



- Use the stylus to select characters from the keyboard.
- Touch  to access to lowercase characters. Touch it again to access special characters (such as @, !, &, etc.). Touch it a third time to return to uppercase characters.
- Touch  or  to move back and forth between the characters.
- Touch  to clear the last character you entered. Touch  to delete all the characters in the line.



## Chapter Two: Using PowerTouch

Your new receiver comes with the easiest—and most innovative—remote you've ever seen. Its palm-sized illuminated screen displays clear icons and menus. Because PowerTouch maintains two-way communication with your receiver, it shows the result of your action right on its screen.

PowerTouch is a universal remote that can control hundreds of devices, and is the first of its kind to offer infra-red compatibility with X-10, Lutron lighting, and Makita drapery control systems, making it perfect for controlling even the most elaborate home theater system. (for U.K. only)

This chapter contains the following sections:

How Do I Adjust the Sound?	page 10
How Do I Adjust the Surround modes?	page 17
How Do I Operate Devices?	page 35
HOME1, HOME2 Devices	page 37
How Do I Record? (Edit Mode)	page 70
How Do I Adjust PowerTouch's Display?	page 73
How Do I Perform Several Actions at Once?	page 76
How Do I Control Home Automation Equipment?	page 82

How Do I Adjust the Sound?

## How Do I Adjust the Sound?

You can control and adjust a variety of sound settings using the receiver's front panel or PowerTouch.

### Turning the Speakers On

To turn on the speakers A, press the **DOOR OPEN/CLOSE** button to open the door and press the **SPEAKERS A** button inside the door.

To turn on the speakers B, press the **SPEAKERS B** button located in the door of the receiver's front panel. (A or B displayed)

If you select **SPEAKERS B** (Zone B) while listening to a surround mode in Zone A, the sound in Zone A will automatically revert to stereo. While **SPEAKERS B** is on, surround mode cannot be selected.

If you use speakers connected to amplifiers via the **PRE OUT** jacks, choose **SPEAKERS A**.

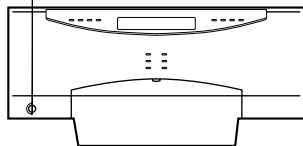
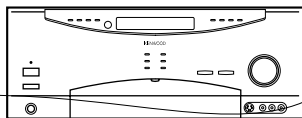

## Adjusting the Volume

Use one of the following methods to adjust the volume.

- Turn the volume knob on the front panel of the receiver.

- Press  in the appropriate direction on PowerTouch.



## Adjusting the Loudness (Only in STEREO mode with THX mode Off)

The Loudness control increases the bass and treble at low volume control settings. This adjusts to the way the human ear hears sound at quiet volumes, retaining music's fullness and sparkle.

1. Touch  (sound) on the Quick Access menu to open the Sound menu.

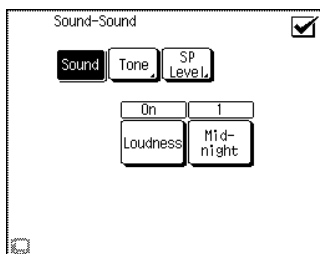
If the opened menu is not the Sound menu, touch .



2. Touch  to turn the loudness setting on or off.
3. Touch  to return to the previous menu or touch one of the Quick Access menu buttons to proceed to the next operation.

### Operation on the receiver:

1. Press the **SOUND** button inside the door repeatedly until **LOUDNESS OFF** or **ON** is displayed.
2. Press the **MULTI CONTROL** ( $\Delta/\nabla$ ) button to select **LOUDNESS ON** (or **OFF**), then press the **SOUND** button repeatedly until "**SOUND FIXED**" is displayed.

### Adjusting the Tone (Only in STEREO mode with THX mode Off)



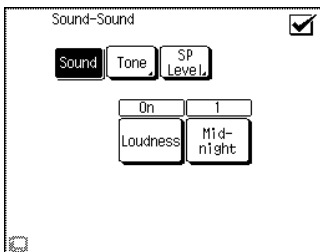

Use the Sound menu to adjust the bass or treble tone of your front left and right speakers manually. In addition to setting bass and treble tone adjustment values, you can completely bypass the tone control circuitry for a purer sound.

1. Touch  (sound) on the Quick Access menu to open the Sound menu:

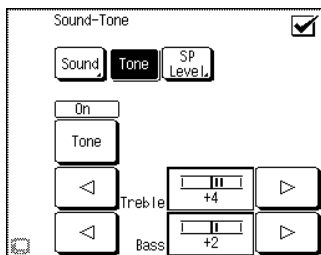

2. Touch  to open the Tone menu:



3. Touch  to turn the tone settings on or off.
4. If you selected "on" in the above, touch the left  or right  arrow next to a tone setting (Treble or Bass) to adjust it. A readout  between the arrows shows the current setting.

5. Touch  to return to the previous menu or touch any Quick Access menu button to access that menu.

-----  
**Operation on the receiver:**

1. Press the **SOUND** button in the door repeatedly until **TONE OFF** or **ON** is displayed.
2. Press the **MULTI CONTROL** ( $\Delta/\nabla$ ) button to display **TONE ON** (or **OFF** if desired so).
3. When **ON** is selected above and the **SOUND** button is pressed again, the **BASS** setting menu appears.  
When **OFF** is selected above, the **LOUDNESS** setting menu appears.
4. Adjust **BASS** level using the **MULTI CONTROL** ( $\Delta/\nabla$ ) button.
5. Press the **SOUND** button.
6. When the **TREBLE** setting menu appears, adjust the treble in the same way as above. To exit from setting, press the **SOUND** button repeatedly until "**SOUND FIXED**" is displayed.

**Adjusting Speaker Levels**

You can use the Sound menu to temporarily adjust the speaker levels of your center speaker, surround speakers, surround back speakers and subwoofer. For example, if a particular movie has dialog that's hard to understand, you can temporarily increase the center channel volume just for that movie. For more information on adjusting speaker levels permanently, see Chapter Two: Setting Up PowerTouch in the *Connections and Setup Guide*.

1. Touch  (sound) on the Quick Access menu to open the Sound menu:

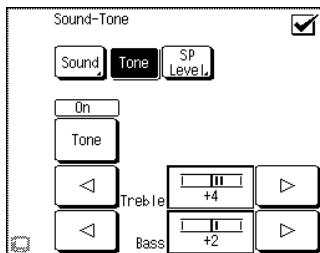

## How Do I Adjust the Sound?

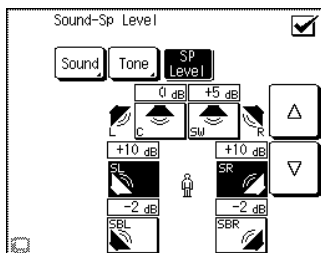

- Touch  to open the Speaker Level menu:



Although icons for the front speakers appear here, notice that they do not have buttons. They're here for a visual reference; you cannot change their level.

- Select a speaker by touching its button. You have selected a speaker when its button darkens.

The two surround speakers (SL and SR) or the two surround back speakers (SBL and SBR) cannot be adjusted independently between each other.

- Touch the up  or down arrow  to adjust the volume of the speaker(s) you chose.
- Touch  to return to the previous menu or touch any Quick Access menu button to access that menu.

The subwoofer level can be adjusted between +10 dB and -20 dB, and other speaker level can be adjusted between +10 dB and -10 dB.

-----  
**Operation on the receiver:**

1. Press the **SOUND** button inside the door repeatedly until the name of the speaker(s) to be adjusted is displayed.  
C : center speaker  
S : surround speakers  
SB : surround back speakers  
SW : subwoofer
2. Press the **MULTI CONTROL** ( $\Delta/\nabla$ ) button to select the desired volume level, then press the **SOUND** button repeatedly until "**SOUND FIXED**" is displayed.

These settings automatically return to the level you adjust on Chapter Two of *Connection and Setup Guide* whenever you select a different source device or turn the receiver's power off.

**Muting Sound**

Use following method to temporarily mute the sound:

- Press **MUTE** button on PowerTouch.

A "**Mute On**" message appears on the LCD screen for 3 seconds, then disappears. The **MUTE** indicator on the receiver panel blinks during muting.

Use one of the following methods to cancel muting:



- Press either **Mute** button again.
- Adjust the volume control on either the receiver or PowerTouch.

The **MUTE** indicator on the receiver panel goes off.



### Midnight Theater Function (Dolby Digital, DTS and DTS-ES only)

Any time you don't want to experience the loud and soft volume extremes of recorded sound (for example, late at night), use midnight Theater function to reduce volume extremes. This feature keeps loud, dramatic sound from being too loud (perhaps disturbing family members or neighbors) while ensuring that you can still hear whispered dialog or other soft sounds. Midnight theater function only works if you are listening to a Dolby Digital, DTS or DTS-ES program that has been encoded with special compression data.

#### To balance volume extremes

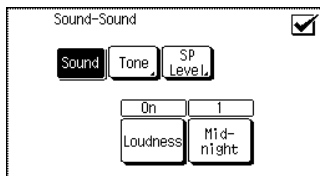
1. Touch  (sound) on the Quick Access menu to open the Sound menu:  
If the opened menu is not the Sound menu, touch .



2. Touch  until the balancing sounds right to you:
  - **OFF** for normal balancing
  - **1** for quieter balancing
  - **2** for quietest balancing (the least difference between the loudest and quietest sound)
3. Touch  to return to the previous menu or touch one of the Quick Access menu buttons to proceed to the next operation.

---

#### Operation on the receiver:

1. Press the **SOUND** button in the panel door repeatedly until **MID-NIGHT OFF**, **1** or **2** is displayed.
2. Press the **MULTI CONTROL** ( $\Delta/\nabla$ ) button to select **1**, **2** or **OFF**, then press the **SOUND** button repeatedly until returning to the previous menu.



## How Do I Adjust the Surround modes?

You can experience true home-theater sound with your Kenwood Audio-Video Receiver. This receiver incorporates several listen modes to let you enjoy surround sound with a wide variety of program sources. Each produces multiple channels of surround-sound, but each does it differently.

### What are THX?

- **THX:** Movie soundtracks are mixed in special movie theaters called dubbing stages and are designed to be played back in movie theaters with similar equipment and conditions. The soundtrack created for movie theaters is then transferred directly onto Laserdisc, VHS tape, DVD, etc., and is not changed for playback in a small home theater environment.

THX engineers developed patented technologies to accurately translate the sound from the movie theater environment into the home, correcting the tonal and spatial errors that occur. On the VR-5900, when the THX mode is on, the THX technologies are automatically added after the decoded signal.

Movies which have been encoded in Dolby Digital, DTS, MPEG, Dolby Pro Logic, Stereo and Mono can all benefit from activating the THX technologies. THX should be activated only when watching movies which were mixed for playback in large movie theater environments. THX need not be activated for music, movies that were made especially for television or shows such as sports programming, talk shows, etc. This is because they were mixed in a small room environment.

- **THX Surround EX:** Lucas Film and Dolby Laboratories jointly developed the Dolby Digital Surround EX system, which is a cinema surround sound system featuring improved special representation and acoustic imaging of surround channels.

To allow the home theater environment to reproduce this surround sound by translating the above technology, the VR-5900 incorporates a THX Surround EX decoder.

This circuit features merges the matrix decoding technology with the Lucas Film's proprietary THX processor technology and adds the surround back (SB) channels to offer clearer acoustic positioning on the rear, spatial expression and the feeling of movement between the front and rear.

The surround back (SB) signals are encoded in the surround channels (SL, SR) and decoded to the SL, SR and SB channels during playback. The THX processor then corrects these signals to match the home theater reproduction and outputs them in the 6.1-channel signals.

### What are Listen Modes?

- **Dolby Digital:** Dolby Digital uses an encode/decode process based on its theatrical digital surround sound technology. The five main channels are full-frequency and independent, so sound can completely envelop you or soar anywhere in the room, just like at the movies.

Compared with Dolby Pro Logic, Dolby Digital has more clarity, greater surround envelopment, and more realistic sound movement between channels.

Although a full set of speakers (front left and right, center, surround left and right, and a subwoofer) is required for true Dolby Digital surround sound, this receiver lets you enjoy Dolby Digital program sources, even if you connect fewer speakers.

- **DTS :** DTS has five full-frequency channels that create effects nearly identical to those in a theater. Sounds seem to zoom from one place to another or entirely surround you. Like Dolby Digital, DTS has much-improved clarity, surround and sound movement capability compared with Dolby Pro Logic. This listen mode is available on CD, LD, and DVD media. DTS is a strictly digital format that can be supplied only by a CD, LD, or DVD player that supports DTS sound. If you attempt to listen to DTS encoded media through the analog connections to your new receiver, you will experience digital noise (loud static).
- **DTS-ES Discrete 6.1, DTS-EX Matrix 6.1:** Both DTS-ES Discrete 6.1 and DTS-ES Matrix 6.1 add the surround back channel audio to the DTS 5.1-channel format to improve the acoustic positioning and makes acoustic image movement more natural with the 6.1-channel reproduction. This receiver incorporates a DTS-ES decoder, which can handle DTS-ES Discrete-encoded and DTS-ES Matrix-encoded program sources from DVD, etc.

DTS-ES Discrete 6.1 features digital discrete recording of all channels including the surround back channels and higher quality of audio reproduction.

DTS-ES Matrix 6.1 features matrix encoding of surround back (SB) signals in the SL/SR signals and decoding of the matrix into the SL, SR and SB signals during playback.

- **MPEG:** MPEG, which stands for “Moving Pictures Experts Group”, is an international standard of digital video and audio compression and decompression in media. It is the most efficient encoding method for compressed multi-channel audio which provides the highest sound quality to deliver the best movie theater sound into the home.
- **Dolby Pro Logic/Dolby Pro Logic II:** Dolby Pro Logic reproduces a surround sound like in a movie theater from Dolby Surround-encoded program source (videotape or LaserDisc software carrying the Dolby Surround logo), and features excellent sound movement on the front and a surrounding atmosphere of movie theaters. Meanwhile, Dolby Pro Logic II decodes a signal encoded in 2 channels into 4-channel signals composed of the left/right front signals, center signal and surround signal.

Dolby Pro Logic II is an advanced version of the decoding technology used with Dolby Pro Logic. It inputs 2-channel signals from a Dolby Surround-encoded source and reproduces 5.1-channel signals in which the surround channel is divided into independent channels for the left and right. Dolby Pro Logic II has the MOVIE mode and MUSIC mode, and the MUSIC mode enables independent adjustment of three parameters including Panorama mode, Dimension and Center Width. See page 29 for the Dolby Pro Logic II parameters.

To allow the users enjoy multichannel playback also from the analog audio of currently available Dolby Surround home video software, the VR-5900 incorporates a Dolby Pro Logic II surround decoder.

- **DTS NEO:6:** This is a new technology which decodes 2-channel signals into 6-channel signals using high-accuracy digital matrix technology. The DTS NEO:6 decoder has near-discrete properties in the frequency characteristics of the channels as well as in channel separation. According to the signals to be played back, DTS NEO:6 uses either the NEO:CINEMA mode optimized for movie playback or the NEO:MUSIC mode optimized for music playback.

How Do I Adjust the Surround?

- **DSP (Digital Signal Processing):** DSP allows you to create your own custom surround sound environments and use them with any source (except Dolby Digital, MPEG, DTS and DTS-ES). You can select the ambience of an Arena, Jazz Club, Stadium, Cathedral or Theater, and then modify the parameters to 'fine-tune' the environment to your taste. (See "Applying Digital Signal Processor (DSP) Effects" on page 30 for details about making DSP adjustments.)
- **Multi ch Music (Multichannel music):** All speakers are used to realize a stereo sound with a wide listening range.
- **Stereo:** Stereo listen mode provides standard stereo sound to the front left and right speakers.



You cannot select the Input Analog mode if you are playing DTS-encoded media.

You cannot listen to DTS-encoded media in Zone B.

When playing DTS-encoded media, wait until "DTS" appears on the receiver display before proceeding.

The listen mode is fixed to Stereo during playback of 96k fs signals.

## To check the Surround Play status

1. Touch  (listen mode) on the Quick Access menu to open the Listen Mode menu:

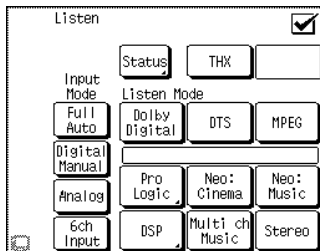

2. Touch . This displays the Input Signal Status screen, which shows the signal being displayed:

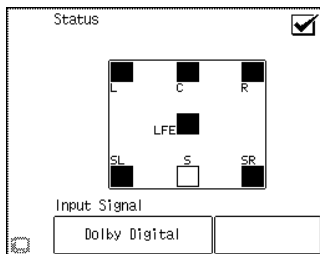

During playback of Dolby Digital, MPEG or DTS signal, the surround identification signal in the input is identified and displayed by means of the L, C, R, SR, SB, SL and LFE icons.

- |                                    |                             |
|------------------------------------|-----------------------------|
| L : Left front channel             | C : Center channel          |
| R : Right channel                  | SR : Surround right channel |
| SL : Surround left channel         | SB : Surround back channel  |
| LFE : Low frequency effect channel | S : Surround channel        |

3. Touch  to return to the previous menu or touch one of the Quick Access menu buttons to proceed to the next operation.

## Input Modes

The input mode should usually be set to Full Auto. However, the input mode can also be set manually when you want to fix the inputs as analog signals, etc.

**Full Auto** : The receiver detects the input signal format and selects the Listen mode automatically according to the speaker setup.

**Digital Manual** : The inputs are fixed at digital signals and the listen modes should be switched manually by the user.

The **Digital Manual** mode is switched automatically to the **Full Auto** mode when an input is switched or the receiver is set to **OFF**.

**Analog** : The inputs are fixed at the analog 2-channel inputs.

**6ch Input** : The inputs are fixed at the analog 6-channel inputs. This mode can be selected only when the DVD input is selected with the input selector.

## NOTES

- When you use **Full Auto** mode with certain DVD and LD players, performing operations such as "Skip" or "Stop" may momentarily interrupt the output. This could switch the "Listen Mode" automatically to the surround mode intended for the input signal if you have manually selected a different listen mode.

## To Set the Input Mode manually

1. Touch  (listen mode) on the Quick Access menu to open the Listen Mode menu:

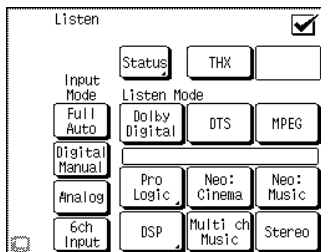

2. Select an Input Mode you want.

To fully enjoy the sonic benefits of specially-encoded DVD AUDIO discs played on a compatible DVD player, you must set the receiver's input to **6ch Input**. To do so, select .

When you are finished listening to analog media, set the receiver's input back to digital. To do so, select the .

---

### Operation on the receiver:

Press the **INPUT MODE** button in the door repeatedly until **FULL AUTO**, **DIGITAL-MANUAL**, **ANALOG** or **6CH INPUT** is displayed.

## NOTES

See Chapter Three: Using PowerTouch in Multiple Zones for more information about the analog inputs.

## To Set the THX mode

1. Touch  (Listen Mode) on the Quick Access menu to open the Listen Mode menu.

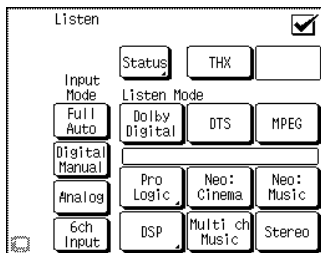

2. Touch  until the THX mode to be set is displayed.

The THX mode is displayed in a frame at the top right of the screen.

When the surround back speakers are set to **Lrg, Nml/THX** or **Yes**:

- ① THX Sur EX On
- ② THX Sur EX Auto
- ③ THX On
- ④ THX Off

When the surround back speakers are set to **Off** or **No**:

- ① THX On
- ② THX Off

---

### Operation on the receiver:

Press the **THX** button inside the door repeatedly until the THX mode to be set is displayed.

When the surround back speakers are set to **Lrg, Nml/THX** or **Yes**:

- ① THX Sur EX On
- ② THX Sur EX Auto
- ③ THX On
- ④ THX Off

When the surround back speakers are set to **Off** or **No**:

- ① THX On
- ② THX Off

After 3 seconds, the display of the set THX mode returns to the previous display.



## How Do I Adjust the Surround?

- **THX Sur EX ON**

The input signal is decoded automatically into 6.1-channel signals if the input signal is Dolby Digital or DTS and contains two different types of surround channel signals.

The THX function is activated.

- **THX Sur EX AUTO**

The input signal is decoded into 6.1-channel signals only when the input contains the Dolby Digital Surround EX encoded identification signal.

The THX function is activated

- **THX ON**

The THX operation is activated. (6.1 channel decoding will not be applied.)

- **THX OFF**

The THX Surround EX and THX operations are deactivated.

## NOTES

- When playing **Dolby Digital Surround EX**-encoded software in 6.1 channels, it is required to set the **THX Surround EX** mode to On or Auto. Note that some of **Dolby Digital Surround EX**-encoded software does not contain the identification signal. In this case, set the **THX Sur EX** mode to On.
- Set the **THX** mode to Off when **DTS-ES** decoding is required.
- The **THX** operation is not activated with the 96 k fs PCM signal.

## To Set the Listen Mode manually

1. Touch  (Listen Mode) on the Quick Access menu to open the Listen Mode menu:

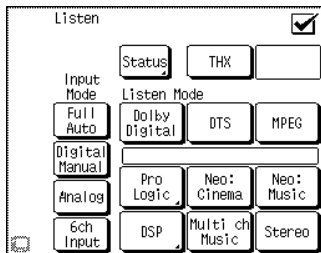

2. Select a Listen Mode you want.

### Operation on the receiver:

Press the **LISTEN MODE** button inside the door repeatedly until the listen mode to be set is displayed.

After 5 seconds, the display of the set listen mode returns to the previous display.

## NOTES

- The available listen modes may be restricted depending on the input signal and speaker setup.
- In **FULL AUTO** mode, if the incoming signal is not **Dolby Digital**, **DTS**, **DTS-ES** or **MPEG**, the listen mode reverts to the last listen mode you selected for that input.
- When the speakers A are set to Off or speakers B are set to On, the listen mode is switched to STEREO.

### Selectable Listen modes

The selected listen mode is variable depending on the input signal.

Input signal	Selectable Listen modes
<b>Dolby Digital</b>	<ul style="list-style-type: none"> <li>• Dolby Digital*</li> <li>• Pro Logic (ProLogic II MUSIC/MOVIE)**</li> <li>• Stereo</li> </ul> <p>* When the input signal contains the identification signal indicating Dolby Surround encoding, The listen mode is switched automatically to Pro Logic (Pro Logic II MUSIC/MOVIE).</p> <p>** Pro Logic (Pro Logic II MUSIC/MOVIE) can be selected only when the input is 2-channel signals.</p>
<b>DTS</b>	<ul style="list-style-type: none"> <li>• DTS</li> <li>• STEREO</li> </ul>
<b>DTS-ES Matrix 6.1</b>	<ul style="list-style-type: none"> <li>• DTS (DTS-ES Mtrx 6.1*)</li> <li>• STEREO</li> </ul> <p>*DTS-ES Matrix 6.1 can be selected only when THX mode is OFF.</p>
<b>DTS-ES Discrete 6.1</b>	<ul style="list-style-type: none"> <li>• DTS (DTS-ES Dscrt 6.1*)</li> <li>• STEREO</li> </ul> <p>*DTS-ES Discrete 6.1 can be selected only when THX mode is OFF.</p>
<b>MPEG</b>	<ul style="list-style-type: none"> <li>• MPEG*</li> <li>• Stereo</li> </ul> <p>*When the input signal contains the identification signal indicating Dolby Surround encoding, The listen mode is switched automatically to Pro Logic.</p>

Input signal	Selectable Listen modes
<b>PCM or Analog</b>	<ul style="list-style-type: none"> <li>• Stereo*</li> <li>• DSP**</li> <li>• Pro Logic (ProLogic II MUSIC/MOVIE)</li> <li>• NEO : Cinema</li> <li>• NEO : Music</li> <li>• Multi ch Music</li> </ul> <p>* When the input is a 96 kfs PCM signal, it is only Stereo that can be selected.</p> <p>** DSP Modes can be selected only when THX mode is OFF.</p>

## NOTES

Some modes may be unable to be selected depending on the speaker setup.





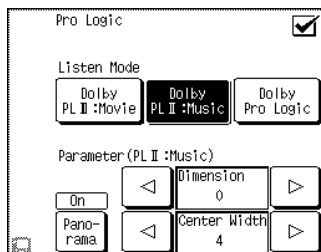



### Selecting the Pro Logic mode with PowerTouch

1. In the Listen Mode menu, select **Pro Logic** to display the following menu:



2. Select one of **Dolby PL II: Movie (Dolby Pro Logic II: Movie)**, **Dolby PL II: Music (Dolby Pro Logic II: Music)** and **Dolby Pro Logic**. The selected item will be displayed in highlighted.

3. When you select **Dolby PL II: Music**, you can change the settings of Panorama mode, Dimension and Center Width.

- 1) **Panorama** mode setting: Touch the  button to switch the parameter on and off alternately.
- 2) **Dimension** setting: Touch the  button on the left of  to switch the setting to R-1, R-2 and R-3. Touch the  button on the right of  to switch it to F-1, F-2 and F-3.
- 3) **Center Width** setting: Touch the  button on the left of  to decrease the expansion to the left and right. Touch the  button on the right of  to increase it.

### Description of Dolby Pro Logic II: Music mode

**Panorama mode:** Expands the image of front-channel stereo to the surround speakers to create a sound environment that fills your surroundings.

**Dimension** : This controls the balance between the Front and Rear in 3 steps on the front and 3 steps on the rear. Set this parameter to one of the Front steps if the surround effect is too strong, or to one of the Back steps if it is too weak.

**Center Width** : The center channel signal can be divided and distributed to the Front L/R channels.

The adjustment for distributing the center channel signal to the front channels can be applied in eight steps from 0 to 7.

Use this adjustment when the center image seems to be too strong.

The Center Width parameter has no effect when Center speaker is set to Off or No.

### Applying Digital Signal Processor (DSP) Effects

The DSP mode creates the reverberation devices (elements of sound echoed in various spaces) which determine the feeling of presence. Since DSP uses digital processing, it can produce these effects without spoiling the sound quality of the original music or video source.

The DSP mode lets you add the atmosphere of an Arena, Jazz club, Cathedral, Concert hall, Stadium, or Theater from PCM or analog input source. These modes are particularly effective when used with stereo program sources like CD, television, and FM radio. You might enjoy trying the Stadium (1, 2), Arena or Concert hall mode the next time you watch a sporting event or concert.

You can adjust the following elements to create a customized environment:

- The **WALL TYPE** parameter lets you adjust the brightness of the sonic environment according to your preference.
- The **ROOM SIZE** parameter lets you adjust the size of the sonic environment according to your preference.
- The **EFFECT level** lets you adjust the amount of DSP “presence” in the sonic environment according to your preference.





The DSP effect cannot be applied when the input is a 96 k fs PCM signal.

## How Do I Adjust the Surround?

### To set a DSP effect:

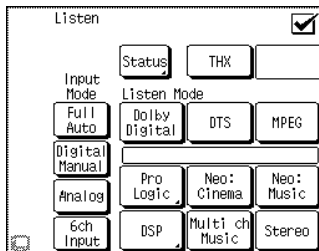
1. Touch  (listen mode) on the Quick Access menu to open the Listen Mode menu:



2. Touch .



3. Touch a desired DSP mode icon button.

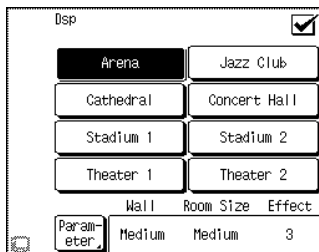

How Do I Adjust the Surround?

4. (Optional) Touch **Parameter** to adjust the wall type, room size, and effect level to your taste.

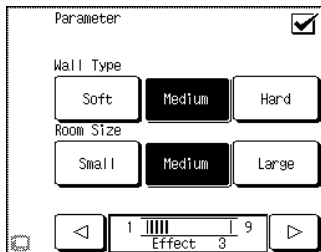

- **Wall Type** changes the quality of the simulated walls.
  - **Room Size** switches the simulated room size.
  - **Effect Level** adjusts the amount of DSP presence in the overall sound. Lower numbers decrease the amount of presence, higher numbers increase it.
5. Touch  to return to the previous menu or touch one of the Quick Access menu buttons to proceed to the next operation.

#### Operation on the receiver:

- Press the **LISTEN MODE** button inside the door repeatedly until the listen mode to be set is displayed. The DSP can be set to **ARENA**, **JAZZ CLUB**, **CATHEDRAL**, **CONCERT HALL**, **STADIUM 1**, **STADIUM 2**, **THEATER 1** or **THEATER 2**.

Fine adjusting the DSP effects on the receiver:

1. Press the **SOUND** button inside the door to select **WALL MEDIUM (HARD or SOFT)**.
2. Press the **MULTI CONTROL** ( $\nabla/\Delta$ ) button to select the desired type.
3. Select the types of Room size and Effect level in the same way as above.
4. Press the **SOUND** button repeatedly until "**SOUND FIXED**" is displayed.



How Do I Adjust the Surround?

## **HDCD® and D.R.I.V.E. Effects**

HDCD is a new format enabling recording with higher quality than previous CD while maintaining compatibility with it. Although an HDCD-compatible CD player is usually required to exhibit the full characteristics of the HDCD, this receiver is capable of reproducing high-quality HDCD signals by connecting a CD player through digital connection, even when it does not incorporate the HDCD circuitry.

D.R.I.V.E. is a KENWOOD original technology for reproducing signals with high resolution by instant switching of the internal filters according to the input signal. This receiver incorporate a high performance DSP to provide very high resolution from 32-bit DRIVE III circuitry, achieving stereo audio reproduction with the best quality ever reached.

The D.R.I.V.E. indicator lights when the D.R.I.V.E. circuit is activated.

The HDCD indicator lights when the HDCD circuit is activated and an HDCD is played.

HDCD and D.R.I.V.E. are designed to be activated automatically to select the optimum circuit path.

## NOTES

HDCD and D.R.I.V.E. is effective only at the time of digital input stereo, DSP mode or multi channel audio.

Some HDCD-recorded discs do not contain all tracks as HDCD recordings. (The HDCD indicator will not light for tracks not recorded as HDCD.)

HDCD and D.R.I.V.E. is effective only at the time of THX Off mode.

 HDCD®, High Definition Compatible Digital® and Pacific Microsonics™ are either registered trademarks or trademarks of Pacific Microsonics, Inc. in the United States and/or other countries. HDCD system manufactured under license from Pacific Microsonics, Inc. This product is covered by one or more of the following: IN the USA: 5,479,168, 5,638,074, 5,640,161, 5,808,574, 5,838,274, 5,854,600, 5,864,311, 5,872,531, and in Australia: 669114. Other patents pending.

How Do I Adjust the Surround?

### **Headphone Operation**

Insert the headphone plug into the receiver's PHONES jack and adjust the listening level.

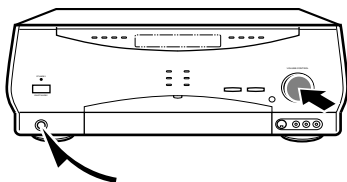

## How Do I Operate Devices?

Your PowerTouch makes it easy for you to control the different devices connected to your receiver. Its easy-to-use LCD screen provides a choice of command buttons similar to those found on the devices' own remotes. Use these buttons to control your home entertainment equipment by following these easy steps:

1. Choose the menu containing the device you want to use (HOME1 or HOME2).

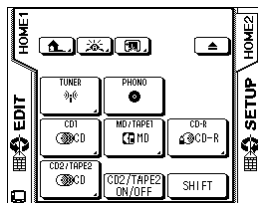

2. Touch the icon button for the device you want to operate from PowerTouch's control screen.

When the TV source is set for TV1, The Power control icons for TV1 will be displayed in the same position of all of the Device control screens, allowing you to switch the TV On and Off.

Example of display when CD is selected

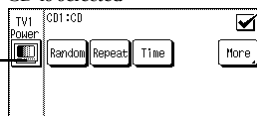

3. Touch a button on the device's control screen.

The rest of this manual assumes that you have connected your home entertainment devices and identified those devices to PowerTouch. **If you have not done so, follow the instructions under "Identifying Devices For PowerTouch Control" on page 40 of the *Connections and Setup Guide* before reading any further in this manual.** If you do not, you will not see controls for any device except for the factory-defined devices, such as the tuner and the home automation devices.



As you use PowerTouch, remember that this manual only gives instructions for operating PowerTouch with a particular device. It is not intended to explain how your devices work—for that information see the manuals that came with your devices.

Although the receiver has been designed to function in combination with multiple devices, all or some of the operations may not be available with certain types of devices.

### Controlling a device without altering the receiver's input selection (Operations using the SHIFT button):

The transmission of operation signals from PowerTouch to the receiver can be disabled with the HOME1 or HOME2 menu. This makes it possible, for example, to turn the VCR ON while listening to a CD.

Procedure:

1. Touch  (HOME1) or  (HOME2) in the Quick Access menu to display the HOME1 or HOME2 menu.

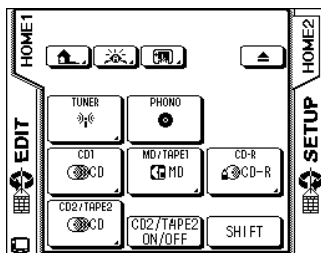

2. Touch  button.
3. Touch the desired operation button within 3 seconds after above.

By touching the SHIFT button and executing an operation, any device can be controlled without sending the command signal to the receiver. The above operation is not available with devices connected using the KENWOOD system control cable.

## HOME1, HOME2 Devices

Use this menu to operate devices, such as CD players, the tuner, etc.

By using the customization function, you can place buttons in the Home 1 screen on then Home 2 screen and vice versa. (Refer to "To Customize the PowerTouch Screen" on page 45 of the *Connection and Setup Guide*.)

This menu controls the following (note which device you have connected to the jack in the space provided):

I should use  
this icon...

to control this device...  
(use this space to note your devices)

Icons assigned to the Home 1 screen by default.



—



—



The operation of the **CD2/TAPE2** icon is different from other icons. See page 39 for details.

## How Do I Operate Devices?

I should use  
this icon...

to control this device...  
(use this space to note your devices)



Icons assigned to the Home 2 screen by default.





## Playback of the device connected to the CD2/TAPE2 MONITOR

These instructions are for operating a second CD player or tape deck from a single-Zone installation or from Zone A. For more information on operating devices in a multi-Zone setup, see “Chapter Three: Using PowerTouch in Multiple Zones”.

### To operate a second CD player or tape deck:

1. Touch  (HOME1) on the Quick Access menu.
2. Touch  (CD2/TAPE2 ON/OFF). The **CD2/TAPE2 MONITOR** indicator on the receiver also lights up. In this condition, the device connected to the **CD2/TAPE2** inputs can be monitored.

Each touch of  toggles its condition between **ON** and **OFF**. After completing playback of the device connected to the **CD2/TAPE2 MONITOR**, be sure to set this condition to **OFF**.

3. Touch . The commands appear for the device you connected to this jack set and identified to PowerTouch.
4. Use the available commands as your CD player or tape deck remote.

Touch  (more) to access any customized commands you have taught PowerTouch for this device. Touch the command to use it.

For more information on teaching commands to PowerTouch, see “To Customize the PowerTouch Screen” on page 43 of the *Connections and Setup Guide*.

---

To select the input on the receiver, use the **CD2/TAPE2 MONITOR** button inside the door. The **CD2/TAPE2 MONITOR** indicator lights up when it is selected. After completion of playback, press the **CD2/TAPE2 MONITOR** button again so that the **CD2/TAPE2 MONITOR** indicator goes out.

## CD player



The displayed screen is variable depending on the loaded CD.

- For the operation of the Kenwood System Connected 200-Disc CD Changer, see this page.
- For the operation of the KENWOOD 200-Disc CD Canger (without system connection), see page 46.
- For the operation of the SingleCD or Carrousel CD Player, see page 51.

## Kenwood System Connected 200-Disc CD Changer

Kenwood 200-Disc CD Changers have many different features that make them ideal complements to your Kenwood receiver. Some changer models can store disc and track titles for all loaded discs, and then download this information to your receiver for display on PowerTouch's screen. Others can play 2 different CDs in 2 different rooms at the same time with the KRF-X9995D. You can easily activate all these features using just a few of PowerTouch's buttons.

### To play KENWOOD System Connected 200-Disc CD Canger using PowerTouch

1. Touch  (HOME1) on the Quick Access menu.
2. Touch . This accesses the CD controls:

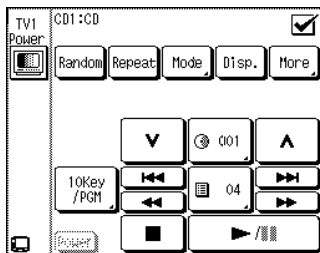



3. Use this screen as your CD remote.

Touch  (more) to access any customized commands you have taught PowerTouch for this device and to access this device's macros. Touch the command or macro name to use it. (See "Operation on the More menu" on page 69 of this manual.)

For more information on teaching commands to PowerTouch, see "To Customize the PowerTouch Screen" on page 43 of the *Connections and Setup Guide*. For more information on device macros, see "How Do I Perform Several Actions at Once?" on page 76 of this manual.

For more information on operating a CD player from another Zone, see "Chapter Three: Using PowerTouch in Multiple Zones".



### Displaying Disc and Track Titles

Kenwood 200-Disc CD Changers allow you to easily search for and select a particular CD or song by title from any disc you've loaded into the unit. PowerTouch can display these disc and track titles on its LCD display, allowing you to choose discs and songs by title in a few simple steps.

## NOTES

You have to assign disc and track titles to the discs in your CD player before you can transfer them to PowerTouch. See your CD player's instruction manual for more information about assigning disc and track titles.



### To read the loaded disc titles and store them in PowerTouch:

1. Touch  (HOME1) on the Quick Access menu.
2. Touch  (CD1).

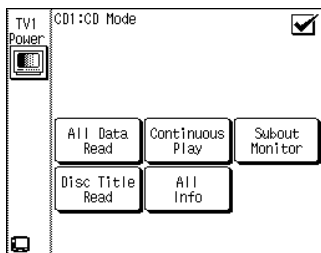

## How Do I Operate Devices?





3. Touch . This accesses the disc mode commands:



4. If you haven't already done so on the CD changer, touch . This reads all of the disc and track title information into the CD changer's memory.
5. Set PowerTouch down so that its IR transmitter window is aiming at the receiver's IR transmitter window. Select . Do not move PowerTouch while it is reading data.
- This process may take some time, depending on how many CDs you have loaded. When the IR light on the receiver goes out, the receiver is done sending the information to PowerTouch, and you may move PowerTouch again. PowerTouch's memory now contains the disc titles of every CD in the changer with title information.
6. Touch  to return to the CD controls.

**To read the loaded track titles and store them in PowerTouch:**





1. Make sure you have followed the previous instructions to read disc data.
2. Touch  (HOME1) on Quick Access menu.
3. Touch .
4. Touch . This accesses the disc mode commands

- If you haven't already done so on the CD changer, touch . This reads all of the disc and track title information into the CD changer's memory. Touch  to return to the CD controls.
- Select the disc you want to play and touch  to open the track controls.
- Set PowerTouch down so that its IR transmitter window is aiming at the receiver's IR transmitter window. Touch . Do not move PowerTouch while it is reading data.  
This process may take some time, depending on how many CDs you have loaded. You will see the track titles on the PowerTouch when it is finished reading data.
- Touch  to return to the CD controls.

### Entering Disc and Track Titles

You can also use PowerTouch to enter disc or track titles, if they are not already stored on the changer. The titles you add are stored in memory on both PowerTouch and the changer.

#### To enter disc or track titles:

- Touch  (HOME1) on the Quick Access menu.
- Touch .
- Stop playing a CD. (if it is playing)
- Touch  or . This accesses the appropriate control commands.

If you pressed , you will be entering track titles for the currently selected disc.

## How Do I Operate Devices?

5. Touch the disc or track name you want to change. See “How Do I Enter Text” on page 8 for more information on changing names.
6. Press .
7. Repeat steps 5 and 6 for each title you want to store.
8. Touch  to return to the disc or track controls. Touch it again to return to the CD controls.

## NOTES



If you rearrange or add new CDs to the changer, you will need to repeat both the disc and track read process. Otherwise, disc information is stored in PowerTouch permanently.

The track title information is not stored permanently in PowerTouch. Each time you select a CD to play you have to download its track title information.







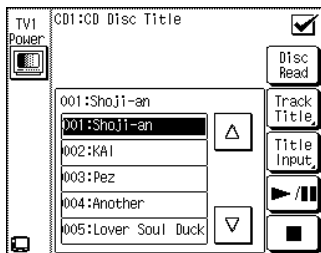

Title reading by PowerTouch is not possible for the following models.

Model: CD-2280M and CD-2260M.



### To play discs and tracks by title:

1. Touch  (HOME1) on the Quick Access menu.
2. Touch  button.
3. Touch . This accesses the disc commands:



4. Titles of all discs in the changer are displayed in numerical order.
5. Use the up  or down arrow  to scroll through the discs numerically, then touch the disc title you want to play.
6. If you want to play the disc from the beginning, touch .
7. (Optional) Touch . The track titles for that disc are displayed in numerical order.
8. If you want to play the disc starting from a particular track, use the up  or down arrow  to scroll through the track titles, then touch the track title.
9. When you've highlighted the track you want to begin playing, touch .
10. Touch  to return to the CD controls.

## To play KENWOOD 200-Disc CD Changer (without system connection) using PowerTouch

1. Touch  (HOME1) on the Quick Access menu.
2. Touch  button . This accesses the CD controls:

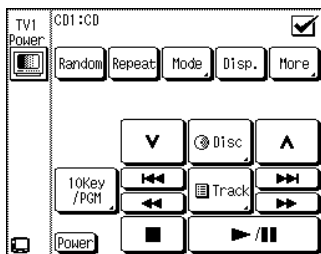

3. Use this screen as your CD remote.

Touch  (more) to access any customized commands you have taught PowerTouch for this device and to access this device's macros. Touch the command or macro name to use it.

For more information on teaching commands to PowerTouch, see "To Customize the PowerTouch Screen" on page 43 of the *Connections and Setup Guide*. For more information on device macros, see "How Do I Perform Several Actions at Once?" on page 76 of this manual.

For more information on operating a CD player from another Zone, see "Chapter Three: Using PowerTouch in Multiple Zones".



### Displaying Disc and Track Titles

Kenwood 200-Disc CD Changers allow you to easily search for and select a particular CD or song by title from any disc you've loaded into the unit. PowerTouch can display these disc and track titles on its LCD display, allowing you to choose discs and songs by title in a few simple steps.



## NOTES

You have to assign disc and track titles to the discs in your CD player before you can transfer them to PowerTouch. See your CD player's instruction manual for more information about assigning disc and track titles.

### To read the loaded disc titles and store them in PowerTouch:

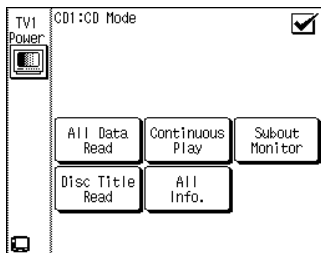
1. Touch  (HOME1) on the Quick Access menu.
2. Touch  (CD1).
3. Touch . This accesses the disc mode commands:









4. If you haven't already done so on the CD changer, touch . This reads all of the disc and track title information into the CD changer's memory.
5. Set PowerTouch down so that its IR transmitter window is aiming at the receiver's IR transmitter window. Select . Do not move PowerTouch while it is reading data.

This process may take some time, depending on how many CDs you have loaded. When the IR light on the receiver goes out, the receiver is done sending the information to PowerTouch, and you may move PowerTouch again. PowerTouch's memory now contains the disc titles of every CD in the changer with title information.

6. Touch  to return to the CD controls.

## How Do I Operate Devices?



**To read the loaded track titles and store them in PowerTouch:**

1. Make sure you have followed the previous instructions to read disc data.
2. Touch  (HOME1) on Quick Access menu.
3. Touch .
4. Touch . This accesses the disc mode commands.
5. If you haven't already done so on the CD changer, touch . This reads all of the disc and track title information into the CD changer's memory. Touch  to return to the CD controls.
6. Select the disc you want to play and touch  to open the track controls.
7. Set PowerTouch down so that its IR transmitter window is aiming at the receiver's IR transmitter window. Touch . Do not move PowerTouch while it is reading data.  
This process may take some time, depending on how many CDs you have loaded. You will see the track titles on the PowerTouch when it is finished reading data.
8. Touch  to return to the CD controls.

**Entering Disc and Track Titles**



You can also use PowerTouch to enter disc or track titles, if they are not already stored on the changer. The titles you add are stored in memory on both PowerTouch and the changer.

**To enter disc or track titles:**



1. Touch  (HOME1) on the Quick Access menu.
2. Touch .
3. Stop playing a CD. (if it is playing)



## How Do I Operate Devices?

4. Touch  or . This accesses the appropriate control commands.

If you pressed , you will be entering track titles for the currently selected disc.

5. Touch the disc or track name you want to change. See “How Do I Enter Text” on page 8 for more information on changing names.
6. Press .
7. Repeat steps 5 and 6 for each title you want to store.
8. Touch  to return to the disc or track controls. Touch it again to return to the CD controls.

## NOTES



If you rearrange or add new CDs to the changer, you will need to repeat both the disc and track read process. Otherwise, disc information is stored in PowerTouch permanently.

The track title information is not stored permanently in PowerTouch. Each time you select a CD to play you have to download its track title information.







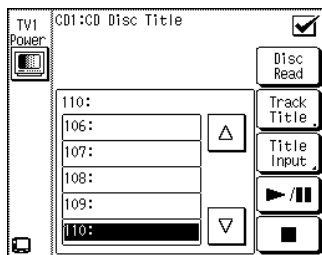

Title reading by PowerTouch is not possible for the following models.

Model: CD-2280M and CD-2260M.

### To play discs and tracks by title:



1. Touch  (HOME1) on the Quick Access menu.
2. Touch .
3. Touch . This accesses the disc commands:



4. Titles of all discs in the changer are displayed in numerical order.
5. Use the up  or down arrow  to scroll through the discs numerically, then touch the disc title you want to play.
6. If you want to play the disc from the beginning, touch .
7. (Optional) Touch . The track titles for that disc are displayed in numerical order.
8. If you want to play the disc starting from a particular track, use the up  or down arrow  to scroll through the track titles, then touch the track title.
9. When you've highlighted the track you want to begin playing, touch .
10. Touch  to return to the CD controls.

## SingleCD or Carrousel CD Player

### To operate SingleCD or Carrousel CD Player:

1. Touch  (HOME1) on the Quick Access menu.
2. Touch . This accesses the CD controls:

An example of Single CD  
(Kenwood system connection)

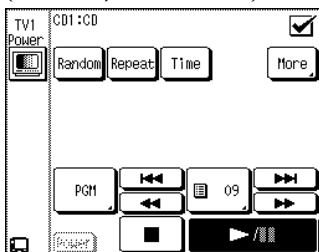

An example of Single CD  
(without system connection)

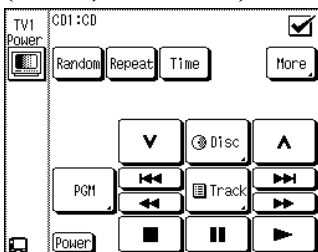

An example of Carrousel CD  
(Kenwood system connection)

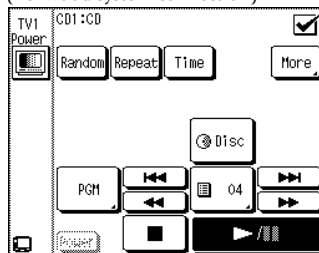

An example of Carrousel CD  
(without system connection)

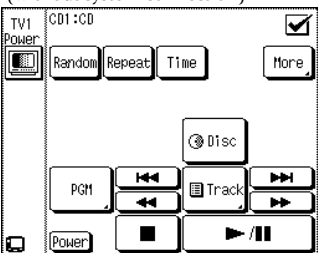



3. Use this screen as your CD player remote. The available buttons may vary depending on the setup code you assigned to this icon.

Touch  (more) to access any customized commands you have taught PowerTouch for this device and to access this device's macros. Touch the command or macro name to use it. (See "Operation on the More menu" on page 69 of this manual.)

For more information on teaching commands to PowerTouch, see "To Customize the PowerTouch Screen" on page 43 of the *Connections and Setup Guide*. For more information on device macros, see "How Do I Perform Several Actions at Once?" on page 76 of this manual.

## CD-R Recorder

To operate CD-R Recorder:

1. Touch  (HOME1) on the Quick Access menu.
2. Touch .

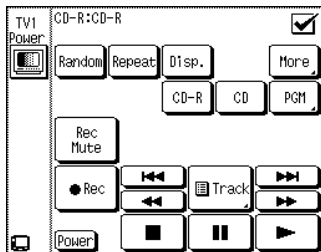

This accesses the CD-R Recorder controls:



3. Use this screen as your CD-R Recorder player remote. The available buttons may vary depending on the setup code you assigned to this icon.

## MD Recorder

### To operate MD Recorder:

1. Touch  (HOME1) on the Quick Access menu.
2. Touch . This accesses the MD recorder controls:

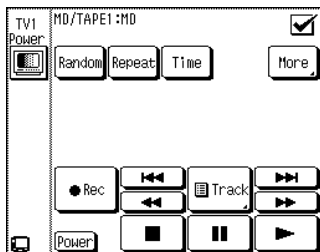

3. Use this screen as your MD recorder remote. The available buttons may vary depending on the setup code you assigned to this icon.









Touch  (more) to access any customized commands you have taught PowerTouch for this device and to access this device's macros. Touch the command or macro name to use it. (See "Operation on the More menu" on page 69 of this manual.)

For more information on teaching commands to PowerTouch, see "To Customize the PowerTouch Screen" on page 43 of the *Connections and Setup Guide*. For more information on device macros, see "How Do I Perform Several Actions at Once?" on page 76 of this manual.

## Entering Disc and Track Titles:



If you have Kenwood MD-2070, you can also use PowerTouch to enter disc or track titles.

### To enter disc or track titles:

1. Touch  (HOME1) on the main or Quick Access menu.
2. Touch .
3. Stop playing an MD. (if it is playing)
4. Touch .
5. See "How Do I Enter Text ?" on page 8 and enter a title.
6. Touch .
7. While watching the MD recorder's display, use  or  on the Mini Disc Title menu to select where you want to enter the title to (either disc title or track title). If you want to enter a track title, choose the track number you want to assign a name for.
8. Press .
9. Press  to return to MD controls.

## Tape Deck

### To operate Tape Deck:

1. Touch  (HOME1) on the Quick Access menu.
2. Touch . This accesses the tape deck controls:

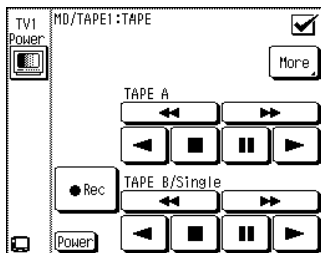

3. Use this screen as your tape deck remote. The available buttons may vary depending on the setup code you assigned to this icon.



Touch  (more) to access any customized commands you have taught PowerTouch for this device and to access this device's macros. Touch the command or macro name to use it. (See "Operation on the More menu" on page 69 of this manual.)

For more information on teaching commands to PowerTouch, see "To Customize the PowerTouch Screen" on page 43 of the *Connections and Setup Guide*. For more information on device macros, see "How Do I Perform Several Actions at Once?" on page 76 of this manual.

See your tape deck instruction manual for more information.

## Turntable



### To operate a turntable/record player:

1. Touch  (HOME1) on the Quick Access menu.
2. Touch  to set the turntable as the speaker source. You will remain at the HOME1 menu.
3. Play your records as normal. Please note that you cannot control the turntable with PowerTouch; you must still operate the turntable manually.





## Tuner

### To tune in to a radio station:

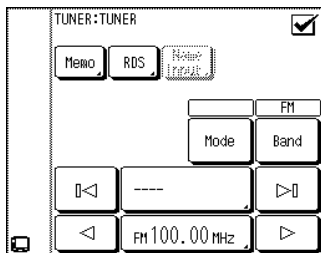





1. Touch  (HOME1) on the Quick Access menu.
2. Touch . This accesses the tuner commands:





### 3. Tune in the station.

- Touch  to change bands.
- Touch  to switch from Auto tuning to Manual tuning or Manual tuning to Auto tuning. Select Manual if you experience interference due to weak radio signals. (Stations are received in mono during manual tuning.)

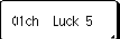

In Auto tuning mode, the stereo mode is activated automatically when a stereo station is tuned in (FM band only).

- Touch the left  or right arrow  to tune in a station.
- Touch  and enter the broadcast frequency using the 10key pad. (e.g.; To select FM 87.5 MHz, enter 8, 7, 5, 0 and )
- Select the left  or right end arrow  to cycle through any stations stored in memory.

## How Do I Operate Devices?

- Touch  to open the stored stations list. Touch a storage button and touch  to tune that station.

For more information on storing stations in memory, see “Storing Radio Stations in Memory (optional)” on page 41 of the *Connections and Setup Guide*.

- While Zone B is selected, only  and  can be operated.

4. Touch  (HOME1) on Quick Access menu to return to the HOME1 menu.

RDS (Radio Data System) : RDS is a system where radio stations transmit digital data for FM broadcasts along with the broadcast signal. Tuners and receivers designed for RDS reception can extract the data from the broadcast signal for use with various functions such as automatic display of the station name.

**RDS Functions help you:**



- Search for programs of a specific type using Program Type Identification Search (PTY search).
- Search for a station automatically when you select the station name. (PS Read)
- View information about a station:
  - the station name
  - any text data transmitted by the station
- Automatically select stations providing RDS and FM broadcasting and store them in the preset memory (up to 40 stations can be preset). For more information about storing stations, see “Storing Radio Stations in Memory (optional)” on page 41 of the *Connections and Setup Guide*.







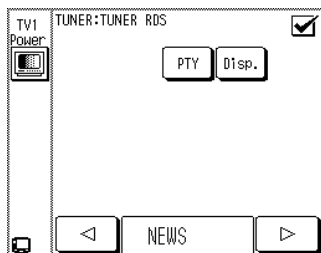

**NOTES**

Before using RDS functions, be sure to perform “Storing RDS Stations Automatically” on page 41 of the *Connections and Setup Guide*.

**To search for a specific type of music or radio program:**

1. Touch  (HOME1) on the Quick Access menu.
2. Touch .
3. Touch  at the top of the screen. This accesses RDS commands:



4. Touch .
5. While  is highlighted, select the program type you want using the following methods:
  - Select the left () or right arrow () to cycle through the program types until the type you want appears. The program types cycle in the order shown in the table below.
6. Touch 
  - If the tuner cannot find the program type you want, **“NO PROGRAM”** appears on the receiver display. The display returns to its original screen after several seconds.
  - If the tuner locates a station playing the program type you want, reception begins. The display changes to show the station name.

To change to a different program type, repeat Steps 4 through 6 above.

To cancel the program search, touch  during the PTY search.

Program Type Name	Receiver Display
News	NEWS
Information	INFORM
Sports	SPORTS
Talk	TALK
Rock	ROCK
Classic Rock	CLS ROCK
Adult Hits	ADLT HIT
Soft Rock	SOFT RCK
Top 40	TOP 40
Country	COUNTRY
Oldies	OLDIES
Soft	SOFT
Nostalgia	NOSTALGA
Jazz	JAZZ
Classical	CLASSICL
Rhythm and Blues	R & B
Soft Rhythm and Blues	SOFT R & B
Foreign Language	LANGUAGE
Religious Music	REL MUSC
Religious Talk	REL TALK
Personality	PERSNLTY
Public	PUBLIC
College	COLLEGE
Weather	WEATHER

## TV

### To operate a standard TV:

1. Touch  (HOME2) on the Quick Access menu.
2. Touch the TV icon button to which you assigned the TV. This accesses the TV controls:

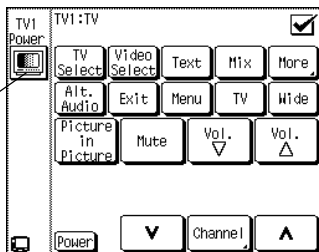

When the TV source is set for TV1, The Power control icons for TV1 will be displayed in the same position of all of the Device control screens, allowing you to switch the TV On and Off.

3. Use this screen as your TV remote. The available buttons may vary depending on the setup code you assigned to this icon.

Touch  (more) to access any customized commands you have taught PowerTouch for this device and to access this device's macros. Touch the command or macro name to use it. (See "Operation on the More menu" on page 69 of this manual.)

For more information on teaching commands to PowerTouch, see "To Customize the PowerTouch Screen" on page 43 of the *Connections and Setup Guide*. For more information on device macros, see "How Do I Perform Several Actions at Once?" on page 76 of this manual.

### To operate satellite TV:

1. Touch  (HOME2) on the Quick Access menu.
2. Press the Video icon button to which you assigned the satellite TV receiver. This accesses the satellite controls:

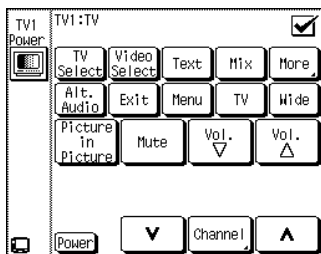

3. Use one of these screens as your satellite TV remote (depending on the service you receive). The available buttons may vary depending on the setup code you assigned to this icon.

Touch  (more) to access any customized commands you have taught PowerTouch for this device and to access this device's macros. Touch the command or macro name to use it. (See "Operation on the More menu" on page 69 of this manual.)

For more information on teaching commands to PowerTouch, see "To Customize the PowerTouch Screen" on page 43 of the *Connections and Setup Guide*. For more information on device macros, see "How Do I Perform Several Actions at Once?" on page 76 of this manual.

### To operate DSS or tuner:

1. Touch  (HOME2) on the Quick Access menu.
2. Press the Video icon button to which you assigned the satellite TV receiver. This accesses the satellite controls:

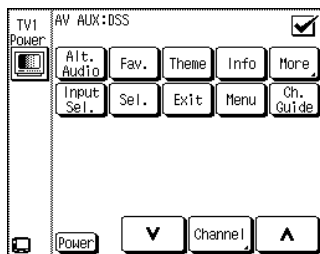

3. Use one of these screens as your satellite TV remote (depending on the service you receive). The available buttons may vary depending on the setup code you assigned to this icon.

Touch  (more) to access any customized commands you have taught PowerTouch for this device and to access this device's macros. Touch the command or macro name to use it. (See "Operation on the More menu" on page 69 of this manual.)

For more information on teaching commands to PowerTouch, see "To Customize the PowerTouch Screen" on page 43 of the *Connections and Setup Guide*. For more information on device macros, see "How Do I Perform Several Actions at Once?" on page 76 of this manual.



### To operate cable TV:

1. Touch  (HOME2) on the Quick Access menu.
2. Touch the TV or input icon button to which you assigned the cable TV tuner. This accesses the cable TV controls:

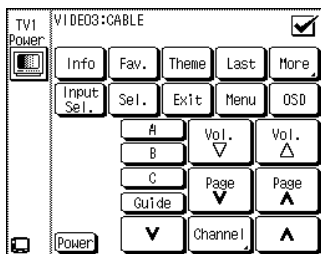

3. Use this screen as your cable TV remote. The available buttons may vary depending on the setup code you assigned to this icon.

Touch  (more) to access any customized commands you have taught PowerTouch for this device and to access this device's macros. Touch the command or macro name to use it. (See "Operation on the More menu" on page 69 of this manual.)

For more information on teaching commands to PowerTouch, see "To Customize the PowerTouch Screen" on page 43 of the *Connections and Setup Guide*. For more information on device macros, see "How Do I Perform Several Actions at Once?" on page 76 of this manual.

## VCR/PVR

### To operate the VCR/PVR:

1. Touch  (HOME2) on the Quick Access menu.
2. Touch the Video icon to which you assigned the VCR or PVR (personal video recorder). This accesses the VCR controls:

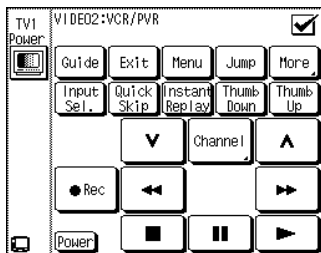

3. Use this screen as your VCR/PVR remote. The available buttons may vary depending on the setup code you assigned to this icon.

Touch  (more) to access any customized commands you have taught PowerTouch for this device and to access this device's macros. Touch the command or macro name to use it. (See "Operation on the More menu" on page 69 of this manual.)

For more information on teaching commands to PowerTouch, see "To Customize the PowerTouch Screen" on page 43 of the *Connections and Setup Guide*. For more information on device macros, see "How Do I Perform Several Actions at Once?" on page 76 of this manual.

## DVD Player

### To operate DVD Player:

1. Touch  (HOME2) on the Quick Access menu.
2. Select the icon you assigned to your DVD player. This accesses the DVD controls:

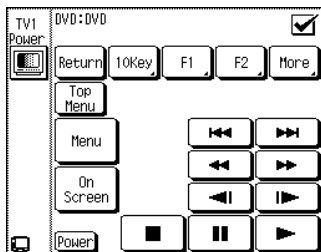

3. Use this screen as your DVD player remote. The available buttons may vary depending on the setup code you assigned to this icon.

Touch  (more) to access any customized commands you have taught PowerTouch for this device and to access this device's macros. Touch the command or macro name to use it. (See "Operation on the More menu" on page 69 of this manual.)

For more information on teaching commands to PowerTouch, see "To Customize the PowerTouch Screen" on page 43 of the *Connections and Setup Guide*. For more information on device macros, see "How Do I Perform Several Actions at Once?" on page 76 of this manual.

If you are listening to a DVD AUDIO music disc, you will need to switch the input from Digital Input to Analog 6ch Input. For more information on switching input, see "To set the Input mode manually" on page 23.

## Laser Disc Player

### To operate a laser disc player:

1. Touch  (HOME2) on the Quick Access menu.
2. Select the icon you assigned to the laser disc player. This accesses the laser disc controls:

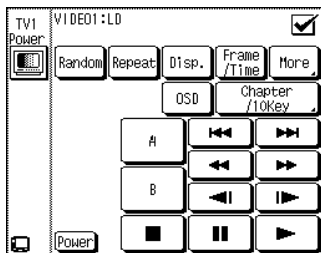

3. Use this screen as your laser disc player remote. The available buttons may vary depending on the setup code you assigned to this icon.

Touch  (more) to access any customized commands you have taught PowerTouch for this device and to access this device's macros. Touch the command or macro name to use it. (See "Operation on the More menu" on page 69 of this manual.)

For more information on teaching commands to PowerTouch, see "To Customize the PowerTouch Screen" on page 43 of the *Connections and Setup Guide*. For more information on device macros, see "How Do I Perform Several Actions at Once?" on page 76 of this manual.

## Operation on the More menu

The More menu can be opened from device control screen set for **CD1, MD/TAPE1, CD-R, VIDEO1, VIDEO2, VIDEO3, VIDEO4, DVD, TV1 or TV2**. The following figure shows an example of More menu:

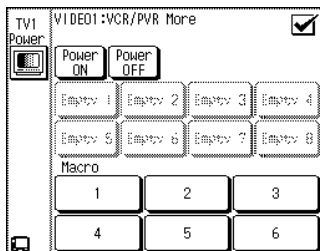

The eight buttons on the middle of the screen (Empty 1 to Empty 8 by default) are buttons with the learning capability. To use them, you should program the desired functions in them using the customization function. For more information on teaching commands to PowerTouch, see “To Customize the PowerTouch Screen” on page43 of the *Connections and Setup Guide*.

The Macro function makes it possible to record a device control procedure in each of the six Macro buttons (numbered 1 to 6 by default) at the bottom of the screen.

### How to use the Power ON or Power OFF button :

When you want to record a device power ON or OFF step in a macro, use the Power ON or Power OFF button in this menu.

When the macro is executed with recording of the operation of this button, PowerTouch checks whether power is currently On or Off and performs the power On or Off operation accordingly.

### The receiver should be ON to use the Macro function.

For more information on device macros, see “How Do I Perform Several Actions at Once?” on page 65 of this manual. After 5 seconds, the display of the set listen mode returns to the previous display.

The buttons which are not set by the learning or macro functions are grayed out and cannot be selected.

## How Do I Record (Edit Mode)?

PowerTouch provides a simple yet powerful editing procedure that lets you quickly and easily specify the source and destination devices.

To record:

1. Touch  (edit) on the Quick Access menu to open the Edit menu:

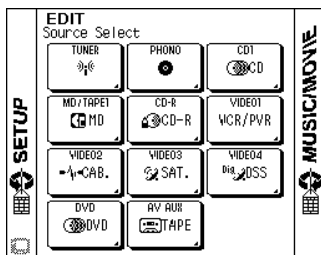



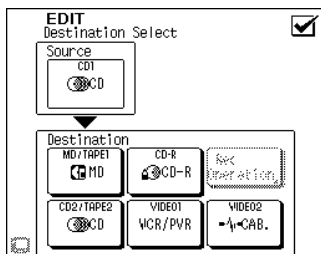

2. Touch a source device. This will be the device you are recording from, like a DVD or CD player. PowerTouch displays the destinations able to record from that source:



## How Do I Record (Edit Mode)?

3. Select the recording destination device and touch . PowerTouch displays the control screen for the destination device.

The  (Source) and  (Destination) are displayed on the left side of the control screen.

Each touch of the  or  switches between the source device control screen and the destination device control screen.

4. Touch the record control on the destination device, then switch to the source device and touch the play control.
5. Touch any Quick Access button to change to that menu.

For more information on recording with any connected device, see the device's instruction manual.



- If you're recording from a digital source, any action other than adjusting the volume may cause the sound to "clip" on the recording.
- You cannot record from the component you are using to record. For example, if you're recording on a VCR connected to the VIDEO 1 jacks, select a source other than Video 1.
- If your source is a camcorder or other video unit, refer to the instruction manual for the particular unit you're recording from.

### Digital to Digital Recording:

The PCM digital signal input through any DIGITAL IN jack is output digitally at the digital jack. For more information on this connection, see "Connecting Your MD Recorder or Primary Tape Deck" on page 20 of the *Connections and Setup Guide*.

Dolby Digital and DTS signals cannot be recorded.

### Digital to Analog Recording:

While home VCRs can record only two channels of audio, the receiver is capable of "down-mixing" the multi-channel audio of Dolby Digital, DTS or MPEG into stereo sound. Down-mixing is available by setting the Digital Rec mode to "REC MODE: AUTO" or "REC MODE: MANUAL".

How Do I Record (Edit Mode)?

Digital Rec mode:

Digital signals include a variety of signals such as the Dolby Digital, DTS and PCM signals.

When **REC MODE** is set to **AUTO**, digital input signals are automatically converted into analog stereo signals.

When **REC MODE** is set to **MANUAL**, only a specific signal among the digital signals can be converted into analog stereo signals.

When **REC MODE** is switched to **MANUAL** in the middle of reproduction of a digital audio program, only the digital signal of the type being reproduced will be converted into analog stereo signals.

When **REC MODE** is switched to **MANUAL** while no source is played, only the PCM signal will be converted into analog stereo signals.

To set the Digital Rec mode:

1. Touch the  Src. (Src.) or  Det. (Det.) so that  Src. (Src.) is reversed.
2. Select  Auto (digital rec. auto) or  Manual (digital rec. Manual).
3. When  Auto (digital rec. auto) or  Manual (digital rec. Manual) is selected, the receiver displays "REC MODE: AUTO" or "REC MODE: MANUAL".

It is not possible to recording monitor a digital source signal onto the device connected to the **CD2/TAPE2 MONITOR** input.



When a source recorded by down-mixing a multi-channel source is played back in the Dolby Pro Logic mode, the audio can be reproduced in 4-channel surround sound.





How Do I Adjust PowerTouch's Display?

## How Do I Adjust PowerTouch's Display?

### How Do I See PowerTouch in the Dark?

You can use your PowerTouch in the dark. When you turn on the back light, your PowerTouch screen will light up, making navigation easier if you need to operate PowerTouch in dim or nonexistent light.

To use PowerTouch in the dark, press  (**BACKLIGHT**).

To turn off the light and return to normal display, press  (**BACK-LIGHT**) again.

Backlight is automatically turned off when PowerTouch goes to "sleep"—you will need to turn it on again when you reactivate PowerTouch.



Keep the Back Light turned off during normal use to maximize the life of your batteries.

How Do I Adjust PowerTouch's Display?

### How Do I See PowerTouch's Screen More Clearly?

You can also adjust the contrast to suit your viewing angle.

To adjust the contrast:

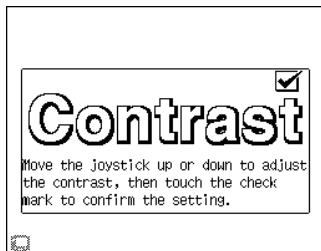

1. Press  (**CONTRAST**) until "**Contrast**" message appears on the screen:



2. While this message is displayed, move the joystick up or down to increase or decrease the contrast until you are satisfied.
3. Touch  to save the contrast setting and return to the control screen.

### How Do I Turn the Beeping On or Off?

PowerTouch emits beeps under various circumstances (for example, to confirm your entry). You can turn these sounds off if you don't want to hear them. To turn the beeps off:

1. Touch  (setup) on the Quick Access menu.
2. Touch  once to turn off beeping. Touch it again to turn beeping back on.

## Using PowerTouch to Dim or Brighten the Receiver's Front Panel



1. Touch  (Setup) on the Quick Access menu:



2. Touch  to make the receiver display illumination dim and less noticeable. It is also possible to disable some indicators (THX, DTS, D.R.I.V.E., DOLBY DIGITAL, MPEG, HDCD and Infrared remote transmitter indicator) on the receiver. Each touch of the FL Dimmer button switches the above as shown below:

- |     |                |                     |
|-----|----------------|---------------------|
| ➤ ① | Display/bright | Indicators/enabled  |
| ➤ ② | Display/dim    | Indicators/enabled  |
| ➤ ③ | Display/dim    | Indicators/disabled |

## Changing the Front Panel Display Mode

1. Touch  (Setup) on the Quick Access menu.
2. Touch .
  - A: Connected Device                      Input Mode
  - DVD :**    **AUTO**
  - B: Input Terminal                              Connected Device
  - VIDEO4 :**    **DVD**
  - C: Listen Mode
  - DOLBY DIGITAL**

"Input Mode" is displayed only when a selector with digital input is selected.

When the input selector is **PHONO** or **TUNER**, the connected device and listen mode are displayed alternately.

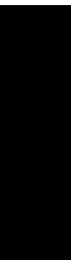





## Creating Macros

PowerTouch provides a simple way to create macros:

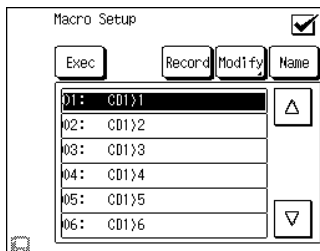
1. Think about the sequence of events you want to set up. You may even want to note down which devices should turn on first and how much time you think should pass between each step.

2. Touch  (Setup) on the Quick Access menu then touch .



3. Figure out what device you will be using when you want to run the macro and select a macro line associated with that device.
4. Touch . Enter a name for the macro. See “How Do I Enter Text?” on page 8 for more information on entering names.
5. Touch  to save the name in the Macro.
6. Touch  to record the Macro.
7. Perform the control operations of the devices in the order you want to record them.
8. Touch the  icon to complete the macro recording.

## Modifying a macro

1. Touch  (Setup) on the Quick Access menu then touch .

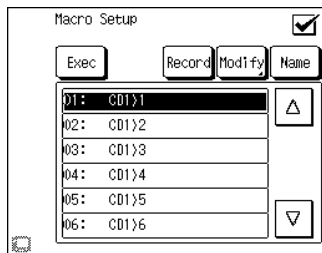

2. Select the macro line you want to modify.
3. Touch .

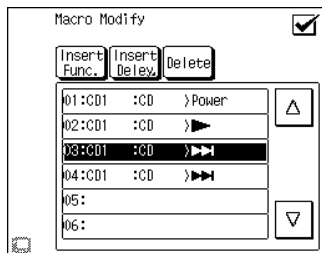

(Optional) To delete a function:

- a. Touch a macro function line you want to delete.
- b. Verify that this is the correct function. Touch .

(Optional) To insert a function:

- a. Touch a macro function line where you want to insert a function, then touch .

The function line will be inserted before the selected line.

- b. Touch a device, then touch an available function.

How Do I Perform Several Actions at Once?

4. Touch a device, then touch an available function.

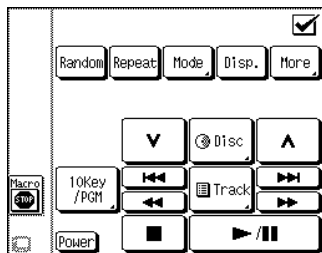

PowerTouch modify the function then returns you to the Macro Device menu.

5. Touch  to return to the Macro Function menu.
6. If some of the functions did not occur, you need to insert delay before these functions.

**To insert a delay (which is stored on its own line as a separate action):**

1. Touch the device line whose function did not occur.

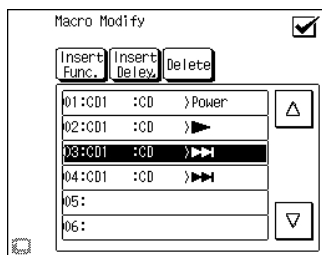

2. Touch .
3. Touch a delay time and touch . PowerTouch inserts the delay then returns you to the Macro Function menu.
4. Repeat step "1." through step "3." for other functions.
5. Touch  to return to the Setup Macro menu.
6. Touch a Quick Access button to return to the Home1 or Home2 menu.

## Using Macros

Once you have defined macros, you can use them directly from the basic menus (Home1, Home2) for one-touch operation of several devices.



The VR-5900 has "Perfect Macro" capability. This senses if video devices connected via the composite jacks, or video monitors with an optional power sensing device attached are on or off, and will ensure that the macro works properly.

Perfect Macro is available only with devices connected to the composite video jacks.

For example, you create a Video On macro where PowerTouch turns the receiver and all of your video devices on. If your TV is already on when you run the macro, Perfect Macro will keep it on.

For more information about using a TV power sensing device, see Chapter Four of the *Connections and Setup Guide*.

There are two ways to use the macros you defined

- from the Macro Summary menu, which displays all the available macros
- from the More screen for each device, which displays the macros associated with that device

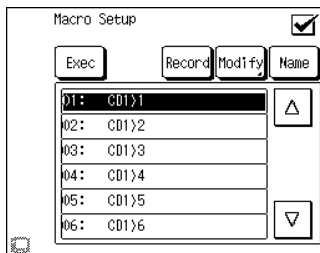

### To run a macro from the Macro Summary menu:

1. Touch  (Macro) on the Home1 menu or the Home2 menu to access the Macro menu:





How Do I Perform Several Actions at Once?

2. Touch a macro line. If the macro you want is not displayed, use the up  or down arrow  to scroll through the list until you see it.
3. Touch  to return to the previous menu.

**To run a macro from a device's "More" screen:**

1. Follow the steps under the device name in this chapter to access the controls for that device.
2. Touch More button.
3. Choose the macro from the list on the **under section** of the screen.

How Do I Control Home Automation Equipment?

## How Do I Control Home Automation Equipment?

Your new PowerTouch comes pre-programmed with codes to control home automation products manufactured by X-10, Lutron, and Makita. These products enable you to use PowerTouch to dim lights, close or open drapes, and operate non-audio/video equipment. You can even control home automation equipment as part of a macro. See “Creating Macros” on page 66 for more information.

PowerTouch’s control feature works using built-in screens specially designed to emulate the operation of X-10, Lutron, or Makita equipment remotes. These features require no setup to work with the compatible products listed.

Simply aim PowerTouch at the device you want to control, then touch the icon buttons and settings for the tasks you want to perform. Do **not** aim PowerTouch at your Kenwood receiver—none of the home automation devices are connected to it.



### Relay control

The devices connected to the RELAY CONTROL connectors on the rear of the receiver can be switched ON/OFF directly from PowerTouch.

### To switch on or switch off the RELAY CONTROL output using PowerTouch

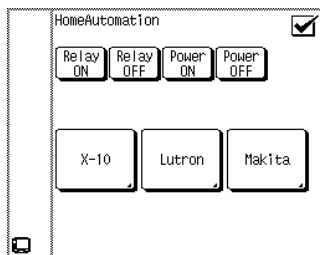
1. Access either the Home1 or Home2 menu and touch  to open the Home Automation menu:



2. Touch  to relay on or touch  to relay off.

## X-10 Home Automation

Using an X-10 Home Automation System, you can operate various items in your home with just a few buttons on your PowerTouch. Dimming lights and turning any non-audio/video equipment on or off is an easy task with X-10. All that is required is an X-10 IR converter and X-10 lamp control modules, which are sold separately.

For more information, see the manual for the particular device you want to control.

### To run your X-10 Home Automation System using PowerTouch:

1. Access either the Home1 or Home2 menu and touch  to open the Home Automation menu:

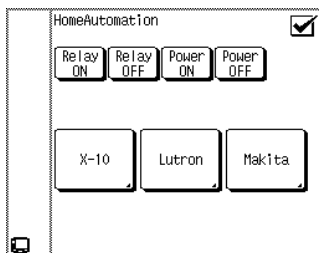

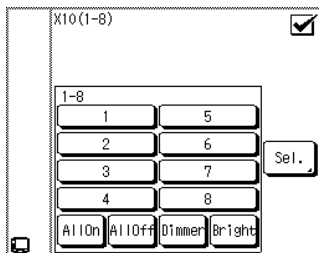

2. Touch  to access the X-10 commands:



3. Touch the numbered button that corresponds to the X-10 module you want to control. For more information, see your X-10 manual.

## How Do I Control Home Automation Equipment?

-  brightens lamp modules.
-  dims lamp modules.
-  means Select. Use this button to move back and forth between this group of buttons and the next eight buttons (9-16) on PowerTouch.

To change the name of a button, refer to "To Customize the PowerTouch Screen" on page 45 of the *Connection and Setup Guide*.

4. Touch  to return to the Home Automation menu.
5. Touch any Quick Access menu to change to that menu.

The X-10 IR-543 Converter is compatible with your PowerTouch. Contact X-10 at [www.x-10.com](http://www.x-10.com), or at [X10@x10.com](mailto:X10@x10.com). In addition, Radio Shack also sells a compatible converter (product number RSU 10037703).

## Lutron

Your PowerTouch can dim or brighten indoor lighting using the Lutron Spacer System or Lutron GRAFIK Eye devices, which are sold separately.

For more information, see your Lutron manual.

### To operate your Lutron controls using PowerTouch:

1. Access either the Home1 or Home2 menu and touch  to open the Home Automation menu.

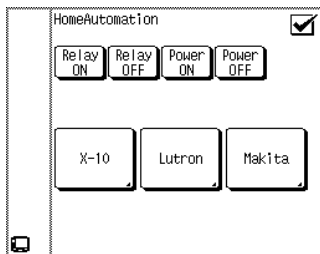

2. Touch  to access Lutron commands. Touch  to access either the Spacer (shown) or GRAFIK Eye control screens, depending on which system you use.

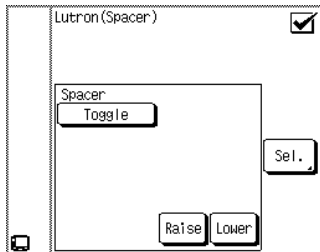

3. Use PowerTouch's screen as your Lutron remote. Refer to your Lutron manual for more information on these commands.

To change the name of a button, refer to "To Customize the PowerTouch Screen" on page 43 of the *Connection and Setup Guide*.

How Do I Control Home Automation Equipment?

4. Touch  to return to the Home Automation menu.
5. Touch any Quick Access menu to change to that menu.

Lutron models SP-HT-WH, GRX-IT, and GRX-8IT are compatible with your PowerTouch. Contact Lutron at:

Lutron Electronics Co., Inc.  
7200 Suter Road  
Coopersburg, PA 18036-1299  
800-523-9466  
[www.lutron.com](http://www.lutron.com)

### **Makita**

You can use your PowerTouch to open drapes or blinds in your home. Your PowerTouch completely replaces these Makita Automatic Drapery Opener System remotes:

- ZZRC10
- ZZRC20
- ZZRC30
- ZZRC60

For more information, see your Makita manual for the particular device you want to control.

## To operate your Makita device using PowerTouch:

1. Access either the Home1 or Home2 menu and touch  to open the Home Automation menu:

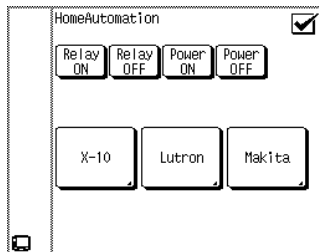

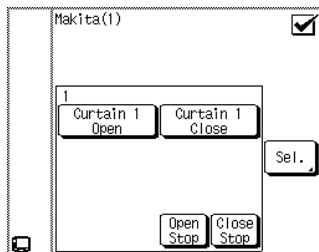

2. Touch  to access the Makita controls:



3. Use this screen as your Makita remote. If you want to control more than 1 Makita device, touch  to cycle through the additional screens. You can control up to 6 Makita devices. Refer to your Makita manual for more information on these commands.

To change the name of a button, refer to "To Customize the PowerTouch Screen" on page 43 of the *Connection and Setup Guide*.

4. Touch  to return to the Home Automation menu.
5. Touch any Quick Access menu to change to that menu.

To include a new curtain device (up to 6) touch .

How Do I Control Home Automation Equipment?

For more information, contact Makita at:

Makita USA Inc.  
14930 Northam Street  
La Mirada, CA, 90638-5753  
800-851-0537 (telephone)  
714-522-8194 (facsimile)  
Makitaapd@aol.com

The products and companies listed previously are not owned by or affiliated with Kenwood in any way. Please contact these companies directly for further information or to find a retailer near you.

## Accessories Control

PowerTouch includes 8 additional buttons for controlling virtually any device that accepts IR codes. You can use these buttons to control these devices in two possible ways:

- You can teach the preset IR code to the device.
- You can teach the device's IR code to PowerTouch.

Regardless of whether you teach the accessory PowerTouch's code or teach PowerTouch the accessory's code, these commands can also be included in PowerTouch's Macros. See "Creating Macros" on page 66 for more information.

### To teach one of PowerTouch's preset IR codes to a device:

1. Access either the Home1 or Home2 menu and touch  to open the Accessories menu:

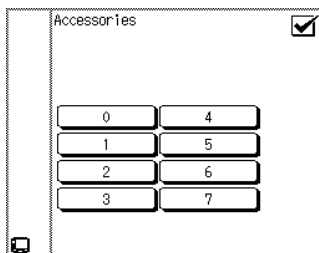



How Do I Control Home Automation Equipment?

2. See the device's manual for specific information about programming it with PowerTouch's accessory codes.
3. Touch a button. This button will control the accessory once you are done. If the button is already assigned to another accessory, the new assignment will overwrite the old one.

To change the name of a button, refer to "To Customize the PowerTouch Screen" on page 43 of the *Connection and Setup Guide*.

### To operate devices assigned to the accessory codes:

1. Access either the Home1 or Home2 menu and touch  to open the Accessories menu:

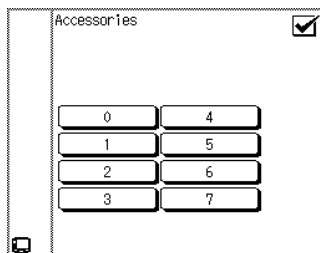

2. Touch the button corresponding to the code that you taught PowerTouch for the device you want to control.
3. Touch a Quick Access menu button to return to the Home1 or Home2 menu.

## Chapter Three: Using PowerTouch in Multiple Zones

The VR-5900 offers dual-zone output and control, which enables you to use a single receiver to control devices and speakers for 2 zones. Due to its advanced features and controls, you can listen to music in one zone while a movie plays in the other!

Depending on your tastes and budget, you can set up one of the following “sound scenarios” to make full use of the VR-5900’s capabilities:

**No additional amplifier for Zone B:** You can use the VR-5900’s Speaker B output for Zone B. This allows you to listen to full surround sound in Zone A only, or in stereo in Zone A when Zone B is active. The sound in Zone B will always be in stereo.

**Stereo amplifier for Zone B:** You use an additional stereo amplifier for Zone B (connected to the VR-5900’s Second Zone Preouts). This allows you to hear full surround sound in Zone A even if you are also listening in Zone B. The sound in Zone B will always be in stereo.

This chapter covers only multiple-zone operation of the VR-5900. See Chapter Two for general operating instructions.

## How Do I Switch Control Modes?



You can use PowerTouch to operate your receiver and source devices from 2 different zones. To do so, you need to switch control modes to control the devices from each zone.

To make operations from Zone B easier, we recommend that you purchase a second PowerTouch. That way you can leave one PowerTouch in Zone A that is always set up for Zone A operation, and another PowerTouch in Zone B that is always set up for Zone B operation.



### NOTES

Some system control features are not available when the PowerTouch is set up for multi-zone control.

To switch control modes for Zone A or Zone B:

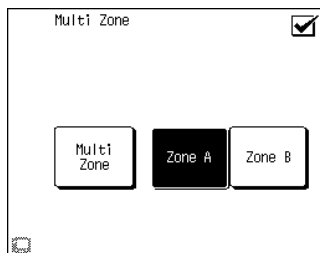
1. Touch  (setup) on the Quick Access menu to access the Setup menu.
2. Touch  to access multi-zone commands:



3. Touch  to highlight it.
4. Each touch   switches Zone A and Zone B alternately. The buttons which can be controlled currently are indicated by highlighting.

- Zone A controls devices connected for Zone A.
- Zone B controls devices connected for Zone B.

How Do I Switch Control Modes?

5. Touch  to return to the Setup menu.

If you buy a second PowerTouch, set one to Zone A (and keep it there) and one to Zone B (and keep it there).

### **Why Don't I See All My Devices?**

Your Kenwood PowerTouch displays icon buttons for each of the devices in your home audio-video system that you have identified to the PowerTouch. If you have not identified a device to the PowerTouch, its icon button will appear blank (the buttons will be there, but it will not contain an icon). For more information on identifying devices to the PowerTouch, see "How Do I Identify Devices?" on page 40 of the *Connection and Setup Guide*.

When you switch zones, only devices you can control in that zone will show up as icons on PowerTouch.



Devices connected via digital jacks only cannot be listened to in Zone B. We recommend that you connect the analog jacks of all devices. You must use the composite video connections. Only video sources connected with composite connectors can be viewed in the second zone.

## How Do I Operate Devices?

General instructions for operating any device are given under “How Do I Operate Devices?” on page 35. Some operations, however, are a little different depending on the zone you are in. The following section discusses how devices may operate differently in different zones.

### Operating Devices in Zone A

To select the speakers for Zone A, press the button for Speakers–A on the front panel of the receiver.

To set up PowerTouch to control Zone A devices, follow the instructions under “How Do I Switch Control Modes?” on page 91.

To control a second CD player from Zone A, use  , unless you are using a Kenwood 200-Disc CD Changer (see below).

Kenwood CD-3280M or CD-2280M 200-Disc CD Changers are specifically designed to work with the VR-5900 in a dual-zone environment. Since they contain two CD players, one can play in Zone A while the other is playing simultaneously in Zone B. Use CD1 to control the changer for Zone A and CD2 to control the changer for Zone B.

### Operating Devices in Zone B

If you are using the receiver’s Speaker B outputs to power the speakers in Zone B, press the button for **SPEAKERS B** on the front panel of the receiver to activate the speakers in Zone B. The Listen Mode in Zone A will automatically switch to stereo when you turn **SPEAKERS B** on.

To set up PowerTouch to control Zone B devices, follow the instructions under “How Do I Switch Control Modes?” on page 91.

# Chapter Four: Troubleshooting

Troubleshooting is how you determine what part of a complex system (like a home theater system) is at fault when the system isn't working how you think it should. When you troubleshoot a system, you diagnose a problem by examining and eliminating possible causes until there's only one left. Troubleshooting is easiest when you start with the most obvious, most common, and most likely and work from there.

Diagnosing your own problems can save you time and aggravation—the better you understand how to troubleshoot and adjust your own system, the less time you have to:

- spend on the phone with a customer service representative
- do without your receiver because it's "in the shop"

There are some basic steps to good troubleshooting:

## **1. Verify the exact conditions when the problem occurs.**

This is the most important step in troubleshooting. Whether you fix it yourself or have to describe it to a technician, you are much more likely to really solve the problem if you know the exact circumstances surrounding the problem. For example, if you don't hear anything through the speakers, it's useful to know if it only happens when you are listening to CDs. Knowing that eliminates the speakers themselves as part of the problem. The more you know about when a problem occurs, the more likely it is that you or the technician can solve it.

## **2. Check each part of the signal's path from source (such as a CD player) to speaker.**

You may also want to test the assumptions you made in step 1: maybe you haven't listened to your MD recorder in a while— is there no sound from it as well? This step will really help narrow down the possible causes. Test all your connected devices and eliminate the ones where the problem doesn't occur. When you're done with this step, you'll probably have found the problem.

**3. Go over all device connections slowly and methodically. Double-check the settings on your remote.**

Wrong or loose connections are the most likely cause of the most common home entertainment problem: no sound. Use the *Connection and Setup Guide* to double-check your connections for each device. This is especially important with VCRs, tape decks, MD recorders, and equalizers, where it's very easy to swap the "play" and "record" connections.

You should also check your PowerTouch settings carefully. Did you set the input to the correct device? (you can also check the front panel of the receiver) Are you trying to listen to an analog source using a digital connection?

**4. Cables (especially old ones) go bad more frequently than devices do.**

Always suspect the cable before its device. For one thing, it's easier to test: simply swap the cable with one connected to a device you know is working. If the problem device works now, it was the cable. You can generally purchase new cables at most home electronics stores, or via the Internet.

**5. User error is more likely than device failure.**

You probably don't want to hear this, but it's true. Use this manual to go over the steps to operate the receiver. Refer to the other devices' manuals as well.

**6. Instruction manuals are your friend.**

A good rule of thumb is to check the manual when something doesn't work how you expected it to. If you read the manual before calling the store or taking the device back, you may find the solution to your problem much more quickly.

The rest of this chapter presents some common problems, grouped by type, and the steps you can take to resolve them.

## Sound

### **I don't hear any sound at all**

Check that:

- The volume is set at the proper level. See "Adjusting the Volume" on page 11 of this manual.
- Mute is OFF. If the **MUTE** indicator on the front of the receiver is blinking, **MUTE** is ON. See "Muting Sound" on page 15 of this manual.
- The proper input (e.g., CD player, Tuner, etc.) has been selected on the PowerTouch. See "How Do I Operate Devices?" on page 29 of this manual.
- The proper zone has been selected. See "How Do I Switch Control Modes?" on page 91 of this manual.
- The **CD2/Tape2 MONITOR** input has not been selected. (If it has, the **CD2/Tape2 MONITOR** indicator on the receiver's front panel will be lit). See "What's on the Front Panel of Your Kenwood Audio - Video Receiver?" on page 2 of this manual.
- The input mode matches the input signal (e.g., analog vs. digital) that has been set. See "To set the Input mode manually" on page 23 of this manual.
- The correct Input Mode (e.g., FULL AUTO) has been set for the digital input. See "Input Modes" on page 22.
- The correct speakers have been activated. See "Turning the Speakers On" on page 10 of this manual.

### **Audio is not output only when a 96k fs compatible disc is played.**

- The optical cable may be bent. Use a new optical cable.
- Check that the optical cable connector is connected properly.
- Certain DVD player models inhibit digital output. Use analog cables with such a DVD player.

### **I can't hear sound from one or more of the speakers, or the sound is abnormally low**

Check that:

- All of the speaker wires are connected tightly, not short circuited. See Chapter One of the *Connections and Setup Guide*.



**The 96k fs indicator does not light while a 96k fs compatible disc is being played.**

- The indicator will not light unless the DVD player is properly set.
- All of the speakers have been activated in the Setup Speakers menu. See Chapter Two of the *Connections and Setup Guide*.
- The individual speaker levels are set properly. See Chapter Two of the *Connections and Setup Guide*.
- The **CD2/TAPE2 MONITOR** input has not been selected. (If it has, the **CD2/TAPE2 MONITOR** indicator on the receiver's front panel will be lit). See "What's on the Front Panel of Your Kenwood Audio - Video Receiver?" on page 2 of this manual.
- The correct speakers have been activated. See "Turning the Speakers On" on page 10 of this manual.
- The correct listen mode has been selected. See "What Are Listen Modes?" on page 18 of this manual.

**I can't hear sound from my surround or center speakers**

Check that:

- The proper surround play mode (Dolby Pro Logic, Dolby Pro Logic II, DSP, MPEG, DTS, DTS-ES or Dolby Digital) has been selected. See "What are Listen Modes?" on page 18 of this manual.
- All of the speaker wires are connected tightly. See Chapter One of the *Connections and Setup Guide*.

**I can hear sound only from the center speaker when Dolby Pro Logic is selected**

Check that the program (e.g., TV show, radio station, VCR tape) is in stereo. Programs in mono play only through the center speaker when the receiver is in the Dolby Pro Logic listen mode.

**A DTS-ES encoded source is played but it is not decoded in DTS-ES.**

Check that:

- DTS-ES decoding in playback is not available if THX Surround EX is set to On, THX Surround EX Auto or THX is On. Set THX to Off.

**A Dolby Digital Surround EX-encoded source is played with THX Surround EX set to “Auto”, but the source is not reproduced in 6.1-channel audio.**

Check that:

- Some encoded sources (discs) do not contain the recording of the encoding identification signal. To reproduce such sources in 6.1-channel audio, set THX Surround EX to ON.

**Sound from one (or more) of my devices is abnormally loud or soft.**



Adjust the analog input level for that device:

1. Select the icon for the device. For CD1, DVD, MD/Tape, CD-R, VIDEO2, VIDEO3, and VIDEO4, also select the Input Analog icon.
2. Touch  (setup) on the main menu.

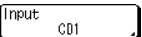

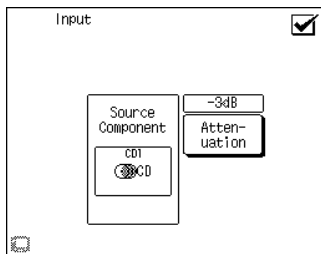
3. Select .



4. Touch . Every time you select the button the volume will cycle between 0dB, -3dB, -6dB and back up to 0dB. Select the level that best matches that of the other sources.
5. Touch  to return to the Setup menu.

### **I can't hear any sound in Zone B**

Check that:

- The volume in Zone B is turned up. See "How Do I Switch Control Modes?" on page 91 of this manual.
- The Zone B speakers are turned on if using Speaker B outputs for Zone B (as opposed to Second Zone Pre Outs). See "Turning the Speakers On" on page 10 of this manual.
- The source is connected via an analog jack set (digital inputs are not sent to Zone B). See Chapter One of the *Connections and Setup Guide*.
- Multiple Zones is activated.

### **I can't hear sound from some of my laser discs**

Check that the disc contains a digital soundtrack (the disc's cover will bear a "digital sound" logo). Some older laser discs contain only analog soundtracks. If the disc does not have a digital soundtrack, change the input mode to Analog. See "To set the Input mode manually:" on page 23 of this manual and also read the manual of your laser disc player.

### **There wasn't any sound recorded on tapes made on my VCR or tape deck**

Check that:

- The audio cables are connected properly for the device.
- The source is connected via an analog jack set (digital inputs are not sent to Zone B). See Chapter One of the *Connections and Setup Guide*.
- Analog has been set as the input type. Digital inputs such as Dolby Digital, DTS or MPEG need to be downmixed into two channels for recording to analog media (such as VHS or audio tape). See "Digital to Analog Recording" on page 72.

**The initial sound is intermittent or non-existent when I start to play from a Dolby Digital, DTS, DTS-ES or MPEG source**

- Some DVD players simply have intermittent start-up sound.
- Check that the correct digital cable is being used. The cable must be a *digital* coaxial or optical cable. See Chapter One of the *Connections and Setup Guide*.

**With a Dolby Digital program or DTS program, the loud sounds aren't very loud and the quiet sounds aren't very quiet**

Check that volume extremes are not automatically being balanced. See "Midnight Theater Function" on page 16 of this manual.

**All I hear is loud static when I play DTS discs**

- Check that Digital has been set as the input type. DTS discs do not output analog sound. See "To Set Input Mode manually" on page 23.
- DTS discs can only be played in Zone A

**I hear a hum when I select the PHONO input**

Check that:

- The audio cables are connected securely to the Phono jack set. See Chapter One of the *Connections and Setup Guide*.
- The turntable is grounded on the receiver. See Chapter One of the *Connections and Setup Guide*.

**Audio is not output only when a 96 kfs compatible disc is played.**

- The optical cable may be bent. Distribute optical cables as straight as possible.
- Check that the optical cable connector is connected properly.
- Certain DVD player models or DVD discs inhibit digital output. Use analog cables with such a DVD player.

**Sound is intermittent**

Attach the provided protective cap to the unused OPTICAL inputs. If the light from a fluorescent lamp or direct sunlight enters through this connector, the played audio will be intermittent.

## Video

### **I can't see the program I'm playing on the TV**

#### **There wasn't any video output to my VCR when I recorded**

- Check that the video source and TV are connected via the same type of connectors. Component input signals cannot be transmitted via S-Video or composite connections. All Zone B inputs must be composite. S-Video is not supported in Zone B.
- Check that the correct video input on the TV is selected.
- Check that the video software you record does not have copy guard protection.

## PowerTouch

### **I don't see icons for all my devices**

You must identify devices for PowerTouch control for them to appear in the icon bar on PowerTouch. See Chapter Two of the *Connections and Setup Guide*.

### **I don't see icons for all the devices I set up**

Some of the device icons appear only when PowerTouch is set up to control Zone A and some appear only when PowerTouch is set up to control Zone B. See "Why Don't I See All My Devices?" on page 92 of this manual.

### **When I select a device icon, I don't see any commands**

- When you start PowerTouch for the very first time, all the possible icons appear. If you select any of them, there will be no commands in the command area. You must set up PowerTouch before you can begin controlling devices. See Chapter Two of the *Connections and Setup Guide*.
- Re-enter the setup code for the device. See Chapter Two of the *Connections and Setup Guide*.

### **My PowerTouch is slow to respond—sometimes I have to press buttons or select commands several times**

- If PowerTouch is in sleep mode (the screen is blank), the first button press "wakes it up". The second press performs the action.
- Your PowerTouch supports 2-way communication with the receiver. If the Two-way communication indicator on the front of the receiver is lit, PowerTouch is receiving information. It cannot transmit your new command until it is finished receiving information from the receiver.

### My PowerTouch is not responding

- Make sure you are within the operating range for PowerTouch. See "How is PowerTouch Powered?" on page 5 of this manual.
- Replace the batteries. See Chapter Two of the *Connections and Setup Guide*.
- If you're using an IR receiver, make sure it is connected properly and turned on. See Chapter Four of the *Connections and Setup Guide*.
- Check the contrast of the PowerTouch's screen is adjusted properly. See "How Do I See PowerTouch's Screen More Clearly?" on page 74.

### My PowerTouch is beeping. What does that mean?

The following table includes information about PowerTouch beeps:

Number	Tone	Meaning
1	high	Confirms your most recent button push or touch
1	low	Indicates that your most recent button push or touch could not be performed
2	high	Confirms learning or copying
2	low	Indicates that learning or copying was not successful

### PowerTouch does not "learn" new commands or functions.

- Check that the distance between PowerTouch and the device's remote is properly set. Do not place the device's remote right against PowerTouch.
- Check whether the PowerTouch is too close to the receiver, a TV, high-frequency fluorescent lighting or other electrical appliance.
- "Learning" may be not carried out with some devices' remote.

### I want to clear all the items in PowerTouch and make it to the factory-set default condition.

- While pressing and holding the **CONFIRM** and **VOLUME DOWN** button, use the stylus to press the **RESET** button at the bottom of the battery case.

## Receiver/Tuner

### **My receiver won't turn on and the STANDBY indicator is flashing**

Your receiver is in the “protection” mode.

Check that:

- The speaker system's impedance is not too low. See Chapter One of the *Connections and Setup Guide*.
- The speaker wires are not short-circuited. Test the wires as follows to find the shorted wire and replace it:
  - ① Turn off the receiver, disconnect the positive and negative speaker wires of the RIGHT FRONT speaker from the receiver, and turn the receiver back on.
  - ② If the STANDBY indicator stops flashing, replace this wire.
  - ③ If the STANDBY indicator does not stop flashing, turn off the receiver, reconnect the speaker wires, and repeat the first step for the next speaker.
  - ④ Continue until you have isolated and replaced the shorted wire.
  - ⑤ See Chapter One of the *Connections and Setup Guide*.

If none of the above solutions work, reset the microprocessor:

1. Turn the receiver off. (The Power button is OFF position.)
2. Press ON/STANDBY button while pressing and holding the Power button.

The following settings are cleared:

- The device set as input (Tuner is selected by default)—see “How Do I Operate Devices?” on page 35 of this manual.
- The volume setting (-48dB is selected by default)—see “Adjusting the Volume” on page 11 of this manual.
- The tuner's receiving band (FM is selected by default)— see “Tuner” on page 57 of this manual.
- The tuner's frequency (87.5MHz is selected by default)— see “Tuner” on page 57 of this manual
- The tuner's preset memory—you will need to reset your stored radio stations (see Chapter Two of the *Connections and Setup Guide*)

- The surround setting—see “What are Listen Modes?” on page 18 of this manual.
- The speaker settings—you will need to reset your speaker settings ( see Chapter Two of the *Connections and Setup Guide*)

Reset the cleared settings before operating the receiver again.

**The sound is distorted, and the CLIP indicator on the receiver’s front panel flashes red continually, or stays red for more than 1 second at a time**

Lower the analog input level for the source device you’re listening to. (Setting the proper input level eliminates distortion that occurs if a source device’s output level is too high. When this happens, the front panel CLIP indicator will flash red continually or remain red for periods of 1 second or longer. Occasional brief flashing of the CLIP indicator is okay).



1. Touch  (setup) on the main menu.

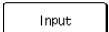

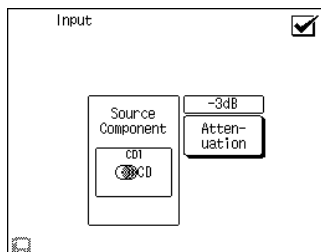
2. Select .





3. Touch . Every time you select the button the volume will cycle between 0dB, -3dB, -6dB and back up to 0dB.
4. While the source component is playing, reduce the Input Level to -3dB. If the CLIP indicator still flashes frequently or remains lit for 1 second or longer, reduce the Input Level again to -6dB.
5. Touch  to return to the Setup menu.

### **I can't access any RDS (Radio Data System) functions (for U.K. only)**

- Confirm that the radio station is broadcasting RDS.
- Make sure you use the Auto Memory function to store RDS stations in memory. See "Storing RDS Stations Automatically" on page 41 of the *Connections and Setup Guide*.

### **I can't receive a radio station**

Check that:

- The appropriate antenna is connected. See Chapter One of the *Connections and Setup Guide*.
- The broadcast band is correct. See "Tuner" on page 57 of this manual.
- The tuner is set to the correct frequency. See "Tuner" on page 57 of this manual.

### **I'm getting a lot of static/interference**

- Check whether the receiver or antenna is too close to a TV or other electrical appliance.
- Adjust the antenna for best reception.
- If you live in an area with weak FM signals, consider a rooftop or an amplified FM antenna (available at any home electronics store).

### **When I press a button to tune to a preset station, the receiver does not respond**

Check whether:

- The receiver has been unplugged for more than three days. If it has, your settings were cleared from the receiver's memory. See "My receiver won't turn on and the STANDBY indicator is flashing" on page 103 of this manual.
- The Tuner input is selected. See "Tuner" on page 57 of this manual.

**Macro is not running as I programmed.**

- Because PowerTouch can only transmit one command at a time, stagger the timings of the various macro settings so that the commands are given at different times.
- On or Off command for audio devices may not work correctly if they are not Kenwood components connected via system control cables.
- Depending on the video signals of the connected video devices, TV power sensing may not work correctly.

# Index

## Numerics

- 200-Disc CD Changer
  - introductory information ..... 39
  - operating ..... 40
  - operating in multiple rooms . 88
  - playing CDs ..... 40
  - reading and storing disc titles .. 41
  - warning during PowerTouch load time ..... 42

## A

- accessories
  - accessing codes with PowerTouch ..... 80
  - controlling miscellaneous devices ..... 84
- adjusting PowerTouch display screen ..... 62
- analog input, switching ..... 22
- AV AUX front panel ..... 2

## B

- balancing volume extremes ..... 16
- batteries, maximizing life ..... 62

## C

- CD player
  - operating ..... 40, 45
  - operating from room A ..... 88
- CD2/TAPE 2 MONITOR indicator light ..... 2
- CD-R Recorder
  - operating ..... 47
- changing front panel display ..... 64
- confirm button ..... 3, 7
- custom macros
  - creating ..... 66
  - operating ..... 70

## D

- devices
  - checklist ..... 31, 39
  - identifying to Powertouch ..... 29
  - operating ..... 29, 88
- devices controlling from each room .. 88
- Digital Signal Processor (DSP)
  - effects ..... 24
- digital to analog recording ..... 61
- digital to digital recording ..... 61
- dimming receiver front panel ..... 64
- display panel ..... 2
- display screen
  - adjusting ..... 62
  - devices displayed ..... 4
- Dolby Digital ..... 18
- DTS ..... 18
- DVD player
  - operating ..... 37
  - switching input ..... 22

## H

- headphones
  - jack ..... 2
  - using ..... 28
- home-theater sound ..... 16

## I

- icons
  - not appearing on powerTouch ..... 87
  - identifying components ..... 29, 97
- Input Analog mode ..... 21
- IR indicator and transmitters ..... 2
- items on PowerTouch ..... 3

**J**

- joystick
  - moving around on PowerTouch ..... 7
  - on PowerTouch ..... 3

**L**

- laser disc player, operating ..... 38
- listen modes
  - defined ..... 17
  - Dolby 3 Stereo ..... 17
  - Dolby Digital ..... 18
  - Dolby Pro Logic ..... 17
  - DSP (Digital Signal Processing) ..... 17
  - DTS (Digital Theater System) ..... 18
  - MPEG ..... 18
  - setting manually ..... 23
  - stereo ..... 17
- Lutron
  - contact information ..... 77
  - operating ..... 74

**M**

- macros
  - creating ..... 66
  - using ..... 70
- Makita
  - contact information ..... 80
  - operating ..... 77
- MD recorder, operating ..... 48
- MPEG ..... 18
- moving around ..... 7
- multiple rooms
  - operating devices ..... 88
  - sound scenarios ..... 85
  - switching control modes ..... 86
- mute button ..... 3
- muting sound ..... 15

**O**

- operating
  - devices ..... 29
  - home automation
    - equipment ..... 72
  - macros ..... 70
  - range ..... 5

**P**

- Perfect Macro ..... 70
- Power On/Standby button ..... 2

**R**

- radio stations, ..... 52
- RDS (Radio Data System)
  - definition ..... 54
  - features ..... 54
  - searching for radio stations using PowerTouch ..... 55
- reading and storing CD titles ..... 42
- receiver
  - changing display mode ..... 64
  - dimming front panel ..... 64
  - items on front panel ..... 2
- recording ..... 59
- room A
  - operating CD player ..... 88
  - operating devices ..... 88
  - setting up PowerTouch ..... 86
  - sound scenarios ..... 85
  - speakers, operating ..... 10
  - speakers, selecting ..... 88
  - switching control modes ..... 86
- room B
  - operating devices ..... 88
  - setting up PowerTouch ..... 86
  - sound scenarios ..... 85
  - speakers, operating ..... 10, 88
  - switching control modes ..... 86

<b>S</b>	
satellite TV, operating .....	33
searching	
specific radio programs .....	55
setting	
DSP effects .....	25
listen mode manually .....	23
sound	
adjusting .....	10
scenarios in multiple rooms ..	85
speakers	
levels, adjusting .....	13
loudness, adjusting .....	11
selector keys on receiver .....	2
tone, adjusting .....	12
room A, operating .....	88
room B, operating .....	88
Surround Play, checking .....	19
surround sound	
listen modes .....	17
multiple rooms .....	85
switching	
to analog input .....	21
room control modes .....	86

<b>T</b>	
tape deck	
operating .....	50
tuner	
operating .....	52
turntable	
operating .....	51
TV	
operating .....	32

<b>U</b>	
using	
joystick to move around .....	7
macros .....	70
PowerTouch in multiple rooms .	85
PowerTouch in the dark .....	62
PowerTouch's interface .....	6

<b>V</b>	
VCR	
operating .....	36
volume	
adjusting .....	11
control knob .....	2

<b>X</b>	
X-10 Home Automation System	
contact information .....	74
operating .....	72

