

Poulan PRO®

ENGLISH



Please do not return unit to retailer.
Por favor, no devuelva el aparato al lugar de compra.
Veuillez ne pas retourner l'outil au détaillant.

1-800-554-6723

www.poulan-pro.com

Instruction Manual Manual de Instrucciones Manuel d'Instructions

PPB350

ESPAÑOL

For Occasional Use Only



DANGER:

Read and follow all Safety Rules and Operating Instructions before using this product. Failure to do so can result in serious injury.

PELIGRO:

Lea el manual de instrucciones y siga todas las advertencias e instrucciones de seguridad. El no hacerlo puede resultar en lesiones graves.

DANGER:

Lire le manuel d'instructions et bien respecter tous les avertissements et toutes les instructions de sécurité. Tout défaut de le faire pourrait entraîner des blessures graves.

Poulan PRO
1030 Stevens Creek Road
Augusta, GA 30907

FRANÇAIS

545117592

8/8/06

SAFETY RULES

WARNING: When using gardening appliances, basic safety precautions must always be followed to reduce the risk of fire and serious injury.

DANGER: This power tool can be dangerous! This unit can cause serious injury including amputation or blindness to the operator and others. The warnings and safety instructions in this manual must be followed to provide reasonable safety and efficiency in using the unit. The operator is responsible for following the warnings and instructions in this manual and on the unit. Read the entire instruction manual before assembling and using the unit! Restrict the use of this unit to persons who read, understand, and follow the warnings and instructions in this manual and on the unit. Never allow children to operate this unit.



INSTRUCTION MANUAL



SAFETY INFORMATION ON THE UNIT

DANGER: Blade can thrust violently away from material it does not cut. Blade thrust can cause amputation of arms or legs. Keep people and animals 50 feet (15 meters) away.



WARNING: Blade/trimmer line can throw objects violently. You and others can be blinded or injured. Wear safety glasses and leg protection.



- Always use:
- Hearing protection
 - Eye protection
 - Head protection

ALWAYS WEAR:

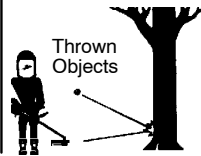

WARNING: Hazard zone for thrown objects. Blade/trimmer line can throw objects violently. Others can be blinded or injured. Keep people and animals 50 feet (15 meters) away.

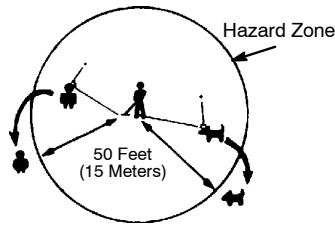

WARNING: Do not use trimmer head as a fastening device for the blade.



WARNING: The blade continues to spin after the throttle is released or, engine is turned off. The coasting blade can throw objects or seriously cut if accidentally touched. Stop the blade by contacting the right hand side of the coasting blade with material already cut.

Stop coasting blade by contact with cut material.

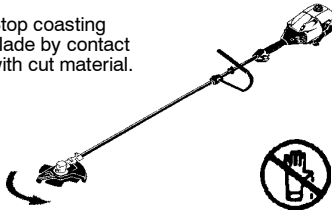

OPERATOR SAFETY

- Dress properly. Always wear safety glasses or similar eye protection when operating, or performing maintenance on your unit (safety glasses are available). Eye protection should be marked Z87.
- Always wear face or dust mask if operation is dusty.
- Always wear heavy, long pants, long sleeves, boots, and gloves. Wearing safety leg guards is recommended.
- Always wear foot protection. Do not go barefoot or wear sandals.
- Secure hair above shoulder length. Secure or remove loose clothing and jewelry or clothing with loosely hanging ties, straps, tassels, etc. They can be caught in moving parts.
- Being fully covered also helps protect you from debris and pieces of toxic plants thrown by spinning line/blade.
- Stay Alert. Do not operate unit when you are tired, ill, upset or under influence of alcohol, drugs, or medication. Watch what you are doing; use common sense.
- Wear hearing protection.

- Never start or run the engine inside a closed room or building. Breathing exhaust fumes can kill.
- Keep handles free of oil and fuel.
- Always use the handlebar and a properly adjusted shoulder strap with a blade (see ASSEMBLY).

UNIT/MAINTENANCE SAFETY

⚠ WARNING: Stop unit and disconnect the spark plug before performing maintenance (except carburetor adjustments).

- Look for and replace damaged or loose parts before each use. Look for and repair fuel leaks before use. Keep unit in good working condition.
- Throw away blades that are bent, warped, cracked, broken, or damaged in any other way. Replace trimmer head parts that are cracked, chipped, broken, or damaged in any other way before using the unit.
- Maintain unit according to recommended procedures. Keep blade sharp. Keep cutting line at the proper length.
- Use only 0.095" (2.4 mm) diameter Poulan PRO brand replacement line. Never use wire, rope, string, etc.
- Install required shield properly before using the unit. Use the metal shield for all metal blade use. Use the plastic shield for all line trimmer use.
- Use only specified blade or trimmer head; make sure it is properly installed and securely fastened.
- Never start engine with clutch shroud removed. The clutch can fly off and cause serious injury.
- Be sure blade or trimmer head stops turning when engine idles.
- Make carburetor adjustments with the lower end supported to prevent blade or trimmer line from contacting any object. Hold unit by hand; do not use the shoulder strap for support.
- Keep others away when making carburetor adjustments.
- Use only recommended Poulan PRO accessories and replacement parts.
- Have all maintenance and service not explained in this manual performed by your authorized service dealer.

FUEL SAFETY

- Mix and pour fuel outdoors.
- Keep away from sparks or flames.
- Use a container approved for fuel.
- Do not smoke or allow smoking near fuel or the unit or while using the unit.
- Avoid spilling fuel or oil. Wipe up all fuel spills before starting engine.
- Move at least 10 feet (3 meters) away from fueling site before starting engine.
- Stop engine and allow it to cool before removing fuel cap.
- Empty the fuel tank before storing or transporting the unit. Use up fuel left in the carburetor by starting the engine and letting it run until it stops.
- Store unit and fuel in area where fuel vapors cannot reach sparks or open flames from

water heaters, electric motors or switches, furnaces, etc.

- Always store gasoline in a container approved for flammable liquids.

CUTTING SAFETY

⚠ WARNING: Inspect the area to be cut before each use. Remove objects (rocks, broken glass, nails, wire, string, etc.) which can be thrown or become entangled in the blade or trimmer head.

- Keep others including children, animals, bystanders, and helpers at least 50 feet (15 meters) away. Stop engine immediately if you are approached.
- Always keep engine on the right-hand side of your body.
- Hold the unit firmly with both hands.
- Keep firm footing and balance. Do not over-reach.
- Keep blade or trimmer head below waist level. Do not raise engine above your waist.
- Keep all parts of your body away from blade, trimmer head, and muffler when engine is running. A hot muffler can cause serious burns.
- Cut from your left to your right. Cutting on right side of the shield will throw debris away from the operator.
- Use only in daylight or good artificial light.
- Use only for jobs explained in this manual.

TRANSPORTING AND STORAGE

- Stop the unit before carrying.
- Keep muffler away from your body.
- Allow the engine to cool and secure the unit before storing or transporting it in a vehicle.
- Empty the fuel tank before storing or transporting the unit. Use up fuel left in the carburetor by starting the engine and letting it run until it stops.
- Store unit so the blade or line limiter blade cannot accidentally cause injury. The unit can be hung by the shaft.
- Store unit out of reach of children.

SAFETY NOTICE: Exposure to vibrations through prolonged use of gasoline powered hand tools could cause blood vessel or nerve damage in the fingers, hands, and joints of people prone to circulation disorders or abnormal swellings. Prolonged use in cold weather has been linked to blood vessel damage in otherwise healthy people. If symptoms occur such as numbness, pain, loss of strength, change in skin color or texture, or loss of feeling in the fingers, hands, or joints, discontinue the use of this tool and seek medical attention. An anti-vibration system does not guarantee the avoidance of these problems. Users who operate power tools on a continual and regular basis must monitor closely their physical condition and the condition of this tool.

SPECIAL NOTICE: This unit is equipped with a temperature limiting muffler and spark arresting screen which meets the requirements of California Codes 4442 and 4443. All U.S. forest land and the states of California, Idaho, Maine, Minnesota, New Jersey, Oregon, and Washington require by law that many internal combustion engines be

equipped with a spark arresting screen. If you operate in a locale where such regulations exist, you are legally responsible for maintaining the operating condition of these parts. Failure to do so is a violation of the law. For normal

homeowner use, the muffler and spark arresting screen will not require any service. After 50 hours of use, we recommend that your muffler be serviced or replaced by your authorized service dealer.

ASSEMBLY

CARTON CONTENTS

Check carton contents against the following list:

- Brushcutter
- Cupped washer
- Large nut for installing blades
- Hex wrench
- Handlebar
- Bracket cover
- Bracket cover screws (2)
- Metal blade shield
- Blade shield screws (4)
- 4-point weed blade
- Plastic shield
- Wing nut (screwed onto plastic shield)
- Shoulder strap with warning
- Container of oil

⚠ WARNING: Always stop unit and disconnect spark plug before performing any assembly procedures.

⚠ WARNING: If received assembled, repeat all steps to ensure your unit is properly assembled and all fasteners are secure.

Examine parts for damage. Do not use damaged parts.

NOTE: If you need assistance or find parts missing or damaged, call 1-800-554-6723.

It is normal for the fuel filter to rattle in the empty fuel tank.

Finding fuel or oil residue on muffler is normal due to carburetor adjustments and testing done by the manufacturer.

TOOLS REQUIRED

- Hex wrench (provided)
- Adjustable wrench
- Phillips screwdriver

ATTACHING THE HANDLEBAR

⚠ DANGER: To avoid serious injury, the barrier portion of the handlebar must be installed as shown to provide a barrier between operator and the spinning blade.

1. Locate the decal on the handlebar. This decal includes an arrow. Position the handlebar with the mounting bracket at the end of the arrow.
2. Position the bracket cover over the handlebar. Again make sure the handlebar is at the end of the arrow.
3. Insert screws and hand tighten only. Be sure the handlebar is installed correctly; then, tighten each screw securely with the hex wrench.

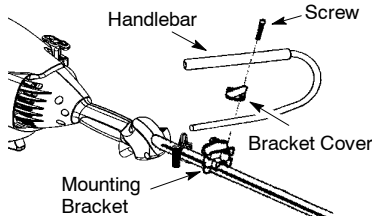

ASSEMBLY OF SHOULDER STRAP

⚠ WARNING: Proper shoulder strap and handlebar adjustments must be made with the engine completely stopped before using unit.

1. Insert your right arm and head through the shoulder strap and allow it to rest on your left shoulder. Make sure the danger sign is on your back and the hook is to the right side of your waist.

NOTE: A one-half twist is built in the shoulder strap to allow the strap to rest flat on the shoulder.

2. Adjust the strap, allowing the hook to be about 6 inches (15 cm) below the waist.
3. Fasten the strap hook to the clamp located between the trigger handle and the handlebar clamp base and lift the tool to the operating position.
4. Try on shoulder strap and adjust for fit and balance before starting the engine or beginning a cutting operation.

NOTE: It may be necessary to relocate the shoulder strap clamp on the shaft for proper balancing of unit.

TO RELOCATE SHOULDER STRAP CLAMP:

1. Loosen and remove both clamp screws.
2. Place the upper shoulder strap clamp over the shaft.
3. Position the lower shoulder strap clamp under the shaft and align the upper and lower clamp screw holes.

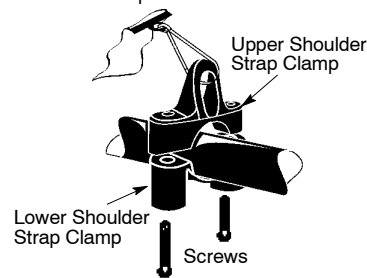

4. Insert two screws into the screw holes.
5. Secure shoulder strap clamp by tightening screws with a hex wrench.

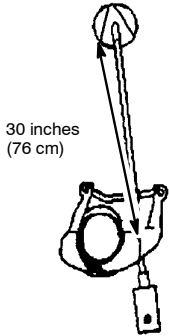
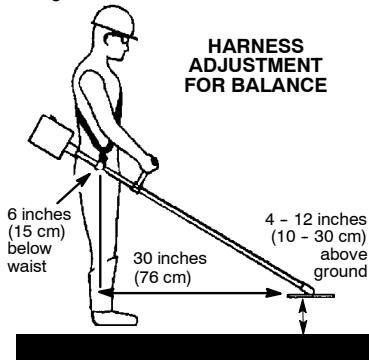

CONFIGURING YOUR UNIT

You can configure your unit using a cutting head for grass and light weeds, or a weed blade for cutting grass, weeds, and brush up to 1/2 inch (1 cm) in diameter. To assemble your unit, go to the section for the desired configuration and follow the instructions.

ASSEMBLY INFORMATION - TRIMMER HEAD

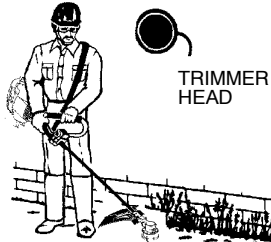

NOTE: Remove the blade and metal shield before attaching the plastic shield and trimmer head. To remove blade, align hole in the dust cup with the hole in the side of the gearbox by rotating the blade. Insert a small screwdriver into aligned holes. This will keep the shaft from turning while loosening the blade nut. Remove blade nut by turning clockwise. Remove the

screwdriver. Remove both washers and blade. To remove metal shield, loosen and remove the four mounting screws. See ATTACHING THE METAL SHIELD and INSTALLATION OF THE METAL BLADE for illustrations. Be sure to store all parts and instructions for future use.

ATTACHING THE PLASTIC SHIELD AND TRIMMER HEAD

WARNING: The shield must be properly installed. The shield provides partial protection to the operator and others from the risk of thrown objects, and is equipped with a line limiter blade which cuts excess line to the proper length. The line limiter blade (on underside of shield) is sharp and can cut you.

1. Remove wing nut from shield.
2. Insert bracket into slot on shield.
3. Pivot shield until bolt passes through hole in bracket.
4. Tighten the wing nut securely.

NOTE: If your unit has a plastic cover over the threads on the threaded shaft, remove the covering to expose the threads. Before installing the trimmer head, make sure the dust cup and retaining washer are positioned on the gearbox as shown below.

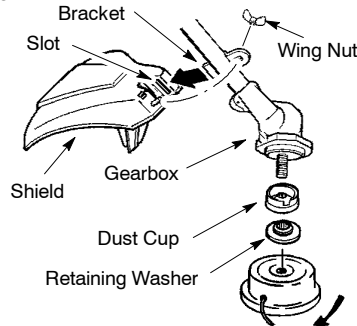

NOTE: Make sure all parts are properly installed as shown in the illustration before installing the trimmer head.

5. Align hole in the dust cup with the hole in the side of the gearbox by rotating the dust cup.
6. Insert a small screwdriver into aligned holes. This will keep the shaft from turning while tightening trimmer head.

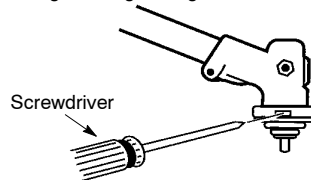

7. While holding the screwdriver in position, thread trimmer head onto the shaft in the direction shown on the decal (counterclockwise). Tighten until secure.

NOTE: The retaining washer must be positioned with the raised section facing toward the gearbox.

ASSEMBLY INFORMATION - WEED BLADE



NOTE: Remove the trimmer head and plastic shield before attaching the metal shield and installing the weed blade. To remove the trimmer head, align hole in the dust cup with the hole in the side of the gearbox by rotating the dust cup. Insert a small screwdriver into aligned holes. This will keep the shaft from turning while loosening the trimmer head. Remove the trimmer head by turning clockwise. Remove the screwdriver. To remove the plastic shield, loosen and remove wing nut. Pivot shield to release bracket from slot. See INSTALLATION OF THE CUTTING HEAD and ATTACHING THE PLASTIC SHIELD for illustrations. Be sure to store all parts and instructions for future use. Never use the trimmer head with the metal blade installed.

ATTACHING THE METAL SHIELD

WARNING: The metal shield must be properly installed on the tool anytime the tool is used with a blade. The forward tip of the metal shield helps to reduce the occurrence of blade thrust which can cause serious injury such as amputation to the operator or bystanders. Failure to install the shield in the position shown can result in serious injury to the operator. The length of the shield must be aligned with the length of the shaft.

1. Place the metal shield under the gearbox, and align the screw holes.

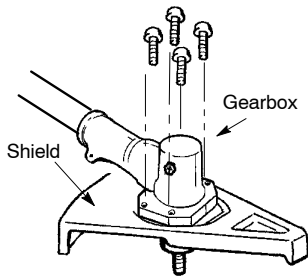

2. Insert and thread the 4 mounting screws through the holes of the gearbox and the metal shield. Tighten evenly and securely with the hex wrench provided.

INSTALLATION OF THE METAL BLADE

WARNING: Wear protective gloves when handling or performing maintenance on the blade to avoid injury. The blade is sharp and can cut you even when it is not moving.

WARNING: Do not use any blades, or fastening hardware other than the washers and nuts shown in the following illustrations. These parts must be provided by Poulan/Weed Eater and installed as shown below. Failure to use proper parts can cause the blade to fly off and seriously hurt you or others.

NOTE: The dust cup and retaining washer are located on the gearbox shaft and not in the parts bag. All other fasteners mentioned in the following assembly steps are in the parts bag.

1. Remove the retaining washer from the threaded shaft of the gearbox. Leave the dust cup on the shaft.
2. Install the blade and the retaining washer over the threaded shaft.
3. Make sure the raised part of the retaining washer is facing the gearbox and the raised area fits into the hole in the center of the blade.
4. Slide the blade and retaining washer onto the shaft of the gearbox.
5. Place the cupped washer onto the shaft. Make sure the cupped side of the washer is toward the blade.
6. Install the blade nut by threading onto the shaft counterclockwise.

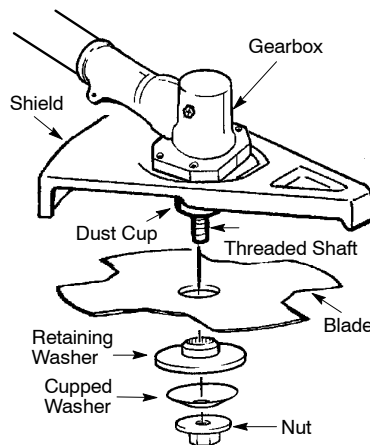

NOTE: Make sure all parts are in place as illustrated, and the blade is sandwiched between the dust cup and the retaining washer. There should be no space between the blade and the dust cup or the retaining washer.

7. Align hole in dust cup with hole in side of gearbox by rotating the blade.
8. Insert a small screwdriver into aligned holes. This will keep the shaft from turning while tightening the blade nut.

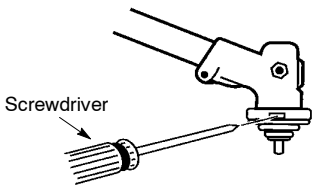

9. Tighten blade nut firmly with a wrench while holding screwdriver in position.
10. Remove the screwdriver.
11. Turn blade by hand. If the blade binds against the shield, or appears to be uneven, the blade is not centered, and you must re-install.

NOTE: To remove blade, insert screwdriver into aligned holes. Unthread the nut and remove parts. Be sure to store parts and instructions for future use.

OPERATION

KNOW YOUR UNIT

READ THIS INSTRUCTION MANUAL AND SAFETY RULES BEFORE OPERATING YOUR UNIT. Compare the illustrations with your unit to familiarize yourself with the location of the various controls and adjustments. Save this manual for future reference.

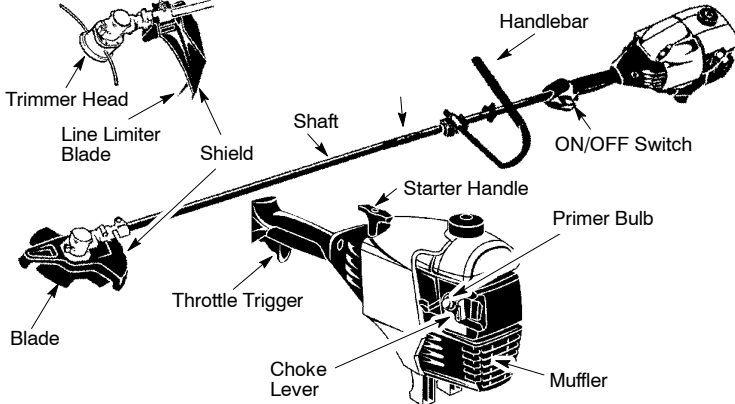

ON/OFF SWITCH

The ON/OFF switch is located on the trigger handle and is used to stop the engine. Move the switch to the OFF position to stop the engine.

PRIMER BULB

The PRIMER BULB removes air from the carburetor and fuel lines and fills them with fuel. This allows you to start the engine with fewer pulls on the starter rope. Activate the primer bulb by pressing it and allowing it to return to its original form.

CHOKE

The CHOKE helps to supply fuel to the engine to aid in cold starting. Activate the choke by moving the choke lever to the FULL CHOKE position. After the engine attempts to start, move the choke lever to the HALF CHOKE position. Once engine has started, move the choke lever to the OFF CHOKE position.

BEFORE STARTING ENGINE

WARNING: Be sure to read the fuel information in the safety rules before you begin. If you do not understand the safety rules, do not attempt to fuel your unit. Call 1-800-554-6723.

FUELING ENGINE

WARNING: Remove fuel cap slowly when refueling.



HELPFUL TIP
To obtain the correct oil mix ratio, pour 3.2 ounces of 2-cycle synthetic oil into one gallon of fresh gas.

This engine is certified to operate on unleaded gasoline. Before operation, gasoline must be mixed with a good quality synthetic 2-cycle air-cooled engine oil designed to be mixed at a ratio of 40:1. Poulan/WEED EATER brand synthetic oil is recommended. Mix gasoline and oil at a ratio of 40:1. A 40:1 ratio is obtained by mixing 3.2 ounces (95 ml) of oil with 1 gallon (4 liters) of unleaded gasoline. **DO NOT USE** automotive oil or marine oil. These oils will cause engine damage. When mixing fuel, follow instructions printed on container. Once oil is added to gasoline, shake container momentarily to assure that the fuel is thoroughly mixed. Always read and follow the safety rules relating to fuel before fueling your unit.

IMPORTANT

Experience indicates that alcohol blended fuels (called gasohol or using ethanol or methanol) can attract moisture which leads to separation and formation of acids during storage. Acidic gas can damage the fuel system of an engine while in storage. To avoid engine problems, empty the fuel system before storage for 30 days or longer. Drain the gas tank, start the engine and let it run until the fuel lines and carburetor are empty. Use fresh fuel next season. Never use engine or carburetor cleaner products in the fuel tank or permanent damage may occur. See the STORAGE section for additional information.

HOW TO STOP YOUR UNIT

- To stop the engine, move the ON/OFF switch to the OFF position.
- If engine does not stop, move choke lever to FULL CHOKE position.

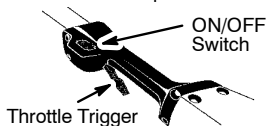

HOW TO START YOUR UNIT

WARNING: Avoid any contact with the muffler. A hot muffler can cause serious burns.



HELPFUL TIP

If your engine still does not start after following these instructions, please call 1-800-554-6723.

STARTING A COLD ENGINE (or a warm engine after running out of fuel)

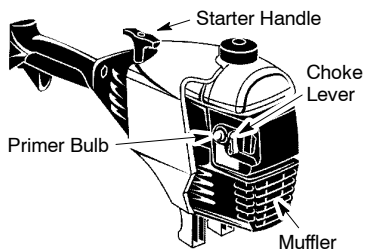

1. Set unit on a flat surface.
2. Move ON/OFF switch to the ON position.
3. Slowly press the primer bulb 6 times.
4. Move choke lever to FULL CHOKE by aligning lever with position shown on decal (see illustration below).

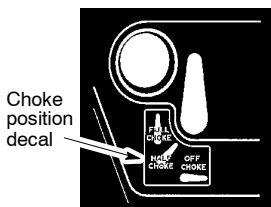

5. Squeeze the throttle trigger fully and hold through *all remaining steps*.
6. Pull starter rope handle sharply until engine sounds as if it is trying to start, but do not pull rope more than 6 times.
7. As soon as engine sounds as if it is trying to start, move choke lever to HALF CHOKE by aligning lever with position shown on decal (see illustration below).



8. Pull starter rope sharply until engine runs, but no more than 6 pulls. If the engine doesn't start after 6 pulls (at the HALF CHOKE position), move the choke lever to the FULL CHOKE position and press the primer bulb 6 times. Squeeze and hold the throttle trigger and pull the starter rope 2 more times. Move the choke lever to the HALF CHOKE position and pull the starter rope until the engine runs, but no more than 6 pulls. If the engine doesn't start, repeat procedure 2 additional times.

NOTE: If engine still doesn't start, it is probably flooded. Proceed to STARTING A FLOODED ENGINE.

9. Once the engine starts, allow it to run 10 seconds, then move the choke lever to OFF CHOKE by aligning lever with position shown on decal (see illustration below). Allow the unit to run for 30 more seconds at OFF CHOKE before releasing the throttle trigger.

NOTE: If engine dies with the choke lever in the OFF CHOKE position, move the choke lever to the HALF CHOKE position and pull the rope until engine runs, but no more than 6 pulls.

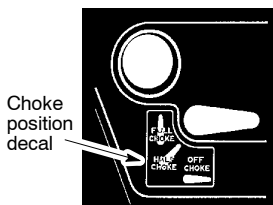

STARTING A WARM ENGINE

1. Move ON/OFF switch to the ON position.
2. Move the choke lever to the HALF CHOKE position.
3. Squeeze and hold the throttle trigger. Keep throttle trigger fully squeezed until the engine runs smoothly.
4. Pull starter rope sharply until engine runs, but no more than 5 pulls.
5. Allow engine to run 15 seconds, then move the choke lever to the OFF CHOKE position.

NOTE: If engine has not started, pull starter rope 5 more pulls. If engine still does not run, it is probably flooded.

STARTING A FLOODED ENGINE

Flooded engines can be started by placing the choke lever in the OFF CHOKE position; then, pull the rope to clear the engine of excess fuel. This could require pulling the starter handle many times depending on how badly the unit is flooded.

If the unit still doesn't start, refer to TROUBLESHOOTING TABLE or call 1-800-554-6723.

OPERATING INSTRUCTIONS

It is recommended that the engine not be operated for longer than 1 minute at full throttle.

OPERATING POSITION

ALWAYS WEAR:

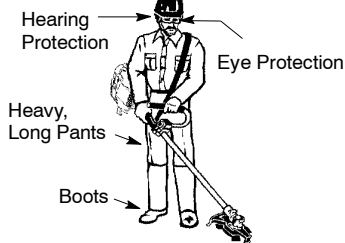

Cut from your left to your right.

When operating unit, clip shoulder strap onto clamp, stand as shown and check for the following:

- Wear hearing protection, eye protection, head protection and heavy clothing.
- Extend your left arm and hold handlebar grip with your left hand.
- Hold throttle grip with your right hand with finger on throttle trigger.
- Keep unit below waist level.
- Keep shoulder strap pad centered on your left shoulder and danger sign centered on your back.
- Maintain full weight of tool on your left shoulder.
- Without bending over, keep the blade or trimmer head near and parallel to the ground and not crowded into material being cut.

OPERATING INSTRUCTIONS FOR USE WITH TRIMMER HEAD

WARNING: Always wear eye protection. Never lean over the trimmer head. Rocks or debris can ricochet or be thrown into eyes and face and cause blindness or other serious injury.

Before trimming, bring engine to a speed sufficient to cut material to be trimmed.

Do not run the engine at a higher speed than necessary. The cutting line will cut efficiently when the engine is run at less than full throttle. At lower speeds, there is less engine noise and vibration. The cutting line will last longer and will be less likely to "weld" onto the spool.

Always release the throttle trigger and allow the engine to return to idle speed when not cutting.

To stop engine:

- Release the throttle trigger.
- Move the ON/OFF switch to the OFF position.

TRIMMER LINE ADVANCE

The trimmer line will advance approximately 2 inches (5 cm) each time the bottom of the trimmer head is tapped on the ground with the engine running at full throttle.

The most efficient line length is the maximum length allowed by the line limiter. Always keep the shield in place when the tool is being operated.

To advance line:

- Operate the engine at full throttle.
- Hold the trimmer head parallel to and above the grassy area.
- Tap the bottom of the trimmer head lightly on the ground one time. Approximately 2 inches (5 cm) of line will be advanced with each tap.

Always tap the trimmer head on a grassy area. Tapping on surfaces such as concrete or asphalt can cause excessive wear to the trimmer head. If the line is worn down to 2 inches (5 cm) or less, more than one tap will be required to obtain the most efficient line length.

WARNING: Use only 0.095" (2.4 mm) diameter line. Other sizes of line will not advance properly and can cause serious injury. Do not use other materials such as wire, string, rope, etc. Wire can break off during cutting and become a dangerous missile that can cause serious injury.

CUTTING METHODS

WARNING: Use minimum speed and do not crowd the line when cutting around hard objects (rock, gravel, fence posts, etc.), which can damage the trimmer head, become entangled in the line, or be thrown causing a serious hazard.

- The tip of the line does the cutting. You will achieve the best performance and minimum line wear by not crowding the line into the cutting area. The right and wrong ways are shown below.

Tip of the line does the cutting.



Right

Line crowded into work area.

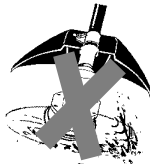

Wrong

- The line will easily remove grass and weeds from around walls, fences, trees and flower beds, but it also can cut the tender bark of trees or shrubs and scar fences.
- For trimming or scalping, use less than full throttle to increase line life and decrease head wear, especially:
 - During light duty cutting.
 - Near objects around which the line can wrap such as small posts, trees or fence wire.
- For mowing or sweeping, use full throttle for a good clean job.

TRIMMING - Hold the bottom of the trimmer head about 3 inches (8 cm) above the ground and at an angle. Allow only the tip of the line to make contact. Do not force trimmer line into work area.

Trimming

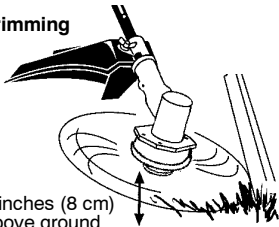

3 inches (8 cm) above ground

SCALPING - The scalping technique removes unwanted vegetation down to the ground. Hold the bottom of the trimmer head about 3 in. (8 cm) above the ground and at an angle. Allow the tip of the line to strike the ground around trees, posts, monuments, etc. This technique increases line wear.

Scalping

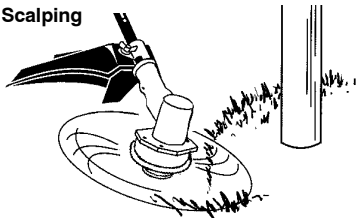

MOWING - Your trimmer is ideal for mowing in places conventional lawn mowers cannot reach. In the mowing position, keep the line parallel to the ground. Avoid pressing the head into the ground as this can scalp the ground and damage the tool.

Mowing

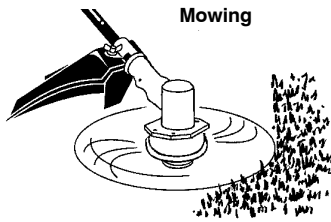

SWEEPING - The fanning action of the rotating line can be used to blow away loose debris from an area. Keep the line parallel to and above the area surface and swing the tool from side to side.

Sweeping



OPERATING INSTRUCTIONS FOR USE WITH WEED BLADE

- **Blade Thrust** is a reaction that only occurs when using a bladed unit. This reaction can cause serious injury such as amputation. Carefully study this section. It is important that you understand what causes blade thrust, how you can reduce the chance of its occurring, and how you can remain in control of unit if blade thrust occurs.
- **WHAT CAUSES BLADE THRUST - Blade Thrust** can occur when the spinning blade contacts an object that it does not cut. This contact causes the blade to stop for an instant and then suddenly move or "thrust" away from the object that was hit. The "thrusting" reaction can be violent enough to cause the operator to be propelled in any direction and lose control of the unit. The uncontrolled unit can cause serious injury if the blade contacts the operator or others.
- **WHEN BLADE THRUST OCCURS - Blade Thrust** can occur without warning if the blade snags, stalls, or binds. This is more likely to occur in areas where it is difficult to see the material being cut. By using the unit properly, the occurrence of blade thrust will be reduced and the operator will be less likely to lose control.



- Cut only grass, weeds, and woody brush up to 1/2 inch (1 cm) in diameter with the weed blade. Do not let the blade contact material it cannot cut such as stumps, rocks,

fences, metal, etc., or clusters of hard, woody brush having a diameter greater than 1/2 inch (1 cm).

- Keep the blade sharp. A dull blade is more likely to snag and thrust.
- Cut only at full throttle. The blade will have maximum cutting power and is less likely to bind or stall.
- "Feed" the blade deliberately and not too rapidly. The blade can thrust away if it is fed too rapidly.
- Cut only from your left to your right. Cutting on right side of the shield will throw debris away from the operator.
- Use the shoulder strap and keep a firm grip on the unit with both hands. A properly adjusted shoulder strap will support the weight of the unit, freeing your arms and hands to control and guide the cutting motion.
- Keep feet comfortably spread apart and braced for a possible sudden, rapid thrust of unit. Do not overreach. Keep firm footing and balance.
- Keep blade below waist level; it will be easier to maintain control of unit.
- Do not raise the engine above your waist as the blade can come dangerously close to your body.
- Do not swing unit with such force that you are in danger of losing your balance.

Bring the engine to cutting speed before entering the material to be cut. If the blade does not turn when you squeeze the throttle trigger, make sure shaft is fully inserted into the engine.

Always release the throttle trigger and allow engine to return to idle speed when not cutting. The blade should not turn while the engine is running at idle. If the blade turns at idle, do not use your unit. Refer to the CARBURETOR ADJUSTMENT section or contact your authorized service dealer.

- Maintain good firm footing while using the unit. Do this by planting feet firmly in a comfortable apart position.
- Cut while swinging the upper part of your body from left to right.
- As you move forward to the next area to cut, be sure to maintain your balance and footing.

RECOMMENDED CUTTING POSITION

Cut using the 2 o'clock to 4 o'clock position of the blade

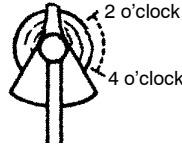

WARNING: The operator or others must not try to clear away cut material with the engine running or the blade turning to avoid serious injury. Stop engine and blade before removing materials wrapped around blade or shaft.

MAINTENANCE

WARNING: Disconnect the spark plug before performing maintenance except for carburetor adjustments.

HELPFUL TIP

IMPORTANT: Have all repairs other than the recommended maintenance described in the instruction manual performed by an authorized service dealer.

If any dealer other than an authorized service dealer performs work on the product, Poulan PRO may not pay for repairs under warranty. It is your responsibility to maintain and perform general maintenance.

CHECK FOR LOOSE FASTENERS AND PARTS

- Spark Plug Boot
- Air Filter
- Housing Screws
- Assist Handle Screw
- Debris Shield

CHECK FOR DAMAGED OR WORN PARTS

Contact an authorized service dealer for replacement of damaged or worn parts.

- ON/OFF Switch - Ensure ON/OFF switch functions properly by moving the switch to the OFF position. Make sure engine stops; then restart engine and continue.
- Fuel Tank - Discontinue use of unit if fuel tank shows signs of damage or leaks.
- Debris Shield - Discontinue use of unit if debris shield is damaged.

INSPECT AND CLEAN UNIT AND DECALS

- After each use, inspect complete unit for loose or damaged parts. Clean the unit and decals using a damp cloth with a mild detergent.
- Wipe off unit with a clean dry cloth.

CLEAN AIR FILTER

A dirty air filter decreases engine performance and increases fuel consumption and harmful emissions. Always clean after every 5 hours of operation.

1. Clean the cover and the area around it to keep dirt from falling into the carburetor chamber when the cover is removed.
2. Remove parts by pressing button to release air filter cover.

NOTE: To avoid creating a fire hazard or producing harmful evaporative emissions, do not clean filter in gasoline or other flammable solvent.

3. Wash the filter in soap and water.
4. Allow filter to dry.
5. Replace parts.

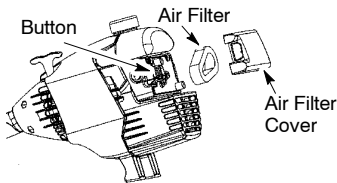

INSPECT MUFFLER AND SPARK ARRESTING SCREEN

⚠ WARNING: The muffler on this product contains chemicals known to the State of California to cause cancer. As your unit is used, carbon deposits build up on the muffler and spark arresting screen and must be removed to avoid creating a fire hazard or affecting engine performance.

For normal homeowner use, the muffler and spark arresting screen will not require any service. After 50 hours of use, we recommend that your muffler be serviced or replaced by an authorized service dealer.

REPLACE SPARK PLUG

Replace the spark plug each year to ensure the engine starts easier and runs better. Set spark plug gap at 0.025 inch (0.6 mm). Ignition timing is fixed and nonadjustable.

1. Twist, then pull off spark plug boot.
2. Remove spark plug from cylinder and discard.
3. Replace with Champion RCJ-6Y spark plug and tighten securely with a 3/4 inch (19 mm) socket wrench.
4. Reinstall the spark plug boot.

SERVICE AND ADJUSTMENTS

REPLACING THE LINE

1. Press the tabs on the side of the trimmer head and remove cover and spool.

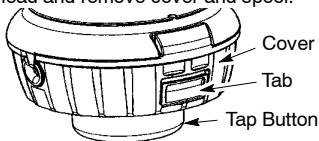

2. Remove any remaining line.
3. Clean dirt and debris from all parts. Replace spool if it is worn or damaged.
4. Replace with a pre-wound spool, or replace line using a 15 feet (4.5 meters) length of 0.095 inch (2.4 mm) diameter Poulan PRO brand line.
5. When installing new line on an existing spool, hold the spool as shown in the illustration below.
6. Bend the line at the midpoint and insert the bend into the slot in the center rim of the spool. Ensure line snaps into position in the slot.

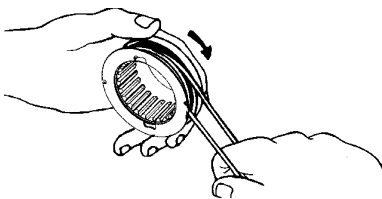
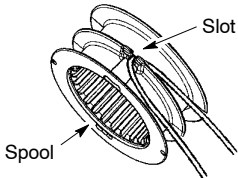

7. With your finger between the lines, wrap the lines evenly and firmly around the spool in a clockwise direction.

8. Position the lines in the guide slots.

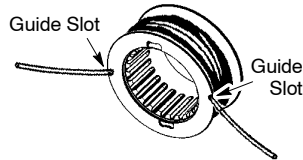

9. Insert the ends of the lines through exit holes in the sides of the cover.
10. Place the spool in the cover.

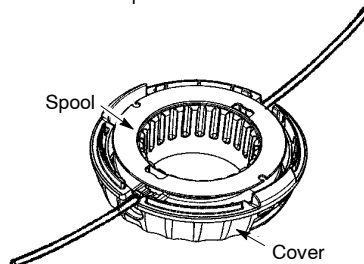

11. Make sure the lines are not caught between the rim of the spool and the wall of the cover.
12. Reinstall the spool and cover onto the trimmer head. Push until cover snaps into place.

BLADE REPLACEMENT

Refer to the ASSEMBLY section for blade replacement instructions and illustrations.

CARBURETOR ADJUSTMENT

⚠ WARNING: Keep others away when making idle speed adjustments. The trimmer head, blade or any optional attachment will be spinning during most of this procedure. Wear your protective equipment and observe all safety precautions. After making adjustments, the trimmer head, blade or any optional attachment must not move/spin at idle speed.

The carburetor has been carefully set at the factory. Adjustments may be necessary if you notice any of the following conditions:

- Engine will not idle when the throttle is released.
- The trimmer head, blade or optional attachment moves/spins at idle.

Make adjustments with the unit supported so the cutting attachment is off the ground and will not make contact with any object. Hold the unit by hand while running and making adjustments. Keep all parts of your body away from the cutting attachment and muffler.

Idle Speed Adjustment

Allow engine to idle. Adjust speed until engine runs without trimmer head, blade or optional attachment moving or spinning (idle too fast) or stalling (idle speed too slow).

- Turn idle speed screw clockwise to increase engine speed if engine stalls or dies.
- Turn idle speed screw counterclockwise to decrease engine speed if trimmer head, blade or optional attachment moves or spins at idle.

WARNING: Recheck the idle speed after each adjustment. The trimmer head, blade or optional attachment must not move or spin at idle speed to avoid serious injury to the operator or others.

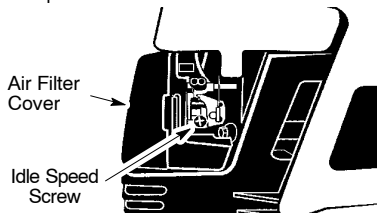

If you require further assistance or are unsure about performing this procedure, contact an authorized service dealer or call 1-800-554-6723.

STORAGE

WARNING: Perform the following steps after each use:

- Allow engine to cool before storing or transporting.
- Store unit and fuel in a well ventilated area where fuel vapors cannot reach sparks or open flames from water heaters, electric motors or switches, furnaces, etc.
- Store unit with all guards in place. Position unit so that any sharp object cannot accidentally cause injury.
- Store unit and fuel well out of the reach of children.

SEASONAL STORAGE

Prepare unit for storage at end of season or if it will not be used for 30 days or more.

If your unit is to be stored for a period of time:

- Clean the entire unit before lengthy storage.
- Store in a clean dry area.
- Lightly oil external metal surfaces.

FUEL SYSTEM

Under FUELING ENGINE in the OPERATION section of this manual, see message labeled IMPORTANT regarding the use of gasoline in your engine.

Fuel stabilizer is an acceptable alternative in minimizing the formation of fuel gum deposits during storage. Add stabilizer to the gasoline in the fuel tank or fuel storage container. Follow the mix instructions found on stabilizer container. Run engine at least 5 minutes after adding stabilizer.

HELPFUL TIP

During storage of your gas/oil mixture, the oil will separate from the gas.

We recommend that you shake the gas can weekly to insure proper blending of the gas and oil.



ENGINE

- Remove spark plug and pour 1 teaspoon of 40:1, 2-cycle engine oil (air cooled) through the spark plug opening. Slowly pull the starter rope 8 to 10 times to distribute oil.
- Replace spark plug with new one of recommended type and heat range.
- Clean air filter.
- Check entire unit for loose screws, nuts, and bolts. Replace any damaged, broken, or worn parts.
- At the beginning of the next season, use only fresh fuel having the proper gasoline to oil ratio.

OTHER

- Do not store gasoline from one season to another.
- Replace your gasoline can if it starts to rust.

TROUBLESHOOTING TABLE



WARNING: Always stop unit and disconnect spark plug before performing all of the recommended remedies below except remedies that require operation of the unit.

TROUBLE	CAUSE	REMEDY
Engine will not start.	<ol style="list-style-type: none"> 1. ON/OFF switch in OFF position. 2. Engine flooded. 3. Fuel tank empty. 4. Spark plug not firing. 5. Fuel not reaching carburetor. 6. Carburetor requires adjustment. 	<ol style="list-style-type: none"> 1. Move ON/OFF switch to the ON position. 2. See "Starting a Flooded Engine" in Operation Section. 3. Fill tank with correct fuel mixture. 4. Install new spark plug. 5. Check for dirty fuel filter; replace. Check for kinked or split fuel line; repair or replace. 6. Contact an authorized service dealer.
Engine will not idle properly.	<ol style="list-style-type: none"> 1. Carburetor requires adjustment. 2. Crankshaft seals worn. 3. Compression low. 	<ol style="list-style-type: none"> 1. See "Carburetor Adjustment" in Service and Adjustments Section. 2. Contact an authorized service dealer. 3. Contact an authorized service dealer.
Engine will not accelerate, lacks power, or dies under a load.	<ol style="list-style-type: none"> 1. Air filter dirty. 2. Spark plug fouled. 3. Carburetor requires adjustment. 4. Carbon build-up on muffler outlet screen. 5. Compression low. 	<ol style="list-style-type: none"> 1. Clean or replace air filter. 2. Clean or replace plug and regap. 3. Contact an authorized service dealer. 4. Contact an authorized service dealer. 5. Contact an authorized service dealer.
Engine smokes excessively.	<ol style="list-style-type: none"> 1. Choke partially on. 2. Fuel mixture incorrect. 3. Air filter dirty. 4. Carburetor requires adjustment. 	<ol style="list-style-type: none"> 1. Adjust choke. 2. Empty fuel tank and refill with correct fuel mixture. 3. Clean or replace air filter. 4. Contact an authorized service dealer.
Engine runs hot.	<ol style="list-style-type: none"> 1. Fuel mixture incorrect. 2. Spark plug incorrect. 3. Carburetor requires adjustment. 4. Carbon build-up on muffler outlet screen. 	<ol style="list-style-type: none"> 1. See "Fueling Engine" in Operation section. 2. Replace with correct spark plug. 3. Contact an authorized service dealer. 4. Contact an authorized service dealer.

LIMITED WARRANTY

Poulan PRO warrants to the original purchaser that each new **Poulan PRO** brand gasoline tool or attachment is free from defects in material and workmanship and agrees to repair or replace under this warranty any defective gasoline product or attachment as follows from the original date of purchase.

2 YEARS - Parts and Labor, when used for household purposes.

90 DAYS - Parts and Labor, when used for commercial, professional, or income producing purposes.

30 DAYS - Parts and Labor, if used for rental purposes.

This warranty is not transferable and does not cover damage or liability caused by improper handling, improper maintenance, or the use of accessories and/or attachments not specifically recommended by **Poulan PRO** for this tool. Additionally, this warranty does not cover tune-ups, spark plugs, filters, cutting line, or rotating head parts that will wear and require replacement with reasonable use during the warranty period. This warranty does

not cover predelivery setup or normal adjustments explained in the instruction manual.

THIS WARRANTY GIVES YOU SPECIFIC LEGAL RIGHTS, AND YOU MAY HAVE OTHER RIGHTS WHICH VARY FROM STATE TO STATE. NO CLAIMS FOR CONSEQUENTIAL OR OTHER DAMAGES WILL BE ALLOWED, AND THERE ARE NO OTHER EXPRESS WARRANTIES EXCEPT THOSE EXPRESSLY STIPULATED HEREIN.

SOME STATES DO NOT ALLOW LIMITATIONS ON HOW LONG AN IMPLIED WARRANTY LASTS OR THE EXCLUSION OR LIMITATIONS OF INCIDENTAL OR CONSEQUENTIAL DAMAGES, SO THE ABOVE LIMITATIONS OR EXCLUSION MAY NOT APPLY TO YOU.

The policy of **Poulan PRO** is to continuously improve its products. Therefore, **Poulan PRO** reserves the right to change, modify, or discontinue models, designs, specifications, and accessories of all products at any time without notice or obligation to any purchaser.

U.S. EPA / CALIFORNIA / ENVIRONMENT CANADA EMISSION CONTROL WARRANTY STATEMENT

YOUR WARRANTY RIGHTS AND OBLIGATIONS: The U.S. Environmental Protection Agency/California Air Resources Board, Environment Canada and Poulan/WEED EATER are pleased to explain the emissions control system warranty on your year 2005 and later small off-road engine. In California, all small off-road engines must be designed, built, and equipped to meet the State's stringent anti-smog standards. Poulan/WEED EATER must warrant the emission control system on your small off-road engine for the periods of time listed below provided there has been no abuse, neglect, or improper maintenance of your small off-road engine. Your emission control system includes parts such as the carburetor and the ignition system. Where a warrantable condition exists, Poulan/WEED EATER will repair your small off-road engine engine at no cost to you. Expenses covered under warranty include diagnosis, parts and labor. **MANUFACTURER'S WARRANTY COVERAGE:** If any emissions related part on your engine (as listed under Emissions Control Warranty Parts List) is defective or a defect in the materials or workmanship of the engine causes the failure of such an emission related part, the part will be repaired or replaced by Poulan/WEED EATER. **OWNER'S WARRANTY RESPONSIBILITIES:** As the small off-road engine engine owner, you are responsible for the performance of the required maintenance listed in your instruction manual. Poulan/WEED EATER recommends that you retain all receipts covering maintenance on your small off-road

engine, but Poulan/WEED EATER cannot deny warranty solely for the lack of receipts or for your failure to ensure the performance of all scheduled maintenance. As the small off-road engine engine owner, you should be aware that Poulan/WEED EATER may deny you warranty coverage if your small off-road engine engine or a part of it has failed due to abuse, neglect, improper maintenance, unapproved modifications, or the use of parts not made or approved by the original equipment manufacturer. You are responsible for presenting your small off-road engine to a Poulan/WEED EATER authorized repair center as soon as a problem exists. Warranty repairs should be completed in a reasonable amount of time, not to exceed 30 days. If you have any questions regarding your warranty rights and responsibilities, you should contact your nearest authorized service center or call Poulan/WEED EATER at 1-800-554-6723. **WARRANTY COMMENCEMENT DATE:** The warranty period begins on the date the small off-road engine is purchased. **LENGTH OF COVERAGE:** This warranty shall be for a period of two years from the initial date of purchase. **WHAT IS COVERED: REPAIR OR REPLACEMENT OF PARTS.** Repair or replacement of any warranted part will be performed at no charge to the owner at an approved Poulan/WEED EATER servicing center. If you have any questions regarding your warranty rights and responsibilities, you should contact your nearest authorized service center or call Poulan/WEED EATER at 1-800-554-6723.

WARRANTY PERIOD: Any warranted part which is not scheduled for replacement as required maintenance, or which is scheduled only for regular inspection to the effect of "repair or replace as necessary" shall be warranted for 2 years. Any warranted part which is scheduled for replacement as required maintenance shall be warranted for the period of time up to the first scheduled replacement point for that part. **DIAGNOSIS:** The owner shall not be charged for diagnostic labor which leads to the determination that a warranted part is defective if the diagnostic work is performed at an approved Poulan/WEED EATER servicing center. **CONSEQUENTIAL DAMAGES:** Poulan/WEED EATER may be liable for damages to other engine components caused by the failure of a warranted part still under warranty. **WHAT IS NOT COVERED:** All failures caused by abuse, neglect, or improper maintenance are not covered. **ADD-ON OR MODIFIED PARTS:** The use of add-on or modified parts can be grounds for disallowing a warranty claim. Poulan/WEED EATER is not liable to

cover failures of warranted parts caused by the use of add-on or modified parts. **HOW TO FILE A CLAIM:** If you have any questions regarding your warranty rights and responsibilities, you should contact your nearest authorized service center or call Poulan/WEED EATER at 1-800-554-6723. **WHERE TO GET WARRANTY SERVICE:** Warranty services or repairs shall be provided at all Poulan/WEED EATER service centers. Call: 1-800-554-6723. **MAINTENANCE, REPLACEMENT AND REPAIR OF EMISSION RELATED PARTS:** Any Poulan/WEED EATER approved replacement part used in the performance of any warranty maintenance or repair on emission related parts will be provided without charge to the owner if the part is under warranty. **EMISSION CONTROL WARRANTY PARTS LIST:** Carburetor, Ignition System: Spark Plug (covered up to maintenance schedule), Ignition Module, Muffler including catalyst. **MAINTENANCE STATEMENT:** The owner is responsible for the performance of all required maintenance as defined in the instruction manual.

The information on the product label indicates which standard your engine is certified.
Example: (Year) EPA Phase 1 or Phase 2 and/or CALIFORNIA.

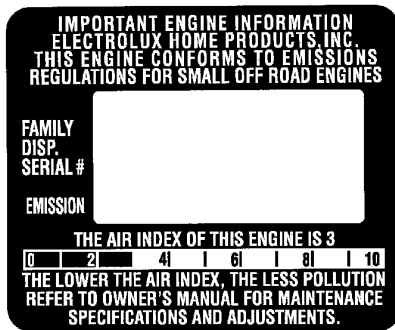

This engine is certified to be emissions compliant for the following use:

- Moderate (50 hours)
- Intermediate (125 hours)
- Extended (300 hours)