



## BiliTx

Parents' Manual



REF1045219



\*+H906104521909\*

Manufactured for  
Philips Children's Medical Ventures  
191 Wyngate Drive  
Monroeville, PA 15146

EC REP  
Respironics Deutschland  
Gewerbestrasse 17  
82211 Herrsching, Germany



1075310  
HM 5/18/10

**PHILIPS**  
Children's  Medical Ventures



# Table of Contents

1. Overview .....	3
Intended Use .....	3
What is the BiliTx Phototherapy System?.....	3
Components of the BiliTx System.....	4
2. Warnings, Cautions, and Symbols.....	5
Warnings.....	5
Cautions .....	6
Symbols.....	7
3. Setup .....	9
Setup - Wrap-Around Panel .....	10
Setup - Flat Neonatal Panel.....	11
4. Cleaning .....	13
Cleaning the Illuminator Device and Fiber Optic Panel .....	13
Customer Service Information.....	14
5. Troubleshooting.....	15
6. Specifications .....	17
Environmental .....	17
Physical.....	17
Illuminator .....	17
Fiber Optic Panel .....	17
Light Source.....	18
Irradiance Level.....	18
Intensity Ratio .....	18
Audible Noise.....	18
Standards Compliance.....	18
Electrical Requirements.....	18
Disposal.....	18
Appendix A: EMC Information.....	19
BiliTx Warranty .....	23



# 1. Overview

This chapter explains how the BiliTx Phototherapy System is used to treat infant jaundice and it lists the components of the BiliTx system.

## Intended Use

The BiliTx is intended to treat hyperbilirubinemia through phototherapy.

## What is the BiliTx Phototherapy System?

The BiliTx phototherapy system uses blue light emitting diodes (LEDs) to convert bilirubin to waste products that are mostly excreted through urine and stool, thus reducing the bilirubin level in the baby's blood.

The Illuminator device sends light out of the fiber optic cable to the entire area of the panel. The panel is inserted into a protective cover. This wrap is soft and comfortable and allows the therapeutic light to be emitted towards the baby. With this use of the BiliTx system, the baby can be held and fed and enjoy the healing comfort of parents while treatment is administered. Additionally, when the BiliTx system is properly used with the fiber optic panel the baby's eyes do not need to be protected as with conventional phototherapy.

## Components of the BiliTx System

The BiliTx system may include the following components. Note that some components may vary from those shown below or may be optional accessories that are not packaged with your device .

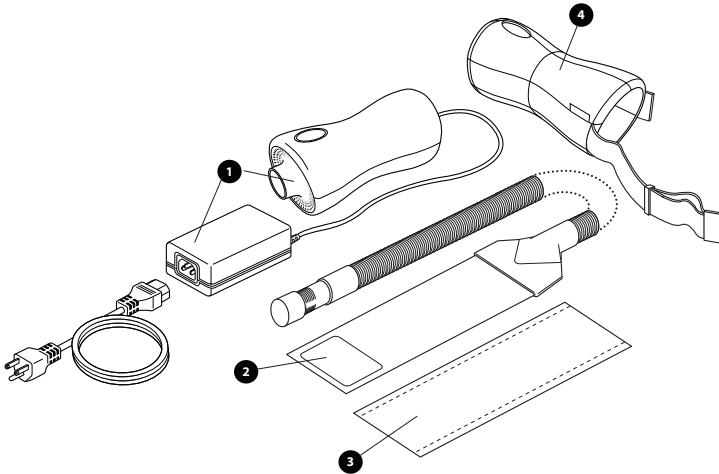

### Fiber Optic Light Panel Configuration

1. Illuminator Device with AC Power Cord
2. Fiber Optic Panel
3. Disposable Cover
4. Illuminator Device Carrying Case
5. System Carrying Case (optional) (not shown)
6. Parents' Manual (not shown)
7. Quick Start Guide (not shown)



### Fiber Optic Light Panel Configuration Contents

## 2. Warnings, Cautions, and Symbols

*Caution! US federal law restricts this device to sale by or on the order of a physician.*

### Warnings

- Use the BiliTx only for its intended use as described in this manual.
- Bilirubin photoisomers may cause toxic effects.
- Do not leave the Illuminator device on when the fiber optic panel is not around the baby.
- Always turn off and unplug the Illuminator device during cleaning or servicing.
- Do not use the BiliTx system in the presence of flammable substances such as anesthetics, cleaning agents, or gases that support combustion (e.g. oxygen, nitrous oxide).
- Do not use while bathing the baby.
- Do not place or store the BiliTx system where it can fall or be pulled into a tub or sink.
- If the Illuminator device falls into water or if fluid is spilled on the device do not reach for it without first unplugging the cord. Discontinue use of the device and contact your home care provider.
- Never operate the Illuminator device if it has a damaged plug or damaged or frayed power cord or wires. Do not insert anything into the end of the plug.
- Do not use an extension cord.
- Always connect the device to a properly grounded outlet.



*A warning indicates the possibility of injury to the user or operator.*

- If therapy is interrupted for any reason, resume therapy as soon as possible and contact your home care provider.
- Carefully place the panel cable to avoid entanglement.
- Position the Illuminator device on a stable surface, preferably lower than the infant. When the BiliTx system is used with the fiber optic panel configuration and carrying case, the device can hang on the outside of a crib or treatment area.
- Do not place the Illuminator device, power supply, or carrying case in an incubator or infant warmer.
- Do not place a temperature sensor for the infant warmer or incubator under the fiber optic panel.
- Do not place the Illuminator device, power supply, or carrying case in a crib or other treatment area next to the baby.
- Never block the air vents of the unit or place it on a soft surface such as a bed, crib, carpeted floor, or couch where the air vents may be blocked.
- During phototherapy, the the baby's water balance may become disturbed. Before and during phototherapy, make sure the baby is properly hydrated and that his or her body temperature is maintained.
- After treatment has begun, the baby's bilirubin level should be measured to make sure therapy is effective.
- The fiber optic panel must not be covered by anything except with the cover provided. Any other type of cover will cause a reduction in light intensity. The setup instructions must be followed exactly.

## Cautions

- Keep the unit away from any heated surface.
- Do not scratch, damage, or soil the ferrule end of the panel. Also, do not place sharp or heavy items on the panel, this can damage the panel and affect its light output.
- Do not dry the fiber optic panel with artificial heat.
- If the device is dropped, contact your home care provider.









*A caution indicates the possibility of damage to the device.*



## Symbols

The following symbols appear on the BiliTx system.

Symbol	Explanation
	Therapy On/Off
	Consult accompanying instructions for use
	Type BF applied part
	AC Power
	European Declaration of Conformity
	Canadian/US Safety Certification. Conforms to ANSI/UL STD. 2601. Certified to CAN/CSA C22.2 STD. NO. 601.1.
	Lock and Unlock



## 3. Setup

### Setting Up the BiliTx System

1. Place the appropriate cover on the panel and position the baby and panel as described later in this chapter. (See Setup-Wrap Around Panel or Flat Neonatal Panel.)
2. Place the Illuminator device on a hard, flat surface or using the carrying case, hang the unit on the outside of a crib or the treatment area, away from any heat source. Make sure it is no more than four feet from where the baby will be positioned.
3. Insert the metal end of the light panel cable, called the ferrule, with the metal post facing up, into the opening on the Illuminator unit. Push the ferrule in and rotate it counter-clockwise to lock into place. The light will not come on if the panel is not inserted in the Illuminator device.
4. Plug the Illuminator device into an electrical outlet. The power button will flash green.

 **CAUTION**

*If the power cord or wires need repair or replacement, do not connect the device.*

5. Press the Therapy On/Off button to turn the Illuminator device on and begin phototherapy. The Therapy button will illuminate green.

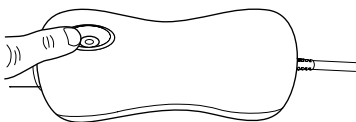

6. To turn off the device when therapy is complete, press and hold the Therapy On/Off button for 3 seconds.

 **WARNING**

*After treatment has begun, the baby's bilirubin level should be measured to make sure therapy is effective.*

 **CAUTION**

*Do not block any of the air vents on the Illuminator device.*

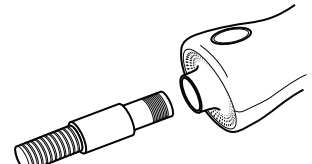

**Connecting the light panel cable to the illuminator device**



**Turning on the illuminator device**

## Setup - Wrap-Around Panel

This section explains how to prepare your baby for a phototherapy treatment using the wrap-around fiber optic light panel.

The fiber optic panel must NOT be covered by anything except with the cover provided. Any other type of cover could cause a reduction in light intensity. The setup instructions must be followed exactly.

This panel provides full coverage around the baby's torso.

1. Place a disposable or reusable cover onto the panel with the light emitting side of the panel facing the sheer side of the cover.

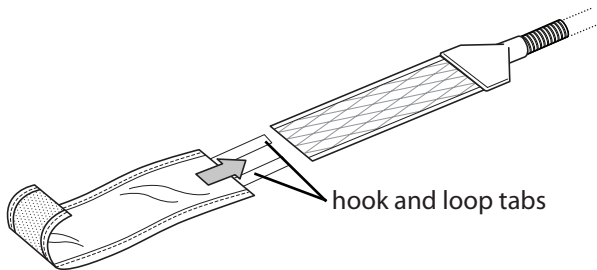

2. Place the covered panel under the baby's torso, positioning it so it is under the baby's armpits.
3. Wrap the panel around the baby. Use the tape or hook and loop tabs to secure the panel around the baby.
4. If the disposable cover becomes soiled, discard it and replace with a clean one. The cloth cover may be washed with mild soap and water.

### NOTES

*For a larger or more active baby, you may want to tape the panel to the baby's diaper.*

*To be sure the panel is not wrapped too tightly, insert your finger between the panel and the baby's body. Your finger should fit easily.*

*You may wrap the baby in a blanket or put the baby in a sleeper.*

### WARNING

*If using tape to secure the panel, do not adhere the tape to the baby's skin.*



**Wrap-around panel with disposable cover**



**Positioning the fiber optic panel**

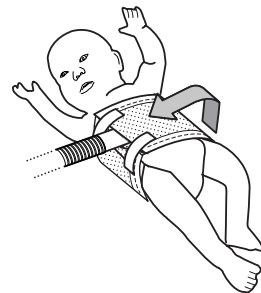

**Wrapping and securing the panel**

## Setup - Flat Neonatal Panel

This section explains how to prepare a baby for a phototherapy treatment using the flat neonatal fiber optic light panel.

The fiber optic panel must NOT be covered by anything except with the disposable cover provided. Any other type of cover could cause a reduction in light intensity. The setup instructions must be followed exactly.

This panel is ideal for preemie or underweight infants; it may also be used on full-term infants.

1. The protective cover for the neonatal panel is a T-vest. Slide the vertical section of the T, with the light facing the sheer side of the cover, onto the panel.

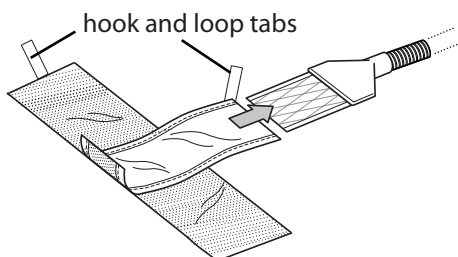

2. Lay the covered panel on a flat surface. Be sure the light emitting side is facing up.
3. Position the baby's chest or back directly on the panel. The cable connected to the panel should be between the baby's legs.
4. Secure the T-vest to the baby by first wrapping the side without the tape or hook and loop tab around the baby's midsection. Then, wrap the side with the tape or hook and loop tab over the infant. If using tape, peel off the protective cover on the tab, and secure it. Be sure the vest is snug.



**Neonatal panel with t-vest**

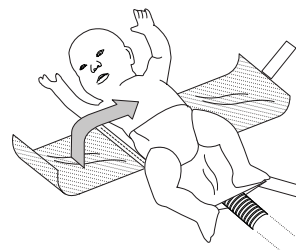

**Positioning the baby on the panel**

5. If your cover has the hook and loop tabs, you can secure the cover by pulling the hook and loop tab on the bottom corner of the cover up and across the cover, tightening the cover around the cable between the baby's legs.
6. If the T-vest becomes soiled, discard it and replace it with a new one.

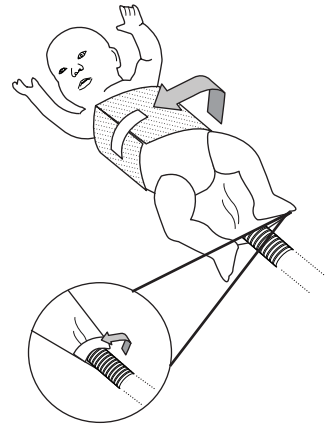

**Wrapping and securing the T-vest**

## NOTES

*For a larger or more active baby, you may want to tape the panel to the baby's diaper.*

*To be sure the panel is not wrapped too tightly, insert your finger between the panel and the baby's body. Your finger should fit easily.*

*You may wrap the baby in a blanket or put the baby in a sleeper.*



## WARNING

*If using tape to secure the panel, do not adhere the tape to the baby's skin.*

## Using the In-Use Carrying Case

An optional, in-use carrying case is available for use with the Illuminator device. The carrying case allows for easy mobility during phototherapy treatment. To place the carrying case on the Illuminator device, simply slide it over the device and adjust the position so that the Start/Stop button is visible. The shoulder strap should be located at the same end as the power cord. You can adjust the shoulder strap as necessary using the hook and loop tabs.

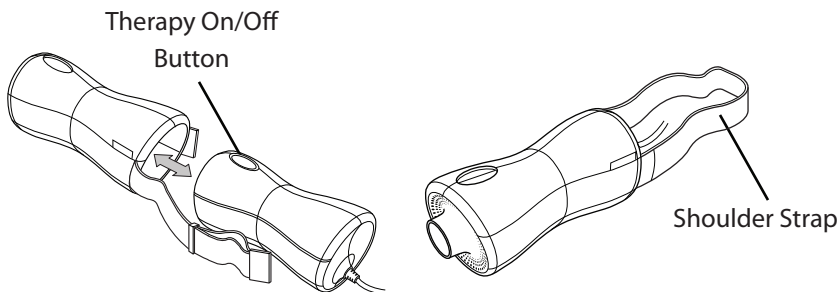

## 4. Cleaning

This section explains how to clean the BiliTx system.

### Cleaning the Illuminator Device and Fiber Optic Panel

Follow the instructions in this section any time the Illuminator device or fiber optic panel is dirty.

1. Use soapy water, a 10% bleach solution or full strength ammonia.
2. Use a soft sponge or cloth to apply the cleaner.
3. Apply the cleaning solution to the sponge or cloth and wipe down the fiber optic panel and Illuminator.
4. Allow the equipment to air dry. **DO NOT DRY WITH ANY MEANS OF ARTIFICIAL HEAT.**
5. Wipe the Illuminator device and panel with a dry cloth.

If the in-use carrying case becomes soiled, it can be wiped with a damp cloth.

 **CAUTION**

*Be sure the Illuminator device is turned off and is unplugged before cleaning. Do not immerse any part of the equipment in any liquid.*

 **CAUTION**

*Keep the fiber optic panel away from sharp objects that could scratch or puncture the cover.*

 **WARNING**

*When cleaning, DO NOT USE:*

- Phenolic compound based germicide cleaner/disinfectant
- Gluteraldehyde disinfectant/sterilants
- Regular commercial cleaners or laundry detergents
- Iodine solutions, strong acids or strong alkali solutions

*These solutions could leave residue on the surfaces, and / or be abrasive or harmful to the infant.*

## Customer Service Information

If you need to contact Philips Children's Medical Ventures directly, call the Philips Children's Medical Ventures Customer Service department at 1-800-345-6443 or 1-724-387-4000.

You can also use the following address:

Children's Medical Ventures, LLC  
191 Wyngate Drive  
Monroeville, Pennsylvania  
15146 USA

### **HELPFUL TIP**

*Visit Philips Children's Medical Ventures web site at [www.philips.com/childmed](http://www.philips.com/childmed).*



# 5. Troubleshooting

The following is a list of problems that may occur while using the BiliTx system. For additional information, contact your home care provider or contact Philips Children's Medical Ventures Customer Service at 1-800-345-6443 or 724-387-4000.



## WARNING

*If therapy is interrupted for one hour or longer, resume therapy as soon as possible and contact your home care provider.*

Problem	Reason/Action
Therapy On/Off button is not green	Check to make sure power cord is properly attached and plugged into an active electrical outlet.  Ensure the device is turned on.
Therapy On/Off button is not flashing green	If the power cord is properly attached and plugged into an active electric outlet and the Therapy On/Off button is not flashing green, but the device will turn on, continue to use the device for therapy.
Light is not being emitted from fiber optic panel	Check to make sure panel is securely locked into Illuminator device.
Yellow LED is flashing	Ensure the panel or circuit support adapter is securely locked into place. If light continues to flash, contact your home care provider.
Loss of power or light source failure	Contact your home care provider.
Device will not turn off when the Therapy On/Off button is pressed	Press and hold the Therapy On/Off button for 3 seconds.



## 6. Specifications

### Environmental

	Storage	Operating
Temperature	-4 to 122° F (-20 to +50° C)	59 to 95° F (15 to 35° C)
Relative Humidity	15-95% Non-condensing	15-95% Non-condensing

### Physical

#### Illuminator

Size: 6.34 in. x 2.92 in. (16.10 cm x 7.40 cm)

Weight: <2.50 lb. (1.13 kg)

#### Fiber Optic Panel

<b>Model:</b>	<b>EG-2000 (Wrap Around Panel)</b>
Overall Pad Size-Standard:	4.00" x 15.00" (10.16 cm x 38.10 cm)
Illuminated Area-Standard:	3.00" x 14.00" (7.62 cm x 35.56 cm)
<b>Model:</b>	<b>EG-2000N (Flat Neonatal Panel)</b>
Overall Pad Size-Neonatal:	5.00" x 7.00" (12.70 cm x 17.78 cm)
Illuminated Area-Neonatal:	4.00" x 6.00" (10.16 cm x 15.24 cm)

## Light Source

### Irradiance Level

Standard Panel-Light: 30 $\mu$ W/cm<sup>2</sup>/nm

Neonatal Panel-Light: 55 $\mu$ W/cm<sup>2</sup>/nm

### Intensity Ratio

Standard Panel and Neonatal Panel : > .4 (minimum to maximum)

## Audible Noise

< 60 dB(A). Measured in accordance with IEC 60601-2-50.

## Standards Compliance

This device is designed to conform to the following standards:

- IEC 60601-1 General Requirements for Safety of Medical Electrical Equipment
- IEC 60601-2-50 Requirements for the Safety of Infant Phototherapy Equipment
- Electromagnetic Compatibility: EN 60601-1-2, 2nd edition.

## Electrical Requirements

AC Power	100-240 VAC, 50/60 Hz, 1.0 A
Type of Protection Against Electrical Shock	Class I Equipment
Degree of Protection Against Electrical Shock	Type BF Applied Part
Degree of Protection Against Ingress of Water	Ordinary Protection, IPX0
Mode of Operation	Continuous

## Disposal

Dispose of this device in accordance with local regulations.

# Appendix A: EMC Information

## Guidance and Manufacturer's Declaration - Electromagnetic Emissions

This device is intended for use in the electromagnetic environment specified below. The user of this device should make sure it is used in such an environment.

Emissions Test	Compliance	Electromagnetic Environment - Guidance
RF emissions CISPR 11	Group 1	The device uses RF energy only for its internal function. Therefore, its RF emissions are very low and are not likely to cause any interference in nearby electronic equipment.
RF emissions CISPR 11	Class B	The device is suitable for use in all establishments, including domestic establishments and those directly connected to the public low-voltage power supply network.
Harmonic emissions IEC 61000-3-2	Class A	
Voltage fluctuations/Flicker emissions IEC 61000-3-3	Complies	

## Guidance and Manufacturer's Declaration - Electromagnetic Immunity

This device is intended for use in the electromagnetic environment specified below. The user of this device should make sure it is used in such an environment.

Immunity Test	IEC 60601 Test Level	Compliance Level	Electromagnetic Environment - Guidance
Electrostatic Discharge (ESD) IEC 61000-4-2	±6 kV contact ±8 kV air	±6 kV contact ±8 kV air	Floors should be wood, concrete or ceramic tile. If floors are covered with synthetic material, the relative humidity should be at least 30%.
Electrical Fast Transient/Burst IEC 61000-4-4	±2 kV for power supply lines ±1 kV for input-output lines	±2 kV for supply mains ±1 kV for input/output lines	Mains power quality should be that of a typical home or hospital environment.
Surge IEC 61000-4-5	±1 kV differential mode ±2 kV common mode	±1 kV differential mode ±2 kV for common mode	Mains power quality should be that of a typical home or hospital environment.
Voltage dips, short interruptions and voltage variations on power supply input lines IEC 61000-4-11	<5% $U_T$ (>95% dip in $U_T$ ) for 0.5 cycle 40% $U_T$ (60% dip in $U_T$ ) for 5 cycles 70% $U_T$ (30% dip in $U_T$ ) for 25 cycles <5% $U_T$ (>95% dip in $U_T$ ) for 5 sec	<5% $U_T$ (>95% dip in $U_T$ ) for 0.5 cycle 40% $U_T$ (50% dip in $U_T$ ) for 5 cycles 70% $U_T$ (30% dip in $U_T$ ) for 25 cycles <5% $U_T$ (>95% dip in $U_T$ ) for 5 sec	Mains power quality should be that of a typical home or hospital environment.
Power frequency (50/60 Hz) magnetic field IEC 61000-4-8	3 A/m	3 A/m	Power frequency magnetic fields should be at levels characteristic of a typical location in a typical hospital or home environment.
NOTE: $U_T$ is the a.c. mains voltage prior to application of the test level.			

## Guidance and Manufacturer's Declaration - Electromagnetic Immunity

This device is intended for use in the electromagnetic environment specified below. The user of this device should make sure it is used in such an environment.

Immunity Test	IEC 60601 Test Level	Compliance Level	Electromagnetic Environment - Guidance
Conducted RF IEC 61000-4-6	3 Vrms 150 kHz to 80 MHz	3 Vrms	Portable and mobile RF communications equipment should be used no closer to any part of the device, including cables, than the recommended separation distance calculated from the equation applicable to the frequency of the transmitter.  <b>Recommended separation distance:</b> $d = 1.2 \sqrt{P}$ 150 kHz to 80 MHz  $d = 1.2 \sqrt{P}$ 80 MHz to 800 MHz $d = 2.3 \sqrt{P}$ 800 MHz to 2.5 GHz  Where P is the maximum output power rating of the transmitter in watts (W) according to the transmitter manufacturer and d is the recommended separation distance in meters (m).  Field strengths from fixed RF transmitters, as determined by an electromagnetic site survey <b>a</b> , should be less than the compliance level in each frequency range <b>b</b> .  Interference may occur in the vicinity of equipment marked with the following symbol: 
Radiated RF IEC 61000-4-3	3 V/m 80 MHz to 2.5 GHz	3 V/m	
<p><b>NOTE 1:</b> At 80 MHz and 800 MHz, the higher frequency range applies.</p> <p><b>NOTE 2:</b> These guidelines may not apply in all situations. Electromagnetic propagation is affected by absorption and reflection from structures, objects, and people.</p> <p><b>a:</b> Field strengths from fixed transmitters, such as base stations for radio (cellular/cordless) telephones and land mobile radios, amateur radio, AM and FM radio broadcast and TV broadcast cannot be predicted theoretically with accuracy. To assess the electromagnetic environment due to fixed RF transmitters, an electromagnetic site survey should be considered. If the measured field strength in the location in which the device is used exceeds the applicable RF compliance level above, the device should be observed to verify normal operation. If abnormal performance is observed, additional measures may be necessary, such as re-orienting or relocating the device.</p> <p><b>b:</b> Over the frequency range 150 kHz to 80 MHz, the field strengths should be less than 3 V/m.</p>			

## Recommended Separation Distances between Portable and Mobile RF Communications Equipment and this Device

The device is intended for use in an electromagnetic environment in which radiated RF disturbances are controlled. The customer or the user of this device can help prevent electromagnetic interference by maintaining a minimum distance between portable and mobile RF communications equipment (transmitters) and this device as recommended below, according to the maximum output power of the communications equipment.

Rated Maximum Power Output of Transmitter (W)	Separation Distance According to Frequency of Transmitter (m)		
	150 kHz to 80 MHz $d = 1.2 \sqrt{P}$	80 MHz to 800 MHz $d = 1.2 \sqrt{P}$	800 MHz to 2.5 GHz $d = 2.3 \sqrt{P}$
0.01	0.12	0.12	0.23
0.1	0.38	0.38	0.73
1	1.2	1.2	2.3
10	3.8	3.8	7.3
100	12	12	23

For transmitters rated at a maximum output power not listed above, the recommended separation distance  $d$  in meters (m) can be estimated using the equation applicable to the frequency of the transmitter, where  $P$  is the maximum output power rating of the transmitter in watts (W) according to the transmitter manufacturer.

**Note 1:** At 80 MHz and 800 MHz, the separation distance for the higher frequency range applies.

**Note 2:** These guidelines may not apply in all situations. Electromagnetic propagation is affected by absorption and reflection from structures, objects, and people.



# BiliTx Warranty

Children's Medical Ventures, LLC warrants your BiliTx Phototherapy System against defects in material and workmanship of the Illuminator device and the fiber optic panels, EG-2000 and EG-2000N, for a period of one (1) year from the date of purchase. In addition, Philips Children's Medical Ventures warrants the LED light engine for 20,000 hours. This warranty does not cover any damage to the illuminating device or the fiber optic panel caused by accident, misuse, tampering, or negligence such as failure to follow the instructions provided in this guide. In the event your phototherapy illumination unit fails to give satisfactory performance within the warranty period and conditions, Philips Children's Medical Ventures will repair or replace your illuminating device at no charge for parts or labor. The foregoing warranties are in lieu of all other warranties expressed or implied, including without limitation any implied warranty of merchantability or fitness for a particular purpose.

To exercise your rights under this warranty, contact your local authorized Philips Children's Medical Ventures dealer or contact Philips Children's Medical Ventures at:

191 Wyngate Drive  
Monroeville, PA 15146 USA  
1-800-345-6443

