

KF 2060

KF 2061 Aroma

KF 2062 Timer

Kaffeeautomaten
Coffee Machines
Cafetières
Caffettiere
Kahvinkeitimet
Automaty na kávu

Gebrauchsanweisung
Operating instructions
Mode d'emploi
Istruzioni per l'uso
Käyttöohje
Návod k použití

1

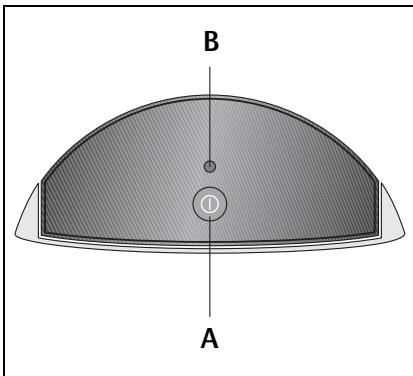

2a

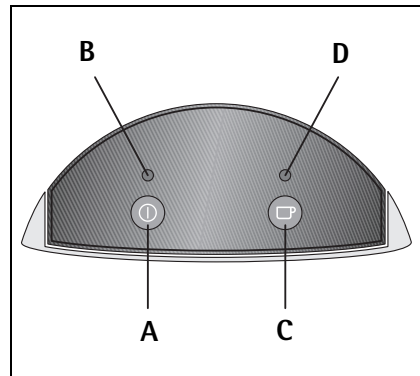

2b

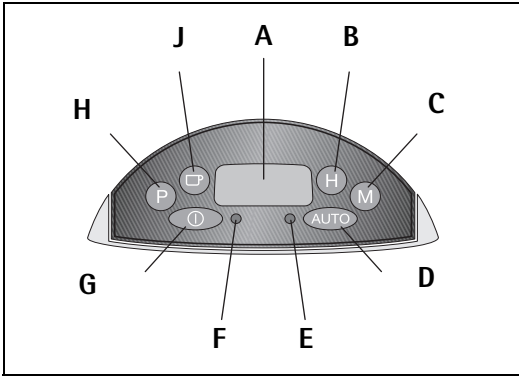

2c

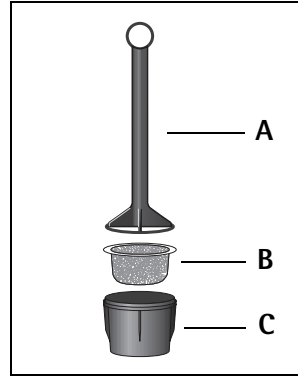

3

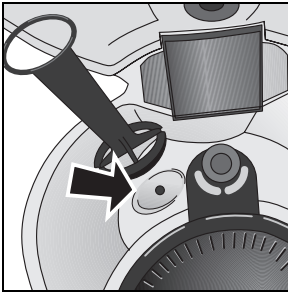

4

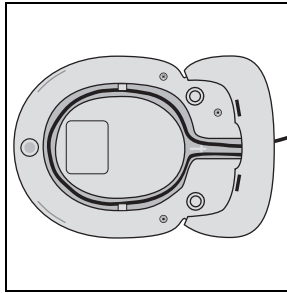

5

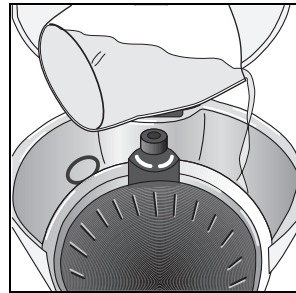

6



7

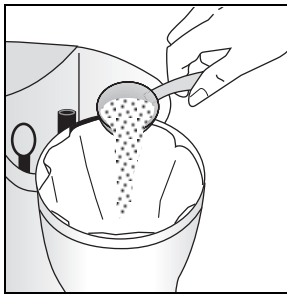

8

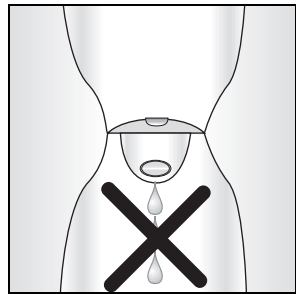

9



Dear Customer,

Please read these operating instructions carefully. Above all please observe the safety instructions on the initial pages of these operating instructions! Please keep the operating instructions for later reference. Pass them on to any subsequent owner of the appliance.

Features (Figure 1)

- A Water tank lid
- B Operating features (see Figures 2a/b/c)
- C Water tank
- D External water level gauge
- E Cord compartment
- F Non-stick warming plate
- G Rating plate (underside of appliance)
- H Coffee jug
- J Removable filter basket
- K Carbon filter system (see Figure 3)

Operating Features

Figure 2a (KF 2060)

- A On/off button
- B Indicator (red) for ON/OFF

Figure 2b (KF 2061 Aroma)

- A On/off button
- B Indicator (red) for ON/OFF
- C Aroma button
- D Indicator (green) for AROMA SETTING

Figure 2c (KF 2062 Timer)

- A Display for CLOCK TIME, START TIME and AROMA SETTING
- B HOURS button
- C MINUTES button
- D AUTO-START button
- E Indicator (green) for AUTO-START
- F Indicator (red) for ON/OFF
- G On/off button
- H Programme button
- J Aroma button

Carbon Filter System (Figure 3)

- A Filter holder handle
- B Carbon filter
- C Filter holder



Safety Instructions

- The operating voltage and mains voltage must match! (See rating plate on underside of appliance.)
- Never allow the mains lead to come into contact with hot parts!
- Never pull the plug from the socket by means of the mains lead!
- Do not use the appliance if:
 - the mains lead is damaged,
 - the casing shows signs of damage
- Never put water into the appliance when it is hot! Switch the coffee machine off and leave it to cool for approx. 5 mins!
- Follow the instructions on descaling!
- Prior to carrying out maintenance or cleaning, ensure that the appliance is switched off and unplugged from the mains!
- Do not submerge the base unit in water!
- If it should be necessary to repair the coffee machine or replace the mains lead, please send the appliance either to the specialist dealer you bought it from (special tools must be used for repairs), or to your nearest AEG customer service centre (see back page). Electrical appliances may only be repaired by trained technicians. **Improper repairs can give rise to significant hazards for the user. No responsibility can be accepted for damage to appliances that have not been used correctly or for the correct purpose.**

Technical Data





Power consumption: 1000 W
Mains voltage: 230 V

- CE** This appliance complies with the following EC directives:
- 73/23/EEC dated 19.02.1973 "Low Voltage Directive", including Amending Directive 93/68/EEC
 - 89/336/EEC dated 03.05.1989 "EMC Directive", including Amending Directive 92/31/EEC

Carbon Filter System (Figure 3)

Your coffee machine is fitted with a carbon filter. This carbon filter helps to remove the majority of such elements as chlorine from tap water that might otherwise spoil the flavour. This allows the full flavour of your coffee to develop.

Inserting and Changing the Carbon Filter (Figure 4)

-  Remove the carbon filter provided from its plastic packaging and rinse thoroughly under running water.
-  Raise the lid above the water tank (Figure 1/A).
-  Insert the carbon filter (Figure 3/B) in the filter holder (Figure 3/C). Ensure that the carbon filter is fully and correctly in place!
-  Attach the filter holder handle (Figure 3/A) firmly to the filter holder (Figure 3/C).
-  Insert the complete carbon filter system into the recess in the water tank (Figure 4).

The tap water will be filtered during the brewing procedure. **Please note that the carbon filter must be replaced either after 60 brewing procedures or after 6 weeks (whichever is the sooner) so that the filtering will continue to be effective. The old carbon filter cannot be cleaned and must be replaced with a new one.**

Important: Regardless of how frequently the coffee machine is used the carbon filter must be changed **the latest after six months** to avoid a build up of bacteria in the filter.

Spare Parts/Accessories

New carbon filters may be obtained from a specialist dealer (E No. 900 084 952) or from your nearest AEG customer service centre (ET No. 900 084 952/2).

If the coffee jug is broken, a replacement may be ordered from customer service under the following order numbers:

- Coffee jug, colour caramel, ET No. 400 606 677/5 for KF 2060
- Coffee jug, colour blue, ET No. 400 606 680/9 for KF 2061
- Coffee jug, colour black, ET No. 400 607 614/7 for KF 2062.



Cord Compartment (Figure 5)

Your coffee machine has a cord compartment. Surplus cord may be stored in the base of the casing.

Before Using for the First Time

Before brewing coffee for the first time, you should carry out one or two brewing procedures with water only, but with the full quantity of water:

1. to clean the coffee machine;
2. a new carbon filter will discolour the water on the first run through. This does not, however, affect the flavour of the coffee.

-  Fill the fresh water container to the top cup marking with cold water.
-  Switch the appliance on and allow the water to run through into the coffee jug. Do not use ground coffee or a filter paper.
-  Throw away the water that has run through.

Making Coffee

Filling with water (Figure 6)

- ☞ Raise the lid above the water tank (Figure 1/A). Fill the water tank with clear, cold tap water. Never use hot water. Please do not put milk, prepared coffee, tea etc., into the water tank. You can use the coffee jug to pour in the required amount of water. The water level gauge is on the outer side of the water tank (Figure 1/D). The markings apply to the quantity of fresh water. The amount of coffee produced will be less as the ground coffee absorbs water.

- ☞ Close the water tank lid.

Inserting filter paper (Figure 7)

- ☞ Place size 4 filter paper in the filter insert. First fold the perforated sides.

Put in ground coffee (Figure 8)

Please use – “medium” ground coffee. The amount of ground coffee used depends on taste. One measuring spoon full (approx. 6-7 g) per cup is sufficient for a medium strength coffee.

Placing the coffee jug on the warming plate

- ☞ Place the coffee jug on the warming plate. Ensure that the coffee jug is correctly positioned as the anti-drip valve will not open until the jug is in place (see Figure 9).

The anti-drip valve prevents drips falling onto the warming plate if the jug is removed when brewing is still in progress. It is essential that the jug is returned within 30 seconds as otherwise the filter will overflow.

The warming plate keeps the coffee at a constant drinking temperature. It continues to function until you switch off the appliance and the indicator goes out. If you forget to switch the coffee machine off manually, your appliance will switch off automatically after approx. 2 hours (not KF 2060).

To obtain an evenly strong coffee, stir it in the coffee jug after preparation.

Switching the Appliance On (according to model)

KF 2060 (Figure 2a)

- ☞ Press the on/off button (Figure 2a/ A). The indicator (red) (Figure 2a/B) is illuminated and the brewing procedure will start.

Once the brewing procedure is complete and you no longer require the warming plate function, switch the appliance off by again pressing the on/off button. The indicator will go out.

KF 2061 Aroma (Figure 2b)

- ☞ Press the on/off button (Figure 2b/A). The indicator (red) (Figure 2b/B) is illuminated and the brewing procedure will start.

Preparing small quantities of coffee (2-4 cups)

Your coffee machine is fitted with an aroma button (Figure 2b/C). The aroma setting guarantees full coffee enjoyment even with small quantities (2-4 cups).

- ☞ Press the aroma button (Figure 2b/C). The display (green) for 2-4 cups (Figure 2b/D) is illuminated.

- ☞ Press the on/off button (Figure 2b/A), to start the brewing procedure. The indicator (red) (Figure 2b/B) is illuminated and the brewing procedure will start.

The selected quantity “2-4 cups” can be cancelled by pressing the aroma button again or by pressing the on/off button.

Once the brewing procedure is complete and you no longer require the warming plate function, switch the appliance off by again pressing the on/off button. The indicator will go out.

Auto shut off

Your coffee machine has a safety cut-out. If the appliance is not used for 2 hours after the brewing procedure has started, it switches off automatically for safety reasons and also to save energy. The indicator (red) will go out (Figure 2b/B)

KF 2062 Timer (Figure 2c)

- ➡ Press the on/off button (Figure 2c/G). The indicator (red) (Figure 2c/F) is illuminated and the brewing procedure will start.

Preparing small quantities of coffee (2–4 cups)

Your coffee machine has an aroma button (Figure 2c/J). The aroma setting guarantees full coffee enjoyment even with small quantities (2–4 cups).

- ➡ Press the aroma button (Figure 2c/J). The symbol ☐ will appear in the display (Figure 2c/A). To cancel the selected quantity 2–4 cups, press the aroma button again. The symbol ☐ will go out in the display. Start and end the brewing procedure as described above.

Preparing coffee using the timer

Your appliance has a timer with which you can programme the start of the brewing procedure up to 24 hours in advance.

First set the current time. The display (Figure 2c/A) will flash "00:00".

- ➡ Press the button for HOURS (Figure 2c/B) for approx. 2 seconds and hold it down until the correct time is shown in the display (Figure 2c/A).
- ➡ Press the button for MINUTES (Figure 2c/C) and proceed as for setting the hours.
Set the time at which you wish the brewing procedure to start.
- ➡ Press the programme button (Figure 2c/H).
- ➡ Press the button for HOURS (Figure 2c/B) and set the hours.
- ➡ Press the button for MINUTES (Figure 2c/C) and set the minutes.
- ➡ Press the AUTO-START button (Figure 2c/D).

The display for AUTO-START (Figure 2c/E) is illuminated. The programmed start time will go out in the display and the current time will reappear.

The brewing procedure will start automatically at the starting time you have programmed. The indicator (red) (Figure 2c/F) is illuminated.

To check the programmed start time, press the programme button (Figure 2c/H). The start time will appear in the display (Figure 2c/A). After a few seconds it will go out and the current time will reappear.

If you wish to cancel the selected start time, press the button for AUTO-START (Figure 2c/D). The green display for AUTO-START (Figure 2c/E) will go out.

Important: If there is a brief power failure of up to 5 seconds the data remains stored. In the event of a longer power failure the entered data is erased and the time and start time must be reprogrammed as described above.

Important: Once a start time has been programmed, your coffee machine will automatically start a brewing procedure every 24 hours as long as the display (green) for AUTO-START (Figure 2c/E) is illuminated.

You can also use the "2–4 cups" aroma function when a start time is programmed!

- ➡ Once the brewing procedure has been completed and you no longer require the warming plate function, switch the appliance off by pressing the on/off button again. The indicator will go out.

Auto shut off

Your coffee machine has a safety cut-out. If the appliance is not used for 2 hours after the brewing procedure has started it switches off automatically for safety reasons and also to save energy. The indicator (red) (Figure c/F) will go out.

Cleaning the Coffee Machine

- ☞ Remove the filter basket (Figure 1/J) to clean. It is particularly important to activate the anti-drip valve as it is rinsed so that coffee particles are removed thoroughly.

Clean the appliance casing with a damp cloth, but **never immerse it in water!** You can wash the coffee jug and lid in a dishwasher.

Descaling

The service life of your coffee machine can be lengthened with regular descaling. As a precaution we recommend descaling every three months.

Important: If you have a permanent filter, remove it from the filter insert before descaling.

Important: Remove the complete carbon filter system (Figure 3) before you start descaling.

For descaling use a liquid, environmentally-friendly descaling agent available generally at retail outlets. Only use it in accordance with the manufacturer's instructions. Do not use a formic acid based descaler.

- ☞ First fill the fresh water container with water. Then add the appropriate amount of descaling agent – **not** the other **way** round!
- ☞ Place the coffee jug on the warming plate. Please note that positioning the coffee jug correctly opens the anti-drip valve, enabling the water to flow through correctly.
- ☞ Allow the descaling solution to take effect for approx. 15 minutes, then switch the appliance on using the on/off button. Once the descaling solution has run through, switch the appliance off.
Repeat the procedure at least twice using clear water.

- ☞ Rinse the coffee jug, jug lid and filter basket thoroughly under running water. Activate the filter valve several times as it is rinsed.
If necessary, repeat the descaling procedure.

Protecting the Environment

Do not simply throw packaging material away.

- The cardboard box can be deposited in the old paper collection or the relevant refuse collection system.
- Deposit plastic bags made from polyethylene (PE) at a PE collection point for recycling.
- Foam polystyrene (PS) padding items are free of CFCs.
Please inquire with your local authority about your local recycling centre.
After the coffee has been prepared, the paper filter and coffee grounds make excellent compost.

Customer Service

Our products are of the highest quality. Should you nevertheless have questions concerning the use of this appliance, please write to us. Only with your support can we be sure to develop appliances to suit your needs.

Garantiebedingungen

AEG Kundendienst in Deutschland

Sollte dieses AEG Gerät wider Erwarten nicht funktionieren, wenden Sie sich bitte an unseren Service. Wir werden die Abholung und Instandsetzung durch unsere Werkstatt veranlassen.

AEG Kleingeräte-Zentralwerkstatt
Firma Trepesch GmbH
Steinstraße 500
90419 Nürnberg

In **Deutschland** stehen wir Ihnen für Fragen, Anregungen oder bei Problemen rund um unsere Kleingeräte und Raumpflegergeräte montags bis freitags von 8 bis 18 Uhr zur Verfügung.

AEG-ServiceLine: 01805-30 60 80
(Deutsche Telekom 0,12 Euro/Min.)
Fax: 0911/ 3 23-49 19 30
E-Mail: service.kleingeraete@aeg-hausgeraete.de

AEG Kundendienst in Europa

In diesen Ländern gelten die Garantiebedingungen der örtlichen Vertriebsorganisationen. Diese können dort eingesehen werden.

In these countries our AEG sales organisations own guarantee conditions are applicable. Please obtain further details direct.

Österreich, 4010 Linz, 0732 / 770101 – 30
Belgique/België, 1502 Lembeek, 02/363.04.44
Czech Republic, Hanusova ul., Praha 4, 02/6112 6112
Danmark, 7000 Fredericia, 70 11 74 00
España, Madrid, 1-885-2700
France, 60307 Senlis, 03-44 62 24 24
Great Britain, Service Force 08705 929 929
Hellas, 18346 ΜΟΞΑΤΟ, 01/4822646
Island, Reykjavik (Bræuurnir Ormsson hf), 91-3 88 20
Italia, 33080 Porcia (PN), 0434 39 41
Kroatien, 10000 Zagreb, 385 1 6323 333
Luxembourg, 1273 Luxembourg-Hamm, 4 24 31-443
Magyarország, 1142 Budapest, 36-1-252-1773
Niederland, 2400 AC Alphen aan den Rijn, 0172-468 300
Norge, 0516 Oslo, 22 72 58 00
Poland, 02-034 Warszawa, 022 874 33 33
Portugal, 2635-445 Rio de Mouro, (21) 926 75 75
Romania, Bucuresti, B-dul Timisoara 90, 01-444-25-81
Russia, 129090 Moscow, +7 095 956 2917, 937 7893
Slovakia, 81105 Bratislava, 07/4333 9757
Slovenija, Tražaška 132, 1000 Ljubljana, 01 24 25 730
Schweiz/Svizzera, 5506 Mägenwil, 062/889 93 00
Suomi, Porissa, puh. (02) 622 3300
Sverige, 10545 Stockholm, 08-672 53 60
Turkey, Tarlabasi cad no:35 Taksim/Istanbul-0, 262-7249420

Der Endabnehmer dieses Geräts (Verbraucher) hat bei einem Kauf dieses Geräts von einem Unternehmer (Händler) in Deutschland im Rahmen der Vorschriften über den Verbrauchsgüterkauf gesetzliche Rechte, die durch diese Garantie nicht eingeschränkt werden. Diese Garantie räumt dem Verbraucher also zusätzliche Rechte ein. Dies vorausgeschickt, leisten wir, AEG Hausgeräte GmbH, gegenüber dem Verbraucher **Garantie für dieses Gerät für den Zeitraum von 24 Monaten ab Übergabe** zu den folgenden Bedingungen:

1. Mit dieser Garantie haften wir dafür, dass dieses neu hergestellte Gerät im Zeitpunkt der Übergabe vom Händler an den Verbraucher die in unserer Produktbeschreibung für dieses Gerät aufgeführten Eigenschaften aufweist. Ein Mangel liegt nur dann vor, wenn der Wert oder die Gebrauchstauglichkeit dieses Geräts erheblich gemindert ist. Zeigt sich der Mangel nach Ablauf von sechs (6) Monaten ab dem Übergabezeitpunkt, so hat der Verbraucher nachzuweisen, dass das Gerät bereits im Übergabezeitpunkt mangelhaft war. Nicht unter diese Garantie fallen Schäden oder Mängel aus nicht vorschriftsmäßiger Handhabung sowie Nichtbeachtung der Gebrauchsanweisungen.
2. Dieses Gerät fällt nur dann unter diese Garantie, wenn es in einem der Mitgliedsstaaten der Europäischen Union gekauft wurde, es bei Auftreten des Mangels in Deutschland betrieben wird und Garantieleistungen auch in Deutschland erbracht werden können. Mängel müssen uns inner-

halb von zwei (2) Monaten nach dessen Kenntnis angezeigt werden.

3. Mängel dieses Geräts werden wir innerhalb angemessener Frist nach Mitteilung des Mangels unentgeltlich beseitigen; die zu diesem Zweck erforderlichen Aufwendungen, insbesondere Arbeits- und Materialkosten werden von uns getragen. Über diese Nachbesserung hinausgehende Ansprüche werden durch diese Garantie dem Verbraucher nicht eingeräumt.
4. Im Garantiefall ist das Gerät vom Verbraucher an die für seinen Wohnort zuständige AEG-Zentralwerkstatt zu versenden, wobei das Gerät gut zu verpacken ist und die vollständige Anschrift des Verbrauchers zusammen mit einer kurzen Fehlerbeschreibung in das Paket zu legen ist. Zum Nachweis des Garantie-Anspruchs ist der Sendung der Original-Kaufbeleg (Kassenzettel, Rechnung) beizufügen.
5. Garantieleistungen bewirken weder eine Verlängerung noch einen Neubeginn der Garantiezeit für dieses Gerät; ausgewechselte Teile gehen in unser Eigentum über.
6. Mängelansprüche aus dieser Garantie verjähren in zwei (2) Jahren ab dem Zeitpunkt der Übergabe des Geräts vom Händler an den Verbraucher, der durch den Original-Kaufbeleg (Kassenzettel, Rechnung) zu belegen ist; wenn dieses Gerät gewerblich genutzt wird, beträgt die Verjährungsfrist sechs (6) Monate.

AEG Hausgeräte GmbH
Postfach 1036
D-90327 Nürnberg

<http://www.aeg.hausgeraete.de>

© Copyright by AEG

822 949 140 - 02 - 0203