

# **AVE DR16X / AVE DR8X Series**

## **Full-Featured MPEG-4 DVR**

### **User's Manual**

Ver. 1.4



## Caution and Preventive Tips

- Take care not to drop the unit or subject the unit to major shocks or jolts.
- Do not place this unit on an unstable stand, bracket or mount.
- This unit is designed for indoor use only. Do not place the unit near water or in other extremely humid conditions.
- This unit should not be placed in a built-in installation unless proper ventilation is provided.
- Please check the used type of power source before you plug and operate the unit.
- If the clearing is necessary, note to plug the unit from the outlet before uncovering the top cover. Do not use liquid cleaners or aerosol cleaners. Use only a damp cloth for cleaning.
- Always power down the system prior to connecting and disconnecting accessories, with the exception of USB devices.
- Lithium battery: Danger of explosion if battery is incorrectly replaced. Replace with the same or equivalent type recommended by the battery manufacturer. Dispose of used batteries according to the battery manufacturer's instructions.
- Do not block the fan on the bottom of the unit for air ventilation.

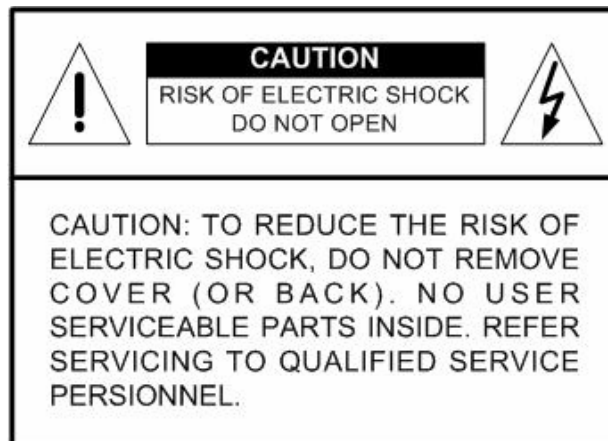

This symbol intends to alert the user to the presence of important operating and maintenance (servicing) instructions in the literature accompanying the appliance.



This symbol intends to alert the user to the presence of unprotected "Dangerous Voltage" within the product's enclosure that may be strong enough to cause a risk of electric shock.

## **Important Information**

Before proceeding, please read and observe all instructions and warnings in this manual. Retain this manual with the original bill of sale for future reference and, if necessary, warranty service. When unpacking your unit, check for missing or damaged items. If any item is missing, or if damage is evident, **DO NOT INSTALL OR OPERATE THIS PRODUCT**. Contact your dealer for assistance.

## **Rack Mounting**

Consult with the supplier or manufacturer of your equipment rack for the proper hardware and procedure of mounting this product in a safe fashion. Avoid uneven loading or mechanical instability when rack-mounting units. Make sure that units are installed to get enough airflow for safe operation. The maximum temperature for rack-mounted units is 40 °C. Check product label for power supply requirements to assure that no overloading of supply circuits or over current protection occurs. Mains grounding must be reliable and uncompromised by any connections.

## Table of Content

|   |           |
|---|-----------|
| <b>1. Overview .....</b>                                  | <b>6</b>  |
| 1.1 Product Key Features .....                            | 6         |
| 1.2 Product Application Diagram.....                      | 8         |
| <b>2. System Setup.....</b>                               | <b>8</b>  |
| 2.1 Position the Unit.....                                | 9         |
| 2.2 Selecting Video Format.....                           | 9         |
| 2.3 Connecting Devices to the Unit.....                   | 9         |
| 2.4 Rear Panel Connections .....                          | 10        |
| <b>3. General System Setup .....</b>                      | <b>13</b> |
| 3.1 Front Panel Introduction .....                        | 13        |
| 3.1.1 LED Definition .....                                | 13        |
| 3.1.2 Functional Keys.....                                | 14        |
| 3.2 Install HDD to the Unit .....                         | 17        |
| 3.3 Power Up / Down the Unit .....                        | 18        |
| 3.4 Entering OSD Setup Menu .....                         | 19        |
| 3.5 System Date / Time Setting .....                      | 20        |
| 3.5.1 Set Date / Time.....                                | 20        |
| 3.5.2 Daylight Saving Time.....                           | 21        |
| 3.6 Record Schedule / Quality Setting.....                | 22        |
| 3.6.1 Record Mode.....                                    | 22        |
| 3.6.2 Schedule Setup .....                                | 23        |
| 3.6.3 Preset Record Configuration .....                   | 23        |
| 3.6.4 Per Camera Configuration.....                       | 24        |
| 3.6.5 To Record Event Video Only .....                    | 24        |
| <b>4. Basic Operation.....</b>                            | <b>25</b> |
| 4.1 Viewing Live / Playback Video .....                   | 25        |
| 4.1.1 Viewing Modes .....                                 | 25        |
| 4.1.2 Digital Zoom .....                                  | 26        |
| 4.1.3 Viewing Live Cameras.....                           | 26        |
| To Freeze Live Image.....                                 | 26        |
| 4.1.4 Viewing Recorded Video .....                        | 26        |
| Key Usage in Playback .....                               | 27        |
| Pause Playback and Single Step Forward .....              | 27        |
| Viewing Live Image in Playback Mode.....                  | 28        |
| 4.1.5 Dual Main Output (For Unit with Turbo Module) ..... | 28        |
| 4.2 Sequence Setup .....                                  | 29        |

---

|   |  |           |
|---|--|-----------|
| 4.2.1   | Sequence with Main Monitor .....             | 29        |
| 4.2.2   | Sequence with Call Monitor .....             | 29        |
| 4.3   | Searching Recorded Video .....               | 30        |
| 4.3.1   | Searching by Time .....                      | 31        |
| 4.3.2   | Searching by Event .....                     | 31        |
| 4.4   | Video Export .....                           | 32        |
| 4.4.1   | Export from OSD Setup Menu .....             | 32        |
| 4.4.1.1   | Select the External Device .....             | 33        |
| 4.4.1.2   | Select Video for Exporting .....             | 34        |
| 4.4.1.3   | Digital Signature .....                      | 35        |
| 4.4.1.4   | Erase Disc .....                             | 35        |
| 4.4.2   | Quick Video Export through Front Panel ..... | 35        |
| 4.4.2.1   | ezBurn Introduction .....                    | 36        |
| 4.4.2.2   | To Export Normal Video .....                 | 36        |
| 4.4.2.3   | To Export Event Video .....                  | 37        |
| 4.5   | Deleting Recorded Video .....                | 38        |
| 4.6   | Dome Control .....                           | 38        |
| 4.6.1   | Dome Connection .....                        | 39        |
| 4.6.2   | Dome Protocol Setup .....                    | 39        |
| 4.6.3   | RS485 Setup .....                            | 40        |
| 4.6.4   | Dome Controlling Key .....                   | 41        |
| 4.6.5   | Setting Preset Points .....                  | 42        |
| 4.6.6   | Calling Preset Points .....                  | 43        |
| <b>Appendix A: Technical Specifications .....</b> |  | <b>44</b> |

## 1. Overview

The **AVE DR16X / AVE DR8X** series unit is an integrated digital video recorder that combines the features of a time-lapse audio / video recorder, a multiplexer, and a video server to create a single security CCTV solution.

Its outstanding triplex+ operation enables users to view live or playback recorded video, and remote access through network simultaneously, while recording other video, and to view wanted recorded video instantly by entering the time and date or selecting recorded video from the event list.

**AVE DR16X / AVE DR8X** series includes **DVRRemote**, the remote viewing and configuration software that is a Web-browser plug-in, allows user to view live or recorded video images and enables remote configuration. The remote software is stored in **AVE DR16X / AVE DR8X** series and deployed over a LAN, WAN or Internet connection to remote Windows-based computers. This simplifies the installation and maintenance of the software components so all remote users are kept up to date.

Below lists the front panels of **AVE DR16X / AVE DR8X** series family, the difference between the three models is the total recording number of images per second.



**NOTE:** Use of other power supply may cause overloading.

### 1.1 Product Key Features

The **AVE DR16X / AVE DR8X** series offers advanced features not typically found in standard multiplexers; it integrates the full features of a DVR, multiplexer and video server (by using the software **DVRRemote**). The key features of **AVE DR16X / AVE DR8X** series are listed as follows.

- MPEG-4 high quality compression
- 16 channels video input
- Triplex+ operation enabling simultaneous viewing live or playback while continuing to record
- **DVRRemote** web-based software for remote monitoring and control via LAN or Internet
- Embedded Linux operating system

- Real-time “live display” for each channel
- Recording frame rate up to 480 pps (NTSC) / 400pps (PAL)
- 2 Channels of audio recording/ playback
- Three USB2.0 ports for video clip export and/or backup
- Easy software upgrade via USB ThumbDrive®, DVD+RW, or Internet Remote Application
- Up to 4 internal hard disk drives support up to 1TB capacity
- Hard disk drive full alarm for noticing
- 2X Digital Zoom available in live mode
- Export video (AVI & DRV) with audio and digital Signature
- Exported AVI file can be played in any PC with DivX decoder installed
- Automatic camera detection (Plug & Play)
- Covert camera operation provides enhanced security and administrator control
- Per camera configuration for camera settings, frame rate, picture bit rate, alarms, motion detection.
- Programmable day/ night/ weekend scheduling
- Programmable main monitor/ call-monitor switching sequence
- Dual video out for monitoring
- Powerful alarm processor allows flexible alarm trigger and responses, including alarm, motion, and camera failure
- Text Message (Short Message Service; SMS) sent to your mobile phone for alarm notice.
- Dome control protocols: DynaColor, Pelco D, Pelco P,AD422 and Fastrax 2.
- Pre-program the OSD menu using a mouse connected to the USB port
- Supports multiple language on-screen menus
- Two levels of password security
- Universal power input, no external power unit.



## 1.2 Product Application Diagram

Connect the unit with other devices as shown in the system diagram to complete a video surveillance solution. The figure shows also the expandability and flexibility of this digital recording system.

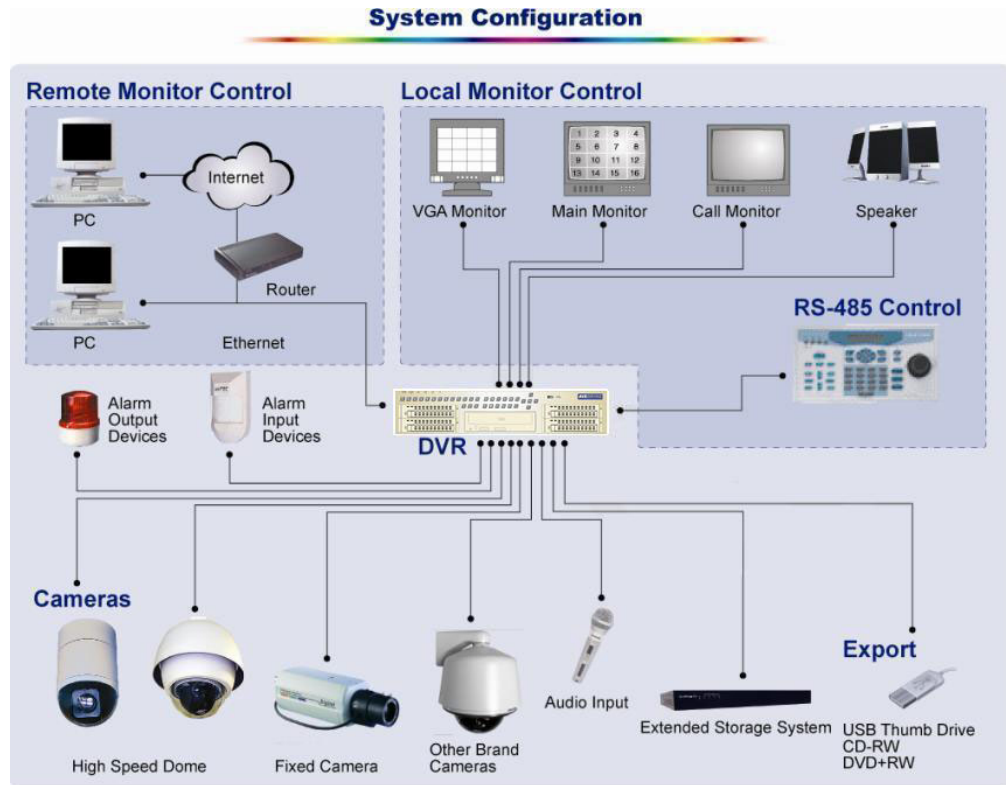

## 2. System Setup

The notices and introduction on system installation will be described particularly in this chapter. Please follow the description to operate the unit.

In order to prevent the unit from data loss and system damage that caused by a sudden power fluctuation, use of an Uninterruptible Power Supply (UPS) is highly recommended



**NOTE:** These HDD CANNOT be hot-swapped in any case. And remember to set the upper two HDDs to "Master", or the HDDs may not be detected.

## 2.1 Position the Unit

Firstly, note to position / mount the **AVE DR16X / AVE DR8X** series unit in a proper place and be sure to power off the unit before making any connections. The placed location should avoid hindering or blocking the unit from airflow. Enough airflow is needed to protect the unit from overheating. The maximum allowable temperature of operating environment is 40°C.

The unit utilizes heat-conducting techniques to transfer internal heat to the case, especially to the bottom side of the unit.



**NOTE:** Be sure not to remove the rubber feet, and always leave a space for air ventilation on the unit's bottom side.

## 2.2 Selecting Video Format

The **AVE DR16X / AVE DR8X** series unit is designed to operate under either NTSC or PAL video formats. The switch is positioned on the rear panel.



## 2.3 Connecting Devices to the Unit

This section lists some notices that should be given before making any connections to the **AVE DR16X / AVE DR8X** series unit.



**NOTE:** Connect short-term devices, such as USB ThumbDrive®, USB CD-RW, USB Hard Disk Drive, etc., only after the unit is successfully powered up.

### **Connecting Required Devices**

Before power up the unit, you should connect cameras and a main monitor to the unit for basic operation. If needed, connect a call monitor for displaying full screen video of all installed cameras in sequence.

**Connecting Short-term Device**

If you plan to install any short-term devices to the **AVE DR16X / AVE DR8X** series and use them as part of the unit system, such as USB CD-RW, USB Hard Disk Drive, etc. Make sure connecting those devices only during the unit is powered up. Because **AVE DR16X / AVE DR8X** series unit can recognize the external devices only after the power-up process is done completely.

**2.4 Rear Panel Connections**

There are various connectors on the rear panel used for **AVE DR16X / AVE DR8X** series installations. The following figure shows the connectors by name; and followed by the detailed description of each connector.

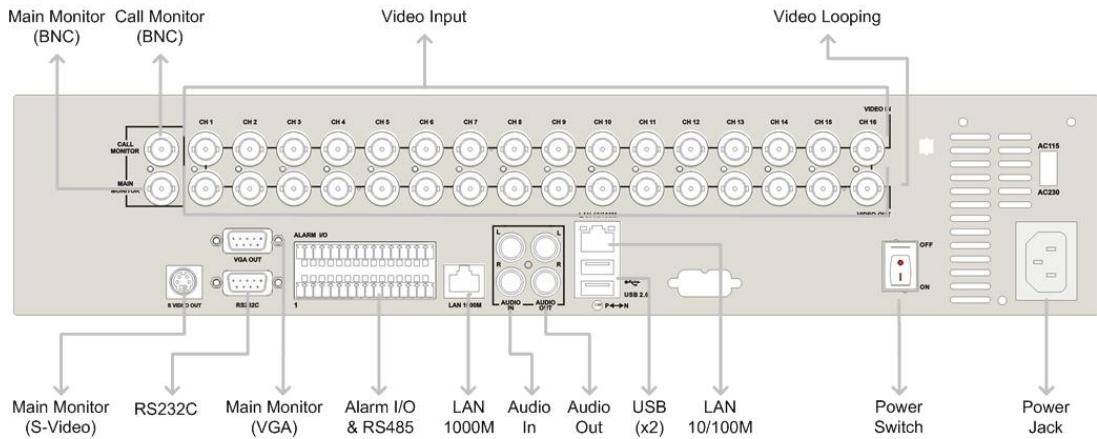

**Main Monitor (S-Video / BNC)**

Both S-Video and BNC output connectors are offered for connecting to a main monitor. The main monitor displays live image and playback recorded video in full-screen or split-window format.

**Call Monitor (BNC)**

The call monitor is used to display full screen video of all installed cameras in sequence. The BNC call monitor connector allows user to connect the **AVE DR16X / AVE DR8X** series unit with an optional call monitor.

**Video Input**

16 BNC connectors are offered for video input streams from installed cameras. The number of connectors is equal to the number of channels.

### **Camera Looping**

Plenty of BNC connectors are positioned on the rear panel for looping out the video input.

### **LAN Connector (RJ-45)**

The **AVE DR16X / AVE DR8X** series is capable of networking. The LAN port opens the door of **AVE DR16X / AVE DR8X** series to Ethernet where by the Internet.

### **Power Jack**

The **AVE DR16X / AVE DR8X** series has an adjustable voltage AC 115 / 230 power connection jack. Before you connect to a power supply, please note that the switch is set to the appropriate setting. Please connect the power supply that ships with the unit.

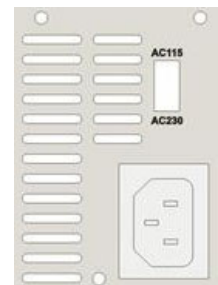

**NOTE:** Use of other power supply may cause overloading.

### **Power Switch**

Used to power up and shut down the unit.

### **Audio In / Out115 /**

The **AVE DR16X / AVE DR8X** series unit provides two channels of audio recording and playback. Audio In RCA connector is offered for connecting an audio source device (e.g. external amplified microphone) to the unit; Audio Out RCA connector is offered for connecting an audio output device (e.g. amplified speakers) to the unit.

**Alarm I/O & RS485**

The unit provides an alarm I/O and RS485 port that offers user the flexibility required to connect the unit to the other device.

| <b>Pin</b> | <b>Definition</b> | <b>Pin</b> | <b>Definition</b> |
|------------|-------------------|------------|-------------------|
| <b>1</b>   | Ground            | <b>17</b>  | Alarm In 1        |
| <b>2</b>   | Normal Close 1    | <b>18</b>  | Alarm In 2        |
| <b>3</b>   | Common Node 1     | <b>19</b>  | Alarm In 3        |
| <b>4</b>   | Normal Open 1     | <b>20</b>  | Alarm In 4        |
| <b>5</b>   | Ground            | <b>21</b>  | Alarm In 5        |
| <b>6</b>   | Normal Close 2    | <b>22</b>  | Alarm In 6        |
| <b>7</b>   | Common Node 2     | <b>23</b>  | Alarm In 7        |
| <b>8</b>   | Normal Open 2     | <b>24</b>  | Alarm In 8        |
| <b>9</b>   | Ground            | <b>25</b>  | Alarm In 9        |
| <b>10</b>  | Normal Close 3    | <b>26</b>  | Alarm In 10       |
| <b>11</b>  | Common Node 3     | <b>27</b>  | Alarm In 11       |
| <b>12</b>  | Normal Open 3     | <b>28</b>  | Alarm In 12       |
| <b>13</b>  | Ground            | <b>29</b>  | Alarm In 13       |
| <b>14</b>  | RS485 D+          | <b>30</b>  | Alarm In 14       |
| <b>15</b>  | RS485 D-          | <b>31</b>  | Alarm In 15       |
| <b>16</b>  | Ground            | <b>32</b>  | Alarm In 16       |

**VGA Out**

A VGA output connector is offered for connecting to a VGA main monitor. The source of image of VGA and BNC main monitor are the same.

**RS-232C**

The unit provides a RS-232C communication port for sending and receiving signals.

**USB Connector (x2)**

There are two USB2.0 ports on the rear panel for users to connect external USB devices to the unit, such as ThumbDrive® or CD-RW.

**AVE DR16X / AVE DR8X** series unit allows users to preset the OSD settings using a USB mouse.

### 3. General System Setup

The **AVE DR16X / AVE DR8X** series DVR allows user to access some general operations through the front panel easily. The following subsections introduce the general operations of the unit.

The regular displayed OSD information and its displayed positions are shown as following figure. The channel title will be displayed on the top-left side of the window, either in full screen mode or in multiple channel mode. The current operating mode, including Call mode, Dome-Control mode, Playback mode. Freeze mode and Sequence mode, will be displayed on the bottom-left side of the screen. And the date/ time information will be display on the bottom-right side.

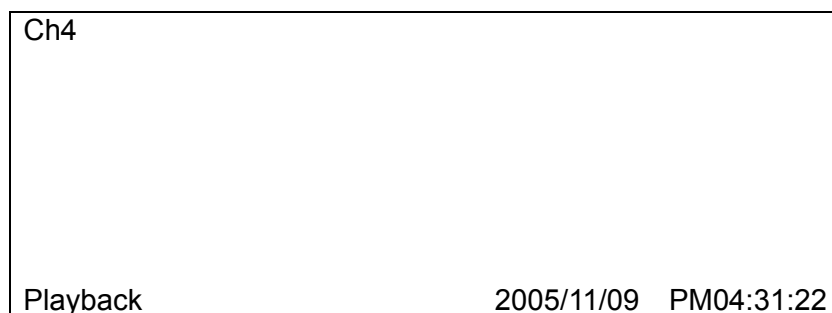

### 3.1 Front Panel Introduction

The unit's front panel controls enable user to control the unit and preset the programmable functions.

#### 3.1.1 LED Definition

The **AVE DR16X / AVE DR8X** series LEDs on the front panel are described as follows.

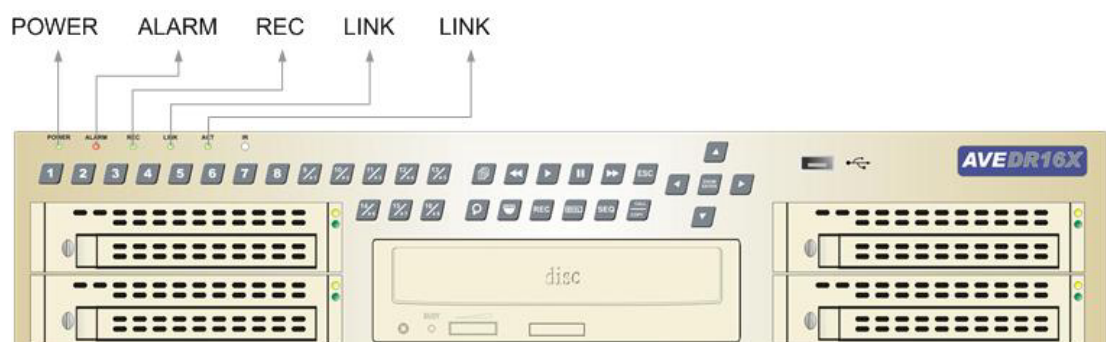

**Power LED (Green)**

The LED lit during the period when the correct power is connected to the unit.

**HDD LED (Yellow)**

The LED should be lit while the HDD is processing data to or from the connected HDD.

**Alarm LED (Red)**

The LED should be lit during an alarm is triggered.

**Network LED (Green)**

The LED should be lit when **AVE DR16X / AVE DR8X** series is connected to a network and blink when the data is being transferred.

**REC LED (Green)**

The LED should blink while the **AVE DR16X / AVE DR8X** series is recording.

### 3.1.2 Functional Keys

The **AVE DR16X / AVE DR8X** series functional keys on the front panel for normal operation are described as follows.

**CHANNEL**

- Under both Live and Playback modes, press the CHANNEL key to view the corresponding video in full screen. The number of the CHANNEL keys corresponds to the number of cameras supported by the unit.
- Under Dome Control Mode, press 9 ~ 16 to go to preset points, respectively.
- Under dome control mode, the key named “1” is used to access the Set/Go preset menu; the key named “2” is used to hide or display the dome setting parameters.

**MENU**

Press the key to call the OSD setup menu.

**Fast Rewind**

Under Playback mode, press this key to playback the video backward. Press repeatedly to choose the speed from: 1x, 2x, 4x, 8x, 16x, and 32x,

**PLAY/STOP**

Press this key to switch between live image and playback video.



**NOTE:** The video of latest 5 ~ 10 minutes cannot be played back, because the video is still saved in the buffer.

**FREEZE**

- Press FREEZE while viewing live image, the live video will be frozen. The date / time information shown on the monitor will continue updating. Press FREEZE again to return to live mode.
- Press FREEZE while playing the recorded video, the playback video will be paused. Press LEFT / RIGHT to move the recorded video reverse / forward by single step. Press FREEZE again to continue playing video.

**Fast Forward**

Under Playback mode, press this key to playback the video backward. Press repeatedly to choose the speed from: 1x, 2x, 4x, 8x, 16x, and 32x,

**ESC**

- Press to cancel or exit from certain mode or OSD menu without changing the settings made previously.
- This key allows you to enable the key lock function.

If the password protection has been enabled, press ESC for two seconds to lock up the function of certain keys on the front panel, including PLAY, MENU, SEARCH, CALL and DOME. Once you lock up the function of these keys, you have to enter the correct password before accessing the functions of these keys. The unlocking duration will list for 5 minutes, then these keys will go back to locked mode.



If the password protection hasn't been enabled, press ESC for two second to lock/ unlock the functions of these keys.



**NOTE:** Please go to the <Password> menu to enable or disable the password protection.



### **SEARCH**

In both Playback and Live mode, user can press SEARCH to call the Search menu for searching and playing back recorded video by date and time or events.



### **DOME**

Press the key to enter dome control mode. Please refer to OSD Menu Setup Guide, Section Dome Control for detailed controlling operation.



### **Instant Record**

Press to start instant recording, press again to stop recording and return to previous status.



### **MODE**

Press repeatedly to select for wanted main monitor display format. There are three available view modes: full screen, 4-window (2x2) and 16-window (4x4). Refer to OSD Menu Setup Guide, Section Viewing Modes for detailed information.



### **SEQ (Sequence)**

Press to start automatic sequencing of the video coming from the installed cameras.



### **Call/ Copy**

- In Live mode, press to enter call monitor control mode.
- In Playback mode, press to quick export video to external device, including USB CD-RW and ThumbDrive<sup>®</sup>, etc. Detailed operation refer to OSD Menu Setup Guide, Section Quick Video Export through Front Panel.



### **Direction Keys**

- In Zoom mode, these keys function as Direction keys.
- In the OSD setup menu, the Direction keys are used to move the cursor to previous or next fields. To change the value in the selected field, press UP / DOWN keys.



### **ZOOM/ENTER**

- In OSD menu or selection interface, press the key to make the selection or save settings.
- In live full screen view mode, press to view a 2x zoom image; press it again to return.

## **3.2 Install HDD to the Unit**

There is a cartridge positioned on the front panel, and it allows user to install a swappable HDD. There will be two possible situations when you install a HDD into your DVR.

- If you install whole new HDDs, the DVR will format it and add it into your database automatically.
- If you install an used HDD which doesn't have the DVR format, the DVR will show up "1 disk(s) with wrong data format! Please format them and then add to the database manually". Then please follow the steps as we describe below:
  - Please enter the menu with the administrator privilege and access the "Database Information" section
  - Please access the "Internal(or external) Disks"
  - You can see the available disks, please select "format" to format it
  - After formatting is OK, please select "Add" to add them into your database.

### 3.3 Power Up / Down the Unit

If you must shut down the **AVE DR16X / AVE DR8X** series for any reason, please use the proper shut down and power up procedures to avoid damaging to your DVR unit.

#### **To Power Up the Unit**

Check the used type of power source before plug in your DVR unit first (the acceptable power input is between AC110V ~AC240V), and turn on the unit using the power switch on the rear panel.

The color bar and system checking information will be shown on the monitor and disappear when the unit has been completely powered up.

#### **To Restart / Shutdown the Unit**

To restart/ shutdown the unit, you have to enter the OSD setup menu and select the <Shutdown> menu. Note to enter the OSD setup menu with correct Administrator Password, or, the <Shutdown> menu will be unable to access.

Press MENU and input the administrator password to access the OSD Main menu. Select <Shutdown> in Main Menu and press ENTER to enter the Shutdown menu, which displays as follows.

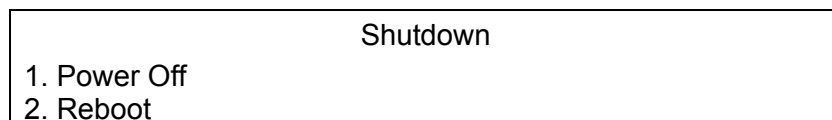

#### **<Power Off>**

Select this item to shut down the unit. Do not remove the power during shut down until the message "You can safely turn off DVR now!" displays.

#### **<Reboot>**

Select this item to reboot the unit. The color bar and system checking information are displayed on the monitor until the unit is completely restarted.

### 3.4 Entering OSD Setup Menu

The OSD Main menu contains a list of items that are used to configure the **AVE DR16X / AVE DR8X** series. To enter the Main menu, press MENU and then enter Administrator or User password. The Password Verification screen displays as follows.

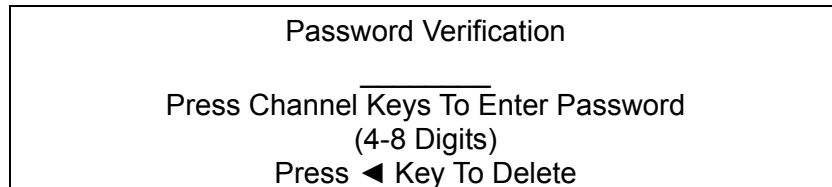

The default passwords are shown in the following table. The same passwords are used for entering the remote viewing software **DVRRemote**.

| Administrator Password | User Password |
|------------------------|---------------|
| 1234                   | 4321          |



**NOTE:** It is strongly suggested to change the passwords to prevent unauthorized access to the unit.

After entering the correct password, the Main menu is displayed.

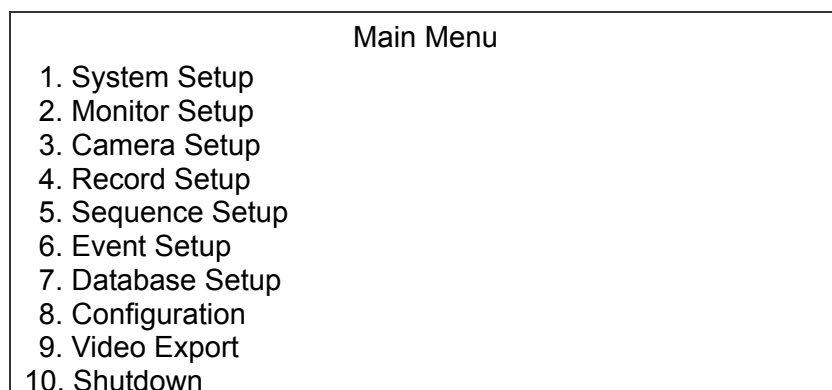

Move the cursor up / down over the OSD items using the Direction keys and press ENTER to enter the selected sub-menu.

### 3.5 System Date / Time Setting

User can set the current date, time and other OSD parameters in Date/Time menu (under System Setup menu). The administrator's privileges are required for entering the submenu. In OSD Main menu, select <System Setup> and press ENTER, then select <Date/Time> to access the Date/Time menu; the menu displays as follows.

| Date/Time               |                      |
|-------------------------|----------------------|
| 1. Date                 | 2005/02/21           |
| 2. Time                 | PM10:39:26           |
| 3. Date/Time Display    | 1 Row                |
| 4. Date Display Mode    | Y/M/D                |
| 5. Time Display Mode    | 24 HR                |
| 6. Date/Time Order      | Date First           |
| 7. Daylight Saving Time | OFF                  |
| 8. DST Start            | Apr, 1 st Sun, 02:00 |
| 9. DST End              | Apr, Last Sun, 02:00 |
| 10. DST Bias            | 60 Min               |

#### 3.5.1 Set Date / Time

##### Set Date / Time

Select <Date> / <Time> and press ENTER for adjusting the settings. LEFT / RIGHT keys are used to move the cursor to previous or next field, ENTER is for selecting, and UP / DOWN are used to change the value in the selected field.



**NOTE:** The reset date / time setting applies to record new video, the date and time of previously recorded video will not be changed.



**NOTE:** If you have to change data/ time settings in any cases, we strongly recommend you to format the HDDs in order to avoid the recorded database corruption.

##### Date / Time Display

Users are allowed to choose to set the date / time OSD displays in 1 or 2 rows. Use the UP / DOWN keys to change the setting. The default is to display the date / time OSD in one row.

### **Date Display Mode**

This function allows user to set the OSD display type of the date / time. There are three options to select from: <Y/M/D>, <M/D/Y> or <D/M/Y>. “Y” represents “Year”, “M” represents “Month” and “D” represents “Day”.

Move to the item and press ENTER, the option starts blinking. Use UP / DOWN keys to change the setting. The default setting is <Y/M/D> in both NTSC / PAL formats.

### **Time Display Mode**

User can choose to set the time format to <12 hour> or <24 hour>. Use the UP / DOWN keys to change the format. The default setting is <24 hour>.

### **Date / Time Order**

The item is used to set the order of date / time display to <Date First> or <Time First>. Use UP / DOWN keys to change the setting.

## **3.5.2 Daylight Saving Time**

### **Daylight Saving Time**

The item is for those people who live in certain regions to observe Daylight Saving Time. Select <ON> to enable, or <OFF> to disable the function.

If the function is disabled, the DST Start / End time and DST Bias will be grayed out and cannot be accessed.



**NOTE:** If this function is enabled, the date/time information will be shown on the screen with a DST icon when playing back recorded video or searching video in the event list. “S” indicates summer time and “W” indicates wintertime.

### **DST Start / End**

The items are used to program the daylight saving duration. Use Direction keys to move the cursor to the next or previous field, UP / DOWN to change the settings in the selected field.

### DST Bias

The item allows user to set the amount of time to move forward from the standard time for daylight saving time. The available options are <30>, <60>, <90> and <120> minutes.

## 3.6 Record Schedule / Quality Setting

The Record Setup menu allows user to set recording quality, recording schedules, and other recording parameters. Administrator's password is required to use Record Setup menu. In the Main menu, move the cursor to <Record Setup> and press ENTER; the following menu is displayed.

| Record Setup           |                |
|------------------------|----------------|
| 1. Record Mode         | 720x240@120PPS |
| 2. Schedule Setup      |                |
| 3. Preset Config       | Standard       |
| 4. Per Camera Config   |                |
| 5. esRecord Setup      |                |
| 6. Data Lifetime       | 0 Days         |
| 7. Pre-Alarm Recording | 15 Sec         |
| 8. Circular Recording  | ON             |
| 9. Audio Recording     | ON             |
| 10. Purge Data         |                |

### 3.6.1 Record Mode

The Record Mode is for selecting resolution and recording rate. The relative record settings, such as preset configuration, will follow the record mode setting. In normal circumstance, we recommend you to select <720 x 240@120PPS> (<720x288@100PPS> in PAL format).

Move the cursor to <Record Mode> and press ENTER, then select a Record mode using UP / DOWN keys.



**NOTE:** After changing the Record Mode setting, the warning message "This will FORMAT ALL HARDDISKS and LOAD THE FACTORY DEFAULT CONFIG!" will be shown on the screen. Press ENTER to confirm the selection, then the unit starts to format the hard disks and load the factory default settings, or press ESC to abort.

We strongly recommend to backed up your programmed configuration before making any changes on Record Mode settings.

## 3.6.2 Schedule Setup

The Schedule Setup is used to set the day and night time, or weekend recording schedule. Select <Schedule Setup> from the Record Setup menu and press ENTER; the following menu is displayed.

| Schedule Setup      |             |
|---------------------|-------------|
| 1. Day Time Start   | AM06:00     |
| 2. Day Time End     | PM06:00     |
| 3. Night Time Start | PM18:00     |
| 4. Night Time End   | AM06:00     |
| 5. Weekend Schedule | YES         |
| 6. Weekend Start    | Fri AM18:00 |
| 7. Weekend End      | Mon PM06:00 |

- Make appropriate changes of the start time of Day and Night Time using Direction keys.
- Press ENTER to confirm the settings or ESC to cancel.
- If you want to have a weekend record, choose <YES> to enable the Weekend Schedule in advance and then set the Weekend Start/End time. Press ESC to back to previous page.

## 3.6.3 Preset Record Configuration

The <Preset Config> is used to select the preset recording quality and frame rate. In normal circumstances, we strongly suggest you set the item to <Standard>, the default. Below table shows the PPS and picture size under <Standard> in Half-D1 mode. Please refer to OSD Menu Setup Guide, Section [Preset Record Configuration](#) for more detailed information.

| Half-D1 mode (NTSC: 720x240@60PPS; PAL: 720x288@50PPS) |             |                       |            |
|--|-------------|-----------------------|------------|
| Normal PPS   | Normal Size | Event PPS             | Event Size |
| 3.75 NTSC<br>(3.125 PAL)                               | 11 KB       | 15 NTSC<br>(12.5 PAL) | 17 KB      |



### 3.6.4 Per Camera Configuration

This function is used to set the Day / Night / Weekend PPS (Picture per Second) and Quality for each channel. The Preset Configuration must be set to <OFF> for accessing these schedules. The menu is displayed as below (Record Mode: 720x240@120PPS in NTSC / 720x288@100PPS in PAL).

| Per Camera Config |      |       |         |
|-------------------|------|-------|---------|
| Camera Select     | CH1  |       |         |
|                   | Day  | Night | Weekend |
| Normal PPS        | 7.5  | 7.5   | 7.5     |
| Normal Size       | Mid  | Mid   | Mid     |
| Event Max PPS     | 30   | 30    | 30      |
| Event Size        | Best | Best  | Best    |
| Event Active      | Both | Both  | Both    |

- Firstly, select a Camera for setting its record configuration. The image and recording settings from the selected camera will be displayed on the screen.
- Move the cursor using Direction keys and press ENTER to select an item.
- Change the value using UP / DOWN keys.
- Press ENTER to confirm the settings or ESC to abort.
- Press ESC to return to Record Setup menu.

Please note that the total normal pps for all channels cannot exceed 60 NTSC (720x240@60PPS) / 50 PAL (720x288@50PPS). To increase one channel's pps, you may have to reduce other's first. Event pps is not restricted to this rule, since a smart event scheduler will handle the total pps with a correct weighting.

### 3.6.5 To Record Event Video Only

If you want your DVR unit to start recording only under the alarm is triggered, follow the steps:

- Enter the OSD setup menu with correct password.
- In the OSD setup menu, select <Record Setup> menu. Move the cursor to the item <Preset Config>, and select <Event only>.

Refer to OSD Menu Setup Guide, Section Preset Record Configuration for more detailed information.

## 4. Basic Operation

The **AVE DR16X / AVE DR8X** series allows user to access some general operations through the front panel easily. The following sections introduce the general operations of the unit.

### 4.1 Viewing Live / Playback Video

The general functions in live and playback mode are described in the following sections.

#### 4.1.1 Viewing Modes

The **AVE DR16X / AVE DR8X** series supplies user versatile ways of viewing both live and recorded video. Following presents these view formats.

##### Viewing in Full Screen

Press any CHANNEL key directly to view the corresponding camera image in full view format.

##### Viewing in Multi-window

Various multi-window view formats are offered for selecting. To switch between available viewing formats, press MODE repeatedly.

The available view formats are illustrated as the following figure.

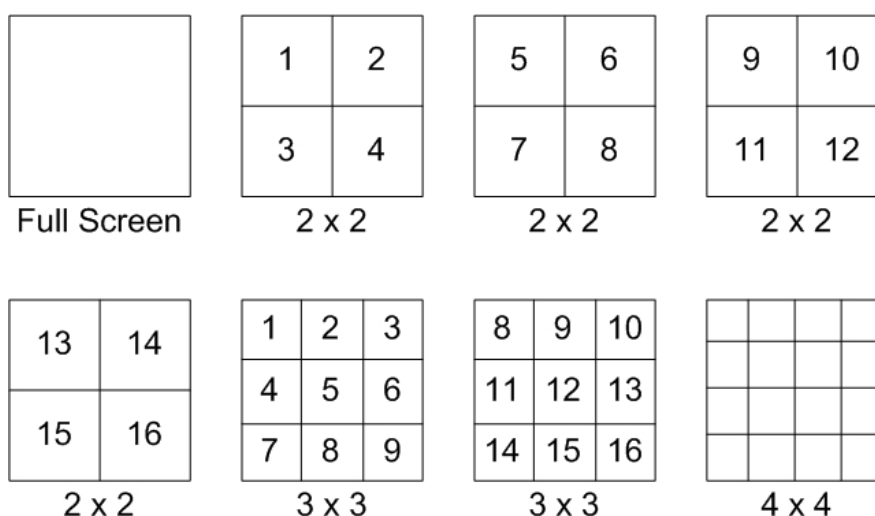

## 4.1.2 Digital Zoom

Users are able to view a 2x full screen in live mode. To view the 2x full screen, follow the steps.

- Press a CHANNEL key to view the corresponding camera in full screen.
- Press ZOOM to enter a 2x full screen zoom mode of the selected camera.
- If you need to view specific area of the 2x zoomed screen, use Direction keys to pan / tilt the zoomed area around the original image.
- Either press ZOOM again or ESC to leave the zoom mode.

## 4.1.3 Viewing Live Cameras

Users are allowed to view live camera in versatile view modes, including full-screen, 2x2 and 4x4. The general operation under live mode is described as follows.

### To Freeze Live Image

Press REEZE while viewing live image, the image pauses but the date / time information does not, and the system clock continues running.

Press FREEZE to pause the live image; press FREEZE again to resume the live camera view.

## 4.1.4 Viewing Recorded Video

To view recorded video, user can press PLAY/STOP key directly. When press the PLAY/STOP key, the unit starts to continue playing back the recorded video from the suspended point of record. If it is the first time to use the PLAY/STOP key, the unit will playback from the very beginning of the record. Alternatively, user can select records from the Search menu to play specific video. Refer to OSD Menu Setup Guide, Section [Searching Recorded Video](#) for more information.

The Forward or Reverse speed indicator will be shown on the bottom-left of the screen, when in the playback mode.

The general operations in playback mode are described as follows.

## Key Usage in Playback

The key usage is slightly changed in playback mode. Following is the key usage found in playback mode.

### **LEFT** (Reverse Playback)

The key is used to reverse the recorded video while the unit is playing back. Press the key repeatedly to increase the speed of reverse playback by 1x, 2x, 4x, 8x, 16x, or 32x.

### **RIGHT** (Forward Playback)

The key is used to play the recorded video fast forward. Press the key repeatedly to increase the speed of forward playback by 1x, 2x, 4x, 8x, 16x, or 32x.

### **FREEZE**

Press FREEZE to pause the playback video. When the recorded video is paused, press LEFT / RIGHT to resume playback video single step reverse / forward, respectively. Press FREEZE again to continue playing video.

### **PLAY/STOP**

Press to start playing back video, or to exit current mode or stop playing back video and back to live mode.

## Pause Playback and Single Step Forward

To pause and resume recorded video, follow these steps.

- Press one of the CHANNEL keys to display the corresponding camera in full screen.
- Press PAUSE to pause the current playback image.
- Press RIGHT / LEFT Direction keys to move the video single step reverse / forward. Press and hold RIGHT / LEFT keys to reverse / forward the video single step continuously.
- Press PAUSE again to resume the playback operation.

## Viewing Live Image in Playback Mode

Press the MODE key repeatedly in playback mode, a 16-window viewing mode contains both live and playback image appears. This view mode is illustrated as the following figure.

|   |   |   |   |
|---|---|---|---|
| 1 | 2 | 3 | 4 |
| 5 | 6 | 7 | 8 |
| 1 | 2 | 3 | 4 |
| 5 | 6 | 7 | 8 |

Live Image

Playback

The eight windows on the top side of the screen playback the Live video from channel 1 to channel 8 respectively, and the other windows allow user to view Playback image from channel 1 to channel 8.

### 4.1.5 Dual Main Output (For Unit with Turbo Module)

For users who use units with Turbo Module, they can use the Call Monitor as the second Main Monitor, and access lots of functions, such as setup OSD menu, and viewing in different mode, through the second Main Monitor. To perform this function, you have to reset a jumper positioned on the Turbo Module inside the unit.

To use this function, the VGA and BNC connectors, positioned on the rear panel, have to be connected with monitors, respectively. The VGA monitor is treated as the Main Monitor, and BNC monitor the second Main Monitor.

Press CALL key for 3 seconds, the BNC Monitor will be given the same function as the VGA Monitor, except Playback and Search function. You can use the BNC Monitor to take over the **AVE DR16X / AVE DR8X** unit at the same time, as if the two monitors are connected to two individual **AVE DR16X / AVE DR8X** units.

When using this function, a small figure (  ) appears in the mid-button side of the two monitors—the yellow one represents the monitor is now accessed.



**NOTE:** When the VGA monitor is now under Dome Control Mode' or the OSD setup mode, or hasn't exit the OSD menu, the BNC monitor cannot access the OSD setup menu.

## 4.2 Sequence Setup

This section introduce you how to view in sequence mode with both Main Monitor and Call Monitor, if connected. Sequence function can avoid manually backtracking and give more flexibility while surveillance.

### 4.2.1 Sequence with Main Monitor

Automatic sequence function can be used in any view mode. Select certain view format and press SEQ to toggle the automatic sequential sequence, press ESC to stop sequencing. The figure below displays the 4-camera and 9-camera sequencing view modes.

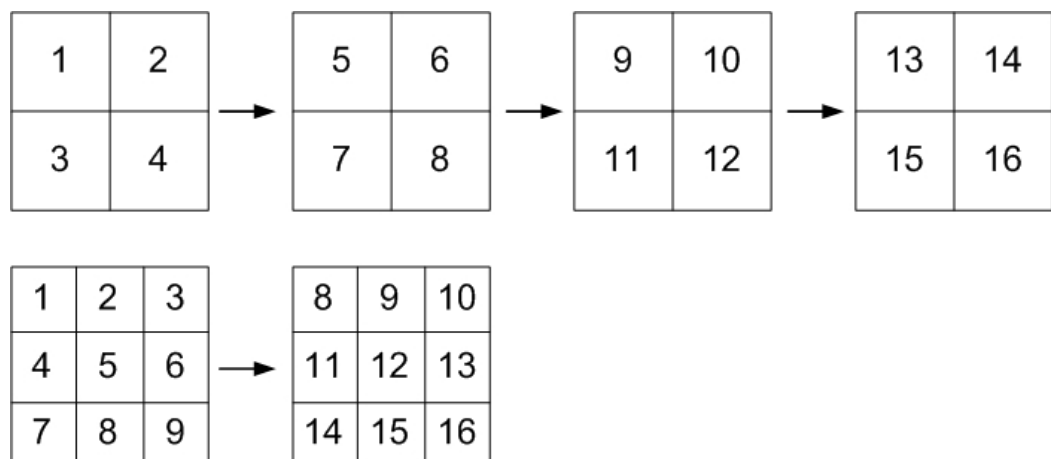

### 4.2.2 Sequence with Call Monitor

Users are allowed to use the **AVE DR16X / AVE DR8X** series unit front panel to control a call monitor display without having to access the Main menu. Two viewing modes can be displayed on call monitor: Sequence display and Single camera display. To program the call monitor sequence, see OSD Menu Setup Guide, Section [Sequence Setup](#).

Follow the steps to control the call monitor.

- Press the CALL key on the front panel to enter call monitor control mode, the message “Call Mode” will be shown on the bottom-left of the screen.

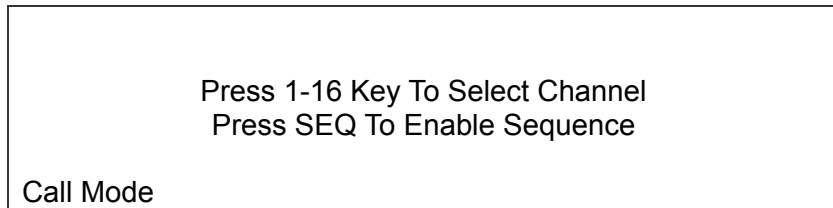

- Press CHANNEL key to display the associated camera on call monitor.
- Alternatively, press SEQ repeatedly to display the sequence of cameras previously programmed in Call Monitor Schedule menu.
- Press ESC to return the front panel to Main monitor control mode.

### 4.3 Searching Recorded Video

The **AVE DR16X / AVE DR8X** series is capable of searching and playing back recorded video by date and time or events. Entering the specific date and time of the wanted video, the unit will then search for the matched video and play it on the monitor. Alternatively, user can search event video by selecting channel as well.

In live or playback mode, press SEARCH to enter the Search menu, which is shown as follows.

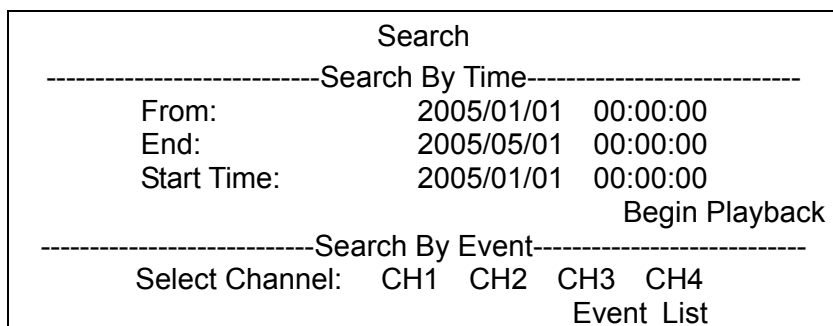

### 4.3.1 Searching by Time

Follow the steps to search video by date and time.

- Press SEARCH key to enter the Search menu; the From Time and End Time of the available video is listed on top of the screen. The value is unchangeable.
- Use Direction keys to move the cursor for setting the Start Time; adjusting the date and time values by UP / DOWN keys.
- Press ENTER to confirm the settings or ESC to abort.
- Move the cursor to <Begin Playback> and press ENTER to start playing back the selected video.
- Either press PLAY/STOP again or ESC to return to live video.



**NOTE:** If there is no available recorded video that matches your specified time and date, the unit starts playback from the next available video.



**NOTE:** The date/time information will be shown on the screen with a DST icon if the Daylight Saving Time function is enabled. “S” indicates summer time and “W” indicates wintertime.

### 4.3.2 Searching by Event

“Event List” allows you to search wanted video by event. The Event List is displayed as below figure:

| Event List |          |     |        |
|------------|----------|-----|--------|
| First Page |          |     |        |
| Date       | Time     | Ch. | Type   |
| 2005/03/17 | 11:26:50 | 2   | Motion |
| 2005/03/17 | 09:53:03 | 5   | Alarm  |
| 2005/03/16 | 16:14:42 | 3   | Alarm  |
| 2005/03/15 | 03:45:31 | 1   | Motion |
| 2005/03/12 | 22:27:56 | 1   | Alarm  |
| 2005/03/12 | 10:09:29 | 7   | Motion |
| 2005/03/11 | 12:18:20 | 6   | Motion |
| 2005/03/10 | 05:16:00 | 4   | Alarm  |
| 2005/03/08 | 17:11:37 | 2   | Motion |
| 2005/03/08 | 16:29:10 | 8   | Motion |
| 2005/03/08 | 03:22:17 | 2   | Alarm  |

The list displays events by date, time, triggered camera and alarm type. As some events are deleted, others are displayed. The latest recorded event video will be listed on the top.



Follow these steps to search event video through Event List:

- Press SEARCH to enter the Search menu.
- To search event video that has been recorded on a specific camera, use LEFT / RIGHT to move the cursor and press ENTER to select or de-select a channel.
- Move the cursor to <Event List> and press ENTER to list the event video of the selected channels. The Event List displays.
- To exit the event list, press ESC.

Follow the steps to playback video from Event List.

- Press and hold UP / DOWN to scroll through the Event List.
- Press ENTER to play back the selected event record.
- Press PLAY/STOP to return to live mode.

## **4.4 Video Export**

The following sections will guide you how to export video through the OSD Setup menu and through the hot keys positioned on the front panel, respectively.

### **4.4.1 Export from OSD Setup Menu**

The Video Export menu enables the administrator to export recorded video with digital signature to a USB ThumbDrive<sup>®</sup>, a CD-RW or to DVD+RW drive. Administrator's password is required to export video.

The exported video will be named by the exporting date and time, and classified by event type. Each recorded video will be exported into four files if exported with digital signature, including \*.gpg, \*.avi (\*.drv), \*.sig and readme.txt.

Make sure an external storage device is available and connected to the appropriate port for video export.

From the Main menu, select <Video Export> and press ENTER. The menu is displayed.

| Video Export         |                       |     |         |
|----------------------|-----------------------|-----|---------|
| 1. Select Device     |                       |     |         |
| 2. Select Ch:        | CH1                   | CH2 | CH3 CH4 |
| 3. From              | 2005/03/19 AM07:50:05 |     |         |
| 4. To                | 2005/03/28 PM03:09:18 |     |         |
| 5. Select Events     |                       |     |         |
| 6. Data Type         |                       |     | Normal  |
| 7. Export Format     |                       |     | DRV     |
| 8. Digital Signature |                       |     | NO      |
| 9. Erase Disc        |                       |     | NO      |
| 10. Begin Export     |                       |     | NO      |

#### 4.4.1.1 Select the External Device

The available external devices for exporting video will be listed by name and free size in Select Device menu. The Select Device menu displays as follows.

| Select Device  |           |     |  |
|----------------|-----------|-----|--|
| Device Name    | Available | Sel |  |
| xxx-xxx-x-x-xx | 256 MB    | NO  |  |
| xx-xxx-xx-xxxx | 1.5 GB    | NO  |  |

The **AVE DR16X / AVE DR8X** series only supports EXT3 file system. If you connect an external HDD to the unit, ensure the format of HDD is EXT3.

##### **Device Name**

The item shows the name of the available device.

##### **Available**

The item shows the free space of the available device.

##### **Select**

Set the item to <YES> to start the export, or <NO> to cancel.

## 4.4.1.2 Select Video for Exporting

After selecting video clips, set the item <Begin Export> to <YES> and press ENTER to start exporting. Following are the items for selecting video.

### **Select Channel**

Select the channel that the administrator wants to export. Move the cursor to the wanted channel using LEFT / RIGHT keys, select or de-select a channel by pressing ENTER.

### **From / To Time**

The items are used to set the time which data export begins and ends. Move the cursor using Direction keys, and press ENTER to select the date / time items; adjust the selected date and time value by UP / DOWN keys.



**NOTE:** The exported data between the Start Time and End Time includes both normal and event video.

### **Select Events**

Select the item to display the event list for exporting event video. Move the cursor scroll the event list and press ENTER to select the event you want to export.

### **Data Type**

The item is used to select exporting video type. The options are <Normal> (export normal video only), <Event> (export event video only) and <Both> (export both normal and event video).



**NOTE:** If you want to export event video only, then please set the “From” and “To” items at the same date and time. Otherwise, not only the event video but also the normal video included between the “From” date/ time and “To” date/time will be exported.

### **Export Format**

The item is for selecting exporting video format. The options are <DRV> and <AVI>.

The \*.drv file can only be played back with **DVRRemote** and **DVRPlayer** and multiple camera video can be played from one file. The \*.avi file can be played back with media players. Note that if multiple channels are exported, each channel is exported to a separate file.

### **4.4.1.3 Digital Signature**

User can export video clip with or without a digital signature. Set the item to <YES> to export with the signature file, or <NO> exports without the signature file.

Each recorded video with digital signature will be exported into four files, including \*.gpg, \*.avi, \*.sig and readme.txt. The \*.gpg file name is as the last eight MAC (Media Access Control) address of the unit.

Make sure that you have an external storage device, such as a USB Hard Drive or USB ThumbDrive<sup>®</sup>, available and connected to the appropriate port for export.

For more information on verifying digital signature, see [Appendix D: Verifying Digital Signature](#).

### **4.4.1.4 Erase Disc**

This function is used to remove data found on a CD-RW or DVD+RW disk prior to export new information to the drive. Select <YES> and press ENTER to start deleting data.

### **4.4.2 Quick Video Export through Front Panel**

The unit allows you to export wanted video to the built-in CD-RW or an external device, such as a USB ThumbDrive<sup>®</sup>, and save the video to \*.drv file.

If you want to export video to an external device, make sure the external storage has been connected to the DVR unit and the port has been set appropriately for video export.



**NOTE:** Once an external device has been connected to the DVR unit, the device has priority over the built-in CD-RW; which means that the wanted video will be exported to the external device instead of the built-in CD-RW.

According to the size of video, the export may take you about 10 minutes to 1 hour.

#### 4.4.2.1 ezBurn Introduction

Built with the ezBurn technology, ezBurn function provides users the easier way to export desired video with CD-RW built in or to an external device connected, such as an USB ThumbDrive®.

TWO keys (SEARCH and CALL) and THREE touches are all you need for completing the export. The whole exporting process will be done through the front panel, but no need to enter the OSD setup menu.

The ezburn export process is illustrated as below figure:

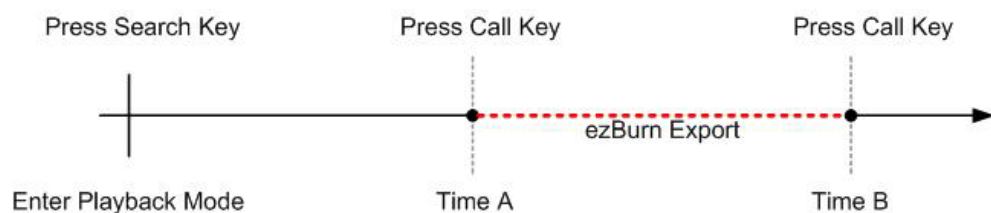

The whole process is described step by step in the following sections.

#### 4.4.2.2 To Export Normal Video

To Export normal video to external device, follow these step:

- Press SEARCH and play wanted normal video by entering date and time. Note if you are viewing in multiple channel mode, please make sure there is no window displaying in Live mode. Otherwise, the export won't work.
- After entering playback mode, plays the video and press CALL on the point that you want to start the export. The playback continues.

- Press CALL again on the point that you want to end the export. Now, the “ezBurn” window displays as below figure. The information shown on the window is for read only.

- 

```

ezBurn confirmation
Selected Device: Built-in-CD-RW
All data on the disc will be erased.
Exported Required Size = 11 MB
Real Export Range:
From: 2005/11/07 AM10:41:13
To: 2005/11/07 AM10:41:21
Enter: YES ESC: NO

```

- If there is no any exportable external device connected to the DVR unit, then a warning message will be shown on the screen, as below figure:

```

No exportable device detected.
Please install the target device/media
to the DVR.
Enter: Retry ESC: Exit

```

- Press ENTER to start the export; or, press ESC to abort.

### 4.4.2.3 To Export Event Video

To export event video, follow these steps:

- Press SEARCH and play wanted event video. To play event video, refer to OSD Menu Setup Guide, Section [Searching Recorded Video](#).
- After entering the playback mode, press CALL. The “ezBurn” window displays as below figure. The information shown on it is for read only.

```

ezBurn confirmation
Selected Device: Built-in-CD-RW
All data on the disc will be erased.
Exported Required Size = 11 MB
Export Event Info:
Data          Time          Ch          Type
2005/11/07   AM10:42:35   13         Motion
Enter: YES   ESC: NO

```

- If there is no any exportable external device connected to the DVR unit, a warning message will be shown on the screen
- Press ENTER to start the export the whole event video to the connected device; or, press ESC to abort.

## 4.5 Deleting Recorded Video

User can delete the recorded video in Purge Data menu. The administrator password is required to access the function. Select <Record Setup> from Main menu, and then in Record Setup menu, move the cursor to <Purge Data> and press ENTER; the Purge Data menu is displayed.

| Purge Data              |            |    |
|-------------------------|------------|----|
| 1. Purge All Data       |            | NO |
| 2. Purge All Event Data |            | NO |
| 3. Purge Event Before   | 2000/01/01 |    |
| 4. Start to Purge       |            | NO |

The first three items are used to select the data that you want be purged. The items are described as follows. After select the data you want to purge, set the forth item <Start to Purge> to <YES> and press ENTER to start the deleting process.

### **Purge All Data**

Select the item to delete all normal recorded video from database.

### **Purge All Event Data**

Select the item to delete all event video from database.

### **Purge Event Before**

The item is used to delete event video that recorded before a specific date.

## 4.6 Dome Control

**AVE DR16X / AVE DR8X** series unit allows user to control a dome camera by the front panel.

In Live mode, user can press CHANNEL key to display the desired dome camera in full view. To enter Dome Control mode, press the DOME key and press channel key 2 to display the hint screen; to exit the Dome Control mode and back to live mode, press ESC or DOME. To configure the dome controls settings, see the following sections.

## 4.6.1 Dome Connection

Follow the steps to install dome camera.

- See OSD Menu Setup Guide, Section [Rear Panel Connections](#) for RS-485 port pin definition.
- Refer to the following figure. Connect the R+, R- terminals on the dome camera to the D+, D- terminals on the RS-485 port by RS-485 cable respectively.

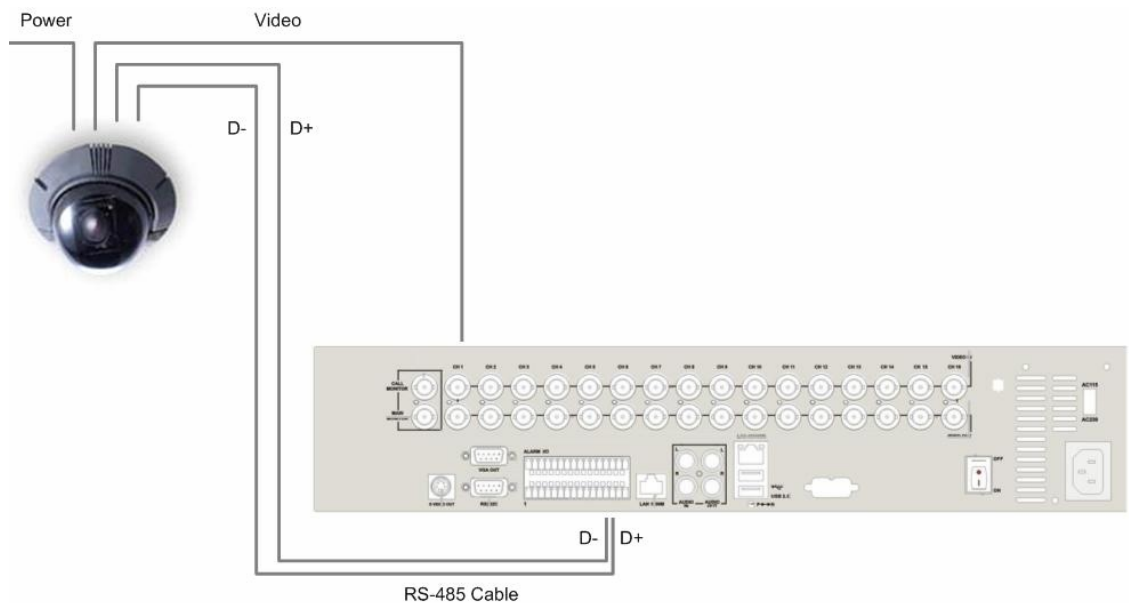

## 4.6.2 Dome Protocol Setup

The Dome Protocol item lists the available dome protocols for communicating with dome cameras connected to the **AVE DR16X / AVE DR8X** series. From the Main menu, select <Camera Setup> and press ENTER. The following menu is displayed.

| Camera Setup          |      |
|-----------------------|------|
| 1. Camera Select      | CH1  |
| 2. Dome Protocol      | None |
| 3. Dome ID            | 0    |
| 4. Camera Title       |      |
| 5. Covert             | NO   |
| 6. Termination        | NO   |
| 7. Brightness         | 0    |
| 8. Contrast           | 0    |
| 9. Saturation         | 0    |
| 10. Hue               | 0    |
| 11. Audio Association | Both |



To configure dome protocol, select a camera first and set the communications protocol associated with dome camera using the Direction keys and ENTER. The available protocol includes <DynaColor>, <Pelco D>, <Pelco P>, <AD422>, <Fastrax 2> and <None> (default).



**NOTE:** The settings become effective after saving the changes and exiting from the menu.

### 4.6.3 RS485 Setup

**AVE DR16X / AVE DR8X** series controls the domes via RS-485 communication protocol. The RS-485 parameters of **AVE DR16X / AVE DR8X** series must be set to the same as the parameters set in dome camera .

Users are allowed to change the RS-485 settings of the **AVE DR16X / AVE DR8X** series. Select <System Setup> in Main menu, then select <RS485 Setup> from the System Setup menu and press ENTER. The following menu is displayed.

| RS485 Setup |      |
|-------------|------|
| 1 Unit ID   | 224  |
| 2 Baud Rate | 9600 |
| 3 Bits      | 8    |
| 4 Stop      | 1    |
| 5 Parity    | None |

The ID number must match the ID address set by the dome. The Unit ID is in the range of 1 to 255. The default ID is 224. Note that no two devices on the same bus should be given the same ID address, or a conflict may occur.

The default **AVE DR16X / AVE DR8X** series RS-485 settings are 9600 Baud, 8 Data Bits, 1 Stop Bit and No Parity.



**NOTE:** The settings become effective after saving the changes and exiting from the menu.

## 4.6.4 Dome Controlling Key

The function keys used in Dome Control are described as follows.



### **Set / Go Preset**

This key is used to enter the Dome Preset menu to set up certain position as a preset and go to the predetermined preset positions for viewing.



### **Toggle Hint Screen**

This function is used to avoid viewing the dome parameter information while controlling dome camera. Press this key to hide the screen. Press it again to redisplay the screen.



### **Iris Open**

Use to open the Iris on the dome camera.



### **Focus Near**

Use to focus the dome camera near.



### **Zoom In**

Use to zoom the dome camera in. This function is for user to choose the viewing area, more or less of it.



### **ESC**

Use to leave dome control mode and return to live and full screen viewing mode.



### **Auto / Enter**

- In OSD Menu mode, the key is used to make selection.
- In dome control mode, this key is used to activate automatic focus and iris function.



### **Iris Close**

Use to close the Iris on the dome camera.



### **Focus Far**

Use to focus the selected dome camera far.



### **Zoom Out**

Use to zoom the dome camera out. This function is for user to choose the viewing area, more or less of it.



### **Pan / Tilt**

Use to pan and tilt dome camera.

## **4.6.5 Setting Preset Points**

The **AVE DR16X / AVE DR8X** series unit allows user to set preset positions; the amount of preset points depends on the dome manufacturer.

Follow the steps to set preset points.

- Press a Channel key to view the corresponding camera in full screen.
- Then press DOME to enter dome control mode. And a Hint Screen, shown as blow figure, displays on the screen.
- Press 2 again to hide the dome control Hint Screen; press 2 one more time to toggle the Hint Screen.
- Use Direction keys to position the dome camera to desired position.

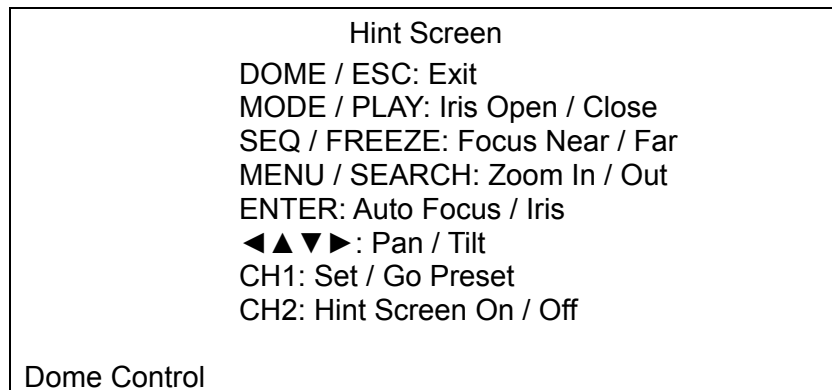

- Press 1 to access the Set/Go Preset function. The Dome Preset menu is displayed.

| Dome Preset |            |           |  |
|-------------|------------|-----------|--|
| Index       | Set Preset | Go Preset |  |
| 1           | NO         | NO        |  |
| 2           | NO         | NO        |  |
| 3           | NO         | NO        |  |
| 4           | NO         | NO        |  |
| 5           | NO         | NO        |  |
| 6           | NO         | NO        |  |
| 7           | NO         | NO        |  |

- Use UP / DOWN keys to select the desired preset number from the menu.
- Set the <Set Preset> of the selected preset number to <YES>, and press ENTER to save the position. Now the preset is set and ready to call.

#### 4.6.6 Calling Preset Points

Follow the steps to call preset points.

- Press a Channel key to view the corresponding camera in full screen.
- Then press DOME to enter dome control mode. And a Hint Screen, shown as blow figure, displays on the screen.
- Press 2 again to hide the dome control Hint Screen; press 2 one more time to toggle the Hint Screen.
- Press 1 to access the Set/Go Preset function.

| Dome Preset |            |           |  |
|-------------|------------|-----------|--|
| Index       | Set Preset | Go Preset |  |
| 1           | NO         | NO        |  |
| 2           | NO         | NO        |  |
| 3           | NO         | NO        |  |
| 4           | NO         | NO        |  |
| 5           | NO         | NO        |  |
| 6           | NO         | NO        |  |
| 7           | NO         | NO        |  |

- Use UP / DOWN keys to select the desired preset number from the menu.
- Set the <Go Preset> of the selected preset number to <YES>, and press ENTER to call the preset point.
- Now the selected dome camera rotates to the preset position automatically.

## Appendix A: Technical Specifications

All specifications are subject to change without notice.

| MODEL NAME          |                           | AVE DR16X / AVE DR8X   |  |  |  |
|---------------------|---------------------------|------------------------|--|--|--|
| Video               | Operation System          |                        | Embedded ( Linux )   |  |  |
|                     | Video Standard            |                        | NTSC/PAL switch selectable   |  |  |
|                     | Video Operation           |                        | Triplex+( Live, Record, Playback , Remote, and Internet access )           |  |  |
|                     | Resolution – Live Video   |                        | NTSC: 720 x 480 pixels PAL: 720 x 576 pixels                               |  |  |
|                     | Input                     |                        | BNC x 16,1.0Vp-p/75 ohm  |  |  |
|                     | Outputs                   | Main Monitor           | BNC x 1, S-Video x 1, 1.0Vp-p/75 ohm                                       |  |  |
|                     |                           | Call monitor           | BNC x 1, 1.0Vp-p/75 ohm  |  |  |
|                     |                           | Loop                   | BNC x 16,1.0Vp-p/75 ohm  |  |  |
|                     | VGA Output                |                        | 800 x 600, 1024 x 768, 1280 x 1024 pixels @ 60Hz                           |  |  |
|                     | Picture Refresh Rate      |                        | NTSC: 480 PPS(16CH)<br>PAL: 400 PPS(16CH)                                  |  |  |
| Digital Zoom        |                           | 2 x 2                  |  |  |  |
| Camera Installation |                           | Plug & Play            |  |  |  |
| Audio               | Input                     |                        | RCA x 2, Line-In   |  |  |
|                     | Output                    |                        | RCA x 2, Line-Out  |  |  |
|                     | Recording Mode            |                        | Always Real Time Record, Synchronized w/ Video                             |  |  |
|                     | Compression Method        |                        | ADPCM, G.726   |  |  |
|                     | File Size                 |                        | 8KB/Sec  |  |  |
|                     | Operation                 |                        | Remote + VCR mode  |  |  |
|                     | Playback                  |                        | Only for Video Original Speed  |  |  |
| Recording           | Compression Method        |                        | MPEG-4 Advanced Simple Profile   |  |  |
|                     | Recording Mode            |                        | Schedule, Alarm, Motion Detection  |  |  |
|                     | Pre-Alarm                 |                        | 0~30 sec   |  |  |
|                     | Resolution & Rate         | NTSC                   | 720x480: 120 pps   |  |  |
|                     |                           |                        | 720x240: 240 pps   |  |  |
|                     |                           |                        | 360x240: 480 pps   |  |  |
|                     |                           | PAL                    | 720x576: 100 pps   |  |  |
|                     |                           |                        | 720x288: 200 pps   |  |  |
|                     |                           |                        | 360x288: 400 pps   |  |  |
|                     | Recording Quality         |                        | 8 levels presets, adjustable   |  |  |
| Image Size          |                           | 2K to 20K Byte/picture |  |  |  |
| Storage Mode        |                           | Linear/Circular        |  |  |  |
| Playback            | Playback                  |                        | Play, Stop, Pause, Rewind, Forward, Search                                 |  |  |
|                     | Playback Speed Adjustment |                        | Yes 1X, 2X...32X   |  |  |
|                     | Retrieve                  |                        | Date/Time, Event   |  |  |
|                     | Data Life Time            |                        | Yes(Programmable)  |  |  |
| Storage             | Build-in Storage          |                        | X2 ATA 133 / UDMA 133 IDE, HDD/CD-RW/DVD+RW                                |  |  |
|                     | Built-in HDD              |                        | NAS  |  |  |
|                     | Export                    |                        | X3 USB2.0 ports, support ThumbDrive®, CD-RW, or DVD+RW                     |  |  |
| Alarm               | Alarm Input               |                        | X4, Terminal Block   X8, Terminal Block   X16, Terminal Block              |  |  |
|                     | Alarm Detection           |                        | N.C./N.O., Programmable  |  |  |
|                     | Auditory Alert            |                        | Built-in Buzzer  |  |  |
|                     | Motion Detection          |                        | 21 X 13(NTSC), 21 X 16(PAL) Grid Array, Sensitivity, Trig Level Adjustable |  |  |
|                     | Video Loss Detection      |                        | Programmable   |  |  |
|                     | Alarm Relay Output        |                        | X3, Terminal Block, 1.0A/24V (Programmable)                                |  |  |
| Communication       | Network Connectivity      |                        | Ethernet RJ-45 connector, 10/100Mbps, supports DHCP/PPPoE/DDNS             |  |  |
|                     | Remote Control Software   |                        | DVRRemote  |  |  |
|                     | Access Control            |                        | 2 Level Password   |  |  |
|                     | Remote Operation          |                        | Monitoring, Playback, Recording, System Setup, Dome Camera Control         |  |  |

---

|  |                       |   |
|--|-----------------------|---|
|  | RS232C                | D-sub 9 pin female                            |
|  | RS485                 | Terminal Block                                |
|  | Dome Control Protocol | DynaColor, Pelco P, Pelco D, AD422, Fastrax 2 |