

Panasonic

Cordless Drill & Driver

Operating Instructions

Model No: EY6450

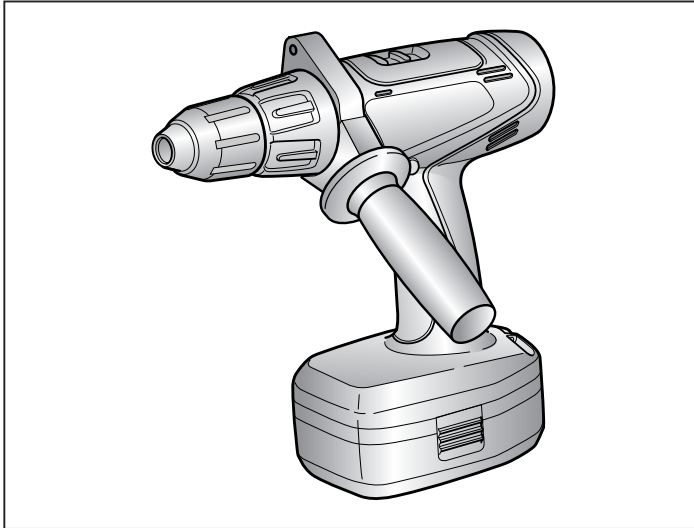

IMPORTANT

This manual contains safety information. Read manual completely before first using this product and save this manual for future use.

I. GENERAL SAFETY RULES - FOR ALL BATTERY OPERATED TOOLS

WARNING!

READ AND UNDERSTAND ALL INSTRUCTIONS.

- Failure to follow all instructions listed below, may result in electric shock, fire and/or serious personal injury.

SAVE THESE INSTRUCTIONS

Work Area

- 1) **Keep your work area clean and well lit.**
Cluttered benches and dark areas invite accidents.
- 2) **Do not operate power tools in explosive atmospheres, such as in the presence of flammable liquids, gases, or dust.**
Power tools create sparks which may ignite the dust or fumes.
- 3) **Keep bystanders, children, and visitors away while operating a power tool.**
Distractions can cause you to lose control. Make sure that no one is beneath, or on the other side of the area when you are working.

Electrical Safety

- 4) **A battery operated tool with integral batteries or a separate battery pack must be recharged only with the specified charger for the battery.**
A charger that may be suitable for one type of battery may create a risk of fire when used with another battery.
- 5) **Use battery operated tool only with specifically designated battery pack.**
Use of any other batteries may create a risk of fire.

Personal Safety

- 6) **Stay alert, watch what you are doing, and use common sense when operating a power tool. Do not use tool while tired or under the influence of drugs, alcohol, or medication.**
A moment of inattention while operating power tools may result in serious personal injury.
- 7) **Dress properly. Do not wear loose clothing or jewelry. Contain long hair.**
Keep your hair, clothing, and gloves away from moving parts.
Loose clothes, jewelry, or long hair can be caught in moving parts.
- 8) **Avoid accidental starting. Be sure switch is in the locked or off position before inserting battery pack.**
Carrying tools with your finger on the switch or inserting the battery pack into a tool with the switch on invites accidents.
- 9) **Remove adjusting keys or wrenches before turning the tool on.**
A wrench or a key that is left attached to a rotating part of the tool may result in personal injury.
- 10) **Do not overreach. Keep proper footing and balance at all times.**
Proper footing and balance enable better control of the tool in unexpected situations.
- 11) **Use safety equipment. Always wear eye protection.**
Dust mask, non-skid safety shoes, hard hat, or hearing protection must be used for appropriate conditions.
- 12) **Use clamps or other practical way to secure and support the work-piece to a stable platform.**
Holding the work by hand or against your body is unstable and may lead to loss of control.
- 13) **Do not force tool. Use the correct tool for your application.**
The correct tool will do the job better and safer at the rate for which it is designed.

14) **Do not use tool if switch does not turn it on or off.**

A tool that cannot be controlled with the switch is dangerous and must be repaired.

15) **Disconnect battery pack from tool or place the switch in the locked or off position before making any adjustments, changing accessories, or storing the tool.**

Such preventive safety measures reduce the risk of starting the tool accidentally.

16) **Store idle tools out of reach of children and other untrained persons.**

Tools are dangerous in the hands of untrained users.

17) **When battery pack is not in use, keep it away from other metal objects like: paper clips, coins, keys, nails, screws, or other small metal objects that can make a connection from one terminal to another.**

Shorting the battery terminals together may cause sparks, burns or a fire.

18) **Maintain tools with care. Keep cutting tools sharp and clean.**

Properly maintained tools with sharp cutting edge are less likely to bind and are easier to control.

19) **Check for misalignment or binding of moving parts, breakage of parts, and any other condition that may affect the tool's operations. If damaged, have the tool serviced before using.**

Many accidents are caused by poorly maintained tools.

20) **Use only accessories that are recommended by the manufacturer for your model.**

Accessories that may be suitable for one tool may create a risk of injury when used on another tool.

Service

21) **Tool service must be performed only by qualified repair personnel.**

Service or maintenance performed by unqualified personnel may result in a risk of injury.

22) **When servicing a tool, use only identical replacement parts. Follow instructions in the Maintenance section of this manual.**

Use of unauthorized parts or failure to follow Maintenance Instructions may create a risk of shock or injury.

II. SPECIFIC SAFETY RULES

1) **Hold tool by insulated gripping surfaces when performing an operation where the cutting tool may contact hidden wiring.**

Contact with a "live" wire will also make exposed metal parts of the tool "live" and shock the operator.

2) **Wear ear protectors when using the tool for extended periods.**

Prolonged exposure to high intensity noise can cause hearing loss.

3) **Be aware that this tool is always in an operating condition, it does not have to be plugged into an electrical outlet.**

4) **Do not operate the Forward/Reverse lever when the Variable speed control trigger is on.**



The battery will discharge rapidly and damage to the unit may occur.

5) **If the bit becomes jammed, immediately turn the Variable speed control trigger off to prevent an overload which can damage the battery pack or motor. Use reverse motion to loosen jammed bits.**

6) **When storing or carrying the tool, set the Forward/Reverse lever to the center (switch lock) position.**

7) **Do not strain the tool by holding the speed control trigger halfway (speed control mode) so that the motor stops.**

- 8) During charging, the charger may become slightly warm. This is normal. Do not charge the battery for a long period.

Symbol	Meaning
V	Volts
---	Direct Current
n ₀	no load speed
.../min	revolutions or reciprocation per minutes
	Forward Rotation
	Reverse Rotation
	Rotation only

WARNING:

Some dust created by power sanding, sawing, grinding, drilling, and other construction activities contains chemicals known to the State of California to cause cancer, birth defects or other reproductive harm. Some examples of these chemicals are:

- Lead from lead-based paints
- Crystalline silica from bricks and cement and other masonry products
- Arsenic and chromium from chemically-treated lumber.

To reduce your exposure to these chemicals: work in a well ventilated area, and work with approved safety equipment, such as dust masks that are specially designed to filter out microscopic particles.

III.FOR BATTERY CHARGER & BATTERY PACK IMPORTANT SAFETY INSTRUCTIONS

1) SAVE THESE INSTRUCTIONS

- This manual contains important safety and operating instructions for battery charger EY0110.

- 2) Before using battery charger, read all instructions and cautionary markings on (1) battery charger, (2) battery pack.

3) CAUTION

- To reduce the risk of injury, charge only Battery Pack as shown below.

EY9065, EY9066, EY9168, EY9080, EY9086, EY9180, EY9182, EY9001, EY9006, EY9101, EY9106, EY9200, EY9201, EY9136, EY9230, EY9231, EY9251, EY9117, EY9210

Other types of batteries may burst causing personal injury and damage.

- 4) Do not expose charger to rain or snow.
- 5) To reduce risk of damaging the electric plug and cord, pull by plug rather than cord when disconnecting charger.
- 6) Make sure cord is located so that it will not be stepped on, tripped over, or otherwise subjected to damage or stress.
- 7) An extension cord should not be used unless absolutely necessary. Use of improper extension cord could result in a risk of fire and electric shock. If extension cord must be used, make sure that:
- a. pins on plug of extension cord are the same number, size and shape as those of plug on charger.
 - b. extension cord is properly wired and in good electrical condition.
 - c. wire size is large enough for ampere rating of charger as specified below.

RECOMMENDED MINIMUM AWG SIZE OF EXTENSION CORDS FOR BATTERY CHARGERS		
AC Input Rating.	Amperes	AWG Size of Cord
Equal to or greater than	But less than	Length of Cord, Feet 25 50 100 150
0	2	18 18 18 16

- 8) Do not operate charger with damaged cord or plug — replace them immediately.
- 9) Do not operate charger if it has received a sharp blow, been dropped, or otherwise damaged in any way; take it to a qualified serviceman.
- 10) Do not disassemble charger; take it to a qualified serviceman when service or repair is required. Incorrect reassembly may result in a risk of electric shock or fire.
- 11) To reduce the risk of electric shock, unplug charger from outlet before attempting any maintenance or cleaning.
- 12) The charger and battery pack are specifically designed to work together. Do not attempt to charge any other cordless tool or battery pack with this charger.
- 13) Do not attempt to charge the battery pack with any other charger.
- 14) Do not attempt to disassemble the battery pack housing.
- 15) Do not store the tool and battery pack in locations where the temperature may reach or exceed 50°C (122°F) (such a metal tool shed, or a car in the summer), which can lead to deterioration of the storage battery.
- 16) Do not charge battery pack when the temperature is BELOW 0°C (32°F) or ABOVE 40°C (104°F). This is very important in order to maintain optimal condition of the battery pack.
- 17) Do not incinerate the battery pack. It can explode in a fire.
- 18) Avoid dangerous environment. Do not use charger in damp or wet locations.
- 19) The charger is designed to operate on standard household electrical power only. Do not attempt to use it on any other voltage!

- 20) Do not abuse cord. Never carry charger by cord or yank it to disconnect from outlet. Keep cord away from heat, oil and sharp edges.
- 21) Charge the battery pack in a well ventilated place, do not cover the charger and battery pack with a cloth, etc., while charging.
- 22) Use of an attachment not recommended may result in a risk of fire, electric shock, or injury to persons.
- 23) Do not short the battery pack. A battery short can cause a large current flow, over heating and create the risk of fire or personal injury.
- 24) NOTE: If the supply cord of this appliance is damaged, it must only be replaced by a repair shop authorized by the manufacturer, because special purpose tools are required.
- 25) TO REDUCE THE RISK OF ELECTRIC SHOCK, THIS APPLIANCE HAS A POLARIZED PLUG (ONE BLADE IS WIDER THAN THE OTHER).
This plug will fit in a polarized outlet only one way. If the plug does not fit fully in the outlet, reverse the plug. If it still does not fit, contact a qualified electrician to install the proper outlet. Do not change the plug in any way.

IV.FUNCTIONAL DESCRIPTION

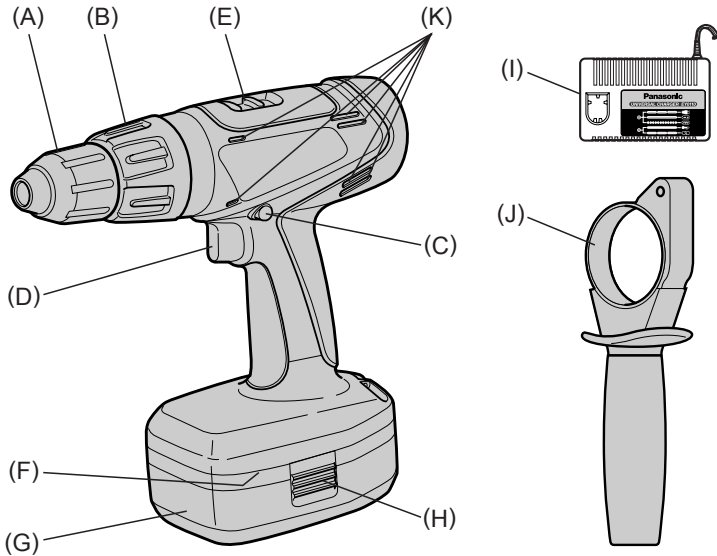

(A)	Keyless drill chuck (EY9799)	(G)	Battery pack(EY9251)
(B)	Clutch handle	(H)	Battery pack release button
(C)	Forward / Reverse lever	(I)	Battery charger (EY0110)
(D)	Variable speed control trigger	(J)	Support handle
(E)	Speed selector switch	(K)	Vent holes
(F)	Bit holder		

V. ASSEMBLY

Attaching or removing bit

NOTE:

When attaching or removing a bit, disconnect battery pack from tool or place the switch in the center position (switch lock).

This tool is equipped with a keyless drill chuck.

1. Attachment

Insert the bit and turn the lock collar clockwise (looking from the front) to tighten firmly until it stops clicking.

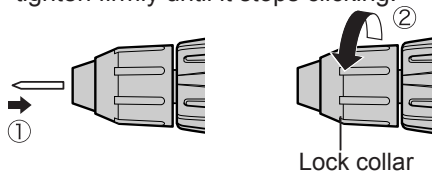

2. Removal

Turn the lock collar counterclockwise (looking from the front), then remove the bit.

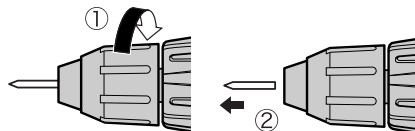

3. Storage

Keep the bit in bit holder when not in use.

Remove the battery pack to expose the bit storage compartment inside the handle housing.

Bits up to 50 mm (1-31/32 inch) long can be stored here.

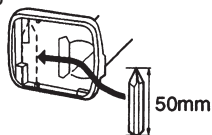

NOTE:

If excessive play occurs in the chuck, secure the drill in place and ① open the chuck jaws by turning the lock collar and ② tighten the screw (left-handed screw) with a screwdriver by turning it counterclockwise (viewed from the front).

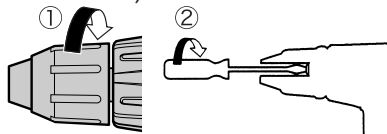

Attaching or removing battery pack

1. To connect the battery pack:
Insert the battery pack. It snaps into place to indicate proper connection.
2. To remove the battery pack:
Press the two buttons on the sides of the battery pack. Slide the battery pack out of the tool body.

Support handle

Place the support handle at your favorite position and tighten the handle securely.

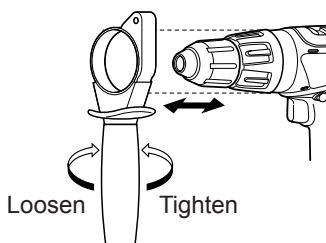

Remove the handle when placing the tool in the storage case.

VI. OPERATION

Switch Operation

1. The speed increases with the amount of depression of the trigger. When beginning work, depress the trigger slightly to start the rotation slowly.
2. A feedback electronic controller is used to give a strong torque even in low speed.
3. The brake operates when the trigger is released and the motor stops immediately.

NOTE:

When the brake operates, a braking sound may be heard. This is normal.

Forward / Reverse lever Operation

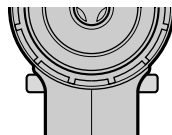

(Forward (U), Switch lock, Reverse (J))

CAUTION:

Do not operate Forward/Reverse lever until the chuck comes to a complete stop. Shifting during rotation of the chuck may damage the tool.

Forward Rotation Switch Operation

1. Push the lever for forward rotation.
2. Depress the trigger switch slightly to start the tool slowly.
3. The speed increases with the amount of depression of the trigger for efficient tightening of screws and drilling. The brake operates and the chuck stops immediately when the trigger is released.
4. After use, set the lever to its center position (switch lock).

Reverse Rotation Switch Operation

1. Push the lever for reverse rotation. Check the direction of rotation before use.
2. Depress the trigger switch slightly to start the tool slowly.
3. After use, set the lever to its center position (switch lock).

Clutch Torque Setting

Adjust the torque to one of the 15 possible settings or “ $\frac{1}{2}$ ” position to the job.

CAUTION:

Test the setting before actual operation.

Set the scale at this mark (\triangleleft).

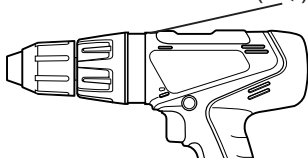

Speed Selection

Choose a low or high speed to suit the use.

The more the speed control trigger is pulled, the higher the speed becomes.

CAUTION:

- Check the speed selector switch before use.
- Use at low speed when strong force is needed during opera-

tion. (Using at high speed while a strong force is applied may cause a motor breakdown.)

- Do not operate the speed selector switch (LOW-HIGH) while pulling on the speed control trigger. This can cause the rechargeable battery to wear quickly or damage the internal mechanism of the motor.

*See appendix for “RECOMMENDED SPEED SELECTION”.

NOTE:

When the brake operates, a braking sound may be heard.

This sound indicates engagement of the bit lock.

CAUTION:

- To eliminate excessive temperature increase of the tool surface, do not operate the tool continuously using two or more battery packs. Tool needs cool off time before switching to another pack.
- Do not close up vent holes on body sides of the body during operation. Otherwise, the machine function is adversely affected to cause a failure.
- Do not strain the tool (motor). This may cause damage to the unit.
- Use the machine in such a way as to prevent the air from the body vent holes from blowing directly onto your skin. Otherwise, you may get burnt.
- When operating with a Ni-MH battery pack, make sure the place is well-ventilated.

Bit-locking function

1. With the trigger switch not engaged and a screwdriver bit locked in place, the tool can be used as a manual screwdriver (up to 22.6 Nm, 230 kgf-cm, 199 in-lbs).
There will be a little play in the chuck, but this is not a malfunction.
2. This feature is handy for tightening screws that require more torque than the maximum torque of the driver (position $\frac{1}{2}$ on the clutch), for confirming the tightness of a screw or to loosen an extremely tight screw.

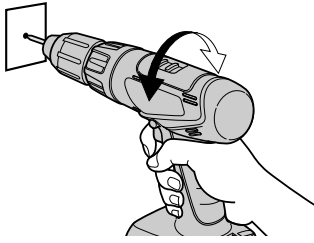

For Appropriate use of Battery pack

Ni-MH Battery pack (EY9251)

- Charge the Ni-MH battery fully before storage in order to ensure a longer service life.
- The ambient temperature range is between 0°C (32°F) and 40°C (104°F). If the battery pack is used when the battery temperature is below 0°C (32°F), the tool may fail to function properly. In that case, charge the battery until charging is completed for appropriate functioning of the battery.
- When battery pack is not in use, keep it away from other metal objects like: paper clips, coins, keys, nails, screws, or other small metal objects that can make a connection from one terminal to another. Shorting the battery terminals together may cause sparks, burns or a fire.
- When operating with a Ni-MH battery pack, make sure the place is well-ventilated.

Battery Pack Life

The rechargeable batteries have a limited life. If the operation time becomes extremely short after recharging, replace the battery pack with a new one.

NOTE:

Use under extremely hot or cold conditions will reduce operating capacity per charge.

Charging

NOTE:

When you charge the battery pack for the first time, or after prolonged storage, charge it for about 24 hours to bring the battery up to full capacity.

Battery charger (EY0110)

1. Plug the charger into the AC outlet.

NOTE:

Sparks may be produced when the plug is inserted into the AC power supply, but this is not a problem in terms of safety.

2. Insert the battery pack firmly into the charger.

Battery pack

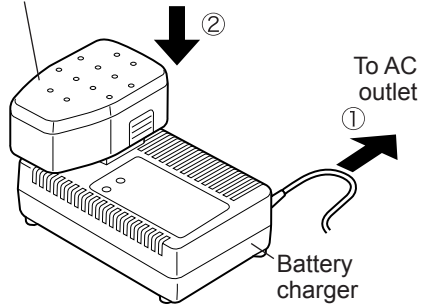

3. During charging, the charging lamp will be lit. When charging is completed, an internal electronic switch will automatically be triggered to prevent overcharging.
 - Charging will not start if the battery pack is warm (for example, immediately after heavy-duty operation). The orange standby lamp will be lit until the battery cools down. Charging will then begin automatically.
4. When charging is completed, the charging lamp will start flashing quickly in green color.
5. When in any of the conditions that battery pack is too cool, or the battery pack has not been used for a long time, the charging lamp is lit. In this case, charging takes longer to fully charge the battery pack, than the standard charging time.
 - If a fully charged battery pack is inserted into the charger again, the charging lamp light up. After several minutes, the charging lamp may flash quickly to indicate the charging is completed.
6. If the charging lamp does not light immediately after the charger is plugged in, or if after the standard charging time the lamp does not go off, consult an authorized dealer.

NOTE:

- When charging a cool battery pack (below 5°C (41°F)) in a warm place, leave the battery pack at the place and wait for more than one hour to warm up the battery to the level of the ambient temperature. Otherwise battery pack may not be fully charged.
- Cool down the charger when charging more than two battery

packs consecutively.

- Do not insert your fingers into contact hole, when holding charger or any other occasions.

CAUTION:

- Do not use power source from an engine generator.
- Do not cover vent holes on the charger and the battery pack.

VII. LAMP INDICATIONS

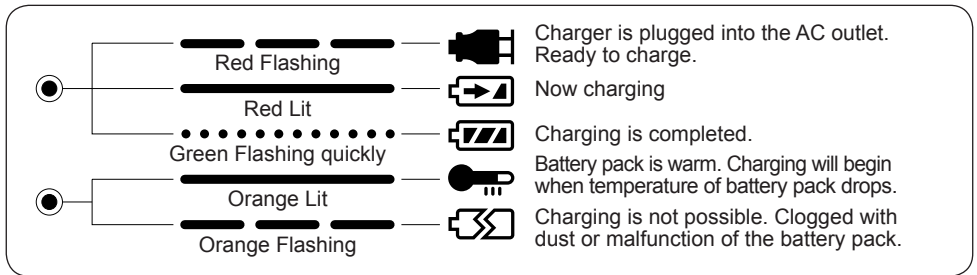

VIII. MAINTENANCE

Use only a dry, soft cloth for wiping the unit. Do not use a damp cloth, thinner, benzene, or other volatile solvents for cleaning.

BATTERY RECYCLING

ATTENTION:

FOR Ni-MH Battery Packs, EY9251

A nickel metal hydride battery that is recyclable powers the product you have purchased.

Please call **1-800-8-BATTERY** for information on how to recycle this battery.



IX. ACCESSORIES

Use only bits suitable for size of drill's chuck.

MAXIMUM RECOMMENDED CAPACITIES

EY6450		MATERIAL / CONDITION	SPEED
Screw driving	Wood screw	ø 4.2 mm (3/16") × 75 mm (3")	HIGH
	Self-drilling screw	ø 3 mm (1/8") × 13 mm (1/2") SPC t = 1.6 mm (1/16")	HIGH
Drilling	Wood	ø 50 mm (2") Yellow pine t = 38 mm (1-1/2")	LOW
	Metal	ø 13 mm (1/2") SPC t = 1.6 mm (1/16")	HIGH

X. SPECIFICATIONS

MAIN UNIT

Model		EY6450
Motor		DC Motor 18 V
No load speed	LOW	70 ~ 430 /min (rpm)
	HIGH	240 ~ 1500 /min (rpm)
Chuck capacity		ø 0.5 ~ ø 13 mm (0 ~ 1/2")
Clutch stage	Stage1-15	Approx. 2 Nm, (20 kgf-cm, 18 in-lbs)~ 12 Nm, (122 kgf-cm, 106 in-lbs)
		For powerful driving and drilling.
Overall length		250 mm (9-13/16")
Weight (with battery pack)		2.6 kg, (5.7 lbs)

BATTERY PACK

Model	EY9251
Storage battery	Ni-MH Battery
Battery voltage	18V DC (1.2V × 15 cells)

BATTERY CHARGER

Model		EY0110					
Electrical rating		See the rating plate on the bottom of the charger.					
Weight		0.78 kg, (1.72 lbs.)					
Charging time		7.2V	9.6 V	12V	15.6V	18V	24V
	1.2Ah	EY9065 EY9066	EY9080 EY9086	EY9001 EY9006			
		20min.					
	1.7Ah		EY9180 EY9182	EY9101			
		25min.					
	2.0Ah	EY9168		EY9106	EY9136		EY9117
	30min.		30min.			60min.	
3.0Ah			EY9200	EY9230		EY9210	
			45min.			90min.	
3.5Ah			EY9201	EY9231	EY9251		
			55min.		65min.		

NOTE: This chart may include models that are not available in your area.
Please refer to the catalogue.

30-DAY QUALITY SATISFACTION GUARANTEE:

If you are dissatisfied with any Panasonic Cordless Power Tool for any reason, simply return it to the place of purchase with a dated proof of purchase, in the original packaging, with all accessories, parts and instructions, within 30 days of the date of purchase, for a full refund, or call Panasonic at 201-392-6655. Abuse or misapplication of any power tool voids the guarantee.

PANASONIC CONSUMER ELECTRONICS COMPANY

One Panasonic Way, Secaucus, New Jersey 07094