

- The VN-900/1800/3600 has three recording modes: HQ (High Quality) mode, SP (Standard Playback) mode, and LP (Long Playback) mode.
- The Variable Control Voice Actuator (VCVA) reduces memory usage by pausing recording when it senses silence.
- Four folders, each of which can contain a maximum of 100 recorded messages.
- Jogdial layout and liquid crystal display enable easy operation.

DIGITAL VOICE RECORDER

VN-900 VN-1800 VN-3600

US/GB INSTRUCTIONS

Please read these instructions for information about using the product correctly and safely.
Keep the instructions handy for future reference.

To ensure successful recordings, we recommend that you test the record function and volume before use.

Identification of Parts

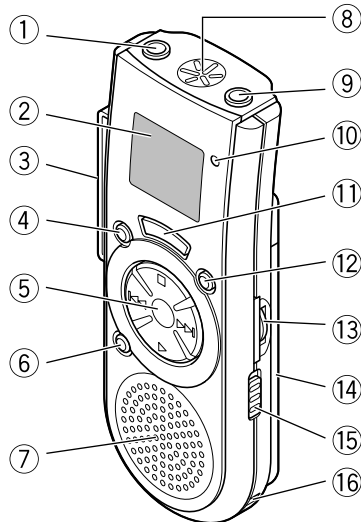

- 1 Earphone jack (EAR)
- 2 Display (LCD panel)
- 3 Clip
- 4 DISPLAY button
- 5 Jogdial
- 6 ERASE button
- 7 Built-in speaker
- 8 Microphone
- 9 Microphone jack (MIC)
- 10 Recording/playing lamp (VN-3600/1800 only)
- 11 REC (Record) button
- 12 MENU/FOLDER button
- 13 VOLUME control
- 14 Battery cover
- 15 Hold switch
- 16 Strap holes (Strap not included)

Jogdial

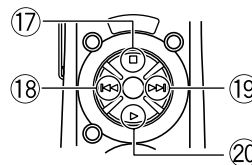

- 17 STOP button
- 18 ◀◀ (Rewind) /- button
- 19 ▶▶ (Fast Forward) /+ button
- 20 PLAY button

Display (LCD Panel)

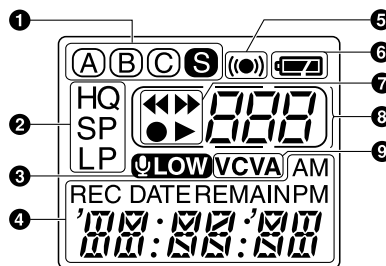

- 1 Folder indicator
- 2 Recording mode indicator
- 3 Microphone sensitivity display (LOW)
- 4 Current time/date, recording time/date (REC DATE), elapsed recording time, remaining recording time (REMAIN), menu display, etc.
- 5 Alarm indicator
- 6 Battery indicator
- 7 ◀◀ Rewind indicator, ▶▶ Fast Forward indicator, ● Record indicator, ▶ Play indicator
- 8 File number indicator
- 9 VCVA (Variable Control Voice Actuator) indicator

Standby Mode and Display Shut Off

If the recorder is stopped or paused for 60 minutes or longer during recording or playing, it goes into Standby (power-save) mode, and the display shuts off. To exit Standby mode and turn on the display, press any button.

OLYMPUS OPTICAL CO., LTD.

San-Ei Building, 22-2, Nishi Shinjuku 1-chome, Shinjuku-ku, Tokyo, Japan. Tel. 03-3340-2211

OLYMPUS AMERICA INC.

Two Corporate Center Drive, Melville, NY 11747-3157, U.S.A. Tel. 1-888-553-4448

OLYMPUS OPTICAL CO (EUROPA) GMBH.

(Premises/Goods delivery) Wendenstrasse 14-18, 20097 Hamburg, Germany. Tel. 040-237730
(Letters) Postfach 10 49 08, 20034 Hamburg, Germany.

OLYMPUS OPTICAL CO. (U.K.) LTD.

2-8 Honduras Street, London EC1Y 0TX, United Kingdom, Tel. 020-7253-2772

<http://www.olympus.com>

USA RFI

This equipment has been tested and found to comply with the limits for a Class B digital device, pursuant to part 15 of the FCC Rules. These limits are designed to provide reasonable protection against harmful interference in a residential installation. This equipment generates, uses and can radiate radio frequency energy and, if not installed and used in accordance with the instructions, may cause harmful interference to radio communications. However, there is no guarantee that interference will not occur in a particular installation. If this equipment does cause harmful interference to radio or television reception, which can be determined by turning the equipment off and on, the user is encouraged to try to correct the interference by one or more of the following measures:

- Reorient or relocate the receiving antenna.
- Increase the separation between the equipment and receiver.
- Connect the equipment into an outlet on a circuit different from that to which the receiver is connected.
- Consult the dealer or an experienced radio/TV technician for help.

Canadian RFI

This digital apparatus does not exceed the Class B limits for radio noise emissions from digital apparatus as set out in the Radio Interference Regulations of the Canadian Department of Communications.

Cet appareil numérique ne dépasse pas les limites de Catégorie B pour les émissions de bruit radio émanant d'appareils numériques, tel que prévu dans les Règlements sur l'Interférence Radio du Département Canadien des Communications.

CE "CE" mark indicates that this product complies with the European requirements for safety, health, environment and customer protection.

CE L'indication "CE" signifie que ce produit est conforme aux exigences concernant la sécurité, la santé, l'environnement et la protection du consommateur.

CE Das „CE“ Zeichen bestätigt die Übereinstimmung mit den Europäischen Bestimmungen für Betriebssicherheit und Umweltschutz.

CE Il marchio "CE" indica che questo prodotto è conforme alle norme della comunità europea per quanto riguarda la sicurezza, la salute, l'ambiente e la protezione del consumatore.

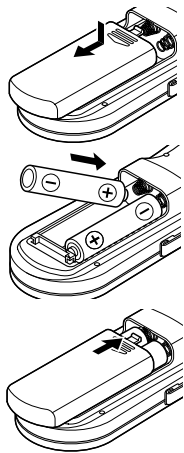

CE La marca "CE" indica que este producto se encuentra de conformidad con las exigencias europeas sobre seguridad, salud, medio ambiente y protección al consumidor.

Inserting Batteries



- 1 Lightly press down on the arrow and slide the battery cover open.
- 2 Insert two size-AAA alkaline batteries, observing the correct polarity.
- 3 Close the battery cover completely. Time/Date screen appears. The hour indicator flashes, indicating the start of the Time/Date setup process. (See "Setting Time/Date" for details)

Replacing Batteries

When  appears on the display, replace the batteries as soon as possible. Size-AAA alkaline batteries are recommended. When the batteries are depleted,  appears on the display, and the recorder shuts off. It is recommended to set the HOLD switch to the HOLD position before you replace batteries to maintain the current settings (time/date, etc.). For your convenience, the recorder also logs the current settings in nonvolatile memory at hourly intervals.

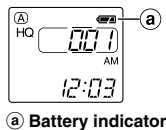

(a) Battery indicator

Setting Time/Date (TIME)

If you have set the time and date, information as to when a sound file was recorded is stored automatically with that file. The time and date must be set to enable management of files in folder S, for the alarm playback function, and for the scheduled alarm playback function.

When you install batteries for the first time or each time you replace the batteries, the hour indication will flash. In such a case, be sure to set the time and date by following steps 4 through 6 described below.

- 1 Press and hold the MENU/FOLDER button for 1 second or longer.
- 2 Press the ►►/+/ or ◀◀/- button until "TIME" flashes on the display.
- 3 Press the PLAY button. The hour indicator flashes.
- 4 Press the ►►/+/ or ◀◀/- button to set the hour.
- 5 Press the PLAY button to accept the hour. The minute indicator flashes. Repeat steps 4 and 5 to continue to set the minute, year, month and date in the same way.
- 6 After setting the date, press the STOP button. This completes the time/date setup procedure.

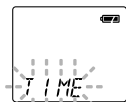

You can switch the time indication between the 12-hour system and the 24-hour system by pressing the DISPLAY button while you are setting the hour or minute. (Example: 5:23 P.M.)

5:23 PM ↔ 17:23
(Initial setting)

You can change the order of the date indication by pressing the DISPLAY button while you are setting the year, month, or day. (Example: February 14, 2001)

2.1401 → 14.2'01 → 01.2.14
(Initial setting)

Each time you press the DISPLAY button while the recorder is stopped, the display changes as follows (with folder A, B or C selected):
Time → Remaining recording time → Date → Time . . .
The selected indication appears on the display each time the recorder is stopped.

Notes

- If you leave the recorder untouched for 3 minutes or longer before pressing the STOP button in step 6, Setup mode will be canceled, and any time/date settings you made will be canceled.
- If you press the STOP button during setup, time/date setup is canceled.

Notes on the Folders

The recorder has four folders: A, B, C, and S.
To switch between folders, press the MENU/FOLDER button while the recorder is stopped.
Each time you press the MENU/FOLDER button, the display changes as follows:
A → B → C → S → A . . .

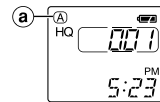

(a) Current folder

- Folders A, B, and C
Each recorded file is stored in a folder. Using folders to classify files makes it convenient to find files you want to access later.
- Folder S
This folder has date subfolders* from January 1 to December 31. Up to 15 files can be stored in each date subfolder, a useful feature for schedule management by storing a certain day's schedule for future reference.
To switch between date subfolders, select the S folder, then press the ►►/+/ or ◀◀/- button while the recorder is stopped.
Up to a total of 100 files can be recorded in folder S.
* There is one subfolder for each day of the year.

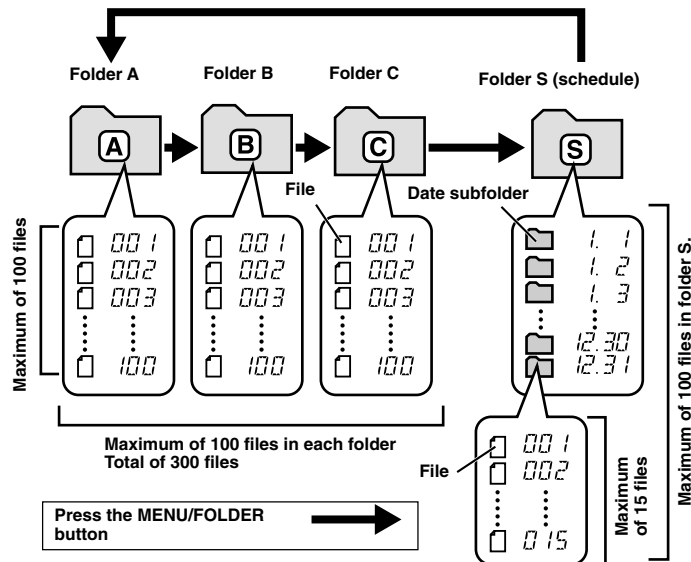

Recording (REC)

New recordings are saved as the last file in the folder. For example, if you have eight recordings in the Folder A, and you press REC, the new recording will be recording number nine.

- 1 Press the MENU/FOLDER button to select the desired folder (A, B, C or S).
When you select folder S, the current date subfolder appears on the display.
If you select folder A, B, or C, go to step 3.
- 2 If you select folder S, press the ►►/+/ or ◀◀/- button to select the desired date subfolder.
- 3 Set the recording mode (see "Recording Modes").
- 4 Set the microphone sensitivity (see "Microphone Sensitivity").
- 5 Press the REC button to start recording.

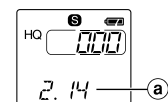

(a) Date to record

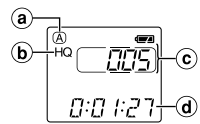

(b) Folder, (c) Current recording mode, (d) Current file number

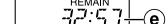

(e) Remaining recording time

- The Recording/playing lamp lights, and recording starts.
- If the recorder is placed directly on a table when recording a meeting, it tends to pick up table vibrations. Put a notebook or other item between the table and the recorder for clearer recording.
- The Record/Play display lamp will turn red while recording.

Each time you press the DISPLAY button, the display switches between current recording time and remaining recording time.

- 6 To stop recording, press the STOP button.

Notes

- When the remaining recording time becomes 5 minutes or less, the display changes to remaining recording time automatically.
- Even if you press the DISPLAY button, the display will not change to current recording time if the remaining recording time is 5 minutes or less.
- When remaining recording time falls to 1 minute or less, the Recording/playing lamp flashes.
- If "FULL" appears on the display, you cannot record in the selected folder. In such a case, erase unnecessary files (see "Erasing from folder A, B or C" or "Erasing from folder S").
- There is one subfolder for each day of the year.

To Pause Recording

To pause

Press the REC button during recording. ➡ "PAUSE" appears on the display and the Recording/playing lamp flashes.

To resume recording

Press the REC button again. ➡ Recording will resume at the point of interruption.

Note

The recorder will enter Stop mode if it has been left paused for 10 minutes or longer.

To check the remaining recording time

Press the DISPLAY button while the recorder is stopped.

To check the total number of files recorded in the folder

Press and hold the STOP button while the recorder is stopped. The total number of files recorded in the folder appears on the display.

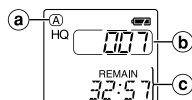

- a Current folder
- b Total number of files recorded in the current folder
- c Remaining recording time

Playing Back (PLAY)

1 Press the MENU/FOLDER button to select the desired folder (A, B, C or S).

2 Press the ►►/+/ ◀◀/- button to select the file to play back.

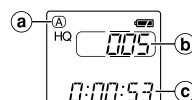

- a Current folder
- b Current file number
- c Playing time**

If you select folder S, select the desired date subfolder.*

* When you select the desired date subfolder, it is useful to press and hold the ►►/+/ ◀◀/- button for 1 second or longer. The recorder locates the next date subfolder that contains recorded files.

3 Press the PLAY button to start playback.

The playing time** appears on the display.

** Each time you press the DISPLAY button during playback, the display changes as follows: Playing time → Remaining playing time → Recording date of the file → Recording time of the file → Playing time . . .

4 Use the VOLUME control to adjust the volume to your liking.

The Record/Play display lamp will turn green while playing back (VN-1800/3600 only).

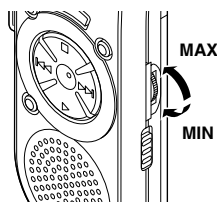

Note

When you play back a file in the date subfolder without choosing a specified file, the recorder will play back all the files in the selected date subfolder from filename "001". When you play back a file immediately after recording the file, only the most recently recorded file will be played back.

Canceling Playback

To stop

Press the STOP button. ➡ The recorder stops in the middle of the file being played.

To resume playback

Press the PLAY button again. ➡ Playback will resume at the point of interruption.

Playback Functions

	Operation	How to cancel
Fast Playback (F-PLAY)	Press and hold the PLAY button for 1 second or longer in Stop mode or while playing a file.	If you press the PLAY button again, the recorder will resume normal playback.
Fast Forward (►►)	Press and hold the ►► button while playing a file.	When you release the ►► button, the recorder will resume normal playback.
Rewind (◀◀)	Press and hold the ◀◀ button while playing a file.	When you release the ◀◀ button, the recorder will resume normal playback.

- Fast playback is approximately 30% faster than normal playback.
- When fast playback of a file is over, the recorder will play back the next file at normal speed. If you once press the STOP button and start playback again, the recorder will play back files in normal speed as well.
- No sound is heard from the built-in speaker during fast forwarding or rewinding.
- The end of the file is located by pressing and holding the ►► button during fast forwarding. The recorder will pause at the end of the file. If you do not release the ►► button, the recorder will continue fast forward.
- The beginning of the file is located by pressing and holding the ◀◀ button during rewinding. The recorder will pause at the beginning of the file. If you do not release the ◀◀ button, the recorder will continue rewinding.

Locating the beginning of the file

Press the ►►/+/ ◀◀/- button in Stop mode,* playback mode, or fast playback mode.

Each time you press the ►►/+/ ◀◀/- button, the recorder will locate the beginning of the next or previous file.

* When folder S is selected, you cannot locate the beginning of the file in Stop mode.

Notes

- Even if you press the ►►/+/ ◀◀/- button during playback or fast playback, the recorder will continue playback in the same playback mode.
- When you select folder A, B or C you can locate the beginning of each file continuously by pressing and holding the ►►/+/ ◀◀/- button while in Stop mode. During operation, "SKIP" flashes on the display.

Listening with earphones (You can use any standard 3.5mm monaural earphone or headphone)

You can listen to files by connecting earphones to the earphone jack.

- If an earphone is connected, the speaker doesn't emit sound. Sound will be played back monaurally.

Note

Do not turn the volume up very high when listening through earphones. Doing so may cause poor sound quality and can impair hearing.

Erasing from Folder A, B or C

You can easily erase unnecessary files. Sequential file numbers are reassigned automatically.

Erasing One File at a Time

1 Press the MENU/FOLDER button to select folder A, B, or C.

2 Press the ►►/+/ ◀◀/- button to select the file to be erased.

3 Press the ERASE button.

The file number flashes, then alternatively "ERASE" and "YES" appear on the display for 8 seconds.

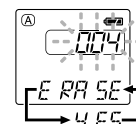

4 Press the ERASE button again.

The file is erased.

You can erase a file while you are playing it back.

Note

If you leave the recorder untouched for 8 seconds or longer before you press the ERASE button in step 4, Erase mode will be canceled, and the recorder will enter Stop mode.

Erase All Files from a Folder

1 Press the MENU/FOLDER button to select the folder from which you want to erase all files.

2 Press and hold the ERASE button for 2 seconds or longer.

The folder name and "ALL" flash, then alternatively "ERASE" and "YES" appear on the display for 8 seconds.

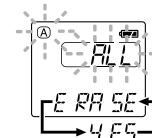

3 Press the ERASE button again.

All files in the selected folder are erased simultaneously.

Note

If you leave the recorder untouched for 8 seconds or longer before you press the ERASE button in step 3, Erase mode will be canceled, and the recorder will enter Stop mode.

Erasing from Folder S

Erasing One File at a Time in a Date Subfolder

- Press the MENU/FOLDER button and select folder S.
- Press the ►►I/+ or I/◄◄- button to select the date subfolder.
- Press the PLAY button.
The recorder starts to playback all the files in the selected date subfolder.
- During playback, press the ►►I/+ or I/◄◄- button to select the file to be erased.
- Press the STOP button.
- Press the ERASE button.
The file number flashes, then alternatively "ERASE" and "YES" appear on the display for 8 seconds.
- Press the ERASE button again.
The file is erased.
Sequential file numbers are reassigned automatically.

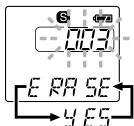

Note
If you leave the recorder untouched for 8 seconds or longer before you press the ERASE button in step 7, Erase mode will be canceled, and the recorder will enter Stop mode.

Erase All Files in a Date Subfolder

- Press the MENU/FOLDER button to select folder S.
- Press the ►►I/+ or I/◄◄- button to select the date subfolder to be erased.
- Press and hold the ERASE button for 2 seconds or longer.
"ALL" flashes, then alternatively the date of the selected subfolder and "YES" appear on the display for 8 seconds.
- Press the ERASE button again.
All files in the date subfolder are erased.

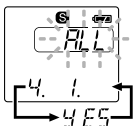

Note
If you leave the recorder untouched for 8 seconds or longer before you press the ERASE button in step 4, Erase mode will be canceled, and the recorder will enter Stop mode.

Erase All Files in the S Folder

- Press the MENU/FOLDER button to select folder S.
- Press and hold the ERASE button for 4 seconds or longer.
"S" and "ALL" flash, then alternatively "ERASE" and "YES" appear on the display for 8 seconds.
- Press the ERASE button again.
All files in folder S are erased.

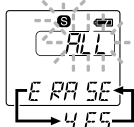

Note
If you leave the recorder untouched for 8 seconds or longer before you press the ERASE button in step 3, Erase mode will be canceled, and the recorder will enter Stop mode.

Recording Modes (MODE)

You can select from among three recording modes: HQ (High Quality) mode, SP (Standard Playback) mode and LP (Long Playback) mode.

	VN-900	VN-1800	VN-3600
HQ mode	Approx. 22 min.	Approx. 45 min.	Approx. 91 min.
SP mode	Approx. 33 min.	Approx. 67 min.	Approx. 137 min.
LP mode	Approx. 90 min.	Approx. 180 min.	Approx. 364 min.

The recording time shown above is for one continuous file. The available recording time may be shorter than specified if several files are recorded. (Use the remaining time and recorded time only as references.)

- Press and hold the MENU/FOLDER button for 1 second or longer.
The menu opens, and "MODE" appears on the display.
- Press the PLAY button.
- Press the ►►I/+ or I/◄◄- button to choose a recording mode.

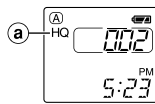
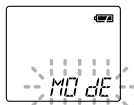

a Current recording mode

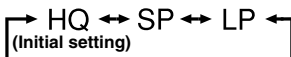

Note
In case of difficult acoustic conditions or low speaker's voice, recording in HQ or SP is recommended. Also, usage of an external microphone (sold separately) could improve the quality of recordings.

Microphone Sensitivity (MIC)

Microphone sensitivity is adjustable to meet your recording needs.

- Press and hold the MENU/FOLDER button for 1 second or longer.
Go to the Menu screen.
- Press the ►►I/+ or I/◄◄- button until "MIC" flashes on the display.
- Press the PLAY button.
- Press the ►►I/+ or I/◄◄- button to select between "LO" and "HI".
LO: Low-sensitivity mode suited for dictation.
HI: High-sensitivity mode that records sounds in all directions.
- Press the STOP button to close the menu.
If you choose LO, **LOW** will appear on the display.

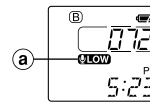
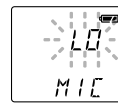
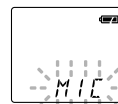

a Microphone sensitivity display

Notes

- To ensure successful recording, make a test recording to choose appropriate microphone sensitivity before recording.
- If you choose HI, we recommend setting the recording mode to HQ or SP to best take advantage of the higher sensitivity.
- If you choose HI, background noise may be high depending on the recording conditions.

Moving Files Between Folders (MOVE)

You can move files recorded in folders A, B and C to other folders. The moved file is added at the end of the destination folder.

- Choose the file you want to transfer and press the PLAY button to play it.
- Press and hold the MENU/FOLDER button for 1 second or longer while the file is playing.
Playback stops, and "MOVE" flashes on the display.
- Press the ►►I/+ or I/◄◄- button to choose a destination folder.
The destination folder and new file number appear after moving.
- Press the PLAY button.
The destination folder and the number of the moved file appear on the display, and moving is completed.

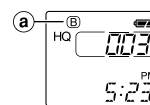

a Destination folder
b Destination number of the file

Notes

- You cannot move files between folder S and the other folders.
- If the destination folder is full (100 files), "FULL" appears on the display, and you cannot move the file to that folder.

Using the Variable Control Voice Actuator (VCVA)

When the microphone senses that sounds have reached a preset volume, the built-in Variable Control Voice Actuator (VCVA) starts recording automatically, and stops it when the volume drops.

Particularly helpful for extended recording, the VCVA not only conserves memory by turning off recording during silent periods, but also makes playback more efficient and convenient.

- Press and hold the MENU/FOLDER button for 1 second or longer.
The menu opens.
- Press the ►►I/+ or I/◄◄- button until "VCVA" flashes on the display.
- Press the PLAY button.
- Press the ►►I/+ or I/◄◄- button to select between "On" and "OFF".
On: The VCVA is activated.
OFF: The VCVA is canceled.
- Press the STOP button to close the menu.
- Press the REC button to start recording.

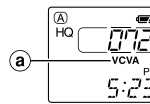

a VCVA indicator

Notes

- When the VCVA senses sound louder than its start/stop actuation level setting, recording starts automatically. When it senses silence for 1 second or longer, recording pauses automatically, and the recorder enters Standby mode.
- The Recording/playing lamp is lit during recording. When the recorder is in Standby mode, the Recording/playing lamp flashes and "VCVA" flashes on the display.

Alarm Playback Function (ALARM)

The alarm playback function can be set to play a selected file at a preset time. Up to 20 alarms can be set.

- 1 Choose the file to be played when the alarm sounds.
- 2 Press and hold the MENU/FOLDER button for 1 second or longer.
- 3 Press the ►►/+/ or ◀◀/– button until “ALARM” flashes on the display.
- 4 Press the PLAY button.
The month indicator flashes.
- 5 Press the ►►/+/ or ◀◀/– button to set the month.
- 6 Press the PLAY button to register your month setting.
Continue to set the date, hour, and minute.
- 7 Set the minute and press the STOP button.
An alarm will sound at the scheduled time for 5 minutes. Press any button other than the DISPLAY button while the alarm is sounding to play back the file you associate with the alarm.
Press the STOP button to stop file alarm playback.

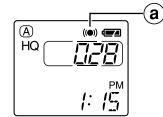
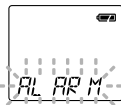

a Alarm indicator

Notes

- The alarm tone stops automatically if no button is pressed within 5 minutes after the alarm starts. The file is not played back in this case.
- After alarm playback is over, the alarm playback function is canceled automatically.
- If no files are recorded in the selected folder, you cannot set the alarm playback function.
- You cannot set the year of the file to be played.

To cancel an alarm playback

- 1 Repeat steps 1 to 4 in “Alarm Playback Function.”
The month indicator flashes.
- 2 Press the ►►/+/ or ◀◀/– button to select the month of the alarm you want to cancel.
- 3 Press the PLAY button to register this month setting for alarm cancellation.
Continue to select the date, hour and minute of the desired alarm cancellation.
When you set the minute, “On” flashes on the display.
- 4 Press the ►►/+/ or ◀◀/– button to select “OFF.”
A set alarm playback is canceled.
- 5 Press the STOP button to close the menu.

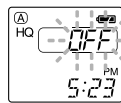

Schedule Alarm Playback Function (SALARM)

This is useful for reviewing your daily appointments and reminders.

- 1 Press and hold the MENU/FOLDER button for 1 second or longer.
- 2 Press the ►►/+/ or ◀◀/– button until “S” and “ALARM” flash on the display.
- 3 Press the PLAY button.
- 4 Press the ►►/+/ or ◀◀/– button to select “On.”
- 5 Press the PLAY button.
The hour indicator flashes.
- 6 Press the ►►/+/ or ◀◀/– button to select the hour.
- 7 Press the PLAY button to register the hour.
Continue to set the minute.
- 8 Set the minute and press the STOP button.
An alarm will sound at the scheduled time for 5 minutes. Press any button other than the DISPLAY button while the alarm is sounding to play back all files recorded in the day's date subfolder.
To stop schedule alarm playback, press the STOP button.

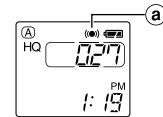
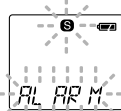

a Alarm indicator

Notes

- The alarm tone stops automatically if no button is pressed within 5 minutes after the alarm starts. The files recorded for the current date are not played back in this case.
- Schedule alarm playback occurs every day unless it is set to OFF.
- Even if no file is recorded in the day's date subfolder, the beeps will sound. In such a case, no sound is heard even if you press some button while the alarm is sounding.

To cancel schedule alarm playback

- 1 Repeat steps 1 to 3 in “Schedule Alarm Playback Function.”
“On” flashes on the display.
- 2 Press the ►►/+/ or ◀◀/– button to select “OFF.”
Schedule alarm playback is canceled.
- 3 Press the STOP button to close the menu.

System Sounds (BEEP)

The recorder beeps to alert you to button operations or warn you of errors. If you wish to disable the system sounds, proceed as follows:

- 1 Press and hold the MENU/FOLDER button for 1 second or longer.
- 2 Press the ►►/+/ or ◀◀/– button until “BEEP” flashes on the display.
- 3 Press the PLAY button.
- 4 Press the ►►/+/ or ◀◀/– button to choose between “On” and “OFF.”
On: System sounds are enabled.
Off: System sounds are disabled.
- 5 Press the STOP button to close the menu.



Note

If the alarm playback function or the schedule alarm playback function has been set, the alarm will sound at the scheduled time even if the system sounds are disabled.

Settings

- 1 Press and hold the MENU/FOLDER button for 1 second or longer while the recorder is stopped.
- 2 Press the ►►/+/ or ◀◀/– button to select what you would like to set up.
The item to be set will change every time the ►►/+/ or ◀◀/– button is pressed.

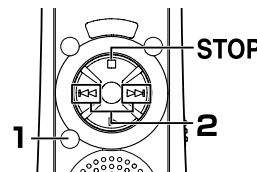

- ① *MODE* Recording mode setting. Switch among HQ, SP, and LP modes.
- ② *MIC* Microphone mode setting. Switch between HI and LO modes.
- ③ *VCVA* VCVA setting. Switch between On (enabled) and OFF (disabled)
- ④ *AL ARM* Alarm playback setting. Switch between On (enabled) and OFF (disabled)
- ⑤ *AL ARM* Scheduled Alarm setting. Switch between On (enabled) and OFF (disabled)
- ⑥ *BEEP* System sounds setting. Switch between On (enabled) and OFF (disabled)
- ⑦ *TIME* Time/Date setting. In order of hour, minute, year, month and day.

Closing the Menu Screen

Press the STOP button.

Clip

How to Use the Clip

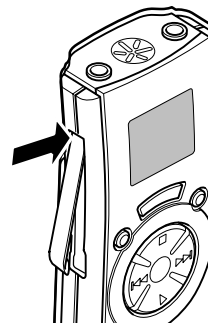

- Press the area that the arrow points to.
- Do not force the clip wider, as it may break.

Hold

Set the HOLD switch to the HOLD position.

All operation buttons are disabled. This feature is useful when the recorder has to be carried in a handbag or pocket.

Remember to reset the HOLD switch before attempting to use the recorder.

Notes

- The alarm will sound at the scheduled time even if the recorder is set to HOLD. The recorder will then begin to play the file associated with the alarm once you press any button.
- The recorder functions as follows with the HOLD switch set to the HOLD position:
 - If the recorder is stopped, the display goes dark.
 - If the recorder is playing, the display goes dark when playback of the current file has completed.
 - When you set the HOLD switch to the HOLD position while playing back, you can still adjust the volume using the VOLUME control.
 - If the recorder is recording, the display goes dark when the recorder stops recording automatically upon running out of free memory.

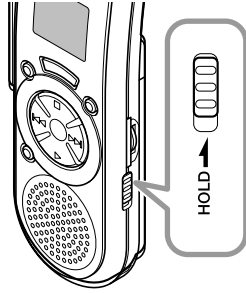

Resetting the Recorder (CLEAR)

This function resets the current time and other settings to their initial status.

It is useful if you are having problems with the recorder, or if you want to erase the entire memory of the recorder.

- Hold the STOP button, and hold the ERASE button for 2 seconds or longer. "CLEAR" and "YES" appear alternately on the display for 8 seconds.



- Press the ERASE button again.

All files in all folders are erased, and the recorder is reset to its default settings.

Note

If you leave the recorder untouched for 8 seconds or longer before you press the ERASE button in Step 2, Clear mode will be canceled, and the recorder will enter Stop mode.

For Safe And Correct Usage

Read this manual carefully to ensure that you know how to operate it safely and correctly. Keep this manual in an easily accessible location for future reference.

- The warning symbols indicate important safety related information. To protect yourself and others from personal injury or damage to property, it is essential that you always heed the warnings and information provided.

General Precautions

- Do not leave the recorder in hot, humid locations such as inside a closed automobile under direct sunlight or on the beach in the summer.
- Do not store the recorder in places exposed to excessive moisture or dust.
- Do not use organic solvents such as alcohol and lacquer thinner to clean the unit.
- Do not place the recorder on top of or near electric appliances such as TVs or refrigerators.
- Avoid sand or dirt. These can cause irreparable damage.
- Avoid strong vibrations or shocks.
- Do not disassemble, repair or modify the unit yourself.
- Do not operate the unit while operating a vehicle (such as a bicycle, motorcycle, or go-cart).
- Keep the unit out of the reach of children.

Batteries

⚠ Warning

- Batteries should never be exposed to flame, heated, short-circuited or disassembled.
- Do not attempt to recharge alkaline, lithium or any other non-rechargeable batteries.
- Never use any battery with a torn or cracked outer cover.
- Keep batteries out of the reach of children.
- If you notice anything unusual when using this product such as abnormal noise, heat, smoke, or a burning odor:
 - remove the batteries immediately while being careful not to burn yourself, and;
 - call your dealer or local Olympus representative for servicing.

Troubleshooting

Q1 Nothing happens when a button is pressed.

- A1
- The HOLD button may be set to HOLD.
 - The batteries may be depleted.
 - The batteries may be inserted incorrectly.

Q2 No sound or quiet sound is heard from the speaker while playing back.

- A2
- The earphone plug may be plugged into the recorder.
 - The volume may be set to the minimum level.

Q3 Recording is not possible.

- A3
- The remaining recording time in the selected folder may have reached "0m00s".
 - The number of recorded files in the selected folder may have reached 100.
 - The number of files of the same date in folder S may have reached 15.

Q4 The playback speed is too fast.

- A4
- The recorder may be set to Fast Playback.

Q5 The remaining recording time seems too short.

- A5
- Some files may be stored in the S folder. Hold the stop button while in the S folder. The display will show the total number of recordings in the S folder.

Q6 You cannot move the file.

- A6
- The number of recorded files in the destination folder may have reached 100.
 - Make sure that you haven't transferred to or from the S folder.

Specifications

Recording medium:	Built-in flash memory
Recording time:	<u>VN-900 (8 MB)</u> HQ mode: Approx. 22 min. SP mode: Approx. 33 min. LP mode: Approx. 90 min. <u>VN-1800 (16 MB)</u> HQ mode: Approx. 45 min. SP mode: Approx. 67 min. LP mode: Approx. 180 min. <u>VN-3600 (32 MB)</u> HQ mode: Approx. 91 min. SP mode: Approx. 137 min. LP mode: Approx. 364 min.
Speaker:	Built-in ø 28 mm round dynamic speaker
Maximum power:	120 mW
Earphone jack:	ø 3.5 mm diameter, impedance 8 Ω
Power supply:	Two AAA (LR03 or R03) batteries
Continuous battery use time:	About 33 hours (use of alkaline batteries, measured value for continuous recording according to the specifications of our company)
Dimensions:	96 (L) × 39 (W) × 21.5 (T) mm
Weight:	60 g including batteries

- * The continuous battery use time may be reduced according to the battery type and the use conditions.
- * Your recorded contents are for your personal use or pleasure only. It is prohibited to record copyrighted material without permission of the copyright holders according to copyright law.
- * Specifications and design are subject to change without notice for improvement of performance.

Accessories (Optional)

Connecting cord (Earphone jack ↔ Microphone jack) : KA232*
Connecting cord (Mini miniplug → Miniplug) : PA3
Noise-Cancellation microphone : ME12
Electret condenser microphone : ME10
Headset : E99
Conference microphone : ME7
Telephone pickup : TP6

Accessories marked* should be used in combination with the PA3 plug adapter.