

Owners Manual

Öhlins shock absorbers, Motorcycle Road & Track



Including:

Safety

Tuning the
suspension

Design
features

Function

Basic
adjustments

Fine tuning

Inspection
maintenance



Safety signals

Important information concerning safety is distinguished in this manual by the following notations:



*The Safety alert symbol means:
Caution! Your safety is involved.*

WARNING!

*Failure to follow warning instructions could result in **severe or fatal injury** to anyone working with, inspecting or using the suspension, or to bystanders.*

CAUTION!

Caution indicates that special precautions must be taken to avoid damage to the suspension.

NOTE!

This indicates information that is of importance with regard to procedures.

Introduction

All of Öhlins advanced suspension products are adapted to the brand and model. This means that length, travel springaction and damping characteristics, are tested individually just for the motorcycle that you have decided to fit with Öhlins suspension.

Before installation

Öhlins Racing AB can not be held responsible for any damage whatsoever to shock absorber or vehicle, or injury to persons, if the instructions for fitting and maintenance are not followed exactly.

Similarly, the warranty will become null and void if the instructions are not adhered to.

Contents

| | |
|---|----|
| Safety signals | 2 |
| Tuning the suspension | 3 |
| Design | 3 |
| Function | 4 |
| Compression damping | 4 |
| Rebound damping | 4 |
| Settings | 5 |
| Basic settings | 5 |
| Setting the spring preload | 5 |
| Measuring | 5 |
| Adjusting | 6 |
| Front fork spring | 6 |
| Setting the damping | 7 |
| Setting the shock absorber length | 7 |
| Setting your motorcycle | 8 |
| Start with rebound damping | 8 |
| Compression damping | 8 |
| Adjusting the shock absorber length | 9 |
| Inspection and maintenance | 10 |

WARNING!

1. Installing a shock absorber, that is not approved by the vehicle manufacturer, may affect the stability of your vehicle. Öhlins Racing AB cannot be held responsible for any personal injury or damage whatsoever that may occur after fitting the shock absorber. Contact an Öhlins dealer or other qualified person for advice.

2. Please study and make certain that you fully understand all the mounting instructions and the owners manuals before handling this shock absorber kit. If you have any questions regarding proper installation procedures, contact an Öhlins dealer or other qualified person.

3. The vehicle service manual must be referred to when installing the Öhlins shock absorber

NOTE

Öhlins products are subject to continual improvement and development. Consequently, although these instructions include the most up-to-date information available at the time of printing, there may be minor differences between your suspension and this manual. Please consult your Öhlins dealer if you have any questions with regard to the contents of the manual.

© Öhlins Racing AB.

All rights reserved.

Any reprinting or unauthorized use without the written permission of Öhlins Racing AB is prohibited.

Printed in Sweden.

1. Design principles

1. Emulsion shock absorber
2. Internal gas reservoir
3. External piggyback reservoir
4. External reservoir with hose connection

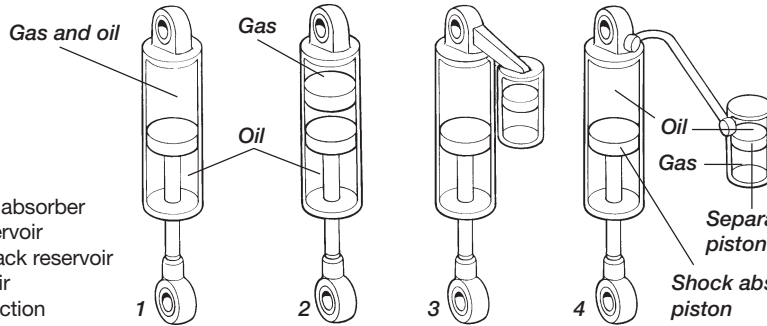

2. Spring preloading

Mechanical adjustment Hydraulic preloader

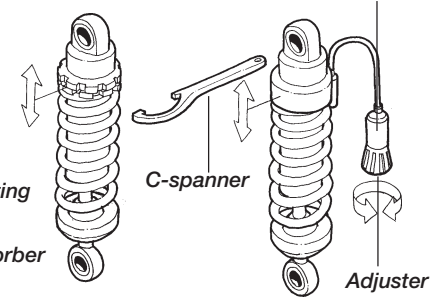

Tuning the suspension

Motorcycle road holding qualities

All motorcycles are designed with a suspension geometry that includes height and fork angle. The changing of components can affect this and it is therefore essential that both the rear and the front ends match each other.

Changing to Öhlins suspension gives optimum performance only when both the front fork and the rear suspension interact properly. It is of the greatest importance that the front and rear loaded height are within the specified values. See section: Setting the spring preload.

Design

Most of the Öhlins shock absorbers are of the De Carbon type. The fluid is put under gas pressure and the gas and the fluid are kept apart by a separating piston. The separating piston is often fitted in a separate fluid chamber, connected by hose, or fixed direct on top of the shock absorber (piggyback).

There are also types of shock absorbers where everything is fitted inside the main cylinder tube (internal gas reservoir), and even a small number of emulsion shock absorbers that do not have a separating piston. Pressurization of the fluid is made with nitrogen. The pressurization prevents cavitation of the fluid and the shock absorbing action is therefore more even. The external reservoirs also contribute to better cooling of the fluid, giving longer service life for both the fluid and components.

Öhlins shock absorbers have integrated temperature compensation. As the temperature increases, and the fluid flows more easily the flow is

controlled accordingly. The shock absorbing effect is therefore independent of the temperature.

The more advanced models permit individual adjustment of compression damping and rebound damping, and also certain adjustment of the length of the shock absorber.

Öhlins shock absorbers provide the possibility for adjustment, making them adaptable to most motorcycles, riders and ranges of use. All of the shock absorbers have adjustable preloading of the spring action; either mechanically or hydraulically.

3. Flow through needle valve

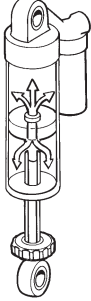

4. Piston with apertures

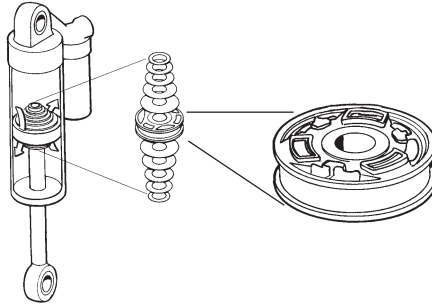

5. Shims stack

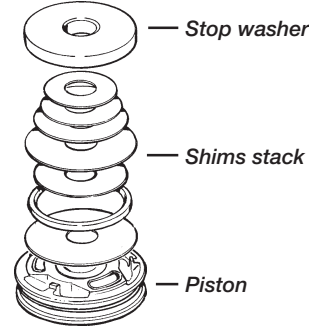

6. Flow through piston

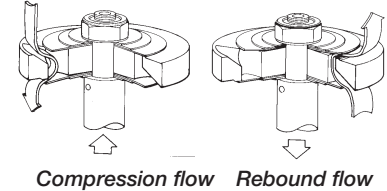

Function

The function, in principle, is that fluid is forced through needle valves at a low rate of flow (Fig.3) and through a number of apertures in the piston (Fig.4) at a high rate of flow. The flow through these apertures is regulated by shims (thin steel washers, Fig.5) that at high pressure are deflected to open for the fluid. On most models the needle valves can be set individually.

By altering the size of the shims stack (ie, number, thickness, diameter) the characteristics of the damping action can be varied (this shall only be done by Öhlins authorized service workshops).

Compression damping

When movement of the motorcycle causes compression in the shock absorber, the fluid flows through the needle valve (combined compression and return valve) in the piston rod. If velocity of the piston is high, ie, in the case of rapid compression, this will not be sufficient and consequently the shims underneath the piston will open to allow a greater rate of flow (Fig.6).

The fluid that is displaced by the volume of the piston rod is forced into the external fluid chamber via a separate compression valve. Even this valve is fitted with shims that open at high piston velocity. The separating piston is displaced, thus increasing the gas pressure.

Rebound damping

When the spring presses the shock absorber out again, the fluid flows back through the needle valve in the piston rod. The fluid flowing into the chamber is forced by the pressure of the gas back into the shock absorber via a separate non return valve.

If velocity of the piston is high, the shims on top of the piston will also open to allow the fluid to flow through (Fig.6).

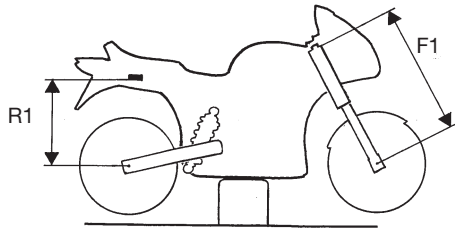

A-D. Bike on a stand.

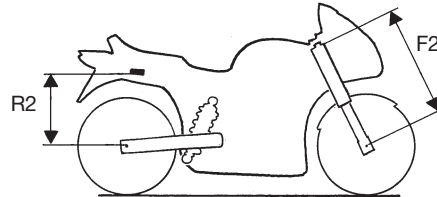

E. Bike on the ground.

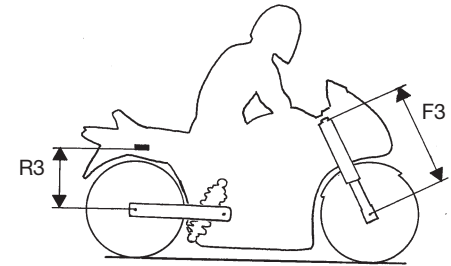

F. Bike with rider on.

Settings

Basic settings

Always ensure that the basic setting made by Öhlins is correct. It is adapted to the make and model (in its original state) and for a rider of average weight.

Everything must harmonize

In the recommendation table there are Öhlins front fork springs that are specifically adapted to the shock absorbers recommended to your motorcycle. If none is noted in the table then “intact” original springs is the right choice. Incorrect spring action can give a fork angle that is too steep or too flat. This in turn will give a tendency for oversteering or understeering, which could seriously affect the handling characteristics of the motorcycle.

Setting the spring preload

Measuring:

Preload on the spring/springs is very important, because it affects the height of the motorcycle and the fork angle. Consequently, handling characteristics can be changed, even negatively.

Proceed as follows (it will be much easier if done by two persons):

- A** Place the motorcycle on a stand.
- B** Lift up the rear end to a fully extended position.
- C** Measure the distance, eg, from the lower edge of the rear mud guard or from a point marked by a piece of tape, immediately above the rear wheel axle, to the wheel axle. (R1)
- D** Make a similar measurement on the front axle, e.g., from the bottom of the upper fork crown to the front wheel axle. The fork must also be fully extended. (F1)

E Allow the motorcycle (without rider) to apply load on the springs and repeat the measuring procedure. (R2, F2)

F Then take the same measurements with the rider and equipment on the motorcycle. It is important that the rider has a correct riding posture, so that the weight is balanced on the front and rear wheel in the same way as when riding. (R3, F3)

The measurements may not differ from the following sizes:

Without rider:

| | | |
|--------|----------|---------|
| Rear: | 5-10 mm | (R1-R2) |
| Front: | 25-30 mm | (F1-F2) |

With rider:

| | | |
|--------|----------|---------|
| Rear: | 30-40 mm | (R1-R3) |
| Front: | 35-48 mm | (F1-F3) |

7. Spring preload adjustment.

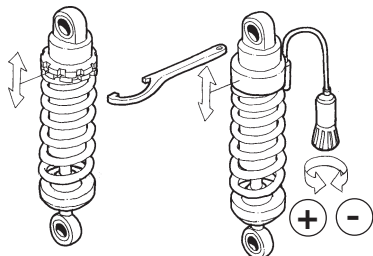

**A. Mechanical
preload adjuster**

**B. Hydraulic
preload adjuster**

Adjusting

Adjust the preload with the rings on the shock absorber or by hydraulic preloading. In the first case, hold the upper ring and adjust the lower one to the desired position (Fig.7A). Then lock with the upper ring.

For hydraulic preloading, increase by turning clockwise and reduce by turning counter clockwise (Fig.7B).

NOTE!

On shock absorbers that have mechanical type adjustment the position of the adjusting/preload rings can be adjusted. On a shock absorber that has hydraulic setting the basic position can be adjusted. Such changes should be attended to by an Öhlins authorized service workshop.

The original setting of the shock absorber, when delivered from Öhlins, should always be a base when the settings are changed by use of the adjustment devices.

NOTE!

The spring preload affects the ride height, it does not affect the spring stiffness.

Therefore, on models with a linkage to the shock absorber, the suspension may actually feel harder when you reduce the preload and the shock absorber gets into the harder range of the link system.

8. Front fork spring kit

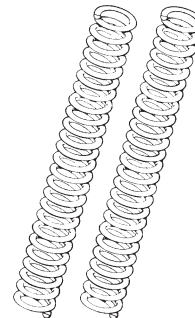

Front fork springs

To optimize the road holding qualities of a motorcycle the front fork must match the rear suspension.

Öhlins springs are available for a large number of motorcycles (Fig.8). These, in combination with Öhlins shock absorbers, contribute to superior road holding qualities. The original make of springs should be used if there are none of our springs in the recommendation table. However, they must be in good condition and not fatigued. Remember to change the fluid in the front fork at least once every year.

We recommend Öhlins front fork oil. See table.

NOTE!

It is important that the recommendation table is followed for new front springs. If there are no recommended front springs you must ensure that the existing springs are in good condition. Neglecting to check the front springs could seriously affect the handling qualities of the motorcycle.

9. Adjustment of rebound damping

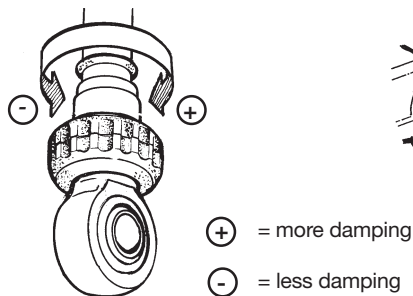

10. Adjustment of compression damping

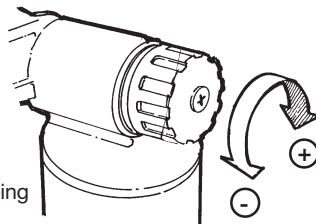

11. High and low speed compression damping adjusters

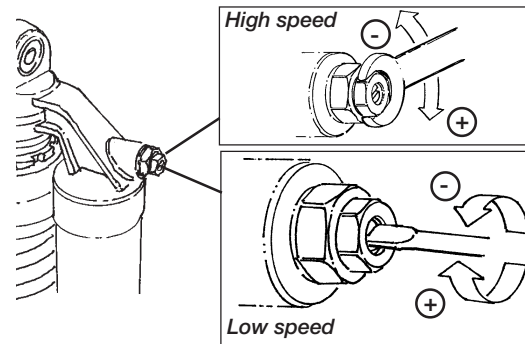

Setting the damping

The adjusting possibilities of Öhlins shock absorbers facilitate fine setting. You can optimize adjustments to suit your own weight and equipment, your individual way of riding and the condition of the road. To be able to improve the road holding qualities it is of the utmost importance that you fully understand the functioning of the shock absorbers. Then you can learn by trial and error how they affect the motorcycle.

Depending on the model there are adjustments for rebound damping, compression damping and adjustment of the length of the shock absorber. Damping is set with the knobs, they have a normal right hand thread. By turning clockwise they increase the damping action and counter clockwise they reduce it. The knobs have definite positions with noticeable "clicks", so it is easy to count to the right setting.

Rebound damping action affects the characteristics of the motorcycle most. The setting knob is located at the bottom on the piston rod (Fig.9).

It can be adjusted in about 40 steps. The compression damping knob is located at the end of the reservoir (Fig.10). This can be adjusted in about 25 steps.

Some models (PRX) have separate adjusters for high speed compression and low speed compression (Fig.11). The low speed compression is adjusted in 25 steps.

The high speed adjuster has a wide range within about 48 clicks

NOTE!

High and low speed refers to the shaft velocity of the shock absorber. It is not necessarily related to the speed of the vehicle.

NOTE!

When making new adjustments it is easiest to go back to fully closed, and then count forward to the new setting. The adjusting knobs should not be screwed in too hard.

NOTE!

If no "click" is felt, the shock absorber must be inspected by an authorized service workshop. It could be due to incorrect or lack of gas pressure.

12. Rebound damping

- Unstable
- Loose
- Bouncy

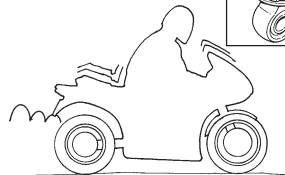
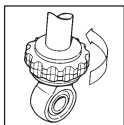

Increase

- Hard
- Bumpy

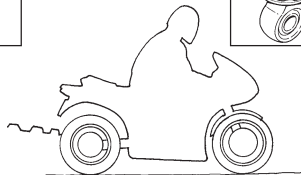
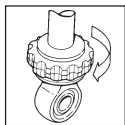

Reduce

13. Compression damping

- Unstable
- Soft
- Low
- Bottom

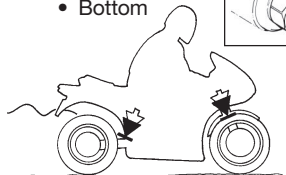
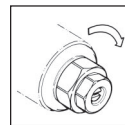

Increase

- Harsh
- Hard
- Bad grip

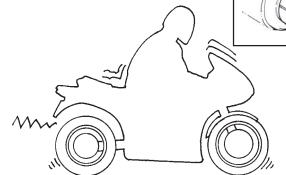
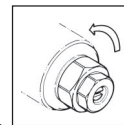

Reduce

Setting your motorcycle

NOTE!

Always begin with the basic settings recommended by Öhlins. Always make notes, adjust in small steps and make only one adjustment at a time. Adjustments should be made with two steps (clicks) at a time. Adjustments should not be more than four steps from the basic setting.

By utilizing the adjustment possibilities you can test by trial and error, and learn how they affect your motorcycle.

Always begin by test riding the motorcycle with all adjustments at their i.e. delivery setting. Choose a short run of varying character, ie, long and sharp bends, hard and soft bumps. Keep to the same run and adjust only one setting at a time.

Start with the rebound damping (Fig.12)

If the motorcycle feels unstable, loose and rather bouncy then the rebound damping should be increased. Begin by turning the adjusting knob 4 steps (clicks) clockwise. Test run again and adjust two steps back if it felt too hard and bumpy.

If the motorcycle is hard and bumpy, especially over a series of bumps, then the rebound damping should be reduced. Turn counter clockwise 4 steps, test run and make any necessary correction to 2 steps.

Compression damping (Fig.13)

The low speed compression adjuster affects ride height, smoothness over small bumps and grip. The high speed compression adjuster affects stability, firmness in depressions and fast corners.

If the motorcycle has low riding position, the low speed compression should be increased. Screw clockwise four steps and test run again. If this was too much then turn back two steps

(counter clockwise). If it feels unsmooth over small continuous bumps or has bad grip, the low speed compression should be decreased. Turn counter clockwise four steps. Test run and make any necessary correction in two steps at the time.

If the motorcycle feels unstable in fast corners and has a tendency to bottom easily in depressions and chicanes, the high speed compression should be increased. Screw clockwise six steps and test run again. If this was too much then turn back three steps (counter clockwise). If it feels harsh and too rigid or has a tendency to hop under braking, the high speed compression should be decreased. Turn counter clockwise six steps. Test run and make any necessary correction in three steps at the time.

When you have sufficient feel of the motorcycle you can make further fine adjustments. It is feeling and experience that counts.

14. Adjustment of shock absorber length

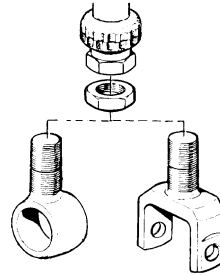

15. Adjusting the shock absorber length

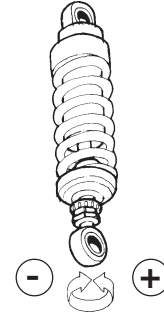

NOTE!

Ensure that the springs are properly preloaded before attempting to make any adjustments. A simple rule is that increased preload of the spring should be followed by an increase of rebound damping by two steps.

When you feel that you have achieved an improvement, go back to where you started and check once more. Be observant of other relevant factors such as tyres, temperature, etc. Test run to make sure whether further fine adjustment should be made.

Setting the shock absorber length

Sensitivity of the steering can be adjusted by altering the length of the shock absorber, without affecting other characteristics. The length is adjusted using two nuts down and the threaded clevis at the end of the piston rod (Fig.14). The shock absorber can be adjusted up to 12 mm.

Adjusting the shock absorber length

A long shock absorber results in steeper inclination of the front fork (steeper fork angle) and consequently sensitive, quicker steering. A short shock absorber gives a bigger angle of the front fork (flat fork angle) and consequently slower and smoother steering. Each complete turn of the shock absorber gives one millimetre (Fig.15). The length may never be altered more than to where the groove (Fig.16) that is cut in the thread becomes just visible under the lower nut of the level bracket. Make small steps and test run.

16. Groove

⚠ WARNING!

If the shock absorber has an adjustable end eye/bracket, this must not be threaded out more than that one groove is fully visible beneath the lock nut. Make sure that the lock nut is tightened after adjustment.

Groove

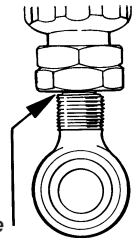

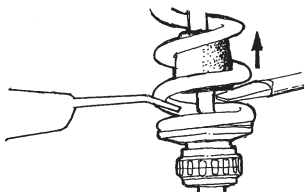

17. Lift the bump rubber and clean the area below.

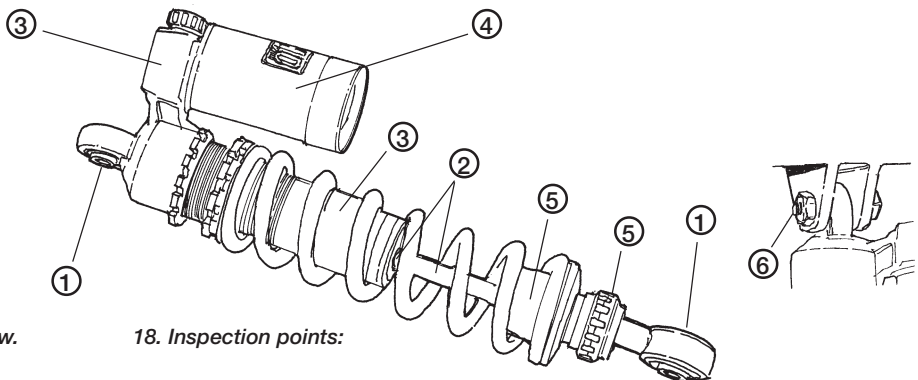

18. Inspection points:

Inspection and maintenance

Clean the shock absorbers externally with a soft detergent. Use compressed air. Lift the bump rubber and clean the area below (Fig.17). Keep the shock absorbers clean and always spray them with oil (QS 14, WD40 or CRC 5-56 or similar).

CAUTION!

Never use detergents that can damage the surfaces of the shock absorber. Thinner and brake cleaner will dry the surfaces too much.

Inspection points: (Fig.18)

- 1 Check ball joints for possible excessive play.
- 2 Check the piston shaft for leakage and damage
- 3 Check the shock absorber body and for external damage.
- 4 Check the external reservoir for damages that can restrict the floating piston from moving freely.
- 5 Excessive wear of rubber components.
- 6 Fastening to the vehicle.
 - Check the hose equipped models for leaks in hose and inlet plugs.

Preventive maintenance and regular inspection reduces the risk of functional disturbance. If there is any need for additional service, please get in touch with an authorized Öhlins service workshop. There they have the necessary tools and know how for whatever you need.

NOTE!

Make certain that your shock absorbers are always filled with Öhlins High Performance Suspension fluid.

NOTE!

Regular maintenance and inspection contribute to the prevention of functional disturbances.

Recommended service intervals:

| | |
|-------------|------------------------|
| Race track | Every 10 hours |
| Street/Road | Every 20 000-30 000 km |

⚠ WARNING!

Never alter the gas pressure. Special purpose charging equipment and access to nitrogen is required. The gas pressure should normally never be altered.

⚠ WARNING!

The shock absorber is provided with a separate type reservoir filled with high pressure nitrogen gas. To prevent danger of explosion, study and make certain that you fully understand the following information before handling the shock absorber. The manufacturer cannot be held responsible for damage to property or personal injury that may result from improper handling.

- 1. Never tamper with or attempt to disassemble the cylinder or the reservoir.*
 - 2. Never expose the shock absorber to an open flame or other excessive heat. The shock absorber may otherwise explode due to too high pressure.*
-

3. Be careful not to damage any part of the gas reservoir. A damaged gas reservoir will impair the damping performance or cause malfunction.

4. Take care not to scratch the contact surface of the piston rod of the cylinder, oil could otherwise leak out.

5. Never attempt to remove the plug at the bottom of the nitrogen gas reservoir. Any attempt to remove the plug implies serious danger.

6. When scrapping the shock absorber, follow the instructions for disposal.

More info

www.ohlins.com

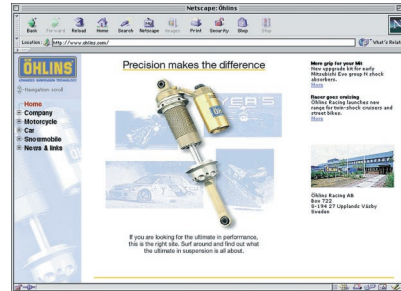

The ultimate suspension site.
Find out everything about your suspension.
Download mounting instructions, manuals and brochures.
And a lot more.



Öhlins Racing AB, Box 722, S-194 27 Upplands Väsby, Sweden
Phone +46 8 590 025 00, Fax +46 8 590 025 80

Your Öhlins dealer: