

**NCT<sup>®</sup> 100T**

**NCT<sup>®</sup> 990T**

**NCT<sup>®</sup> 2000T**

**Controls for Lathes**

**Operator`s Manual**

Valid from software version x.057

---

Produced and developed by **NCT Automation kft.**

H1148 Budapest Fogarasi út 7

✉ Letters: H1631 Bp. pf.: 26

☎ Phone: (+36 1) 467 63 00

☎ Fax:(+36 1) 363 6605

E-mail: [nct@nct.hu](mailto:nct@nct.hu)

Home Page: [www.nct.hu](http://www.nct.hu)

# Contents

<b>Introduction</b> .....	<u>7</u>
<b>1 Operator's Panel</b> .....	<u>8</u>
1.1 The NC Control Panel: Display Unit and Data Input Keyboard .....	<u>8</u>
1.1.1 Data Input Keyboard .....	<u>10</u>
1.1.2 Information Displayed in General Displaying Area and the Status Bar .....	<u>11</u>
1.1.3 Indication of Ready Status of Control .....	<u>13</u>
1.2 Machine Control Board .....	<u>13</u>
<b>2 General Operating Knowledge</b> .....	<u>17</u>
2.1 Screen Menu .....	<u>17</u>
2.2 Action Menu .....	<u>19</u>
2.3 Data Input .....	<u>19</u>
<b>3 General Displaying Areas and Actions Executed on Them</b> .....	<u>21</u>
3.1 POSITION Screens .....	<u>22</u>
3.2 CHECK Screens .....	<u>24</u>
3.2.1 PROGRAM TEXT Screen, Listing of Running Program .....	<u>24</u>
3.2.2 FUNCTION Screen, Subprogram and Macro Levels .....	<u>24</u>
3.2.3 LAST and ACTIVE screens. G Codes and Compensations. ....	<u>25</u>
3.2.4 OPERATOR'S PANEL Screen .....	<u>26</u>
3.2.5 MESSAGES Screen .....	<u>29</u>
3.3 PROGRAM Screens .....	<u>30</u>
3.3.1 DIRECTORY Screen .....	<u>30</u>
3.3.2 VIEW Screen .....	<u>32</u>
3.3.3 EDIT Screen .....	<u>33</u>
3.3.4 BLOCK INPUT .....	<u>34</u>
3.4 OFFSETS Screens .....	<u>35</u>
3.4.1 WORK OFFSETS Screen .....	<u>35</u>
3.4.2 TOOL OFFSETS Screen .....	<u>36</u>
3.4.3 WORK OFFSET MEASURE Screen .....	<u>39</u>
3.4.4 TOOL LENGTH OFFSET MEASURE Screen .....	<u>40</u>
3.4.5 RELATIVE POSITION OFFSETS Screen .....	<u>41</u>
3.5 GRAPHIC POSITION Screens .....	<u>42</u>
3.5.1 GRAPHIC PARAMETERS Screen .....	<u>42</u>
3.5.2 DRAW Screen .....	<u>44</u>
3.6 SETTING Screens .....	<u>46</u>
3.6.1 Screen of LOCAL MACRO VARIABLES .....	<u>46</u>
3.6.2 Screen of COMMON MACRO VARIABLES #100-#199 .....	<u>47</u>
3.6.3 Screen of COMMON MACRO VARIABLES #500-#599 .....	<u>48</u>
3.6.4 TIMER AND COUNTER Screen .....	<u>49</u>
3.6.5 TOOL POT TABLE Screen .....	<u>49</u>
3.6.6 PLC TABLE Screen .....	<u>51</u>
3.6.7 USER'S PARAMETERS Screen (User's Params) .....	<u>52</u>
3.6.8 SECURITY PANEL Screen .....	<u>53</u>
<b>4 Editing Part Programs</b> .....	<u>56</u>

4.1 Structure of Part Program .....	<u>56</u>
4.2 Division of EDIT Screen during Editing .....	<u>57</u>
4.3 Basic Editing Functions: Typing, Cursor Moving, Delete, Insert, Select .....	<u>59</u>
4.4 Editor Action Menu .....	<u>62</u>
4.5 File Actions: Save, Save as .....	<u>62</u>
4.6 Edit Actions: Undo, Cut, Copy, Paste, Find and Replace .....	<u>62</u>
4.7 Insert Actions .....	<u>64</u>
4.8 Actions of Window .....	<u>64</u>
4.9 Help .....	<u>65</u>
<b>5 Switching Over Operation Modes .....</b>	<b><u>66</u></b>
<b>6 Manual Operation Modes .....</b>	<b><u>67</u></b>
6.1 Manual Reference Point Return Mode .....	<u>67</u>
6.2 Jog Mode .....	<u>69</u>
6.3 Incremental Jog Mode .....	<u>71</u>
6.4 Manual Handle Mode .....	<u>73</u>
<b>7 Actions Executed in Manual Operation Modes .....</b>	<b><u>75</u></b>
7.1 Single Block Operation .....	<u>75</u>
7.2 Work Zero Point Offset and Tool Length Offset Measurement .....	<u>75</u>
7.2.1 Work Zero Point Offset Measurement .....	<u>76</u>
7.2.2 Tool Length Offset Measurement inside the Machine .....	<u>79</u>
7.2.3 Automatic Tool Length Offset Measurement .....	<u>81</u>
7.2.4 Calibrating Tool Offset Sensor .....	<u>82</u>
<b>8 Modes of Automatic Operation .....</b>	<b><u>85</u></b>
8.1 Automatic Mode .....	<u>85</u>
8.1.1 Program Execution in DNC .....	<u>85</u>
8.2 Edit Mode .....	<u>87</u>
8.3 Manual Data Input Mode .....	<u>88</u>
<b>9 Override Switches .....</b>	<b><u>90</u></b>
9.1 Feedrate Override Switch .....	<u>90</u>
9.2 Rapid Traverse Override Switch .....	<u>91</u>
9.3 Spindle Speed Override Switch .....	<u>91</u>
<b>10 Program Execution Start and Stop .....</b>	<b><u>93</u></b>
10.1 Starting Program Execution .....	<u>93</u>
10.2 Feed Stop .....	<u>93</u>
10.3 RESET .....	<u>93</u>
10.4 Programmed Stop: M00 .....	<u>94</u>
10.5 Conditional Stop: M01 .....	<u>94</u>
10.6 End of Program: M02, M30 .....	<u>95</u>
<b>11 Intervention in the Course of Program Execution .....</b>	<b><u>96</u></b>
11.1 Conditional Block Skip .....	<u>96</u>
11.2 Increasing Feedrate by Means of Rapid Traverse Jog Button .....	<u>96</u>
11.3 Intervention by Means of Manual Handle in Automatic Operation .....	<u>97</u>
<b>12 Debugging the Part Program .....</b>	<b><u>99</u></b>

12.1 Single Block Execution	99
12.2 Dry Run (All Feedrates at High Speed)	99
12.3 Machine Lock Function	100
12.4 Other Locking Possibilities	100
12.5 Test Run	101
<b>13 Interruption and Restart of Automatic Operation</b>	<b>102</b>
13.1 Interruption of Automatic Operation	102
13.2 Restart of the Automatic Operation. Modal Information.	102
13.3 Unconditional Restart of Automatic Operation	104
13.4 Automatic Operation Restart with BLOCK RESTART Condition	109
13.4.1 Return to the Block Start Position by Means of Manual Operation	109
13.4.2 Return to Block Start Position in Automatic Mode	109
13.4.3 Cases of Return by Means of BLOCK RESTART Condition	110
13.5 Automatic Mode Restart with BLOCK RETURN Condition	113
13.5.1 Return to the Interruption Point by Means of Manual Operation	113
13.5.2 Return to the Interruption Point in Automatic Operation	113
13.5.3 Cases of Return by Means of Condition BLOCK RETURN	114
13.6 Automatic Operation Start after Block Search	117
13.6.1 Pointing at the Desired Block. Entering the Repetition Count.	117
13.6.2 Command SEARCH	118
13.6.3 Command GOTO	120
13.6.4 Search for INTERRUPTED Block	120
<b>14 Listing of Messages and their Codes</b>	<b>122</b>
14.1 Local Message	122
14.2 Global Messages	122
14.3 Listing of Global Messages	124
<b>Notes</b>	<b>143</b>
<b>Alphabetical index</b>	<b>144</b>

March 18, 2003

© Copyright **NCT** March 18, 2003

The Publisher reserves all rights for the contents of this Manual. No reprinting, even in extracts, is permissible unless our written consent is obtained. The text of this Manual has been compiled and checked with utmost care, yet we assume no liability for possible errors or spurious data and for consequential losses or damages.

---

## Introduction

Dear User,

Thank you for having opted for one of our **NCT100T**, **NCT990T**, or **NCT2000T** control systems. It is hoped sincerely that you will be always satisfied in your work with its facilities.

It should be remembered that the skill of operating the machine can only be learnt in the possession of the part programming fundamentals. Similarly, no programming is feasible unless the skills of machine operation are acquired.

***THE MACHINE CANNOT BE MANIPULATED OR OPERATED IN SAFETY UNLESS YOU CAN INTERPRET THE PART PROGRAM AND CHECK IT FOR CORRECTNESS!***

***THE OPERATOR OF THE MACHINE MUST ALWAYS FORESEE ALL CONSEQUENCES OF HIS/HER INTERVENTIONS!***

### Conditions of Operation and Storage

The control system may be operated at an ambient temperature between +10 and +50°C; **It must not be turned on at any other temperature.** The programs in the memory cannot be warranted for preservation if the control is stored at a temperature below +10°C. The storage temperature range is -10 to +50°C.

The control unit is cooled by one or two built-in fans. The fan with a filter, mounted on top of the electronic section, should produce a slight over-pressure inside the cabinet. It should be made sure that the external and the built-in fans are not working against each other. **The cleanliness of the filter of the external fan**, or if necessary, a replacement thereof is a basic condition for the faultless operation of the control system. **It is forbidden to open** the door of the cabinet of electronic section (or to disassemble the unit) for aeration or any other purpose while the control system is under power. It is also forbidden and involves the loss of the warranty to remove, repair or subsequently adjust the PC boards of the control system. The only exceptions are the replacements of the 1.6 and 6.3 fuses on the front panel of the PC board of the power supply, and setting the brightness control of the screen. Replacement of fuses can only be done if the tool machine is in power-off status.

## 1 Operator's Panel

### 1.1 The NC Control Panel: Display Unit and Data Input Keyboard

The NC control panel employs the **display unit** (monitor), the **softkeys** beneath, and the **data input** keyboard.

The **NCT100T**, **NCT990T** and the **NCT 2000T** control panels are available in different versions. The **monitor** can be **9" monochrome**, or **15" color**.

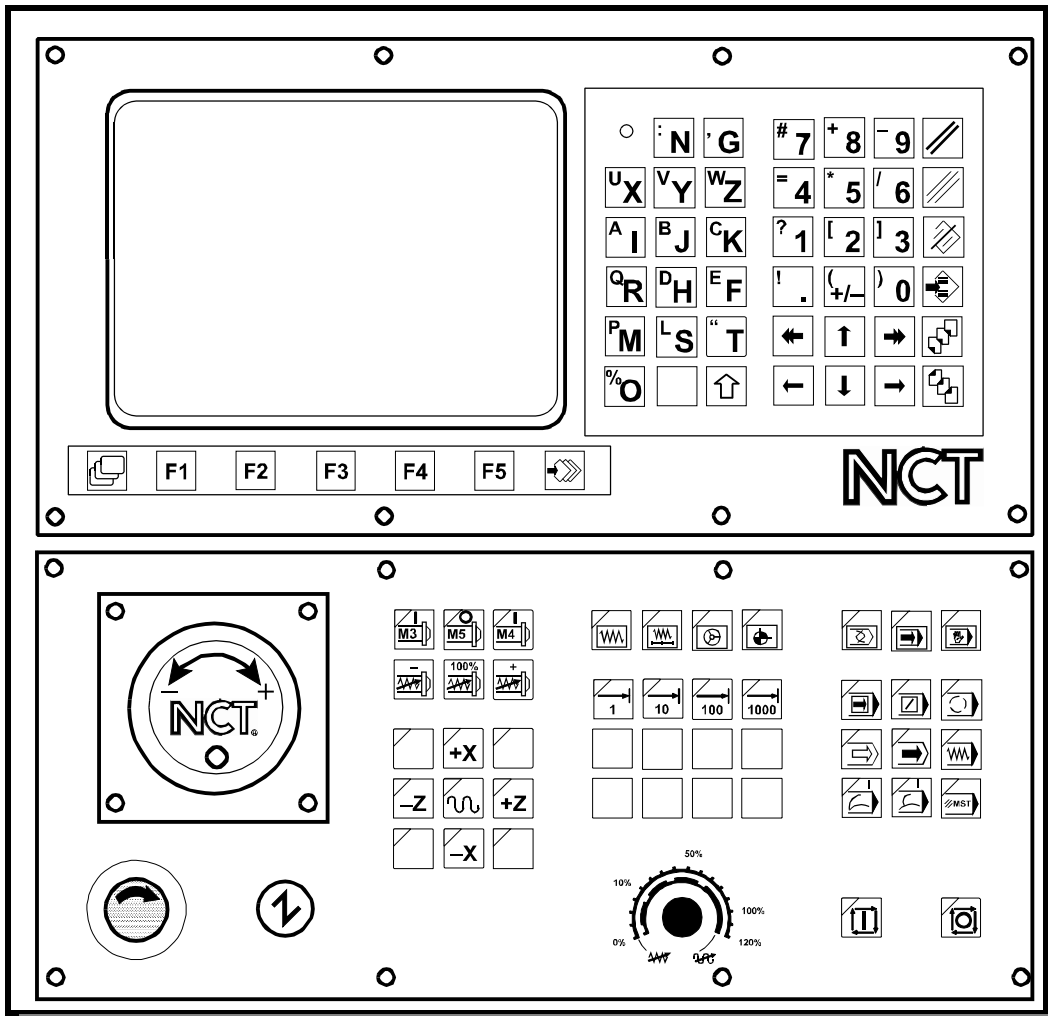

Operator's panel with 9" monochrome monitor and with optional Machine control board



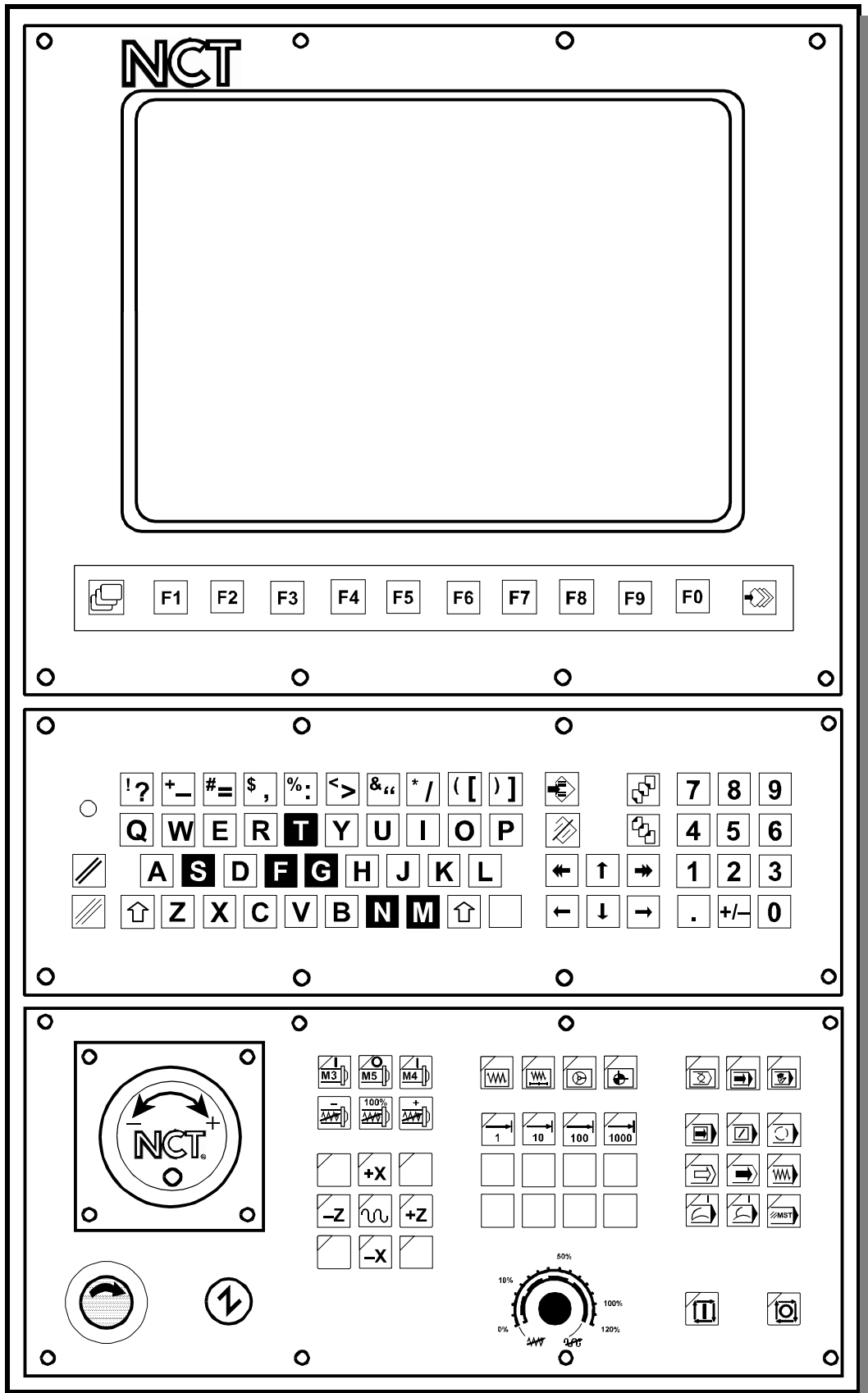



Operator's panel with 15" color monitor and with optional Machine control board

### 1.1.1 Data Input Keyboard

In case of a 9" monitor directly beneath the screen are five **softkeys**, in case of a 15" monitor ten softkeys built together with the screen. In both cases the meaning of these softkeys can be read in the menu bars found in the bottom line of screen, therefore their meanings may alter. However it is likely, that in some right-side menu bar there are no captions. This can only mean, that in that situation the softkeys have no function at all.

To the left of the first softkey is the

**screen menu** key , while to the right of the last softkey is the

**action menu** key . The meaning of these keys is permanent and serve for changing the meaning of softkeys.

The data- input keyboard may be found beneath or to the right of the monitor. The **LED "NC ready"** is placed on the data- input keyboard.

The main key groups found on data input keyboard are as follows::

*Delete keys:*

**RESET**  for deleting global and

**CANCEL**  for deleting local messages.



*Alphabetical keys:*

On the panel the **letters** of English alphabets, the **space** key without a caption as well as key **SHIFT**  can be found. In case key SHIFT is held down, and at the same time a letter key is pressed, the **symbol** indicated at the top left corner of the key appears.

*Numeric input keys:*

The numeric input keys (**digits, decimal point, sign reverser**) are beside the letters in a separate block that gathers up 3x4 keys.



*Scrolling and editing keys:*



Arrow keys  and  move the cursor on characters within a word.





When editing part programs (using EDIT screen) their meanings are:

 : **Enter** (Line Feed  $\text{LF}$ )

 : **Backspace**

Arrow keys  and  naturally move the cursor in the indicated direction on the address chain.

Arrow keys  and  move the cursor from one block to another in the indicated direction.

Keys <b>PgUp</b>		and
<b>PgDn</b>		are used for turning pages within the text.
Keys <b>INS</b>		and
<b>DEL</b>		serve for inserting and deleting characters.

*The above listed units (monitor and keyboard) constitute the permanent part of NC and are transported together with the control in any case of configuration.*

The NC keyboard is fitted with repeater-type keys. This means

- that a depressed key produces an immediate effect,
- that a held-down key produces an effect again after a programmed delay (Typematic Delay),
- that, with the key held down permanently, the appropriate code will be entered into the CPU of the system over and over again at a programmed rate (Typematic Rate).

The delay (TD) and the rate (TR) can be set with the help of *parameter 1121 TYPOMATIC* (for details see Parameters).

### 1.1.2 Information Displayed in General Displaying Area and the Status Bar

Information seen in general displaying area can be divided into 3 parts:

- in the bottom line are the fields of current captions of softkeys,
- above - in the middle of screen - is the general displaying area,
- while the top three lines form the status bar.

#### The Status Bar

The top three lines give a general outlook on the present status of control and machine tool. The content of this displaying area is permanent, no matter which general screening area is selected.

In the first line there are eight status fields. Each status field can only display logically connecting states. In case there are more states to be displayed in one status field (for there are simultaneously more state conditions), the last one in the list below is shown.

#### 1 State of First Operation Mode Group

- **MDI**: manual data input mode
- **AUTM**: automatic mode, program execution from memory
- **AUTD**: automatic mode, program execution from external device
- **EDIT**: edit mode

#### 2 State of Second Operation Mode Group

- **JOG**: jog mode
- **INCR**: incremental jog mode
- **HNDL**: manual handle feed mode
- **REF**: manual reference point return mode
- **SBEX**: execution of a single block

### **3 Functional State of Automatic and Manual Data Input**

- **NSCH:** block search
- **INTD:** automatic execution interrupted
- **STRT:** start state
- **STOP:** stop state

### **4 Program Manipulation State**

- **LOAD:** loading program from external device
- **SAVE:** saving program to external device
- **SORT:** sorting programs in directory is in progress
- **EDIT:** long-lasting edit operation
- **WFTG:** waiting for trigger
- **TRGD:** triggered
- **Exch:** change between general displaying areas is in progress
- **BURN:** burning into FLASH

### **5 Interpolator State**

- **MOV:** either axis moves (interpolator started)
- **DWL:** waiting specified by dwell G4
- **POS:** waiting for in position signal
- **1:** increment size is 1 increment
- **10:** increment size is 10 increment
- **100:** increment size is 100 increment
- **1000:** increment size is 1000 increment
- **feedrate:** feedrate value from table
- **DRUN:** dry run
- **HOLD:** feed hold state

### **6 PLC State**

- **FIN:** execution of a PLC function is in progress

### **7 Message Line State**

- **#\*@!:** # mirror, \* scaling, @ active rotation, and ! the common offset is not zero
- **OPRM:** operator's message in message line
- **PLC:** PLC message in message line
- **ALRM:** alarm message in message line
- **! !:** access forbidden
- **→←:** conflicting state

### **8 General NC State**

- **REF:** no reference point on an axis
- **TEST:** test mode
- **LOCK:** machine lock state
- **EMG:** emergency stop state
- **KYBD:** no connection to keyboard

In the second line is the **message field**. In this field the global messages, i.e. messages independent of the general displaying area, alarm messages of NC, PLC and macros as well as

the operator's messages of PLC are displayed. The **date** and **time display** can also be found in this line.

In the third line the **name of the active general displaying area** and behind the **number of programs** indicated for running can be read. In case of *manual data input* mode, the number of programs belonging to the manual data input can be seen here, otherwise the number of programs indicated for *automatic* mode is displayed.

### 1.1.3 Indication of Ready Status of Control

The light of the LED "NC ready" indicates the power-on and functional ready condition of the control system.

The LED will turn dark

- upon power-off of the control system,
- if the control breaks down,
- if the monitoring program (watchdog) of the control detects a malfunctioning or a fatal error.

*If the LED is dark, the control is out of service!*

### 1.2 Machine Control Board

The operation mode and functional state of the machine must be capable of being changed and the machining must be capable of being started and stopped. The buttons and switches influencing the function of the machine are called machine control items. The machine control items can be operated

- partly after selecting the appropriate general displaying area by means of softkeys on NC keyboard, or
- by means of buttons, switches installed separately.

A summary of the state of control items, the active mode ect. appears if the CONTROL PANEL screen is selected.

The machine control panel must contain primarily those operating items, that cannot be accessed from the data input keyboard by means of softkeys (e.g. START, STOP), or their access is hard. Certain items of the machine keyboard can make the intervention from data input keyboard through softkeys unnecessary. Of course the developed machine keyboard can also activate all, from data input keyboard through softkeys attainable machine control items. The case, whether an operating item is to be accessed from softkeys or only from machine control panel is determined by the machine tool builder as a function of the developed machine keyboard, so for details turn to him for an information material.

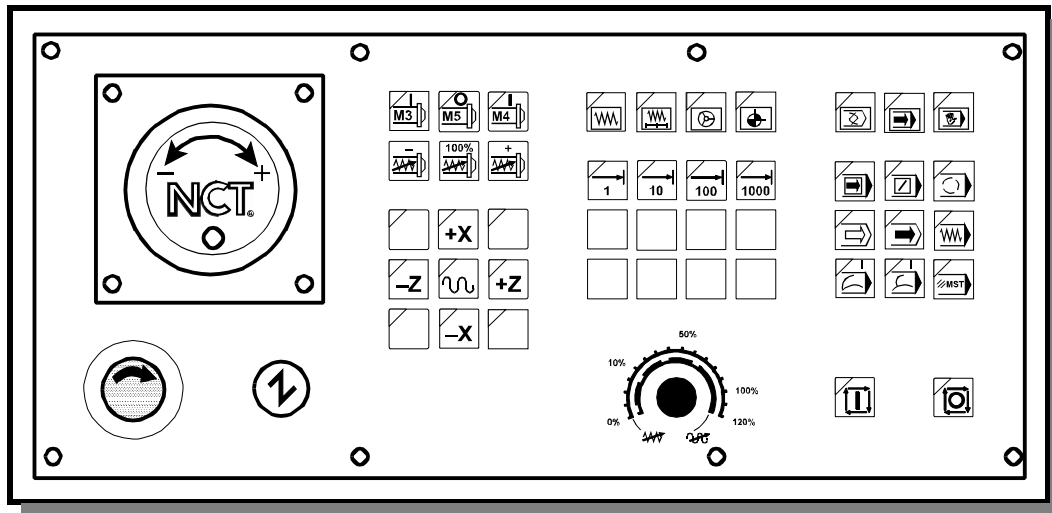

Optional machine control board

Below

the operating items of machine control board delivered by NCT are described. The lighting state of LED in the top left corner of buttons shows, that the function indicated by the key is active.

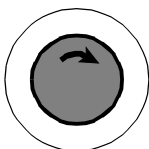

**Emergency stop.** By its depressing the NC registers the emergency stop state, shuts down all movements, and cuts its outputs off the machine. It can be undone by rotating the head of the button in the direction of the arrow. For more details of its functioning turn to the machine tool builder for an information material.



**Machine on** button. By affecting it, if the machine is not in emergency stop state (e.g. the emergency stop is not in held down state) the control and the machine link. Other parts of the machine, e.g., hydraulics, etc. come into effect. For more details about the power-on process of the machine turn to the machine tool builder.

**Operation mode selectors:**



Jog



Incremental jog



Manual handle



Manual reference point return



Edit

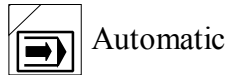

Automatic



Manual data input

**Increment selectors:**

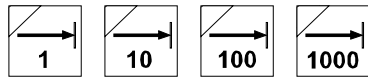

Selecting 1, 10, 100, 1000 increment size.

**Override switches:**

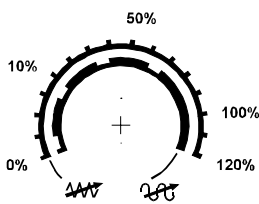

**Feedrate override** switch. By affecting it the programmed feedrate can be changed in the 0-120% range.

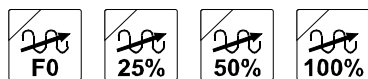

**Rapid traverse override** value can be influenced by four optionally supplied buttons.

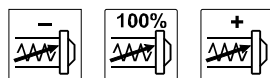

**Spindle speed override** buttons. By affecting <-> the programmed revolution is reduced, by affecting <+> it is increased by 10% in the 50-150% range. As the effect of button 100% the programmed revolution is acknowledged.

**Switches modifying the conditions of program execution:**



Single block execution



Conditional block skip



Conditional stop



Program test



Machine lock



Dry run



Block restart



Block return



Function lock

### Movement, start and stop buttons



**Start** button. Details of its functioning are discussed in the forthcoming chapters of the Manual.



**Stop** button. Details of its functioning are discussed in the forthcoming chapters of the Manual.



**Jog** buttons. Operators of jogging and incrementing. In case of running to reference point they serve for selecting axes. The arrangement of buttons can vary for machine types.



**Spindle start and stop** buttons. By affecting them the spindle starts to spin in CW direction (M3), or in CCW direction (M4), as well as stops to spin (M5).

Apart from these buttons the machine control panel contains **8 optionally used buttons** equipped **with LEDs** (with 4 optional rapid traverse override buttons among them), about which the machine tool builder decides, what function he chooses to build in. Also, a **manual handle** can be attached to the machine control panel.



## 2 General Operating Knowledge

### 2.1 Screen Menu

After turning the power on among the captions interpreting the softkeys the **screen menu** is active. On a color screen the default background color of the menu bar of the screen menu is light grey. In order to switch over from another menu to this, the **screen menu** key  must be pressed. The different screens can be selected in the screen menu by pressing the softkey with the appropriate caption. Actions (e.g., Data input) cannot be initiated from the screen menu, this menu is only for to switch over between screens. The screen menu is of two levels, in the first level the following screen menus can be found:

<b>Position</b>	Check	Program	Offsets	Graphic	Setting	Service			Page
1	2	3	4	5	6	7	8	9	10

If the appropriate screen within the screen menu is active, the caption of the menu field is highlighted, otherwise the caption is dark (black). After turning the power on the *ABSOLUTE POSITION* screen is active, this is why the **Position (Positn)** is highlighted. In order to switch over to another screen menu simply the softkey of the desired screen menu must be pressed.

The last softkey of the first level of screen menu (beside the **action menu** key ) is the **Page**. With this softkey can the next screen be switched over within the screen menu without activating the menu by pushing the softkey of the active screen menu.

The control memorizes the screen within the screen menu, and when returning to the screen menu it offers the same screen. For example: On the **POSITION** screen menu the *MACHINE POSITION* is displayed by means of **Page** than after selecting the **OPERATOR'S PANEL** screen menu the **POSITION** screen menu is returned, in this case the *MACHINE POSITION* screen appears (the name of the screen can always be seen in the third line).

Should the control contain five softkeys (9" monitor), it can only display five menu fields at a time. In this case the first level of the **screen menu** is as follows:

<b>Position</b>	Check	Program	Offsets	Page
1	2	3	4	5

Note, that the fifth softkey is the **Page!**

The part containing the further screen menus can be displayed by pressing **screen menu** key



Graphics	Setting	Service		Page
1	2	3	4	5

Here the caption of neither screen menu is highlighted, for the **POSITION** screen menu is active, but presently it is not shown. As the last screen menu is the *SERVICE*, by pressing **screen menu** key  again the previous part of the screen menu is returned. If there were

further items after Service screen menu, those would be shown by pressing the **screen menu** key , until the first part of screen menu is returned.

The number seen in the bottom right corner of menu field indicates the softkey number of the appropriate menu field and not the line number of the menu within the screen menu (for more see parameter *SFNUMB* ).

By pressing the softkey of the active screen menu, its menu appears. On the basis of the previous example the following menu appears by pressing the **Position** softkey:

Absolute	Relative	Machine	End	Overall
1	2	3	4	5

The Position menu consists of five items, therefore starting with the sixth menu field the forthcoming ones stay blank (for those have no meanings at all).

Suppose, that the second - and last - level of the **screen menu** is in effect. Here by pressing the softkeys the caption of the appropriate menu field becomes highlighted and the selected screen appears immediately. On the second level there is no **Page** softkey, because there the desired screen can instantly be selected. If there is not enough room for the screens forming a screen menu in the menu bar, the subsequent parts can be brought in by pressing the **screen menu** key



. If the last menu item of the screen menu is already in the menu bar, then by pressing

**screen menu** key  the first level of the screen menu is returned.

The following menu items (screens) can be selected from the screen menus:

**Position**

Absolute	Relative	Machine	End	Overall	Cartesia				
1	2	3	4	5	n 6	7	8	9	0

**Check**

Text	Function	Last	Active	Oprtr's	Message				
1	2	3	4	panel 5	6	7	8	9	0

**Program**

Director	View	Edit	Block	FEW					
y 1	2	3	input 4	5	6	7	8	9	0

**Offsets**

Work	Tool	W. offs.	T. leng.	Rel. pos					
offsets 1	offsets 2	measur 3	measur 4	offsets 5	6	7	8	9	0

**Graphics**



Graphic	Draw								
param 1	2	3	4	5	6	7	8	9	0

**Setting**

#1- #33	1	#100- #199	2	#500- #599	3	Timer / counter	4	Tool pot	5	PLC ta- ble	6	User's params	7	Security	8		9		0
------------	---	---------------	---	---------------	---	--------------------	---	----------	---	----------------	---	------------------	---	----------	---	--	---	--	---

**Service**

Param	1	PLC	2	Test I/O	3	Logic anal	4	Test mes	5	Scope	6	Errors	7	Version	8		9		0
-------	---	-----	---	-------------	---	---------------	---	-------------	---	-------	---	--------	---	---------	---	--	---	--	---

Summary: The screen menus are in two levels. The first level has eight screen menus. On the first level the screens can be switched over within the active menu field by means of **Page** softkey. If all menu items do not have enough room on the screen, the **screen menu** key  turns a page. If the last menu item is shown in the menu bar, then by pressing **screen menu** key  again, the first part of the first level is returned.

**2.2 Action Menu**



If some kind of action e.g., data input is to be done on different screens, the action menu belonging to the screen can be switched over in the menu bar by pressing **action menu** key



. As could the screen menu, the action menu can also have maximum two levels, but in some cases there are menu items already on the first level, that result in direct action.

The default background color of the action menu is orange. The active state of menu field may also be indicated apart from the highlighted (white) or dark (black) colors of the caption by the depressed state of menu field. If an action cannot be activated in the given control state, the background color of menu field changes to the color of the screen menu and the menu field serves no longer as a start button and is only surrounded by a frame.

If all action menu items belonging to the given screen do not have enough room in the menu bar, then - as in case of screen menu - it is possible to turn the page within the menu by means

of **action menu** key . If the last menu is already on screen, then by pressing **action menu** key  the first part of the first level of the action menu is returned.

The action menu is determined by the active screen.





**2.3 Data Input**







On the different screens data input can be initiated. Data input must be started by pressing

**action menu** key  The data input line is on the bottom of screen, above the softkeys is the data input line, where the control gathers the entered data.

Numbers are entered according to the following rules:

- The number entered gives value to the address defined in the data input line.
- It is not mandatory to enter the left-hand (insignificant) zeros.

- The digit entered is interpreted as an integer or as a decimal digit before or after the decimal point has been pressed, respectively.
- It is not necessary to enter the right-hand insignificant zeros behind the decimal point or the decimal point (in the case of an integer value).
- The data input can be started with decimal point when the integer part of a number is zero.
- Key  and incremental operator **I** (provided they are permissible for the given address character) may be hit several times during the input of the number, any time before the use of arrow keys terminating the numeric input. The default is a positive absolute value. The incremental data input and the sign will be indicated in the first and second positions of the location in front of the number, respectively.
- The control system displays **DATA** error message during data input whenever a formal error is committed in the number to be specified for the given address (exceeding the number of integer or decimal digits, illegal use of the incremental operator or one of keys   
or .
- A numeric input in progress can be cleared any time by key <DEL>  before termination. In this case the condition preceding the commencement of numeric input is restored.

The effects of keys  and  terminating a numeric input differ from each other in that forward or backward stepping in the address chain will be performed upon depression of   
or , respectively. Keys  and  can be used for stepping the address chain (in the absence of a numeric input) as well as for the termination of a numeric input.

### **3 General Displaying Areas and Actions Executed on Them**

Each general displaying area is accessible any time, independent of the current operation mode or other states of control.

However actions belonging to the given display cannot be executed any time, the execution can depend on the mode or other states of control. For example editing of parameters can only be done in EDIT mode, although the list of parameters can be seen any time, in AUTOMATIC mode even during machining . If execution of an action is impossible in the given control mode, it is indicated by two arrows pointing at each other →← (conflicting state) in the status field of the seventh message line.

It is quite another matter, that the action may be able to be executed in any control mode, still the action will not be effective immediately. For example the tool offset value can be changed any time, even during milling, yet the machining must be interrupted (create INTD state) and restarted for the control to register the new offset value.

### 3.1 POSITION Screens

There can be five types of POSITION screens. The first four screens displays the selected position with big-size characters, meanwhile on the fifth screen all position displays as well as in case of six or fewer axes the feed and revolution values are also displayed with normal characters. In case of an oriented spindle when the loop is closed (state M19) the screen shows the angle position of the spindle instead of the revolution. If the spindle can be programmed as axis C, the line starts with C in place of S. In the line of feed display the current coordinate system number can also be read.

JOG		500.000		03/02/28 11:20					
<b>ABSOLUTE POSITION</b>				<b>00000</b>					
X	39.225								
Z-	13.952								
ABSOLUTE 1	RELATIVE 2	MACHINE 3	END 4	OVERALL 5	CARTESIAN 6	7	8	9	0

#### ABSOLUTE POSITION Screen (Absolt):

In the selected coordinate system in respect of the appropriate offsets and compensations.

#### RELATIVE POSITION Screen (Relatv):

After reference point has been returned it corresponds to *absolute position*. It can be overwritten or zeroed in an optional state.

#### MACHINE POSITION Screen (Mach):

Position measured

in the G53 coordinate system in respect of length offsets.

JOG		500.000		03/02/28 11:23					
<b>OVERALL POSITION</b>				<b>00000</b>					
<b>ABSOLUTE</b>		<b>DIST. TO GO</b>		<b>END POS.</b>					
X	39.225	X	0.	X	39.225				
Z-	13.952	Z	0.	Z-	13.952				
<b>MACHINE</b>		<b>RELATIVE</b>		<b>CARTESIAN</b>					
X	39.225	X	39.225	X	39.225				
Z-	13.952	Z-	13.952	Z-	13.952				
<b>COMMAND</b>		<b>ACTUAL</b>							
F	0.0000	0.0000	100%	100%					
S	0	0	100%	G54					
BLOCK INPUT 1	MODES 2	AXES 3	INCR 4	% 5	CONDITIONS 6	MACHINE 7	CLEAR REL.PB 8	9	0

#### END POSITION Screen:

End position of the block in the current coordinate system in respect of length offsets.

#### OVERALL POSITION Screen

**(Overll):** Beside the previous four displays the **distance to go** also gets to be displayed. It shows how much is left of the current movement. By this display (in case of six or fewer axes) the programmed and current feed and revolution can also be seen.

**CARTESIAN POSITION Screen:** In the state of polar coordinate interpolation on (G12.1) it indicates the tool position in the programmed Cartesian coordinate system. In the state of polar coordinate interpolation off (G13.1) positions indicated here are the same as on the screen ABSOLUTE.

The first three screens also have a setting function; The position display selected the last time will be beside *distance to go* and *end position* by general displaying areas (except for offsets), where the position display can be seen on the top of general displaying area.

**Actions of POSITION Screens**

Actions of POSITION screens correspond to that of the **OPERATOR'S PANEL** screen (see the chapter 3.2.4).

### 3.2 CHECK Screens

This screen serves for displaying running programs and their states.

#### 3.2.1 PROGRAM TEXT Screen, Listing of Running Program

AUTM		SIRT		MOV						
						03/02/28 11:28				
PROGRAM TEXT						01000				
ABSOLUTE		DIST. TO GO		END POS.						
X	280.000	X	0.	X	280.000					
Z	0.357	Z	239.643	Z	240.000					
F	0.0000		0.0000	100%	100%					
S	0		0	100%	G54					
> G94 G0 X280 > Z240 > T101 > G52 X4 ZZ > G42 G0 X210 Z210 > M3 M8 S500 > X200 > G1 Z20 F300 > G0 X210 > Z210 > G0 X200 > #100=#5001										
TEXT	FUNCTI	LAST	ACTIVE	OPRTR	MESSAG					
1	ON 2	3	4	S PAN 5	E 6	7	8	9	0	

In the lower part of general displaying area the list of the running program can be seen. One block on the list is highlighted; This is the block under execution. In the middle part of general displaying areas of feed and revolution can be seen (provided the number of displayed axes is not more than six). The position display is in the upper part of general displaying area. In the first column the current tool position in agreement with the selected POSITION screen (see the chapter 3.1), in the middle

column the *distance to go* position, while in the right one the *end* position can be seen.

#### 3.2.2 FUNCTION Screen, Subprogram and Macro Levels

AUTM		SIRT		MOV						
						03/02/28 11:29				
FUNCTION						01000				
ABSOLUTE		DIST. TO GO		SUBPROGRAM						
X	200.000	X	0.							
Z	169.672	Z-	149.672							
COMMAND		ACTUAL								
F	300.0000		300.0000	100%	100%					
S	500		0	100%	G54					
M03 M11 T0101 M08										
TEXT	FUNCTI	LAST	ACTIVE	OPRTR	MESSAG					
1	ON 2	3	4	S PAN 5	E 6	7	8	9	0	

In the right-side *subprogram* field of general displaying area the active subprogram(s) can be seen. Directly after the number of the subprogram stands the repetition number. The fields on the bottom of general displaying area show information on the revolution state of spindle (M3, M4, M5, M19), of the gear range (M11, M12, M113, M14,...), of the current tool (Tnnnn), of auxiliary functions (A, B and C), as well as of further (in PLC program defined) M codes.

The first column shows the position in agreement with the selected POSITION screen (see the chapter 3.2), while the second one shows the *distance to go* position.



### 3.2.3 LAST and ACTIVE screens. G Codes and Compensations.

On the **LAST** and **ACTIVE** screens the active G codes and compensations under block display (**LAST**) and program execution (**ACTIVE**) can be seen. The **LAST** screen corresponds to the values of #4000..., #4100... macro variables, while the **ACTIVE** screen to that of #4200..., #4300... .

AUTM	STRT	MOV	03/02/28 11:55						
<b>ACTIVE</b>		<b>01000</b>							
<b>ABSOLUTE</b>		<b>DIST. TO GO</b>		<b>END POS.</b>					
X	170.000	X	0.	X	170.000				
Z	172.275	Z-	89.356	Z	82.919				
F	300.0000	300.0000	100%	100%					
S	500	0	100%	G54					
G01									
		G54		G64					
G18(ZX)									
G23									
		G94							
G42									
		G98		T0101					
TEXT	FUNCTI	LAST	ACTIVE	OPRTR	MESSAG				
1	ON 2	3	4	S PAN5	E 6	7	8	9	0

The current tool position is displayed on the upper part of general displaying area. In the first column the position in agreement with the selected **POSITION** screen (see the chapter 3.1), in the middle column the *distance to go* position, while in the right one the *end* position can be seen. If less than seven axes are to be displayed information on feed and spindle revolution appears in the middle part of general displaying area.

In the lower part of general displaying area starting from the left, downwards the G codes and the tool number with the compensation number can be seen.

Of the G codes only those, different from default setting are displayed.

### Actions of screens PROGRAM TEXT, FUNCTION, LAST and ACTIVE.



**Block Input action menu:** Pushing action menu button  and selecting action menu



**Block Input**, it is possible to input and execute a program block or to modify an old one. Block Input and execution is only available in modes jog (**JOG**), incremental jog (**INCR**) or handle (**HNDL**).

The block demanded can be edited by the alphanumerical keys. In the line has been

edited cursor can be moved by the keys  or  if something is to be over-

written or deleted. For insertion use key  **INS**. By pushing it **INSERT** and

**OVERWRITE** state can be toggled. Use buttons  **DEL**, or  (**Backspace**) for deletion.

Block input can be terminated by keys  (**Enter**),  or . Then in status field 2 the title (**SBEX**) (single block execution) appears. Using **START** button the single block is executed. With **RESET** key single block execution can be cancelled (even before pushing **START**) and the block can be edited again. Single block in buffer is saved and can be recalled until turning the control off.

Action **I** can be used for input of incremental operator. Action **Block Delete** clears the whole block in buffer.

### 3.2.4 OPERATOR'S PANEL Screen



The general display area of OPERATOR'S PANEL shows a view on the state of the most essential machine control items. The controllability of different item groups from softkeys is permitted by the PLC program. The illustration shows the general displaying area of the control panel.

In the topmost button group the state of operation mode switches can be seen. Below it the state of axis selecting switch is shown. This is followed by the increment selecting switch, than in

the third line the percent switches are displayed.

The button group in the middle reflects the state of condition switches and the one below that of PLC switches.

#### Actions of OPERATOR'S PANEL Screen

The following actions can be activated on Operator's Panel screen by pressing **action menu**

key  :

Modes	Axes	Incr	%	Conditio	Mach	Clear			
1	2	3	4	ns 5	6	rel.pnt. 7	8	9	0

The first six keys are menu keys, i.e. by pressing the appropriate softkey the action keys belonging to the given menu become visible. On the menu field of action keys, if the appropriate softkey is pressed and the control accepts it the key stays depressed. The seventh CLEAR RELPNT is an action key, i.e. its pressing results in an immediate effect.

The controllability of each action menu from softkeys is permitted or prohibited by the PLC program. If an action cannot be controlled from softkeys, it can be accessed from an external control device. Instruction regarding this can be found in the enclosed manual of the machine.

### Operation Modes Actions (Modes)

The following modes can be selected:

Edit	Auto	Mdi	Jog	Incr	Handle	Ref			
1	2	3	4	5	6	7	8	9	0

### Axes Actions

In the menu bar all axes of the machine tool are listed. Here the axis, with which an action must be done, can be selected. This action is necessary for example if an axis is to be moved by means of a manual handle. The axis to be moved must be selected by the use of the appropriate softkey. In this case a highlighted frame surrounds the letter indicating the selected one in the **Axis** line of general displaying area.

X	Y	Z	B						
1	2	3	4	5	6	7	8	9	0

### Increment Actions (Incr)

In the menu bar the eligible increment sizes are listed. If one is selected, it is surrounded by a highlighted frame. The selected increment has function in the **Incremental feed (INCR)** and **Manual handle feed (HNDL)** modes. The values seen in the menu bar are in increments.

1	10	100	1000						
1	2	3	4	5	6	7	8	9	0

### % Actions

The rapid traverse, spindle and feedrate switches can be modified by pressing softkeys.

R-	R+	S-	S+	F-	F+				
1	2	3	4	5	6	7	8	9	0

The current position of switches can be seen in the middle of general displaying area at addresses G, S and F.

### Conditions Actions

The following states can be switched on or off:

Single	Cond.	Cond.	Block	Block	Dry run	Machin	Test		
block	block	stop	return	restart		e lock			
1	2	3	4	5	6	7	8	9	0

### Machine Actions (Mach)

Maximum eight optionally used softkeys. Their captions are determined by the PLC program, about their operation and usage instructions can be read in the enclosed manual of the machine. Provided the :197 module of PLC program does not contain the caption of keys, the **PLC1**, **PLC2** ... **PLC8** is set automatically.

### **Clear Relative Position Actions (Clear Relpnt)**

The relative coordinate displays can be zeroed by means of action keys. Relative position setting by axes is discussed in the chapter 3.4.5.

### **3.2.5 MESSAGES Screen**

In this general displaying area the momentary messages in waiting state can be seen. As in the 2<sup>nd</sup> field of the status bar only the active message (waiting for intervention) can be read, this general displaying area shows, whether there are any other messages at the moment apart from those seen in status bar, that due to this cannot be displayed.

### 3.3 PROGRAM Screens

Screens of actions executed on part programs.

#### 3.3.1 DIRECTORY Screen

In the top line of general displaying area the number of programs in memory and the free memory in bytes can be seen.

The programs in memory are listed in the middle part. The control records the programs

NUMBER	NAME	BYTES
01000	Main program	311
01001	Subprogram 1	99
01002	Subprogram 2	91
01003	Subprogram 3	70

according to their code; These numbers can be read in the first column. In the middle column may be the name of program (it is not obligatory to name the program, therefore this column may be here and there blank). The last column contains the program length in bytes. If above or below the last column arrows can be seen, this means, that the entire list does not have enough room in the general displaying area and in the direction of the arrow further programs can be found.

On the list a highlighting bar can be moved by means of arrow

keys. This highlighting bar enables to select the program with which an action needs to be done.

#### Actions of DIRECTORY Screen

The following actions and action menus can be activated to the DIRECTORY screen by means of pressing **action menu** key :

New	Search	Delete	Load	Save	Run	Restore	Sort	Protect	
1	2	3	4	5	6	7	8	9	0

AUTM											
DIRECTORY						03/02/28 12:01					
5 PROGRAMS						01000					
						52992 BYTES FREE					
NUMBER	NAME		BYTES								
01000	Main program		311								
01001	Subprogram 1		99								
01002	Subprogram 2		91								
01003	Subprogram 3		70								
00225			6								
Name: NEW PROGRAM_											
NEW	SEARCH	DELETE	LOAD	SAVE	RUN	RESTOR	SORT	PROTEC			
1	2	3	4	5	6	E 7	8	T 9	0		

**New Action:** When pressing the softkey a window opens in the bottom left part of general displaying area, where the program number can be typed in. The input can be terminated by any arrow key. In this case a new program occurs with the number entered, or an error message is displayed, if there is already a program with the same number or if there is no room in the memory.

If the program number input is terminated by the arrow pointing to the right, the name of the program can also be specified here. When typing a name, switch-over between normal and capital letters can be done by means of page keys, while by pressing **INS** , and ', :, " or ! accented or special characters can be entered.

**Search Action:** After pressing the softkey a program number can be entered into the window in the bottom left corner of general displaying area. By terminating number input by means of any arrow key the highlighting bar goes to the registered program, or an error message is displayed, if there is no program with the entered number in the memory.

**Delete Action Menu:** By pressing the key another three actions occur: **Ramdisc**, **Exec**, **Cancel**. By means of **Ramdisc** key it can be decided, whether the programs in memory or the programs of **NCT90RD** unit connected to the control are to be deleted. As the effect of **Exec** the action is executed, while with the help of **Cancel** the action can be canceled; in this case the first level of the action menu is displayed.

**Load Action Menu:** By pressing the key the following actions appear in the menu bar: **Serial**, **Ramdisc**, **Prom**, **Exec** and **Cancel**. By means of the first three switches it can be set, from where is the program to be loaded in the control memory. As the effect of **Exec** the loading process starts, while with the help of **Cancel** the first level of action menu can be displayed.

**Save Action Menu:** By pressing the key the following actions appear: **Serial**, **Ramdisc**, **Exec** and **Cancel**. By means of the first two switches it can be set, where to is/are the selected program(s) to be saved. The saving process starts as the **Exec** key is affected, while the **Cancel** key displays the first level of action menu, this way canceling the action.

**Run Action Menu:** By pressing the key the following softkeys appear in the menu bar: **Auto**, **Manual data input**, **DNC** and **DNC NCT**, **Table**. By means of the first softkey (**Auto**) the program can be selected for automatic operation. The key is ineffective, if the control is in automatic mode and state **INTD**, **STRT** or **STOP** is in effect. With the help of the second action key the program of manual data input mode can be selected. The last two action keys determine the **DNC** mode. The **DNC** key switches over the control to simple DNC mode without protocol, while with the help of **DNC NCT** key

DNC contact working on the basis of DNC protocol can be implemented. The **Chart** action is only effective in Edit mode. By pressing it, provided program No. T (tool pot table) or P (PLC table) is highlighted, the file containing the selected chart is loaded to the appropriate chart. See the chapter 3.6.5 “**TOOL POT TABLE**” and the chapter 3.6.6 “**PLC TABLE**”. Using key **DNC FEW** programs can be executed from PC optionally integrated into the control.

**Restore Action Menu:** When pressing the softkey the deleted files, that are still in the control memory and can be totally undeleted are displayed in the general displaying area. By moving the highlighting bar to the appropriate program the selected file can be re-applied with the help of **Exec** action.

**Sort Action Menu:** The sorting of programs found in directory in the - by softkeys - selected aspect can be implemented. Within the sort action menu the following softkeys exist: **Incrsg** (increasing), **Decrsg** (decreasing). the sorting direction, as well as **Selected** (selected), **Type**, **Size (byte)** and **Number** for selecting the sorting aspect. As the effect of **Exec** the action is executed.

**Protected Action:** As the effect of the action the *protected* attribute of the selected file(s) can be switched on or off.

### 3.3.2 VIEW Screen



In the general displaying area the list of the program selected on DIRECTORY screen, can be seen. The number and name of the program can always be seen in the topmost line. A highlighting bar can be moved on the program, which highlights one block at a time. The highlighting bar can be moved by arrow and page keys. The highlighting bar has function by **Block search** actions. There the bar is also a means of selecting the block from which the machining is to be continued.

#### Actions of VIEW Screen

On the VIEW screen the following actions and action menus are at disposal, after the **action menu** key  is pressed:

First	Last	Check	Block						
1	2	3	search 4	5	6	7	8	9	0

**First Action:** When pressing the key the highlighting bar goes to the first block of the program.

**Last Action:** When pressing the key the highlighting bar goes to the last block of the program.

**Check Action:** When pressing the key control brings the highlighting bar to the last block of the program, meanwhile it reads the entire program and examines its check sum. This way it checks if the program in memory is damaged (the program can be damaged for example due to storage or operation in too low temperature).

**Block Search Action Menu:** When pressing the key the following actions occur: **First**, **Last**, **Exec**, **Go**, **Interrupted** and **Cancel**. For description of the search actions see the chapter 13.6 “Automatic Operation Start after Block Search” on the page 117.

### 3.3.3 EDIT Screen

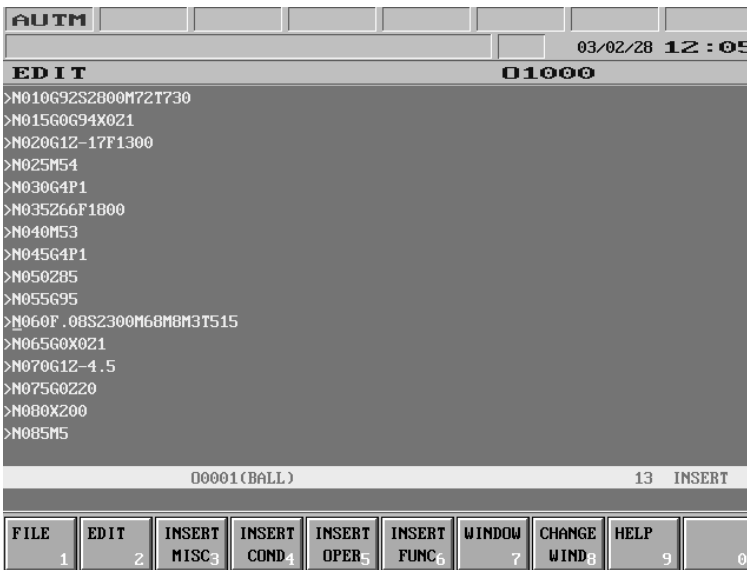

In the general displaying area the list of an editable program can be seen. The number and name of a program can always be read in the first line of the area.

It is possible to write or modify the program by pressing **action**

**menu** key . Modification

of *protected* programs is not possible. If **EDIT** mode is active and no program execution is interrupted (**INTD**), the selected main program is displayed on Directory screen, while if execution is interrupted it is the

program, in which the line under execution can be found. In case the control is not in **EDIT** mode, or the second window is opened, the program selected on Directory general displaying area is displayed. If execution is not in **INTD** state modification of running program is not permitted.

#### Actions of EDIT Screen

For description of EDIT screen see the chapter 4.4 “Actions of EDIT Screen” on the page 62.



### 3.3.4 BLOCK INPUT Screen



In the upper part of general displaying area the current position can be seen. It is possible to enter single block as well as to re-execute or to modify a block entered earlier on by pressing

**action menu** key . A single block is to be entered similarly to that of a program block, however in the address chain of the single block the address letters, of which the entering would be here senseless are automatically not specified. Entering single block is only possible in jog

(**JOG**), incremental jog (**INCR**), or manual handle feed (**HNDL**) mode, otherwise by pressing **action menu** key  the address chain does not even show up.

#### Actions of BLOCK INPUT Screen

After pressing **action menu** key  the following actions are available to the BLOCK INPUT screen:

I	Block delete	Help							
1	2	3	4	5	6	7	8	9	0

**I Action:** The key makes it possible to switch the I (incremental) operator on and off on the current address letter. When executing a letter I shows up directly after the coordinate address.

**Block Delete Action:** The key serves for deleting a block in the single block buffer (that has been written in earlier on).

**Help:** if the cursor stands on a G function and softkey Help is pressed, than the illustration of the G code execution is drawn on screen.

The single block is to be terminated by key . In this case caption **SBEX** occurs in the 2<sup>nd</sup>

field of status bar. By affecting **START**  button the single block is executed. The

execution of a single block can be interrupted by means of **RESET**  key (even before pressing the **START** button), this way the previous block can be re-edited. The block in the buffer is kept until the power is turned off.

### 3.4 OFFSETS Screens

Screens of actions executed on zero point and offset registers.

#### 3.4.1 WORK OFFSETS Screen

HNDL		10		03/02/28 12:09	
<b>WORK OFFSETS</b>				<b>01000</b>	
WORK1	G54	X-	123.450	Z-	267.891
WORK2	G55	X	0.000	Z	0.000
WORK3	G56	X	0.000	Z	0.000
WORK4	G57	X	0.000	Z	0.000
WORK5	G58	X	0.000	Z	0.000
WORK6	G59	X	0.000	Z	0.000
WORK	SHIFT	X	0.000	Z	0.000
G52		X	0.000	Z	0.000
WORK OFFSE1	TOOL OFFSE2	W.OFFS . MEA3	T LENG MEAS1	REL.PO S OFF5	6 7 8 9 0

In the general displaying area are offset values of G54, ..., G58, common zero point offsets, as well as of offsets programmed by means of commands G52 and G92. The coordinate values belonging to one zero point form a group. Along the groups the highlighting bar can be moved forward (in the direction of increasing coordinate system numbers) with the help of key



and backward with key



. Within the highlighting

bar indicating the coordinate system the inverse bar on axis addresses can be moved with keys



and



. This bar makes it possible to select the wished axis within the coordinate system.

#### Actions of WORK OFFSETS Screen

HNDL		10		03/02/28 12:11	
<b>WORK OFFSETS</b>				<b>01000</b>	
WORK1	G54	X-	123.450	Z-	267.891
WORK2	G55	X	0.000	Z	0.000
WORK3	G56	X	0.000	Z	0.000
WORK4	G57	X	0.000	Z	0.000
WORK5	G58	X	0.000	Z	0.000
WORK6	G59	X	0.000	Z	0.000
WORK	SHIFT	X	0.000	Z	0.000
G52		X	0.000	Z	0.000
X	-123.				
CLEAR GROUP1	CLEAR ALL 2	I 3	/2 4	SAVE 5	6 7 8 9 0

Actions executed on WORK OFFSETS screen overwrite offset registers immediately, however this is registered by the program under execution only in case the program has been started from the beginning or the program execution is interrupted (INTD state) and afterwards restarted. So the current coordinate system is overwritten in vain, the modified value will not be registered till the modified coordinate system is not used by the system. It also follows, that hasty overwrite of the coordina-

te system will not cause immediate problem during program execution, its effect may only be perceptible in case of the next running of program, so when overwriting it be extremely cautious. To the WORK OFFSETS screen the following actions and action menus can be

activated by pressing **action menu** key :





Clear group	1	Clear all	2	I	3	/2	4	Save	5	6	7	8	9	0
----------------	---	--------------	---	---	---	----	---	------	---	---	---	---	---	---

**Clear Group Action Menu:** When pressing the key the question **CLEAR G5x?** (G5x according to current coordinate system) appears in the bottom left part of general displaying area, together with **Exec** and **Cancel** actions in menu bar, the meaning of which is the usual.

**Clear All Action Menu:** When pressing the key the question **CLEAR ALL?** Occurs in the bottom left part of general displaying area, together with **Exec** and **Cancel** actions in menu bar, the meaning of which is the usual.

**I Action:** The key enables switching of I (incremental) operator on and off on the current address letter. During the execution letter I appears directly after the coordinate address. The value entered will be added to the original offset value.

**/2 Action:** It halves value written on the current address letter. After execution half of the value in the coordinate address can be seen.

**Save Action:** When pressing the key the program number can be entered into the bottom data input line. In case the input is terminated by any of the keys  or , the program can also be named there. As the effect of keys  and  the offset values are saved in the appropriate macro variable. If in such way saved offset values need to be reset, the program must be selected for automatic execution and executed in automatic operation.

### 3.4.2 TOOL OFFSETS Screen

HNDL		10		03/02/28 12:13	
TOOL OFFSETS		01000			
		GEOMETRY		WEAR	
N01	X	-	126.480	0.000	
	Z		28.420	0.000	
	R		0.800	0.000	
	Q		3		
N02	X		0.000	0.000	
	Z		0.000	0.000	
	R		0.000	0.000	
	Q		0		
N03	X		0.000	0.000	
	Z		0.000	0.000	
	R		0.000	0.000	
	Q		0		
N04	X		0.000	0.000	
	Z		0.000	0.000	
	R		0.000	0.000	
	Q		0		
X -45.3					
CLEAR ALL	1	CLEAR GEOME	2	CLEAR WEAR	3
CLEAR GROUP	4	I	5	/2	6
OFS NO SEAR	7	SAVE	8	9	0

In the general displaying area the values of tool offsets in X, Z (optionally Y) directions as well as the tool nose radius compensation value and the imaginary tool nose number at address Q can be seen. The offset registers with identical number form a group. The real offset value is specified by the signed sum of geometry and wear values. Along the groups the highlighting bar can be moved forward (in the direction of increasing register numbers) with the help of key , while backward

with key . Within the highlighting bar indicating a group an inverse bar can be moved by

keys  and . This bar selects the offset register to be modified.

### Actions of TOOL OFFSETS Screen

Actions executed on TOOL OFFSETS screen overwrite offset registers instantly, however it is registered by the program under execution only if the program has been started from the beginning or the program execution is interrupted (INTD state) and restarted. So the current offset is overwritten in vain, the modified value will not be registered till the modified values are not called by the system. It also follows, that hasty overwrite of offsets during program execution will not cause an immediate problem, its effect may only be perceptible in case of the next running of the program, so when modifying be extremely cautious.

The following actions and action menus can be activated to the TOOL OFFSETS screen by pressing **action menu** key :

Clear all 1	Clear geomtry2	Clear wear 3	Clear group 4	I 5	/2 6	Ofs No search 7	Save 8	9	0
----------------	-------------------	-----------------	------------------	--------	---------	--------------------	-----------	---	---

**Clear All Action Menu:** When pressing the key the question **CLEAR ALL?** can be read in the bottom left part of general displaying area, together with **Exec** and **Cancel** actions in menu bar, the meaning of which is the usual.

**Clear Geometry Action Menu:** When pressing the key the question **CLEAR ALL GEOMETRIES?** can be seen in the bottom left part of general displaying area, together with **Exec** and **Cancel** actions in menu bar, the meaning of which is the usual.





**Clear Wear Action Menu:** When pressing the key the question **CLEAR ALL WEARS?** can be seen in the bottom left part of general displaying area, together with **Exec** and **Cancel** actions in menu bar, the meaning of which is the usual.

**Clear Group Action Menu:** When pressing the key the question **CLEAR THIS GROUP?** can be seen in the bottom left part of general displaying area, together with **Exec** and **Cancel** actions in menu bar, the meaning of which is the usual.

**I Action:** The key enables switching of I (incremental) operator on and off on the current address letter. During the execution letter I appears directly after the coordinate address. The value entered will be added to the original offset.

**/2 Action:** It halves value written on the current address letter. After execution half of the value in the coordinate address can be seen.

**Offset Number Search Action:** When pressing address N occurs in bottom data input line. After the value has been entered and terminated (by any of the arrow keys) it searches for the entered offset group in the memory.

**Save Action:** When pressing the key an O program number can be entered into the bottom data input line. In case the input is terminated by any of the keys  or , the program can also be named there. As the effect of keys  and  the offset values are saved in the appropriate macro variable. If in such way saved offset values need to be reset, the program must be selected for automatic execution and executed in automatic operation.

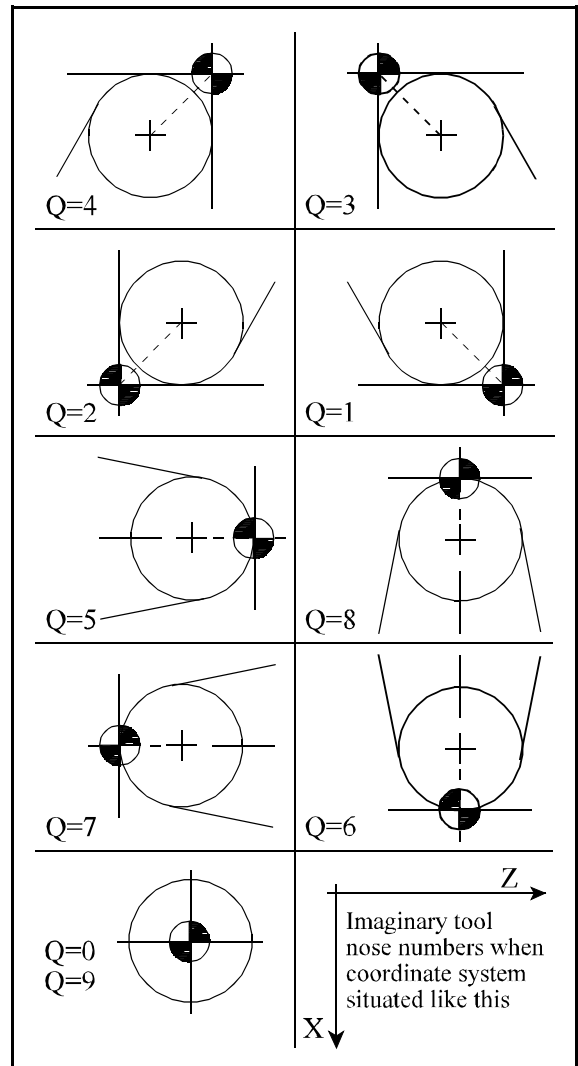
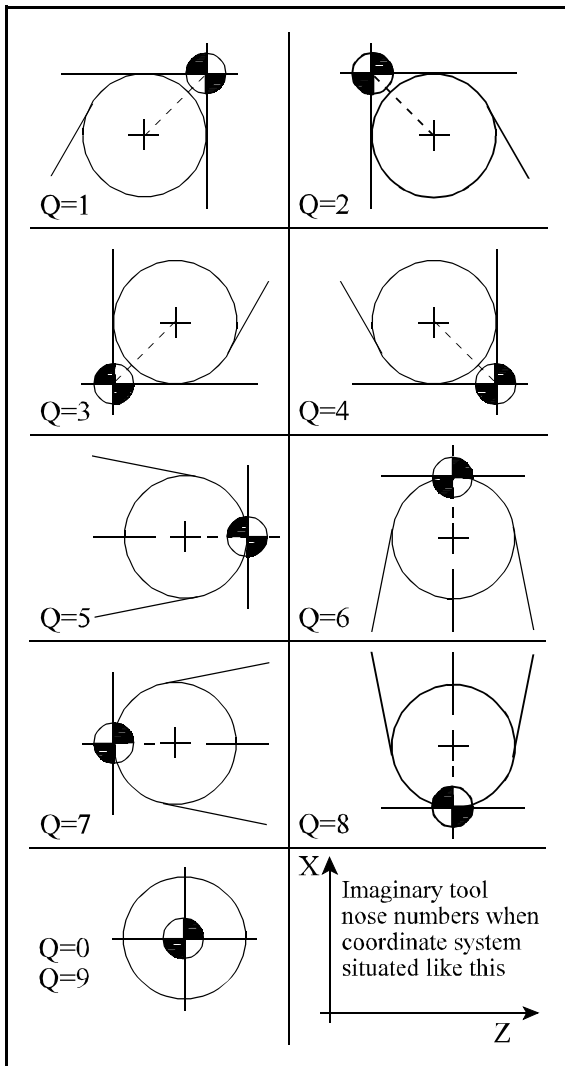

On the figures below the interpretation of the imaginary tool nose number (Q) can be seen.



3.4.3 WORK OFFSET MEASURE Screen

HNDL		10		03/02/28 12:15	
WORK OFFSET MEASURE				01000	
MACHINE	G54	ABSOLUTE	END POS.		
X	290.480	X	413.930	X	413.930
Z	180.805	Z	448.696	Z	448.696
F	300.0000	300.0000	100%	100%	
S	500	0	100%	G54	
GEOMETRY			WEAR		
N01	X	- 126.480	0.000		
	Z	28.420	0.000		
WORK1 G54					
	X-	123.450	Z-	267.891	
X	123.4				
WORK	OFS. N	/2	BLOCK		
COORD1	0 SEA2	3	INPUT4	5	6
				7	8
				9	0

In the upper part of general displaying area the current tool position can be seen. The first column always shows the machine position, the middle column the position in the selected coordinate system, while the last one the distance to go position. The following information can be seen in the lower part of general displaying area going downwards. In line Nnn the length offset values of the indicated offset group can be seen for each axis. In the next line stands the number of the selected coordinate system, and below its offset registers.

Along the offset registers highlighting bar can be moved by means of keys  and . This highlighting bar enables to select the offset register to be modified.

Actions of WORK OFFSET MEASURE Screen



The following actions and action menus can be activated to the WORK OFFSET MEASURE screen by pressing **action menu** key :

Work coordnt 1	Ofs No search 2	/2 3	Single block 4	5	6	7	8	9	0
----------------	-----------------	------	----------------	---	---	---	---	---	---

**Work Coordinate Action Menu:** When pressing the key the eligible coordinate systems appear in the menu bar: **G54**, **G55**, ... **G59** and **Work shift**. After pressing the appropriate softkey the system returns to first level of action menu.

**Offset No. Search:** When pressing the key letter N appears in spite of the axis address. At this point the number of offset the register can be entered. After entering the offset number the desired length offset register can be seen in general displaying area.

**/2 Action:** It halves value written on the current address letter. During execution half of the value in the coordinate address can be seen in input field.



**Single Block:** By pressing the key a single block can be entered in the bottom, data input line by the use of the alphanumeric keyboard. After closing block edit (key  or ) caption SBEX appears in the 2<sup>nd</sup> field of status bar. The block is executed with START



For detailed description of work offset measure see the chapter 7.2.1 “Work Offset Measure” on the page 76.

### 3.4.4 TOOL LENGTH OFFSET MEASURE Screen

HNDL		10		03/02/28 12:17	
TOOL L. OFFSET MEASURE				01000	
MACHINE		G54 ABSOLUTE		END POS.	
X	290.480	X	287.450	X	413.930
Z	180.805	Z	477.116	Z	448.696
F	300.0000	300.0000	100%	100%	
S	500	0	100%	G54	
N02		GEOMETRY		WEAR	
X		X	0.000	X	0.000
Z		Z	0.000	Z	0.000
WORK1 G54		X-		Z-	
		123.450		267.891	
X 120.					
WORK COORD1	OFS. N 0 SEA2	AUTO MEAS 3	BLOCK INPUT4	5	6
				7	8
				9	0

In the upper part of general displaying area the position display can be seen. The following information can be seen in the lower part of general displaying area going downwards. In line Nnn the length offset values of the indicated offset group can be seen for each axis. In the next line stands the number of the selected coordinate system, and below its offset registers. A highlighting bar can be moved along the axis addresses of length offset register by means of keys  and .

### Actions of TOOL LENGTH OFFSET MEASURE Screen



The following actions and action menus can be activated to the TOOL LENGTH OFFSET MEASURE screen by pressing **action menu** key :

Work coordnt 1	Ofs No search 2	Auto meas 3	Single block 4	5	6	7	8	9	0
----------------	-----------------	-------------	----------------	---	---	---	---	---	---

**Work Coordinate System Action Menu (Work cld):** When pressing the key the eligible coordinate systems appear in the menu bar: **G54, G55, ... G59**. After pressing the appropriate softkey the system returns to first level of action menu.

**Offset Number Search:** When pressing the key the letter N appears in spite of the axis address. At this point the number of the offset register can be entered. After entering the offset index the desired length offset register can be seen.

**Automatic Measure:** The function can only be used provided the machine is mounted with a tool length sensor.



**Single Block:** By pressing the key a single block can be entered in the bottom, data input line by the use of the alphanumeric keyboard. After closing block edit (key  or ) caption SBEX appears in the 2<sup>nd</sup> field of status bar. The block is executed with START



For detailed description of work offset measure see the chapter 7.2.2 “**Tool Length Offset Measure inside the Machine**” on the page 79.

**3.4.5 RELATIVE POSITION OFFSETS Screen**



In the general displaying area below the current tool position are the values of relative position offsets. An inverse bar can be moved on axis addresses by means of keys  and .

This bar enables to select the offset register to be modified. Modification of registers does not have the slightest effect on program execution, this display is only for the operator.

**Actions of RELATIVE POSITION OFFSETS Screen**

The following action menu can be activated to the RELATIVE POSITION OFFSETS screen by means of **action menu** key :

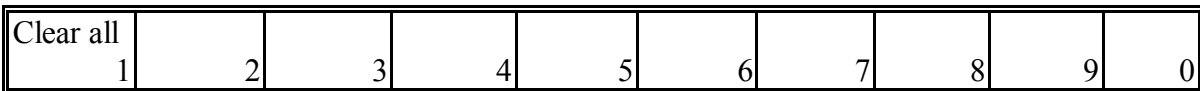

**Clear All Action Menu:** When pressing the key the question **CLEAR ALL OFFSETS?** appear in the bottom left part of general displaying area, together with **Exec** and **Cancel** actions in menu bar, the meaning of which is the usual.





In case the value of the **auto erase** is other than zero, when starting the automatic program execution both the drawing area and the buffer are cleared.

If the value of the **path color** is 0 rapid traverse is drawn with red, feed with green, while thread cutting with yellow color. If the value is not zero, the rapid traverse movements are not drawn.

In case the value of **tool color** is other than 0 the movements are drawn with the appropriate tool color (current T in the course of movement ). The color code is the lower three bytes of the addition of the tool number and the **tool color**.

If the value of **auto change color** is not 0 the drawing starts with the color code specified here, and afterwards every tool change (T change) adds to the color code.

Color	Code
grey	0
blue	1
green	2
gentian	3
red	4
purple	5
yellow	6
white	7

**Actions of GRAPHIC PARAMETERS Screen**

The following action can be activated to the screen by pressing **action menu** button  :

Recalc	Graphic								
1	2	3	4	5	6	7	8	9	0

**Recalculate Action:** When pressing the softkey the position of screen center and the graphic scale are recalculated from the work size according to the selected plane.

**Graphic Action Menu:** After pushing the softkey the following actions appear: **Auto Erase**, **G40**, **G53**, **Dotted**. Using **Auto Erase** the item with the same title in graphic parameters table can be set or reset. Its effect detailed above. The softkey **G40** can only be used in case of running in TEST mode. In its switched-on state the drawing appears on the screen without tool radius compensation. In the pushed in state of button **G53** drawing is done in machine coordinate system instead of the actual work coordinate system, that is if more coordinate systems are used in the same program the tool path can be seen separately. In the pushed in state of button **Dotted** the separate points are not connected together with lines. It is useful when the program consists of small minute lines.

### 3.5.2 DRAW Screen

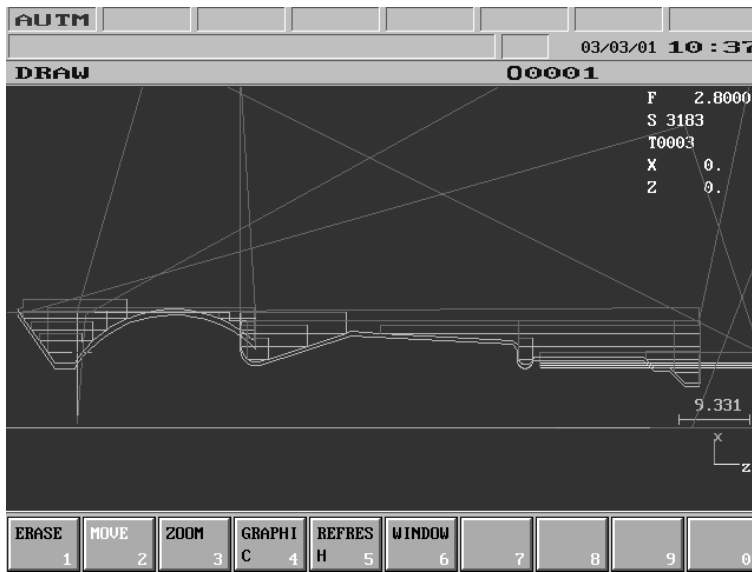

In the drawing area in the middle of screen the current tool center is shown by a cross. The following information can be read in the top right corner of the screen: Current feed, spindle revolution and the number of the current tool. Further on in the column the position display of axes can be seen as selected on the POSITION DISPLAYS screen. (see the chapter 3.1 on the page 22). In the bottom right corner the scale, below it the diagram symbolizing the position of the coordinate system are shown.

In case of automatic execution the cross indicates the current tool position. A dot is also put to the center of the cross. The drawing depends on the speed of movement; as the points are drawn only a few times per second, in case of fast movement the drawn tool path will be not a continuous line, but a dotted one.

*Note:* the size of the cross is defined by parameter 0561 CROSS DOT. The value entered at the parameter specifies the length of the leg of the cross in raster. The value cannot be greater than 7.

#### Actions of DRAW Screen

The following actions and action menus can be activated to the draw screen by pressing **action menu** button  :

Erase	Move	Zoom	Graphic	Refresh	Window				
1	2	3	4	5	6	7	8	9	0

**Erase Action Menu:** When pressing the softkey actions **Image** and **Buffer** appear in the menu bar. As the effect of **Image** action the tool path that has been drawn till now is erased from the screen. **Buffer** action erases the drawing not only from the screen but also eliminates the movement data stored in the buffer.

**Move Action Menu:** The softkey is always highlighted. If the drawing is to be moved in the plane of the screen use the appropriate cursor keys. When pressing the softkey **Move** four arrows appear on softkeys for each movement direction. The arrows indicate the directions in which the drawing can be moved the same way as with the cursor buttons.

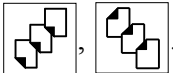
**Zoom Action Menu:** The drawing always can be zoomed by the paging keys: .

When pressing the softkey **Zoom** actions appear for zooming up and down. The actions refer to the page keys in the bottom left corner of the softkeys: **Up (PgUp)**.

**Down (PgDn).** By means of softkeys, as well as the page keys the drawing area can be halved or doubled. As the effect of **Full Scéen** action the centre of the screen automatically adjusted to the middle of the tool path and scaling is set that the tool path covers the whole screen.

**Graphic Action Menu:** After pushing the softkey the following actions appear: **Auto Erase**, **G40**, **G53**, **Dotted**. Using **Auto Erase** the item with the same title in graphic parameters table can be set or reset. Its effect detailed above. The softkey **G40** can only be used in case of running in TEST mode. In its switched-on state the drawing appears on the screen without tool radius compensation. In the pushed in state of button **G53** drawing is done in machine coordinate system instead of the actual work coordinate system, that is if more coordinate systems are used in the same program the tool path can be seen separately. In the pushed in state of button **Dotted** the separate points are not connected together with lines. It is useful when the program consists of small minute lines.

**Refresh action:** The operation clears the screen and draws the tool path again.





**Window Action menu:** After using this key a frame appears on the screen. This frame can be shrunk onto a detail of tool path with function keys appearing on soft keys or cursor and paging keys the way as they are used in Move and Zoom operations. After paging out of this action group the detail assigned by the frame is drawn onto the screen.

### 3.6 SETTING Screens

The following screens can be found in this menu; LOCAL MACRO VARIABLES #1–#33, COMMON MACRO VARIABLES #100–#199 and #500–#599, TIMER and COUNTER, TOOL POSITION TABLE, PLC TABLE, TOOL WEAR TABLE, USER'S PARAMETERS and SECURITY SETTINGS. Contents of variables, timers, counters and tables are preserved upon power-off.

#### 3.6.1 Screen of LOCAL MACRO VARIABLES #1–#33

level	0	1	2	3	4
#1	987.123				
#2	-28.432				
#3	6.8_				
#4					
#5					
#6					
#7					
#8					
#9					
#10					
#11					
#12					
#13					
#14					
#15					

In the general displaying area the local macro variables and their values can be seen. In the five columns the main program and variables of the four possible macro levels are listed. A highlighting bar can be moved along the variables by means of arrow keys  and , while with the help of arrows  and  the columns can be switched over.

Only those variables can be edited, of which the macro level

is already open. At first only level 0 can be edited, but in case a macro call occurred during program execution, this enables the editing of a further level. Till a macro level is not open, editing is unnecessary, for values are given to the variables suitable for the address chain in time of macro call, while the others are vacated.

#### Actions of LOCAL MACRO VARIABLES #1–#33 Screen

No action menu can be activated to this screen, by pressing **action menu** key  a blank action menu is displayed.

It is possible to give value directly to the macro variable by entering a number.

If a vacant value is to be specified, #0 must be entered.

Values can be specified indirectly to the macro variables. This means, that in spite of giving a value, the variable containing the value must be entered. This way only variables #1–#33, #100–#199 and #500–#599 can be specified. The local variables represent the values of the current level.

3.6.2 Screen of COMMON MACRO VARIABLES #100-#199



In the general displaying area common macro variables #100-#199 and their values can be seen. Variables #120-#199 are vacated upon power-off and when resetting automatic mode (RESET) Variables #100-#119 are also vacated in case of value 1 of parameter *CLCV*, otherwise their values are preserved. A highlighting bar can be moved along the macro variables by means of arrow keys up and down. This highlighting bar shows the variables to be edited. A new value can be given to the

variables in the bottom line. By terminating data input the new value is written in the variable. Values can also be given to macro variables indirectly; By entering the code of another macro variable (e.g.: #540) it registers the value of that variable. By entering #0 the macro variable is vacated.

Actions of COMMON MACRO VARIABLES #100-#199 Screen

The following actions and action menus can be activated to the screen of COMMON MACRO VARIABLES #100-#199 by pressing **action menu** key  :

Vacant	Zero	Exp								
all 1	all 2	3	4	5	6	7	8	9	0	

**Vacant All Action Menu:** When pressing the key the question **CLEAR VACANT ALL?** can be seen in the bottom left part of general displaying area, together with **Exec** and **Cancel** actions in the menu bar, the meaning of which is the usual. With **Exec** in effect all macro variables are vacated (#0).

**Zero All Action Menu:** When pressing the key the question **ZERO ALL?** can be seen in the bottom left part of general displaying area, together with **Exec** and **Cancel** actions in the menu bar, the meaning of which is the usual. With **Exec** in effect all macro variables are zeroed (0).

**Exp Action:** When pressing the key the exponent of the variable can be entered.

### 3.6.3 Screen of COMMON MACRO VARIABLES #500–#599



In the general displaying area common macro variables #500–#599 and their values can be seen. These variables are not vacated upon power-off or when restoring automatic mode (RESET), on the other hand by switching to parameters, when saving parameters they are saved to the external device, and when loading parameters the original values are overwritten.

A highlighting bar can be moved along the macro variables by means of arrow keys up and down. This highlighting bar

shows the variables to be edited. A new value can be given to the variable in the bottom line of general displaying area. By terminating data input the new value is written in the variable. Values can also be given to macro variables indirectly; By entering the code of another macro variable (e.g.: #124) it registers the value of that variable. By entering #0 the macro variable is vacated.

#### Actions of COMMON MACRO VARIABLES #500–#599 Screen

The following actions and action menus can be activated to the screen of COMMON MACRO VARIABLES #500–#599 by pressing **action menu** key  :

Vacant	Zero	Exp																	
all	1	all	2		3		4		5		6		7		8		9		0

**Vacant All Action Menu:** When pressing the key the question **CLEAR VACANT ALL?** can be seen in the bottom left part of general displaying area, together with **Exec** and **Cancel** actions in the menu bars, the meaning of which is the usual. With **Exec** in effect all macro variables are vacated (#0).

**Zero All Action Menu:** When pressing the key the question **ZERO ALL?** can be seen in the bottom left part of general displaying area, together with **Exec** and **Cancel** actions in the menu bar, the meaning of which is the usual. With **Exec** in effect all macro variables are zeroed (0).

**Exp Action:** When pressing the key the exponent of the variable can be entered.

### 3.6.4 TIMER AND COUNTER Screen



In the general displaying area the different timers and counters can be seen. The highlighting bar can be moved to the timer or counter to be modified by means of arrow keys. Apart from the operating time the values are free to overwrite.

#### Actions of TIMER AND COUNTER Screen

No action can be activated to this screen, a blank action menu is displayed by pressing **action**

**menu** key , however the

values of timers and counters can be overwritten only in this state.

### 3.6.5 TOOL POT TABLE Screen

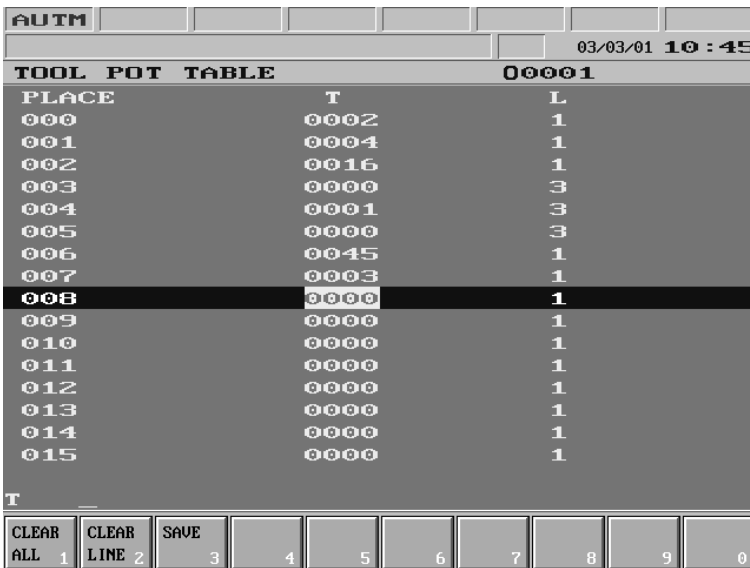

In the general displaying area the tool pot table can be seen. The values of the table are preserved upon power-off.

In case not a local coded tool handle, but a random access magazine handle is to be used, a tool pot table is needed, in which the pot number of the magazine and number of the tool found in it can be selected.

#### Note

**Local coded tool handle means,** that reference to the tool is made at address T by the pot number of the magazine, in

which the desired tool can be found.

If **tool reference is not local coded**, a table is needed, which shows, which tool number can be found in which pot of the magazine.

**Random access magazine handle means,** that the position of tools in the magazine is not fixed. The returning tool (taken from the spindle) is not taken back into the position it was taken out, but into the nearest vacant position in magazine, in the simplest case in place of the selected (new) tool.



The length of the tool pot table can be set in parameter MAGAZINE No. 0061. In parameter MAGAZINE the number of tool pots in the magazine is to be entered. Line 0 of table shows the code of the tool in spindle, i.e., the spindle is pot No. 0.

In the first column of the table the number of tool position or pot, in the second column the under address T the number of the tool in pot, while in the third one under address L the width code of the tool can be found.

#### Usage of width code

In case of fix access magazine handle, i.e., the tool taken out is taken back into from where it was taken, the tool width, i.e., how many pots are being occupied is of no interest.

In case of a random access magazine handle position may also have to be ensured for tools, that are more-than-one tool pot wide. Therefore tool positions, in which extra wide tools can be placed, should have to be selected. This is why a width code must be given to each tool in the tool pot table.

This is needed, for in case of a random access magazine handle the returning tool can be taken to the place of the selected one, should the two tools have the same width code. If however the width of the two tools differ, the returning tool cannot be taken back in place of the selected one. In this case the - to the replacement - nearest vacant position, of which the width equals to that of the returning tool must be searched for.

The following width codes can be entered to the table (under address L):

- 1 (normal size),
- 3, 5 or 7.

The tool that has a width of 3 occupies both to the left and to the right 1-1, that of the width of 5 occupies 2-2, while that of the width of 7 reserves 3-3 positions in the magazine. This way special pots can be selected in the magazine, into which the extra wide tools are placed.

In case of extra wide tools to the pot number, into which the tool is taken also the tool number and the tool width code must be entered. As for the 1, 2 or 3 pot numbers before and after it, to the tool number 0, while to the width the appropriate width code is to be entered. If a tool is taken from the magazine to the spindle in line 0 the tool number and the tool width also has to be entered, and the tool number is to be deleted in the line, from which the tool was taken.

However the width code must be preserved in the table, for to show the returning tool, that the pots are reserved for extra wide tools.

For more information on handling the tool pot table turn to the machine tool builder.

#### **Actions of TOOL POT TABLE Screen**





The following actions are activated by pressing **action menu** key  :

Clear all	Clear 1	Clear line 2	Save 3	4	5	6	7	8	9	0
--------------	------------	--------------------	-----------	---	---	---	---	---	---	---

**Clear All Action Menu:** When pressing the key the question **CLEAR ALL?** can be seen in the bottom left part of general displaying area, together with **Exec** and **Cancel** actions in the menu bar, the meaning of which is the usual. With **Exec** in effect the entire table is cleared.

**Clear Line Action Menu:** When pressing the key the question **CLEAR THIS LINE?** can be seen in the bottom left part of general displaying area, together with **Exec** and **Cancel**

actions in the menu bar, the meaning of which is the usual. With **Exec** in effect the selected line is cleared.

**Save Action:** When pressing the key the program number can be entered into the bottom data input line. In case the input is terminated by any of the keys  or , the program can also be named there. As the effect of keys  and  values are saved in the appropriate macro variable. It is registered in the directory not under program number O, but under address T. Restoring values of the table is discussed in the chapter 3.3.1 on the page 30 “**DIRECTORY Screen**” **Run** action menu **Table** action.

### 3.6.6 PLC TABLE Screen

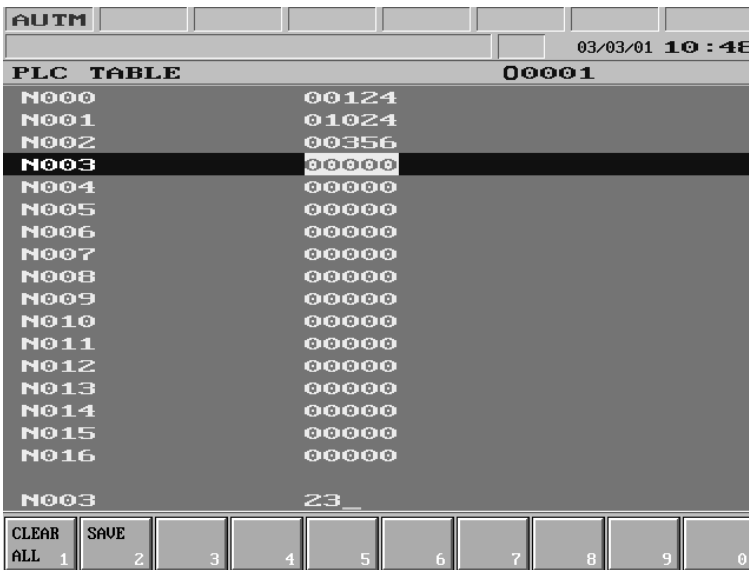

In the general displaying area the PLC table can be seen. Its length is specified in parameter 0062 PLC\_TAB. The table can be optionally used by the machine tool builder.

The contents of the table are preserved upon power-off. The highlighting bar can be moved along the items of table by means of arrow keys .

and .

The items of the table can be overwritten.



For information on usage of the table turn to the machine tool builder.



#### Actions of PLC TABLE Screen

The following actions can be activated by pressing **action menu** key  :

Clear all	1	2	3	4	5	6	7	8	9	0
-----------	---	---	---	---	---	---	---	---	---	---

**Clear All Action Menu:** When pressing the key the question **CLEAR ALL?** can be seen in the bottom left part of general displaying area, together with **Exec** and **Cancel** actions in the menu bar, the meaning of which is the usual. With **Exec** in effect the entire table is cleared..

**Save Action:** When pressing the key the program number can be entered into the bottom data input line. In case the input is terminated by any of the keys  or  the

program can also be named there. As the effect of keys  and  values are saved in the appropriate macro variable. It is registered in the directory not under program number O, but under address T. Restoring values of the table is discussed in the chapter [3.3.1](#) on the page [30](#) “**DIRECTORY Screen**” **Run** action menu **Table** action.

### 3.6.7 USER'S PARAMETERS Screen (User's Params)

EDIT											
										03/03/01 10:50	
USER'S PARAMS										00001	
N0001	IPLCONST										
N0501	DISPLAY										
N1021	COMMON										
N2001	SERIAL										
N2501	FEED/ACC										
N3041	AX.LIMIT										
N7241	REFPAR										
N8061	MEASURE										
N9041	MACRO										
1	2	3	4	5	6	7	8	9	0		

In the general displaying area a restricted part - that can also be set by the user - of the parameters can be seen. The highlighting bar can be moved along the groups seen in general displaying area by means of arrow keys up and down. The selected group can be opened with the help of arrow key right, while with arrow key left the previous level can be displayed. If the highlighting bar stands on a parameter, a new value can be given to the parameter in the bottom line of general displaying

area.

#### Actions of USER'S PARAMETERS Screen

No action menu can be activated to this screen, a blank action menu is displayed by pressing **action menu** key , however the values of parameters can be changed only in this state. Editing of parameters is only permitted in **EDIT** mode.

### 3.6.8 SECURITY PANEL Screen



The control provides wide-range data security service. The picture shows the SECURITY PANEL screen. When the *general security gate is open* the other security gates have no significant role, thus *all actions* listed on the screen *can be executed* even if the symbol **!!** is displayed beside the action.

If however the *general security gate is locked*, i.e., the symbol **!!** is seen beside the caption the *actions, beside* the name of which *lock* symbol **!!** is displayed, *cannot be executed*. If e.g. pa-

rameters are to be edited and this action is locked display **!!** in the 7<sup>th</sup> field of status bar warns us that this action is closed in case action menu button  is pressed on parameters screen.

The *general security gate*, the *DNC channel*, the *parameters*, the *PLC program* and the *service operations* have

**generated code**, or  
**PLC key**,

that means that in case of opening, either as an answer to the digits displayed by the control another number generated from those digits must be given, or the security gate can be opened in the open (enable) state of the key switch mounted on the machine.





The other functions have

**fix code**, or  
**PLC key**,

that means that these functions are opened either with a code given in the below table or in the open (enable) state of the key switch mounted on the machine.

The below table contains the codes of the appropriate functions:

Function	Code	Function	Code
General Security Gate	<b>Generated</b>		
work offsets	<b>15962</b>	open new program	<b>95148</b>
relative position	<b>15962</b>	delete program	<b>95148</b>
tool offsets	<b>15962</b>	edit program	<b>95148</b>
tool pot table	<b>15962</b>	load program	<b>95148</b>
tool life table	<b>15962</b>	save program	<b>95148</b>
timers and counters	<b>7895123</b>	protect program	<b>7895123</b>
PLC table	<b>15962</b>	DNC channel	<b>Generated</b>
#100 macro variables	<b>95148</b>	user's parameters	<b>7895123</b>
#500 macro variables	<b>95148</b>	parameters	<b>Generated</b>
run in auto menu	<b>456852</b>	PLC program	<b>Generated</b>
run in MDI menu	<b>357159</b>	service operations	<b>Generated</b>

Symbol ◀ (cursor) can be moved to the desired data security service within a column by means of buttons  and . If columns are to be switched use buttons , .

If action menu button  is pressed the following actions are offered:

Open	Close								
1	2	3	4	5	6	7	8	9	0

**Open action:** If a locked function is to be opened and **security key** is at disposal move symbol ◀ (cursor) to the function. Turn the data security key to enable position on the machine than press **Open** button.

If **no data security key** is on the machine move symbol ◀ to the function to be enabled than press **Open** button.

In this case, provided the function to be opened has **fix code**, message

Code: \_ \_ \_ \_ \_

appears in the bottom line. After entering the appropriate fix code taken from the above table the data input can be closed with the help of button  and the function is enabled.

If the function has **generated code**, the following message is displayed in the bottom line:

nnnnnnnn code: \_ \_ \_ \_ \_

where nnn is an eight-digit number. Start **Decoder program** on PC and enter the digits seen on control screen. The key code (a 5 digit number) generated by Decoder program must be entered from numeric keyboard to control. After the appropriate code

is entered the data input can be closed by means of button  and the function is enabled.

**Close action:** If a function is to be locked move symbol ◀ (cursor) to the function. Press **Close** button. The selected function is locked independent of the state of the general security gate.

## 4 Editing Part Programs

### 4.1 Structure of Part Program

The part program is made up of blocks. A block consists of words.

#### *Word: Address and Data*

A word is formed by two components: Address and data (e.g., X127.064 or Z#103). The address may comprise one or more characters (X, Z in the example), while the data may be:

- a number that may have integer and decimal number as well (127.064 in the example)
- expression (#103 in the example) that may contain arithmetic or logic operations on variables and numbers.

Some addresses may be given a sign or operator I, independent of the data being number or expression.

Words can be separated by means of space key for the sake of lucidity, although its use is *not obligatory*.

Should a word (a string between two spaces) exceed the length of the given line while typing the editor displays the whole word in a new line.

#### *Block*

A block consists of words. The blocks in memory are separated by character **LF** (Line Feed).

During program editing termination of a block is performed by pressing <ENTER> key 

due to which line feed occurs and at the same time character **LF** is adjusted to the end of the terminated block automatically. As the effect of the key the cursor goes to the beginning of next line.

The start of a new block (character **LF**) is indicated by character > in the first column of screen. In case the block does not have enough room in a line the first column of the following line is left empty and the first character is put in the second column.

Block number can be written at the beginning of blocks at address **N**. The application of block numbers in blocks is *not compulsory*.

Block numbering can be automatized. If value of parameter 0567 **N STEP** is other than 0, the block number is increased by the value given at the parameter for each push of the <ENTER>

key  and this is automatically inserted to the beginning of the new block at address **N**. If

for example the value of parameter is 10 the block numbers are increased by ten: N10, N20, N30, ...

Comments starting by character "(" and ending by character ")" can also be written in the blocks.

#### *Program number and program name*

The program number and program name are used to identify the program. Usage of program number is mandatory, that of a program name is not. The program number is the exclusive identifier of the program in the directory, while the program name plays only informatory roles. The address of program number: **O**. The address must always be followed by 4 digits, i.e., *the leading zeros must also be filled in*.

The program name is an arbitrary string between opening and closing brackets "(" and ")". The program number and the program name are separated from the rest of program blocks in memory by character **LF**.

*Beginning and end of program*

The program begins and ends with character %.

As a new program is loaded with the help of NEW action on DIRECTORY screen string

%OnnnnLF%

is formed automatically.

*In the course of editing a part program on the CNC the opening and closing % characters and the program number (Onnnn) do not appear in the program list and edit field therefore they can not be altered.*

If one edits a part program on an external device e.g., on a PC the opening and closing % characters and the program number (Onnnn) must be typed in.

*Program format in memory*

The program in memory is a set of ASCII characters. Its format is:

%O1234(PROGRAM'S NAME)LF/1 N12345 G1 X0 Y...LFG2 Z5....LF.....LF.....LFG0  
G40...M 2%

In the above string:

LF represents Line Feed character,

% stands for the beginning and end of program.

*Program format in case of communicating with an external device.*

The above program format is applicable also in case of communicating with an external device.



## 4.2 Division of EDIT Screen during Editing

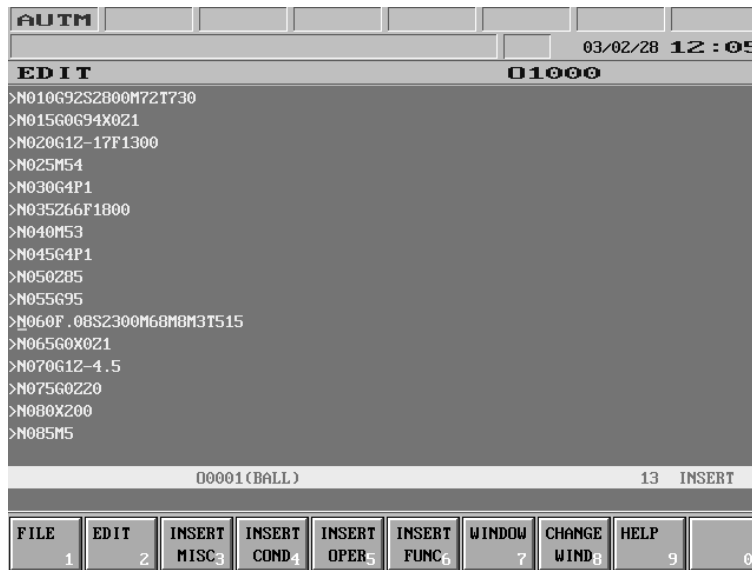

19 lines are kept for editing in the middle of screen. The division of these is as follows:

### Lines ranging from No. 1 to No. 16: program list and edit field.

In the **first column** only character > representing a new block, i.e., code  $\text{L}_F$  may appear. The first character of the block occurs in the second column. Otherwise if a new line must be opened on screen for the block does not have enough room in one line, the first column remains empty.

The text runs from the 2<sup>nd</sup> column to the 80<sup>th</sup> column and in case there are more than 79 characters in one line the text goes on in the next line.

If the last character of the word is over the 79<sup>th</sup> **column** the whole word occurs in the following line starting from the 2<sup>nd</sup> column.

### Line No. 17 is empty.

### Line No. 18 is a status bar.

Texts written here are highlighted.

The structure of the line is as follows:

| **message** | **window1** | **window2** | **line number** | **operation mode** |

*message*: error messages are displayed here.

*Window1*: the number of program (Onnnn) edited is shown here as well as its name of which is displayed as much as possible. In case two windows are applied the number and name of the opened program in the upper window are displayed.

*Window2*: the number of program (Onnnn) being in the second, lower window is shown here as well as its name.

*Line number*: number of logic lines (blocks, characters  $\text{L}_F$ ).

*Operation mode*: INSERT or OVERWRITE.

The program number of the active window is highlighted.

### Line No. 19.: editor error message and data input line.

This is the field for the display of error messages sent by the editor and for data input in the course of different actions (e.g., search).

### 4.3 Basic Editing Functions: Typing, Cursor Moving, Delete, Insert, Select

The editing gets started as the effect of **action menu** key .

Basic editing functions are implemented with the help of the following keys:

– characters: <A>, <B>, ... <Z>. By their use capital letters can be typed in.



– Shift button: . In case the key is kept pressed down and another key is pushed meanwhile, the second character indicated on the key is entered. Should letter keys be pushed and no secondary character shown on it, small letters are typed



– digit keys: <0>, <1>, ...<9>

– space: 

– decimal point: 

– minus character <-> (does **not** switch sign during program editing): 

– move cursor up, down: , 

– move cursor right, left: , 

– new line ( $\text{LF}$ ): **(Enter)** 

– go backwards and delete: **(Backspace)** 

– delete: **(DEL)** 

– insert: **(INS)** 

– page up: **(PgUp)** 

– page down: **(PgDn)** 

#### *Typing*

Characters, signs and the space can be entered uninterruptedly by pressing down the appropriate key or keys. The place of input is where the cursor points at.

#### *Word wrap*

Should a word (a string between two spaces) exceed the length of the given line while typing the editor displays the whole word in a new line.

#### *New block*

During program editing termination of a block is performed by pressing <ENTER> key 

due to which line feed occurs and at the same time character  $\text{LF}$  is adjusted to the end of the terminated block automatically. As the effect of the key the cursor goes to the beginning of the next line and the input of a new block can be initiated.

If value of parameter 0567 **N STEP** is other than 0, the block number is increased by the value given at the parameter for each push of the <ENTER> key  and this is automatically inserted to the beginning of the new block at address N.

If for example the value of parameter is 10 the block numbers are increased by ten: N10, N20, N30, ...

### *Moving the cursor*

As the effect of right key  the cursor goes to the next character. Should the line (last character or space) on the screen end earlier than the right verge of screen, the cursor goes to the first character of the following line, if there is. If the text ends there the cursor stands still.

As the effect of left key  the cursor goes to the previous character. Should it be on the left verge of the screen, the cursor goes to the finishing character of the previous line, independent of where the previous line ends. If the text starts there the cursor stands still.

As the effect of down key  the cursor goes to the following line. Should there neither be character nor space in that column of the next line it goes to the last character of the line. If there is no text in the succeeding line what so ever the cursor stands still.

As the effect of up key  the cursor goes to the previous line. Should there neither be character nor space in that column of the last line it goes to the last value character of the line. If there is no text in the previous line what so ever the cursor stands still.

As the effect of the page down key  the cursor goes to the following page, so that a whole block is seen on the bottom of screen and it appears after the last character of the block.



As the effect of the page up key  the cursor goes to the previous page so that the first line of the screen always shows the beginning of a block (code  $\text{LF}$ ) and it appears on the first character. In case no more paging can be done, it goes to the first character of the text.

### *Delete*

When pressing key <DEL>  the character on which the cursor stands is deleted, while the characters behind step forward. If due to this, the word in the next line has now enough room in this line, it also steps forward.

In case a space separating two words is deleted, the word drawn together is written in one. Should the space be at the end of a line, i.e., the two words be in other lines (and the block not finished yet, i.e., the following character not being  $\text{LF}$ ) the word is written in one and occurs together with the cursor in the succeeding line.

If characters are deleted from a word at the beginning of the line and the shortened word can already be displayed in the previous line the word together with the cursor occurs there. If when pressing delete key the cursor stands after the last character of a logic line (block) linefeed character  $\text{LF}$  is deleted and the two blocks are drawn together.

As the effect of backspace key  the character before the cursor is deleted and the characters behind step forward. Regarding logic lines (blocks) the same rearrangements are in force as those referring to delete key .





### ***Insert***



When opening, the editor accepts insert mode indicated by caption INSERT on the right side of the 18<sup>th</sup> line of screen.. After pressing key <INS>  the caption and the mode change to



OVERWRITE. Afterwards by pressing key  repeatedly the state changes to its reverse.



In insert state the new character is written in the position preceding the cursor. Regarding the new word formed due to the insert the same rearrangements (word wrap) are in force as those referring to deleting.

### ***Select***

Selection is implemented by the simultaneous pressing of key <SHIFT>  and cursor moving keys , , , .

The selected text is shifted one character right by means of keys  and ,

one character left by means of keys  and ,

one line down by means of keys  and ,

one line up by means of keys  and .

Selection is deleted with the help of cursor moving keys of the contrary direction.

### ***Deleting the selected text***

The selected text is deleted by means of key del .

### ***Value range test***

The editor does not make any sort of value range or other syntactic test.

#### 4.4 Editor Action Menu

The following actions as well as action groups are available for editing, when **action menu** key



is pressed:

File	Edit	Insert	Insert	Insert	Insert	Window	Change	Help	
1	2	misc 3	cond 4	operat 5	funct 6	7	wind 8	9	0

#### 4.5 File Actions: Save, Save as

<b>File</b>	Edit	Insert	Insert	Insert	Insert	Window	Change	Help	
1	2	misc 3	cond 4	operat 5	funct 6	7	wind 8	9	0

The following actions are accessible by selecting File action group F1.

			Save	Save					
1	2	3	4	as... 5	6	7	8	9	0

**Save Action:** The edited program is saved while exiting from EDIT screen (by the use of key ) as well as periodically in the course of editing. This action must be applied when for the sake of security an important part of the program is to be saved.

**Save as Action:** In case a program is to be saved with another number in the bottom data input line message

FILE NAME: Ommn\_

appears when pressing the key. Program number O can be overwritten and the action can be terminated by means of key <ENTER> .

Should the program with the entered number be an already existing one in the memory, message

FILE NAME: Ommn\_ EXISTING FILE. OVERWRITE? Y/N

is displayed. By pressing key <Y> the program is overwritten, while with key <N> another program number may be given.

#### 4.6 Edit Actions: Undo, Cut, Copy, Paste, Find and Replace

File	<b>Edit</b>	Insert	Insert	Insert	Insert	Window	Change	Help	
1	2	misc 3	cond 4	operat 5	funct 6	7	wind 8	9	0

The following actions are accessible by selecting Edit action group F2.

Undo	Cut	Copy	Paste	Select	Find/	Find	Find	Replace	
1	2	3	4	all 5	replac 6	next 7	previ 8	9	0

**Undo Action:** In case an action whether it is typing or deleting is executed within a block, by the use of this key the previous state can be restored. If the result of editing can be undone, the caption of the key is light, otherwise it is dark. The deleting can be undone as far as character  $\perp$  closing the block is not deleted.

**Cut Action:** By pressing the key the block selected earlier on is deleted from the text and put to the clipboard.

**Copy Action:** By pressing the key the text selected earlier on is put to the clipboard and the original text remains at its position.

**Paste Action:** By pressing the key the content of the clipboard is inserted starting from the position next to the cursor. In case the clipboard is empty, the caption of the key is dark, otherwise it is light.

**Select All Action:** By pressing the key the entire program is selected.

**Find/Replace Action:** By pressing the key it remains pressed down. Captions

FIND: <empty>

REPLACE: <empty>

appear in the bottom data input line. Afterwards the text to be searched for can be typed in the field after caption FIND. In case the text typed in is to be changed to another one the cursor goes to the field next to caption REPLACE on the right side of the screen as the effect of key <ENTER>  where the desired text can be written

in. By the repeated pressing of key <ENTER>  the cursor swings between captions FIND and REPLACE, therefore each text may be modified additionally. The maximum length of the text to be found or replaced is 30 characters.

In case a text is selected before pressing **Find/Replace** key the selected text is displayed automatically after caption FIND.

By a repeated push the **Find/Replace** key is unpressed and the cursor goes back to its original position in the selected text. By the repeated pressing of **Find/Replace** key the text written in earlier on is restored in the bottom data input line after captions FIND and REPLACE.

**Find Next Action:** In the pressed-down state of **Find/Replace** key as the effect of **Find Next** key search for the text given in FIND field is executed forwards from the position in which the cursor stood before the pressing of **Find/Replace** key. The found string can be seen in inverse mode in accordance with the selection. After the unpressing of **Find/Replace** key the cursor glitters in the first character position of the found text and the selection disappears. Should the string be not found the caption NOT EXISTING is displayed in the message field. The message is *cleared* by the repeated press of

**Find/Replace** key, **Find Previous** key or the Cancel key  as well as **Find Next** key provided the text in FIND field is in the meantime changed and found.

**Find Previous Action:** In the pressed-down state of **Find/Replace** key as the effect of **Find Previous** key search for the text given in FIND field is executed backwards from the position in which the cursor stood before the pressing of **Find/Replace** key. The found string can be seen in inverse mode in accordance with the selection. After the unpressing of **Find/Replace** key the cursor glitters in the first character position of the found text and the selection disappears. Should the string be not found the caption NOT EXISTING is displayed in the message field in the 18<sup>th</sup> line. The message is *cleared* by the repeated pressing of **Find/Replace** key, **Find Next** key or Cancel key

 as well as **Find Previous** key provided the text in FIND field is in the meantime changed and found.

**Replace Action:** After a successful search for the next or last string in the pressed-down state of **Find/Replace** key, when the found text is inversed **Replace** key may be pressed. In this case the string after the caption REPLACE is inserted in the text in place of the

found string. If no text is given after the caption REPLACE, **Replace** action is equivalent to the deleting of the found text. **Undo** action can also be applied after **Replace** action.

#### 4.7 Insert Actions

File	Edit	Insert	Insert	Insert	Insert	Window	Change	Help	
1	2	misc 3	cond 4	operat 5	funct 6	7	wind 8	9	0

The following actions are accessible by selecting action groups F3, ..., F6:

##### **Insert Miscellaneous Action Group:**

Number	Date/time	WHILE	DO	END	BPRNT	DPRNT	POPEN	PCLOS	SETV
1	2	3	4	5	6	7	8	9	N 0

##### **Insert Condition Action Group:**

IF	LT	LE	EQ	NE	GE	GT	GOTO	THEN	
1	< 2	<= 3	= 4	!= 5	>= 6	> 7	8	9	0

##### **Insert Operation Action Group:**

ABS	BIN	BCD	FIX	FUP	NOT	OR	XOR	AND	MOD
1	2	3	4	5	6	7	8	9	0

##### **Insert Function Action Group:**

SIN	COS	TAN	EXP	ASIN	ACOS	ATAN	LN	SQRT	
1	2	3	4	5	6	7	8	9	0

**Number Action:** The line number seen in the status line is multiplied by the value of parameter 0567 N STEP and the block number (Nnnnnn) resulted is inserted after the position indicated by the cursor.

**Date/Time Action:** By pressing the key the date and time are inserted in the text as seen in the top right corner of the screen.

By selecting further actions of the four action groups executing insertion, the string corresponding to the caption of the key is inserted in the text.

#### 4.8 Actions of Window

File	Edit	Insert	Insert	Insert	Insert	Window	Change	Help	
1	2	misc 3	cond 4	operat 5	funct 6	7	wind 8	9	0

**Window Action:** By pressing the key it remains pressed down and the edit field of the screen is divided horizontally into two windows. In both windows the program selected for editing can be seen, making thereby possible the editing of two different parts of the same program. In case another program is to be presented in a window the editing must be exited and the program to be loaded must be selected on the DIRECTORY

screen. By returning to the EDIT screen the other program can be seen in the window active when exiting. The active window as well as the program numbers shown in the windows are indicated in the 18<sup>th</sup> status line. The cursor is seen in the active window, and this is also the place where editing actions may be executed.

By a repeated push the **Window** key is unpressed, the screen is switched back to single window form and the program, the window of which was active at the time of the pressing of **Window** key, can be continued to be edited.

**Change Window Action:** Applied when two windows are present at a time. As its effect the cursor goes to the other window. Henceforward the other window is active and editing actions can be realized there.

#### 4.9 Help

File	Edit	Insert	Insert	Insert	Insert	Window	Change	Help	
1	2	misc 3	cond 4	operat 5	funct 6	7	wind 8	9	0

**Help Action:** The pressing of the key is only effective if the cursor is moved to the letter G of a G code (e.g., G02) or if previously a G code interpretable by the help function is selected in the text by means of shift and cursor moving keys, i.e., according to the rules of selection. The key remains pressed down. By the repeated push of the key the help is closed.



## 5 Switching Over Operation Modes

With the help of the **data input keyboard** the state of operation modes, switches, etc., displayed on the OPERATOR'S PANEL screen can be changed by means of softkeys after **action menu** key has been pressed. The above switches are available not only on the OPERATOR'S PANEL screen, but also on POSITION screens. These are discussed in details in the chapters of the appropriate screen.

When switching over an operation mode, at first one of the below screens (functions) must be selected: OPERATOR'S PANEL, or POSITION.

Afterwards by pressing the **ac-**

**tion menu** key  F1

MODES action menu needs to be selected. In this case the captions of different operation modes appear on the menu bar. The desired operation mode can be displayed by pressing the appropriate softkey.

If the machine is mounted with NCT machine control board the operating modes can be selected directly from the pushbuttons.



### Note:

*In the different computers the operation mode selection can function contrary to the above-mentioned process. For example operation mode selector switches can be equipped to the machine and the operation modes can be switched over directly by the use of these. It is possible, that in this case operation modes cannot be selected by means of softkeys at all. For details turn to the machine tool builder for an information material.*

## 6 Manual Operation Modes

The manual operation modes are as follows:

- Manual reference point return
- Manual handle feed
- Incremental jog
- Jog

### 6.1 Manual Reference Point Return Mode

Reference point can be returned only upon power-on state of the machine, i.e. when there is no **EMG** (emergency stop) state in the rightmost field (general NC state) of status bar. If one of the axes has not been returned to the reference point, in case of that axis no absolute positioning (G90) can be programmed. The parametric overtravel also functions only after the reference point return. The reference point return mode is indicated by caption **REF** in the 2<sup>nd</sup> field of the status bar.

If the machine is mounted with NCT machine control board the reference point return mode can be switched on by pressing the  button.

#### Axis Selection

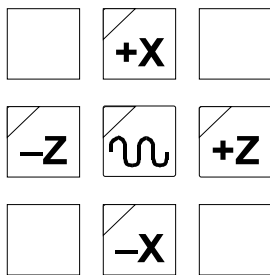

After selecting the operation mode by pressing and holding down the appropriate axis's button returning to the reference point on the selected axis is beginning. If the axis direction button is not held down any longer the movement stops, if it is pressed again the process is continued. More axes' jog buttons can be pressed at a time, therefore return to reference point can be made simultaneously on several axes.

On the selected axis the direction of movement depends on the parameter and independent of whether key of direction + or key of direction - is being pressed. Generally on the control panels +X, -X, +Z, -Z are equipped. This way the movement on axes X, Z can be directly started.

If the ABSOLUTE POSITION screen is used during reference point return, on the axes, on which return to reference point has already occurred, symbol  $\checkmark$  is displayed beside the position, while on the ones, on which no return to reference point

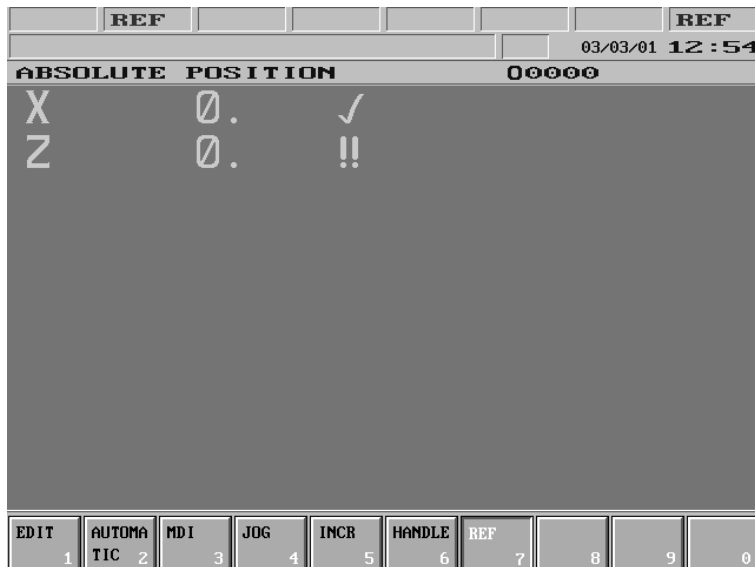

happened yet, symbol **!!** can be seen beside the position. In case the reference point has been returned on all axes **REF**, i.e., the caption indicating lack of reference position is cleared from the general NC state field.

 *Note:*

*By different machine tools return to the reference point may function contrary to the above-mentioned process. It is common, that after displaying the operation mode and pressing START button the jog buttons are to be held down for a short time, after that the process goes on automatically. In this case the process can be stopped by pressing STOP button. For details turn to the machine tool builder for an information material.*

### **Types of Reference Point Return**

There may be four types of reference point return. The types are determined by the machine tool builder axis by axis in different parameters, in function of the adapted path measuring system.

#### 1. Reference point setting by return to switch, then standing on zero-pulse

The selected axis runs to the reference point switch at high speed, then stops. It comes off the switch at low speed either in the direction of the running on or in the opposite one, and searches for the first zero-pulse, and registers this position reference point.

#### 2. Reference point return with distance coded measuring system

The selected axis searches for two neighboring zero-pulses at low speed. It detects the absolute position of the axis by measuring the distance between the two zero-pulses.

#### 3. Reference point return on grid

The selected axis searches for the zero-pulse at low speed and registers it as reference point.

#### 4. Floating reference point



By pressing the appropriate jog button no movement is made, but the momentary position of the slide is registered as reference point.



## 6.2 Jog Mode





Jogging can only be done upon power-on state of the machine, i.e. when there is no **EMG** (emergency stop) state in the rightmost field (general NC state) of status bar. After selecting the operation mode in the 2<sup>nd</sup> field of status bar caption **JOG** appears.

If the machine is mounted with NCT machine control board the jog mode can be switched on by pressing the  button.

### Axis Selection



 The movement on axes X, Z can be directly started by pressing and holding down the appropriate jog button.



 More axes' jog buttons can be pressed at a time, therefore more axes can be jogged simultaneously.





 In case only jog buttons are held down the appropriate axis is jogged at feedrate. If together with the jog buttons the rapid traverse key is pressed, the selected axes move at rapid traverse rate.

### Feedrate Selection

Rate of feed jogging:

- the modal value F, if the value of parameter 1372 JOGFEED is 0.
- If the value of parameter 1372 JOGFEED is 1 the rate of jogging is independent of the modal value F. In this case the rate is taken into account on the basis of the state of feedrate override switch in accordance with the table beside.

In this case the valid feedrate values can be seen in the 5<sup>th</sup> (interpolator) field of status bar.

%	G21 mm/min	G20 in/min	rotating axis °/min
0	0	0	0
1	2	0.08	0.4
2	3.2	0.12	0.64
5	5	0.2	1
10	7.9	0.3	1.58
20	12.6	0.5	2.52
30	20	0.8	4.0
40	32	1.2	6.4
50	50	2	10
60	79	3	15.8
70	126	5	25.2
80	200	8	40
90	320	12	64
100	500	20	100
110	790	30	158
120	1260	50	252

The rate of rapid traverse jogging is at parameters axis by axis fixed value. Generally the rate differs from (less than) that of G00 rapid traverse rate positioning (by the way it is also fixed at parameters axis by axis).

**Note:**

*The above discussed cases are the basic cases of jog mode. By different machines functions contrary to these may be created by the machine tool builder. It is common, for example, if pressing of a jog button is followed by the pressing of the START button, than the jog button is not to be held down any longer. This way the movement on the selected axis is carried on until the STOP button is pressed. For details turn to the machine tool builder for an information material.*

### 6.3 Incremental Jog Mode





Incremental jogging can only be done upon power-on state of the machine, i.e. when there is no **EMG** (emergency stop) state in the rightmost field (general NC state) of status bar. After selecting the operation mode in the 2<sup>nd</sup> field of status bar caption **INCR** appears.

If the machine is mounted with NCT machine control board the incremental jog mode can be switched on by pressing the  button.

#### Increment Selection

After selecting the operation mode an increment size must be selected. This can be done on the OPERATOR'S PANEL or POSITION screen. After pressing the **F3 action menu** key INCREMENT, the desired increment size can be selected with the help of softkeys. The selected increment size can be seen in the 5th (interpolator) field of status bar. The increment size means the number of increments the selected axis moves by pressing the axis direction button once.



If the machine is mounted with NCT machine control board the increment size can also be selected directly by buttons , , , .

The increment size stepped by the control (1, 10, 100, 1000 increments) is always interpreted in the output system of the machine (metric or inch). The output increment system is determined by the measuring system adapted to the machine. If, for example, in case of a machine of metric system (the output increment system is metric), the resolution is 0.001mm, the control is set to G20 (inch input programming) state and 1000 increment size is selected, on the position display of distance to go 0.0394 will be displayed as distance, which is 1 mm increment size in inch.

If data input and position display is done in diameter on axis X, the selected incremental step will be done in diameter too.

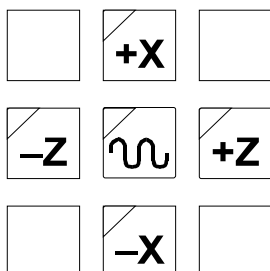

#### Axis Selection

After setting the increment size by pressing axis jog buttons the step is started on the selected axis and in the selected direction.

**⚠Warning!**

*If in case of greater increment sizes the jog button is left hold for a short time, the movement stops and the desired distance is not stepped by the control, this way preventing it from possible collisions!*

### 6.4 Manual Handle Mode

Moving by the use of manual handle can only be done upon power-on state of the machine, i.e. when there is no **EMG** (emergency stop) state in the rightmost field (general NC state) of status bar. After selecting the operation mode in the 2<sup>nd</sup> field of status bar caption **HNDL** appears.

If the machine is mounted with NCT machine control board the manual handle mode can be switched on by pressing the  button.

#### Increment Selection

After selecting the operation mode an increment size must be selected. The selection and interpretation of increment size correspond to the ones discussed in the case of incremental jog mode. The increment size in manual handle mode shows the number of increments the slide moves by rotating the manual handle one unit of division.

#### Axis Selection

The axis to be moved by the manual handle can be selected on the OPERATOR'S PANEL or POSITION CHECK screen. After pressing the **action menu key** **F2** AXES than the axis to be moved can be selected by means of softkeys.

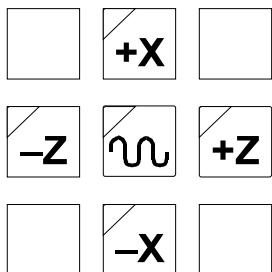

If the machine is mounted with NCT machine control board the axis can also be selected by the jog buttons X, Z. In this case after selecting the appropriate axis the lamps of both directions (e.g., +X and -X) are alight.



## Speed

In case of moving by the use of the manual handle the speed of the axis depends upon the selected increment size and upon the speed of the rotation of the handle. The movement is started by acceleration and finished by deceleration. The pulse number rotated is always executed, if parameter 1373 HNDLFEED is 0 therefore, if the selected axis cannot follow the pulses coming from the manual handle those are buffered and are moved after the rotation has been stopped. Adjust parameter 1373 HNDLFEED=1 to avoid such undesired pulse buffering. In this case the division on the handle may differ from the movement actually done.

*Note:*

*The above discussed case is the basic case of manual handle mode. By different machines functions contrary to these may be created by the machine tool builder. If, for example, an external manual handle is equipped, the increment and direction selection may be done with the help of a dial. For details turn to the machine tool builder for an information material.*

## 7 Actions Executed in Manual Operation Modes

### 7.1 Single Block Operation

A single block can be entered by selecting BLOCK INPUT screen of the PROGRAM screen menu and pressing the **action menu** key. This action can be used only in **jog, incremental jog** and **manual handle modes**. The data input is discussed in the chapter [3.3.4](#) “**SINGLE BLOCK Screen**” on the page [34](#).

Only a program block not referring to previous or following blocks can be entered, i.e., for example a block containing tool nose radius compensation cannot be entered. There are no further restrictions, e.g. canned cycles, subprograms or macros can be started by means of single block operation.

After terminating single block input caption **SBEX** appears in the 2<sup>nd</sup> field of status bar. With the START button in effect the single block is executed.

### 7.2 Work Zero Point Offset and Tool Length Offset Measurement

In the course of measuring work offsets and tool length offsets by touching the workpiece surface, of which the sizes are known, manual moving of axes is needed. It follows, that it is practical to use manual operation modes in case of both activities. If, when measuring, switch-over of spindle revolution or a new tool is needed, it can be executed by means of single block input without changing operation modes.

 *Warning!*  
*Work offset and tool length offset measurement can be executed only after reference point return.*

### 7.2.1 Work Zero Point Offset Measurement

If work offset is to be measured **inside the machine**, select  $F^3$  W. OFFS MEASURE (work offset measurement) screen of OFF-SETS screen menu and press the **action menu** key.

**The coordinate system to be measured can be selected** after pressing softkey  $F^1$  WORK COORDNT. (Work coordinate system), than the appropriate softkey  $F^1$  G54,  $F^2$  G55, ... *The selected coordinate system is not changed to (as after the execution of the appropriate command G54, G55, ...), but is only taken into account in the course of measuring.*

HNDL		10		03/02/28 12:15					
WORK OFFSET MEASURE				01000					
MACHINE	G54	ABSOLUTE	END POS.						
X 290.480	X 413.930	X 413.930							
Z 180.805	Z 448.696	Z 448.696							
F 300.0000	300.0000	100%	100%						
S 500	0	100%	G54						
GEOMETRY WEAR									
N01 X	- 126.480	0.000							
Z	28.420	0.000							
WORK1 G54									
X-	123.450	Z-	267.891						
X	123.4								
WORK COORD1	OFS. N 0 SEA2	/2 3	BLOCK INPUT4	5	6	7	8	9	0

Basically there may be two kinds of tool length offsets. One possibility is that the tool length offset equals to the X- and Z-direction tool **overhang**. Another one is that the tool length is actually a coordinate **offset** in the direction of tool length. The control enables the operator to take the size of a tool which is known, into account when measuring the offsets.

The **length offset storage** to which the coordinate system is to be measured, can be selected. In order to do this the action key  $F^3$  OFS NO SEARCH (offset number search) must be pressed. The offset register number, which is to be used in the course of measuring, shall be entered under address N in the bottom data input line, than the data input must be terminated by either key  or .

### Work Zero Point Offset Measurement, if Tool Length Equals to Tool Overhang

If tool length equals to the X- and Z-direction tool overhang (because for example tool offset measuring was executed on an external measuring device) the work offset (work zero point) **must always be measured**. This can be done by taking a cut with a tool previously measured, in X- and Z-direction on the workpiece in the spindle, than measuring the diameter and length of workpiece on the place where the cut was taken and entering the sizes to control. The control takes the tool overhang into account automatically when calculating the work zero point offsets, if prior thereto the tool offset group containing its size was selected.

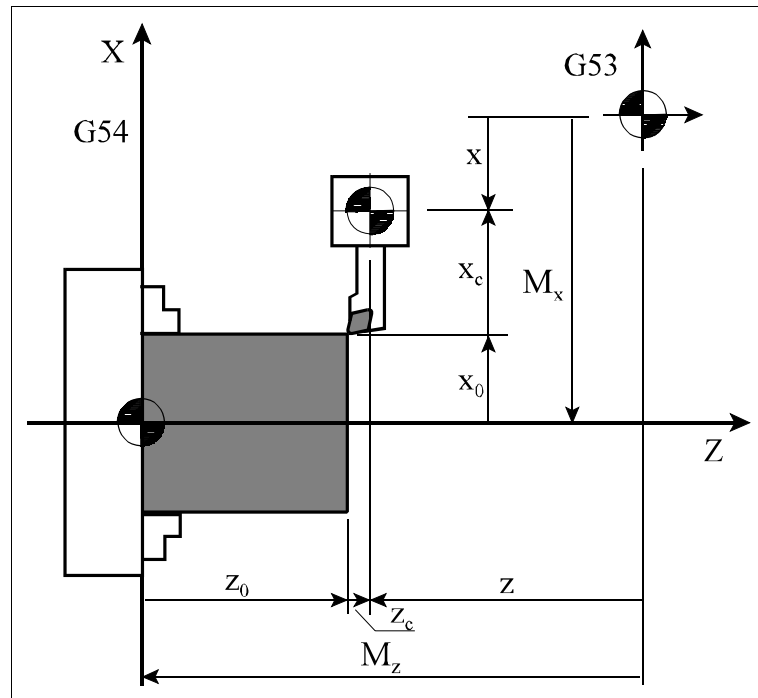

The offset value can be calculated from the following equation:

$$M_x = x - x_c - x_0$$

$$M_z = z - z_c - z_0$$

where

- $M_x, M_z$ : value of work zero point offset
- $x, z$ : reference position of tool holder in machine coordinate system (excluding length offset)
- $x_c, z_c$ : X- and Z-direction tool length offset
- $x_0, z_0$ : data entered to coordinate Z in the course of measuring, the measured size of the workpiece.

*Note:*

*Values  $x$  and  $z$  of the above equation differ to position seen on position display G53, if tool length has been called (Tnnmm). In values " $x, z$ " the called length offset is never taken into account. Therefore before measuring it is useful to delete tool length by means of command Tnn00, however this only makes position display more understandable.*

### Work Zero Point Offset Measurement, if Tool Length Equals to Coordinate Shift

If tool lengths are measured so that they also contain the offsets of the work zero point (see tool length measurement) work offsets do not have to be measured. An exception to this is if the offset needs to be compensated, as well as if another work coordinate system is to be used. This is needed, for the tool length is calculated in relation to a given work coordinate system.

The process corresponds to the above discussed one. The control calculates the offset amount with the help of the above-mentioned equation:

$$M_x = x - x_c - x_0$$

$$M_z = z - z_c - z_0$$

However this time the offset of the new coordinate system (G55) is shifted in relation to the previous one (G54), as seen on the diagram beside.

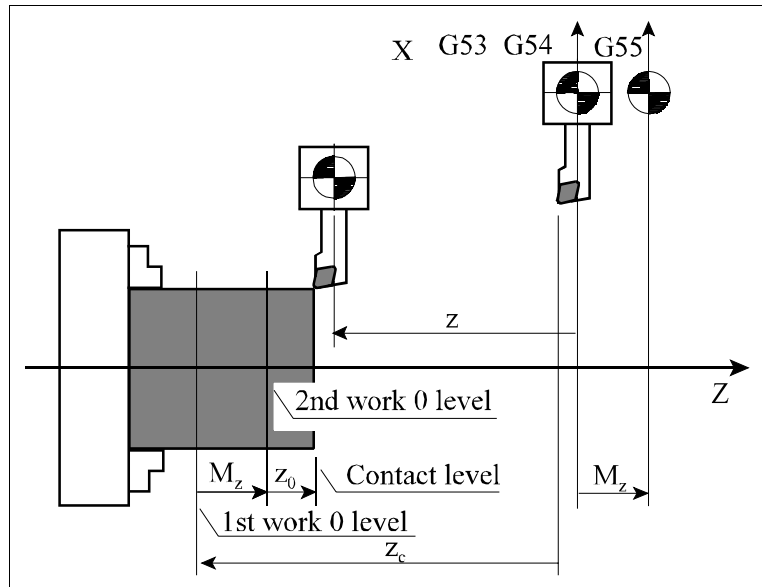



### 7.2.2 Tool Length Offset Measurement inside the Machine



Tool length can be measured also **inside the machine**. For this softkey <sup>F4</sup>T. LENG MEAS-UR (tool length measurement) of <sup>F5</sup>OFFSETS action menu must be selected.

Select the **tool length offset register**, in which the tool length to be stored. In order to do this softkey <sup>F3</sup>OFS NO SEARCH (offset number search) must be pressed. The offset register number, which is to be used in the course of measurement, shall be entered under address N in the bottom data input line, than the



data input must be terminated by either key  or .

The **coordinate system**, to which the tools are to be related to, needs to be **selected** after pressing softkey <sup>F1</sup>WORK COORDNT. (Work coordinate system), than the appropriate softkey <sup>F1</sup>G54, <sup>F2</sup>G55, ... *The selected coordinate system is not changed to (as after the execution of the appropriate command G54, G55, ...), but is only taken into account in the course of measurement.*

After taking cuts on X and Z axes, measuring the diameter X and length Z of workpiece cut, the values are to be specified in the lower data input line on address X and Z. The data input must be terminated by either key  or .

The control calculates the tool length offset automatically by taking the current axis position into account.

### If No Work Zero Point Offset Measurement had Taken Place Previously

If no work zero point offset had taken place previously, the appropriate work offset of the selected coordinate system is zero ( $M_x=0, M_z=0$ ). The coordinate values measured after cutting and entered to control at addresses X and Z:  $x_0, z_0$ . The control calculates the tool length with the help of the relation, discussed for work zero point offsets, as seen on the diagram.

$$x_c = x - x_0 - M_x$$

$$z_c = z - z_0 - M_z$$

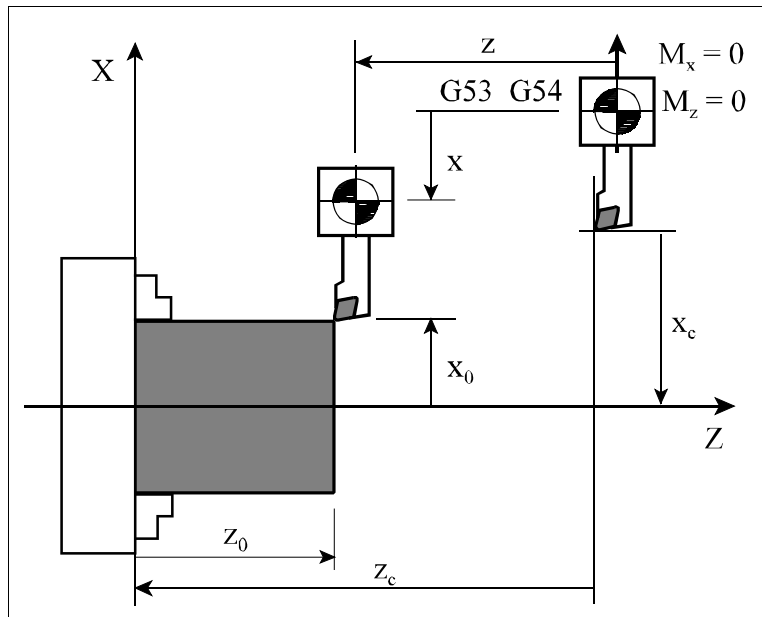

### If Work Zero Point Offset Measurement had Taken Place Previously

After entering the coordinates the tool length is calculated with the help of the following equation:

$$x_c = x - x_0 - M_x$$

$$z_c = z - z_0 - M_z$$

where

- $x_c, z_c$ : length offset calculated by the control
- $x, z$ : reference position of the tool holder in the machine coordinate system (excluding length offset)
- $x_0, z_0$ : data entered to coordinates X and Z, the known size of the workpiece
- $M_x, M_z$ : Work zero point offset value in the selected coordinate system.

In this case the tool length equals to the tool overhang, as seen on the diagram.

*Note:*

Values  $x$  and  $z$  of the above equation differ to position seen on position display G53, if tool length compensation has been called (Tnnmm). In values "x, z" the called length offset is never taken into account. Therefore before measuring it is useful to delete tool length by means of command Tnn00, however this only makes position display more understandable.

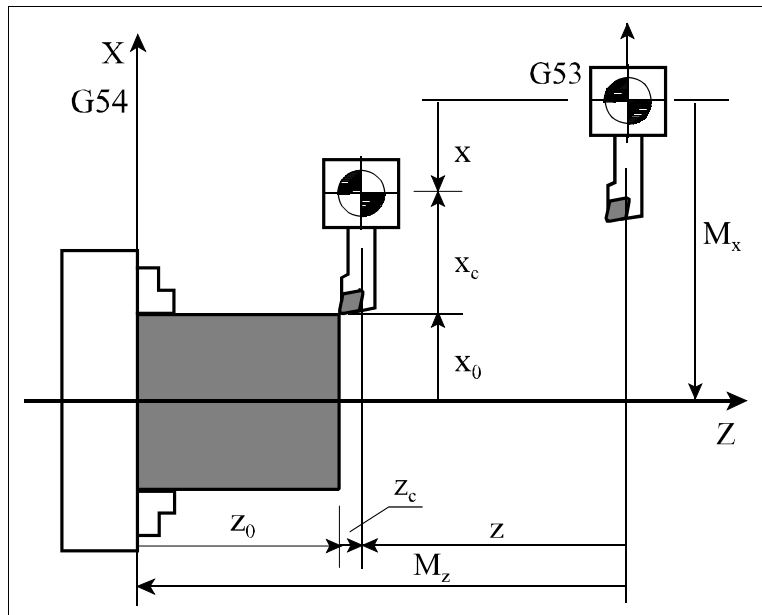

### 7.2.3 Automatic Tool Length Offset Measurement

Tool length offsets can also be measured **automatically**, provided the machine is mounted with a tool offset sensor. Select screen <sup>F4</sup> T LENG MEASURE (tool length measurement) in screen menu of <sup>F5</sup> OFFSETS.

Switch control to **JOG** mode, than **change the tool** to be measured.

Move the **tool tip near to the tool sensor** by the use of jog buttons.

The **length offset register** in which the size of the tool is to be stored must be specified after the action menu button is pressed. Press softkey <sup>F3</sup> OFS NO SEARCH (offset number search).

The number of the offset register to be used for the tool measurement must be written at address N in the data input line than the data input must be terminated by means of button

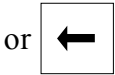

. In case parameter 1353 OFFSNL is set to 1 the cursor moves automatically to the offset register the number of which corresponds to the number of tool activated.

Press softkey <sup>F3</sup> AUTO MEAS after the action menu is pressed.

Press softkey <sup>F3</sup> AUTO MEAS after the action menu is pressed.

**Touch the tool sensor** by moving axis with the appropriate jog button. In this case the speed of movement is always the value defined at parameter 8022 G37FD independent of the override switch state. Even 0% state of the override switch is ineffective, the jog button must be released in order to stop.

As the tool tip touches the appropriate button of the tool offset sensor, the movement stops and only movement in the contrary direction is possible. The control calculates the tool length offset value automatically at the moment when the sensor has been pressed.

The tool offset sensor enables measurement in all four directions (X+, X-, Z+, Z-). It has buttons in all four directions, their positions must be calibrated and stored at parameters previously. The parameters are:

8081 CONTACTX+,

8082 CONTACTX-,

8083 CONTACTZ+,

8084 CONTACTZ-.

The control subtracts value of the appropriate CONTACT parameter from the current position related to the reference point and the difference is referred to as tool length offset at the moment of touch. On the diagram the position of the Z- button of the sensor is defined to chuck's plane.

The control calculates the z-direction length offset with the help of the equation below:

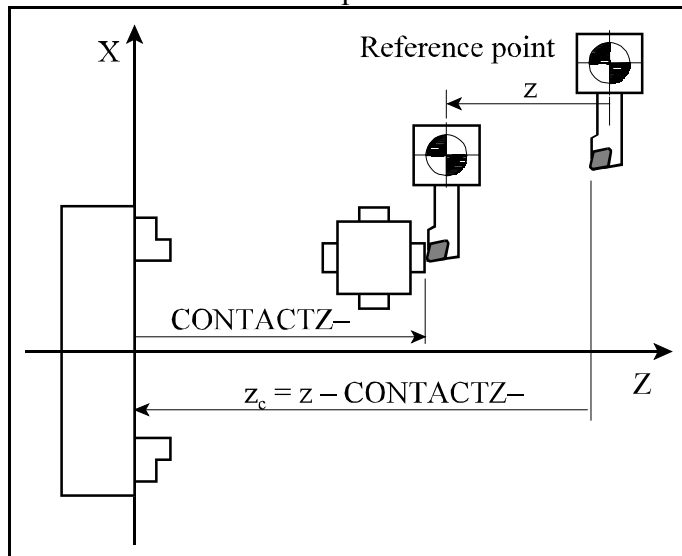

$$z_k = z - \text{CONTACTZ-}$$

where:  $z_c$ : the calculated tool length offset

$z$ : position of the tool holder base point according to the reference point

CONTACTZ-: position of Z- button of sensor registered at parameter

*Warning!*

*The work zero point offset must always be measured after the use of automatic length offset!*



### 7.2.4 Calibrating Tool Offset Sensor

The tool offset sensor calibration means the definition and storage of button positions at parameters CONTACT. The sensor can be calibrated in two ways.

The first possibility is that the button positions of the sensor are defined in a coordinate system set by the user, e.g., a coordinate system fixed to the chuck. In this case the values of tool length offsets contain the zero point offset according to the reference point.

The other possibility is that the button positions of the sensor are defined according to the reference point. In this case the tool length offset value equals to the tool overhang.

*Warning!*

*Parameters 8081 CONTACTX+ and 8082 CONTACTX- must always be specified in radius independent of the default interpretation being in diameter or radius in the control. All CONTACT parameters must be defined in the double of output increment system, i.e. for example in case of metric machine and INCRSYSTB=1 it is in  $\mu\text{m}$  without decimal point.*

*Before the start of the calibration clear all tool length offsets, work zero point offsets as well as all CONTACT parameters.*

### Calibrating the Sensor to the Coordinate System of Chuck

The enclosed diagram beside shows the interpretation of CONTACT parameters.

#### Calibrating in X direction

Turn an optional workpiece, leave the workpiece in Z direction and read the machine position of X axis, indicated with  $X_{workp}$  on the diagram below.

Measure the workpiece diameter indicated with **D** on the figure.

Execute an automatic tool length measure as discussed in the previous chapter in X-direction. Read the selected X offset register value indicated with  $X_{(-)}$  on the diagram.

Calculate and enter the value of parameter CONTACTX- with the help of the following equation:

$$CONTACTX- = [X_{(-)} - (X_{workp} - D)]/2$$

In the above equation X position display is supposed to be in diameter.

The position of X+ button can also be defined by means of the above procedure

#### Calibrating in Z direction

Define the position of tool tip according to the chuck indicated with  $Z_{chuck}$  on the diagram below.

Execute an automatic tool length measurement as discussed in the previous chapter in Z-direction. Read the selected Z offset register value indicated with  $Z_{(-)}$  on the diagram. Calculate and enter the value of parameter CONTACTZ- with the help of the following equation:

$$CONTACTZ- = Z_{(-)} - Z_{chuck}$$

The position of Z+ button can also be defined by means of the above procedure.

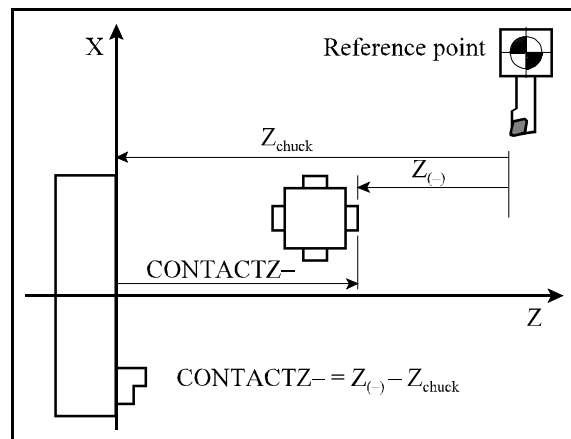
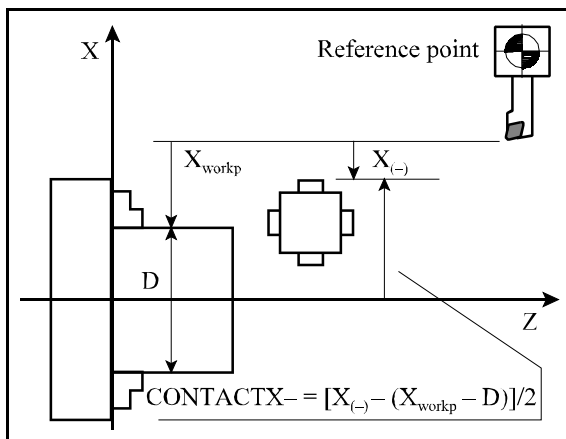
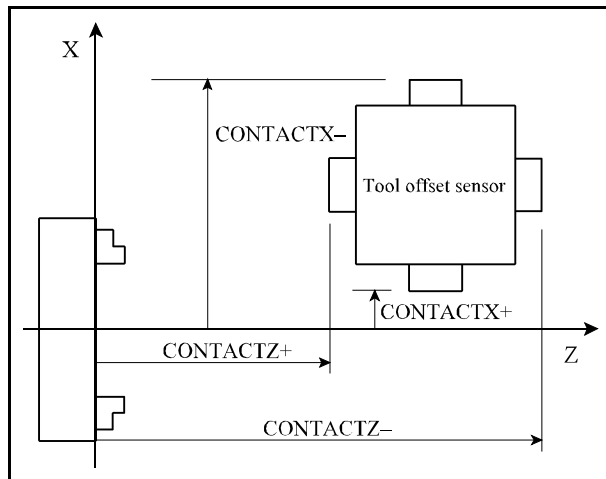

### Calibrating the Sensor to Reference Point

The figure beside shows the interpretation of CONTACT parameters.

Let us examine the following example.

Place a tool, the overhang of which is known in the tool holder. The tool overhang is indicated with  $X_T$ ,  $Z_T$  on the diagram below.

Execute an automatic tool length measurement as discussed in the previous chapter.

On the diagram it is in directions  $X-$ ,  $Z-$ .

Read the selected  $X$ , as well as  $Z$  offset register values indicated with  $X_{(-)}$ ,  $Z_{(-)}$  on the diagram. Calculate and enter the values of the CONTACT parameter with the help of the following equation:

$$\text{CONTACTX-} = X_{(-)} - X_T$$

$$\text{CONTACTZ-} = Z_{(-)} - Z_T$$

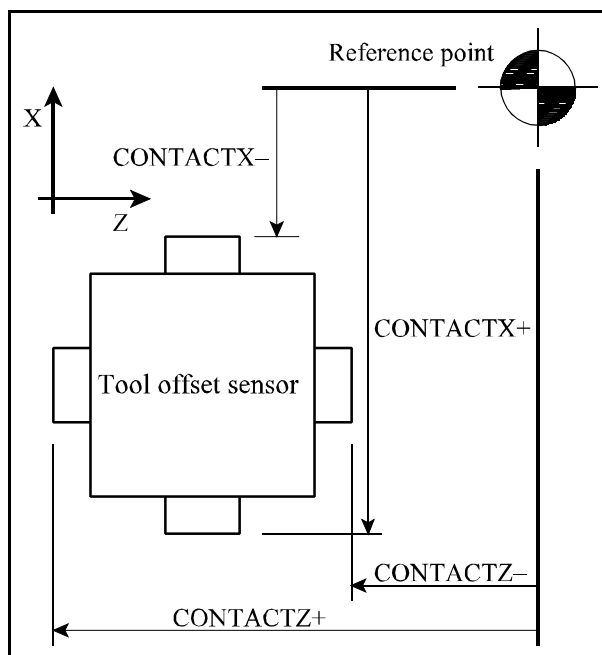

The procedure can also be applied for the other buttons.

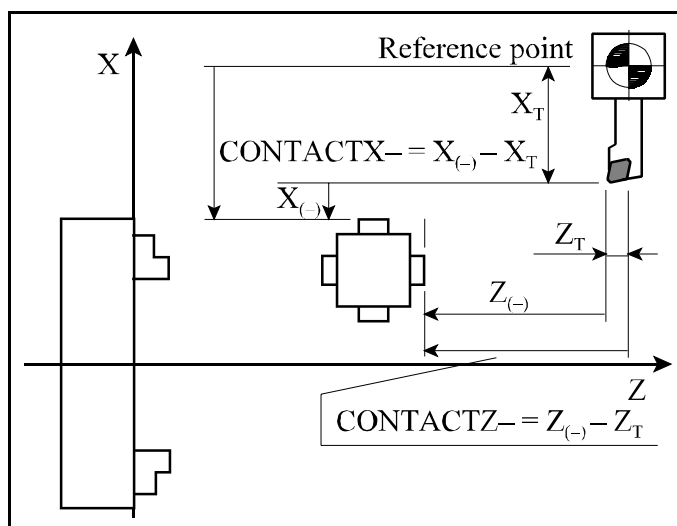

## 8 Modes of Automatic Operation

The modes of automatic operation are:

- Automatic
- Edit
- Manual Data Input

### 8.1 Automatic Mode

Program execution in automatic mode can only be done upon power-on state of the machine, i.e. when there is no **EMG** (emergency stop) state in the rightmost field (general NC state) of status bar.

If the machine is mounted with NCT machine control board the automatic mode can be switched on by pressing  button.

The automatic mode is the operation mode, executing part programs. The part program to be executed can be in the memory of control, as well as in external device, e.g., in a computer. Whether the program to be executed is to be loaded from the memory or from an external device, can be determined, after selecting DIRECTORY screen. After pressing the **action**

**menu** key  RUN action menu must be selected. Afterwards the process corresponds to what have been discussed in chapter **Program directory actions**.

If the program is executed from the memory, caption **AUTM** can be seen in the first field of status bar (first operation mode state), while in case of an external device it is the caption **AUTD** (DNC). The number of the program, selected for automatic execution appears at the end of line containing the name of the current general displaying area.

AUTM		STRT		MOV						03/02/28 11:28
PROGRAM TEXT					01000					
ABSOLUTE		DIST. TO GO		END POS.						
X	280.000	X	0.	X	280.000					
Z	0.357	Z	239.643	Z	240.000					
F	0.0000		0.0000	100%	100%					
S	0		0	100%	654					
> G94 G0 X280										
> Z240										
> T101										
> G52 X4 Z2										
> G42 G0 X210 Z210										
> M3 M8 S500										
> X200										
> G1 Z20 F300										
> G0 X210										
> Z210										
> G0 X200										
> #100=#5001										
TEXT	FUNCTI	LAST	ACTIOE	OPRTR	MESSAG					
1	ON 2	3	4	S PAN 5	E 6	7	8	9	0	

#### 8.1.1 Program Execution in DNC

DNC connection is realized through RS-232C serial interface. Keep an eye on setting the same parameters (baud rate, number of stop bits ect.) on both the transmitter and the receiver side. There may be three kinds of DNC connection.

Simple connection is realized between control and external device upon selection of action DNC of RUN menu. The connection has no protocol, the data can be sent by any serial port driver.

In case of selecting action DNC NCT, program dnc-plus.exe (product of NCT Kft) needs to be

executed on the transmitter side. Program dnc-plus.exe can be executed on IBM PC or on a compatible computer. It ensures connection between transmitter and receiver with protocol. Its advantage over simple DNC connection is that it calculates the checksum by each program block and sends it to control. If the receiver detects an error, it asks for repetition and the transmitter sends the block again. Of this, the operator notices nothing what so ever, for it proceeds automatically. Contrary to simple DNC connection this method makes data transfer very safe, the possibility of mistaking (i.e., control receives false command due to error in data transfer channel) is minimal.

If the option FEW (Floppy Ethernet Winchester) is integrated into the control that is really an integrated PC (Personal Computer), then also action DNC FEW can be selected. Then program execution happens from the PC.

The programs sent in DNC must meet the following requirements:

- no divergence command can be used in main program (i.e. in the program, which is transmitted from external device), such as GOTO or M99 Pnnnn,
- subprogram or macro call is possible with the restriction that the subprogram or macro program must be in the control memory, it cannot be on external device.

### **Machining Start and Stop**

The machining starts with the START button and stops with the STOP button in effect. If no program is selected for execution in automatic mode, and control is not in DNC state, the error message NOT EXISTING PROGRAM is displayed when starting automatic mode.

## 8.2 Edit Mode

In case there is no PLC program or PLC program or parameter area is damaged in control, edit mode is activated after turning the power on. .

Edit mode is indicated by caption **EDIT** in the leftmost field of the status bar. The following actions can only be executed in edit mode:

- editing, as well as loading or saving through serial input the parameter area,
- loading PLC program to control,
- editing programs selected for execution in automatic mode and interrupted during execution, as well as editing sub-programs and macros called from this main program, on condition that those are under processing.

If the machine is mounted with NCT machine control board the edit mode can be switched on by pressing the  button.

### Editing Programs under Automatic Execution

Programs (main programs and sub-programs under automatic execution are indicated by exclamation mark ! standing before their names on DIRECTORY screen. These programs can be edited with the following restrictions.

If automatic mode is interrupted during execution, switch-over to edit mode is done and the screen EDIT is displayed, the control always displays the currently interrupted program, independent of the highlighted program in the list of the directory (indicating the background editing). Editing can be done, beginning with the block after the interrupted program block. The control disqualifies editing of the interrupted block and of previous blocks. If editing of such a block is selected by means of cursor, two arrows →←, pointing at each other indicate in the 7<sup>th</sup> status field, that this block cannot be edited.

The same situation occurs, if execution of a subprogram or macro is interrupted. In this case the subprogram or macro can be modified by opening edit mode with the above restrictions.

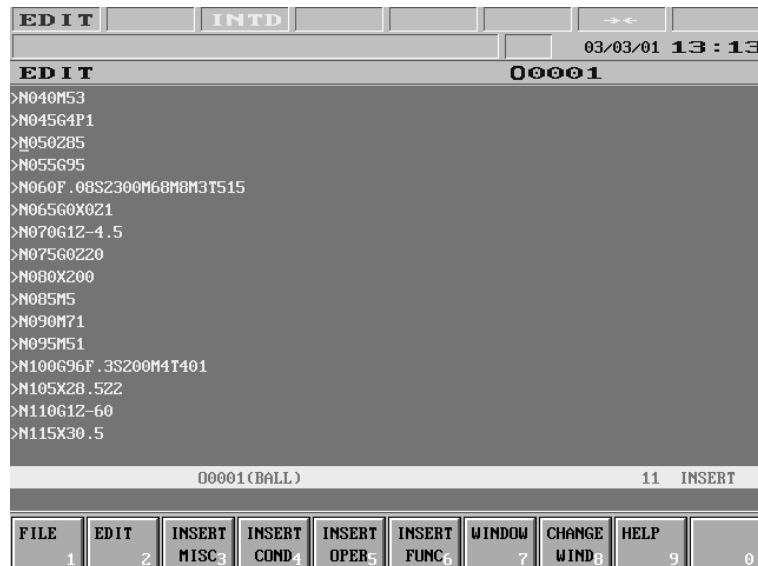

### 8.3 Manual Data Input Mode

Program execution in manual data input mode can only be done upon power-on state of the machine, i.e. when there is no **EMG** (emergency stop) state in the rightmost field (general NC state) of status bar.

If the machine is mounted with NCT machine control board the manual data input mode can be switched on by pressing the  button.

In manual data input mode all part programs in control memory, that is not selected for automatic execution can be executed. The program to be executed can be selected after displaying the **DIRECTORY** screen. After pressing the **action menu** key action menu **RUN** must be selected. Then the process corresponds to what have been discussed in chapter “Program directory actions”.

By opening the operation mode caption **MDI** appears in the leftmost field of status bar. The

program starts by the use of the **START** button, while with the **STOP** button the execution can be stopped. By pressing **START** button error message

**NOT EXISTING PROGRAM**

is displayed if no program is selected for execution in manual data input mode.

MDI	STRT	MOV	03/03/03 08:55						
<b>PROGRAM TEXT</b>		07001							
<b>ABSOLUTE</b>	<b>DIST. TO GO</b>	<b>END POS.</b>							
X 190.165	X- 108.165	X	82.000						
Z 183.831	Z- 177.831	Z	6.000						
F 0.0000	0.0000	100%	100%						
S 0	0	100%	G54						
>N100 G0 X200 Z200									
>N110 T101									
>N120 G0 X82 Z6									
>N130 G92 S3500									
>N140 G96 S150 F0.5 M3 M8									
>N150 G79 X-1 Z5									
>N160 Z3									
>N170 Z1									
>N180 Z0									
>N190 G0 X82 Z2									
>N200 G71 U1 R0.5									
>N210 G71 P230 Q310 U0.3 W0.3 F0.5									
TEXT	FUNCTI	LAST	ACTIVE	OPRTR	MESSAG				
1	ON 2	3	4	S PAN	E 6	7	8	9	0

#### Differences between Automatic and Manual Data Input modes

- In manual data input mode only programs in memory can be executed, therefore in this case DNC transfer is not possible!
- In manual data input mode the program cannot be continued from the interruption point (contrary to automatic mode). This means that the program is always executed from the beginning when the operation mode is activated.
- In program selected for manual data input mode block number cannot be searched for.

Among others the manual data input mode can be used for simplifying interventions frequently occurring while machining. In this case there is no need to enter and execute one or more blocks by means of single block input, but the process needed is written down in a program. Switching over from automatic to manual data input and starting the process by interrupting automatic mode can be done any time. For example in the case of tool break a program, which stops spindle and switches off coolant, takes out the tool and stands to a position the intervention from which is easy, can be started in manual data input mode. Another way to use it is when a size needs to be checked on the work during machining, the automatic mode can be interrupted and a measuring cycle started in manual data input mode. After the needed process is done the automatic mode can be returned and the machining continued.

In manual data input mode, during program execution, the operation of the following functions corresponds to that in automatic mode:

- Single block execution
- Conditional STOP
- Conditional block
- Dry run
- Locking possibilities.



## 9 Override Switches

The control can operate three override switches:

- the feedrate,
- the rapid traverse, and
- the spindle speed

override switches.

### 9.1 Feedrate Override Switch

The feedrate override switch has 16 positions. The feedrate switch determines, by how many percent of the programmed feedrate (F) should the axes be moved. The diagram beside shows the position of the switch and the percentage belonging to the position. *Position 0% stops the movement of not only the feed, but also of rapid traverse movements.*

In basic configuration feedrate override switch can be selected on OPERATOR'S PANEL or POSITION screen. After pressing the **action menu** key, action <sup>F4</sup> % must be selected. This way the percentage can be decreased (by means of softkey F-), as well as increased (by means of softkey F+).

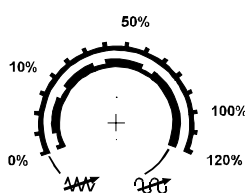

The NCT machine control board is mounted with a 16-position rotary switch. In this case in place of the above mentioned override adjustment with softkeys this feedrate switch can be used.

The feedrate switch position is interpreted in jog mode on the basis of parameter adjustment. If the value of parameter 1372 JOGFEED is 0, the speed of jog is the modal value F. If the value of parameter 1372 JOGFEED is 1, the control registers the speed fixed in table on the basis of feedrate switch position. (See table of jog mode.)

In the following cases the feedrate switch is ineffective:

- G63, i.e. state of override disabled,
- at the values of variable #3004 listed in programmer's manual, and
- during thread cutting G33, G34, G76, G78 and tapping cycles G84.1, G84.

In these cases the control always supposes 100% independent of switch position.

switch state	%
1	0
2	1
3	2
4	5
5	10
6	20
7	30
8	40
9	50
10	60
11	70
12	80
13	90
14	100
15	110
16	120

### 9.2 Rapid Traverse Override Switch

The rapid traverse override switch determines, by how many percent of the rapid traverse rate defined in the parameter should the axes be moved. The diagram beside contains the switch positions and the percentages belonging to the positions.

switch state	%
1	F0
2	25
3	50
4	100

F0 is a percentage fixed at parameter 1204 RAPOVER. Its practical value is 10% or less.

If the value of parameter 1204 RAPOVER is 0 the rapid traverse override values (depending on the PLC program) are the same discussed earlier at feedrate override in the range of 0, 1, 2, 5, 10, 20, ..., 100%. Consult with the machine tool builder on details.

*Feedrate override switch position 0% stops the rapid traverse movements as well, so there is no need to have a rapid traverse position 0%.*

In basic configuration, rapid traverse rate override switch can be selected on OPERATOR'S PANEL or POSITION screens. After pressing the **action menu** key, action <sup>F4</sup> % must be selected. This way with the help of softkeys R-, R+ the percentage can be decreased (by means of softkey R-), as well as increased (by means of softkey R+).

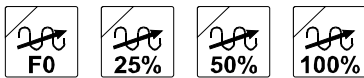

If the machine is mounted with NCT machine control board the **rapid traverse override** value can be selected with four buttons optionally.

*Note:*

*The control can also take over % value of rapid traverse rate from feedrate override switch. For details turn to the machine tool builder for an information material.*



### 9.3 Spindle Speed Override Switch

The spindle speed override switch has 11 positions. The switch determines, by how many percent of the programmed spindle revolution (S) should the spindle be rotated. The diagram beside contains the switch positions and the percentages belonging to the positions.

switch state	%
1	50
2	60
3	70
4	80
5	90
6	100
7	110
8	120
9	130
10	140

In basic configuration, spindle speed override switch can be selected on OPERATOR'S PANEL or POSITION screens. After pressing the **action menu** key, action <sup>F4</sup> % must be selected. This way with the help of softkeys S-, S+ the percentage can be decreased (by means of softkey S-), as well as increased (by means of softkey S+).

Three buttons are mounted on the NCT machine control board. In this case in place of the above mentioned override adjustment with softkeys

the three buttons can be used. With the button  in effect the value is decreased, while by pressing the button  it is increased. By





pressing the button  the control restores the programmed 100% rate.

During thread cutting G33, G34, G76, G78 and tapping cycles G84.1, G84 the spindle speed override switch is ineffective. The control registers 100% independent of the switch position.

## 10 Program Execution Start and Stop

The program execution is started by the use of the START  button.

The program execution can be stopped by means of the following functions and keys:

- with the STOP  button,
- with the RESET  key,
- at the end of block execution in the single block mode ,
- after executing programmed stop command **M00**,
- as the effect of conditional stop command **M01**, if optional stop switch  is on,
- after executing program end commands **M02**, **M30**.

### 10.1 Starting Program Execution

In the following cases the program execution is started by pressing START button :

- in jog, incremental jog or manual handle feed mode, after single block has been entered and terminated,
- in automatic mode, if program is selected for execution from memory or DNC,
- in manual data input mode, if program is selected for execution.

Error message

NOT EXISTING PROGRAM

is displayed by pressing START button, if no program is selected for execution. START state is indicated by caption **STRT** in the 3<sup>rd</sup> field of status bar.

### 10.2 Feed Stop

During program execution by pressing STOP button  START state is cancelled. The axes decelerate and stop. The execution of functions (M, S, T, B) in the given block is continued till the end of block. STOP state is indicated by caption **STOP** in the 3<sup>rd</sup> field of the status bar.

In the following cases the STOP button is ineffective:

- G63, i.e. state of override inhibit,
- values of variable #3004 listed in programmer's manual, and
- during thread cutting G33, G34 and tapping cycles G84.1, G84.

### 10.3 RESET

If reset key  is pressed during **program execution**, START or STOP state is canceled.

The axes decelerate and stop, even if control executes operation, where the use of feedrate override switches and STOP button is ineffective (e.g.: G33, G34, G76, G78, G84.1, G84).

At the same time some global messages are also cleared from the message field of the status bar.

The PLC program (generally) stops spindle rotation and suspends operation under execution. Besides RESET key has other effects in the different modes as well.

**In Automatic Operation in Case There is No INTD State Yet:** If RESET key is pressed in automatic operation and there is no INTD (interrupted) state yet, caption **INTD** is displayed in the 3<sup>rd</sup> field of status bar. This means, that automatic operation is interrupted. Afterwards program execution can be continued from the *block, which has been interrupted*.

**In Manual Data Input Mode:** If RESET key is pressed in manual data input mode, program execution is interrupted and *it cannot be restarted from the interruption point*, only from the beginning.

**In Case of the Execution of a Single Block:** If RESET key is pressed during the execution of a single block the block is cleared from the buffer. If the same block needs to be executed again, the single block input must be terminated once more.

In case **automatic mode** is being selected, **INTD state** is in effect, **no message** is being displayed in **global** message line and **RESET** key is pressed, INTD state is cancelled and the program executor goes to the first line of the program selected for automatic execution, i.e. machining begins from the beginning by pressing START button. INTD state is cleared and control registers default status fixed at parameters.

### 10.4 Programmed Stop: M00

If control goes to code M00 during program execution, it executes block containing code M00, than STOP state is assumed and the machining stops. With START  button the machining is continued.

### 10.5 Conditional Stop: M01

Conditional stop state can be selected on OPERATOR'S PANEL or POSITION screens. After pressing the **action menu**



 key <sup>F5</sup> CONDITIONS

action menu must be selected, than switch COND. STOP (conditional stop) needs to be pressed.

If NCT machine control board is used select  button.

If control runs to code M01 during program execution, it

AUTM	STOP	FIN	03/03/03 09:00						
PROGRAM TEXT			01000						
ABSOLUTE	DIST. TO GO	END POS.							
X 200.000	X 0.	X	200.000						
Z 210.000	Z 0.	Z	210.000						
F 300.0000	300.0000	100%	100%						
S 500	0	100%	G54						
> X200									
> M1									
> G1 Z20 F300									
> G0 X210									
> Z210									
> G0 X200									
> #100=#5001									
> M98 P1001 L7									
> M98 P1003									
> G0 X120									
> #100=#5001									
> M98 P1002 L4									
TEXT	FUNCTI	LAST	ACTIVE	OPRTR	MESSAG				
1	ON	2	3	S PAN:	E	6	7	8	9

executes block containing code M01 if switch COND. STOP  is on, than STOP state is assumed and the machining stops. With START button  the machining is continued. Nothing happens if switch COND. STOP  is off.

### 10.6 End of Program: M02, M30

Codes M02, M30 indicate the end of main program. By its use the machining stops, START state is canceled. In the course of program execution from memory listing goes to first block of main program, from where the machining can be started from the beginning by the use of START button .

Even if program end code is not entered to the end of main program, with symbol % in effect the above process is affected, except for PLC actions belonging to the codes M02, M30, for example spindle stop and coolant off are not executed.

## 11 Intervention in the Course of Program Execution

### 11.1 Conditional Block Skip

If at the beginning of block conditional block skip /n is programmed (n means the number of the conditional block switch), than

- if switch No. n is **on**, it **skips** block,
- if switch No. n is **off**, it **executes** block.

The conditional block switch No. 1 can be reached on OPERATOR'S PANEL or POSITION screens. After pressing the **action menu** key, <sup>F5</sup> CONDITIONS action menu must be selected, than switch COND. BLOCK (conditional block) needs to be pressed.

If NCT machine control board is used select  button.

The control can handle another 8 conditional block switches (altogether 9). These switches can be optionally used.

### 11.2 Increasing Feedrate by Means of Rapid Traverse Jog Button

If axes are moved during program execution and rapid traverse jog button  is pressed, the control increases feedrate, if rapid traverse jog button is released, it resets the programmed feedrate.

The measure of acceleration is determined by the value fixed at parameter 1371 FMULT. The programmed value is multiplied by the number fixed at parameter, and the result is activated as feedrate. If the value of parameter is 1 the feedrate remains unchanged when pressing rapid traverse button, if the value is e.g. 2 it is doubled.

AUTM	STRT	MOV	03/03/03 09:03						
PROGRAM TEXT			01000						
ABSOLUTE	DIST. TO GO	END POS.							
X 200.000	X 0.	X	200.000						
Z 204.072	Z- 184.072	Z	20.000						
F 300.0000	300.0000	100%	100%						
S 500	0	100%	654						
> X200									
> G1 Z20 F300									
>/1 G0 X210									
> Z210									
> G0 X200									
> #100=#5001									
> M98 P1001 L7									
> M98 P1003									
> G0 X120									
> #100=#5001									
> M98 P1002 L4									
> G40 X280 Z240 M5 M9									
TEXT	FUNCTI	LAST	ACTIVE	OPRTR'	MESSAG				
1	ON 2	3	4	S PAN.	E 6	7	8	9	0

### 11.3 Intervention by Means of Manual Handle in Automatic Operation

The manual handle operation can also be turned on parallel to the automatic operation. In this case in the leftmost field of status bar caption **AUTM** or **AUTD** indicating automatic operation can be seen, depending on where the program execution takes place from. At the same time in the 2<sup>nd</sup> field of status bar caption **HNDL** appears, indicating the manual handle operation. By the use of the manual handle a movement can be overlapped to the movement of axes defined in the program. The tool path formed will differ from the one defined in the program.

AUTM		HNDL		STRT		1				03/03/03 09:06					
PROGRAM TEXT						01000									
ABSOLUTE			DIST. TO GO			END POS.									
X	200.000	X	0.	X	200.000	Z	27.072	Z-	7.072	Z	20.000				
F	300.0000		300.0000	100%	100%	S	500		0	100%	G54				
> X200 > G1 Z20 F300 > /1 G0 X210 > Z210 > G0 X200 > #100=#5001 > M98 P1001 L7 > M98 P1003 > G0 X120 > #100=#5001 > M98 P1002 L4 > G40 X280 Z240 M5 M9															
TEXT	1	FUNCTI	2	LAST	3	ACTIVE	4	OPRTR	5	MESSAG	6	7	8	9	0

*The rules of operation are as follows:*

- The rules of selecting axis and increment correspond to the ones discussed by manual handle mode.
- The speed of intervention coming from the manual handle is added algebraically to the speed resulting from interpolation, however the speed realized cannot be over the maximum feedrate permitted, that is registered on the given axis.  
 If e.g. the maximum feedrate is 2000 mm/min and the selected axis is moved in direction + by 400 mm/min, the speed coming from manual handle can be 1600 mm/min in direction +, or 2400 mm/min in direction -.  
 If the speed realized is over the maximum speed permitted, the control *throws away the useless pulses*, in contrast to the normal manual handle mode.
- Movement is made even in feedrate override state 0%.
- As the effect of intervention by means of manual handle the direction can be reversed.
- Movement is not made in the following cases:  
 State G00, or other states of rapid traverse movement, as, e.g., positioning phase of canned cycle, G28, G53, etc. even if no movement command is programmed on the given axis.  
 STOP state.



Effect of intervention to coordinate system

- The manual handle pulses are also added to the offset on the appropriate axis in the common work zero point offset registers. This way all the works and local coordinate systems are being shifted.
- Naturally this does not influence the machine coordinate system. In case of G53 or G28 the axis always moves to the appropriate position.

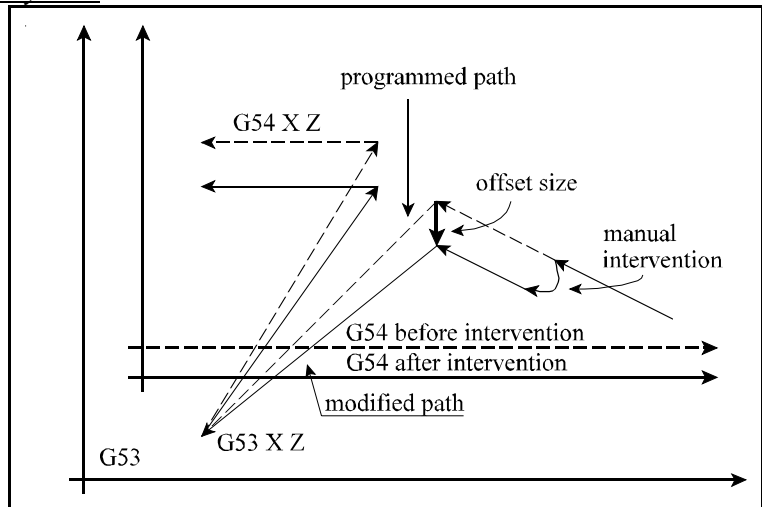

- The value rotated by manual handle cannot be seen on the display showing the current position in compliance with the above discussed.

If one of the common work zero point offsets is other than zero an exclamation mark ! can be seen in the 7th status field.

## 12 Debugging the Part Program

The following functions help the testing, debugging of the part program:

- single block execution,
- dry run,
- locking possibilities and
- test run.

These functions are not operation modes, but conditions influencing the program execution in automatic mode.

### 12.1 Single Block Execution

Single block execution can be selected on OPERATOR'S PANEL or POSITION screens. After pressing the **action menu** key, <sup>F5</sup> CONDITIONS action menu must be selected, than softkey SINGLE BLOCK needs to be pressed.

If NCT machine control board is used select the  button.

Single block execution can be done in automatic and manual data input modes. The control stops (STOP state) after the execution of each block.

An exception to that when thread cutting blocks G33 follow each other or suppression of single block execution has been programmed by giving value #3003=1. The machining continues with the START button .



### 12.2 Dry Run (All Feedrates at High Speed)

Switch DRY RUN can be reached on OPERATOR'S PANEL or POSITION screens. After pressing the **action menu** key, <sup>F5</sup> CONDITIONS action menu must be selected, than softkey DRY RUN needs to be pressed.

If NCT machine control board is used select the  button.

When the switch is on all feeds move at high speed, fixed at parameter. It executes every movement at feedrate interpreted in dimension per minute, independent of whether state G94 or G95 is programmed .

*Generally the DRY RUN button  can be activated only in one of the manual modes provided the axes are in stopped state. For details turn to the machine tool builder for an information material.*

### 12.3 Machine Lock Function

Switch MACHINE LOCK can be reached on OPERATOR'S PANEL or POSITION screens. After pressing the **action menu**

key  F5 CONDITIONS

action menu must be selected, than softkey MACHINE LOCK needs to be pressed.

If NCT machine control board is used select the  button.

The locked state of the machine is indicated by caption **LOCK** in the 8<sup>th</sup> field (general NC state) of the status bar.

If the switch is on:

- the interpolator does not give out any command to the position control loop on either axis, as well as
- no function is executed by the PLC at all.

Functions machine lock and dry run can be combined, i.e., both can be switched on at the same time. The POSITION screen and the GRAPHIC POSITION screen show the path already drawn. If switch dry run is on, the speed is high, if it is off, the speed is the programmed feedrate.

If machine lock is switched off, the momentary axis positions can be seen again on the POSITION screen of control.

*Note:*

Generally key MACHINE LOCK  can be switched in one of the manual modes in case the axes are in STOP state For more turn to the machine tool builder for an information material.

### 12.4 Other Locking Possibilities

Other locking possibilities may be at disposal optionally. These are as follows:

#### Function Lock

This means, that the control does not execute any function sent to PLC (M, S, T, B ect.)

If NCT machine control board is used select the  button.

#### Axis Lock

The axes can be locked separately. In this case the locked axis (axes) does (do) not move, while the others do.

AUTM	STRT	DRUN	LOCK
			03/03/03 09:10
PROGRAM TEXT		01000	
ABSOLUTE	DIST. TO GO	END POS.	
X 190.000	X 0.	X 190.000	
Z 94.736	Z 115.265	Z 210.000	
F 300.0000	300.0000	100%	100%
S 500	0	100%	G54
> #100=#100-10			
> GO X#100			
> G1 Z20			
> G2 X200 Z80 I100 K120 R40 Q1			
> GO X[#100+10] Z210 ,A0 Q-1			
> M99			
>:			
TEXT	FUNCTI	LAST	ACTIVE
1	ON 2	3	4
	OPRTR'	MESSAG	
	S PAN	E 6	

The different function and axis locking possibilities can be combined optionally. An axis, e.g. Z axis and the functions can be locked simultaneously.

*Note:*

About the different locking possibilities turn to the machine tool builder for an information material.

### 12.5 Test Run

Softkey TEST can be reached on OPERATOR'S PANEL or POSITION screens. After pressing the **action menu** key  F5 CONDITIONS action menu must be selected, than softkey TEST needs to be pressed.

If NCT machine control board is used select the  button.

The TEST state is indicated by caption TEST in the 8<sup>th</sup> field of the status bar.

When the key is activated:

- the interpolator does not command any movement on any axis towards the position control loop, and
- no function is executed by the PLC.

The TEST state can be applied for the syntactic and graphic test of programs. The program execution (the interpolation) is much faster than it is in case of the simultaneous switched on state of MACH LOCK and DRY RUN. The position display and the graphic position display show the path done.

AUTM		STRT							TEST
					03/03/03 09:13				
PROGRAM TEXT					01000				
ABSOLUTE		DIST. TO GO		END POS.					
X	180.000	X	0.	X	180.000				
Z	210.000	Z	0.	Z	210.000				
F	300.0000	300.0000	100%	100%					
S	500	0	100%	G54					
> #100=#100-10									
> G0 X#100									
> G1 Z20									
> G2 X200 Z80 I100 K120 R40 Q1									
> G0 XI#100+101 Z210 ,A0 Q-1									
> M99									
>>									
TEXT	FUNCTI	LAST	ACTIOE	OPRTR	MESSAG				
1	ON 2	3	4	S PAN5	E 6	7	8	9	0

If  button TEST is

inactivated, than the current axis positions can be seen again in the position display of control.

*Note:*

Generally the TEST  button can be switched in one of the manual modes in case the axes are in stopped state. For more turn to the machine tool builder for an information material.

## 13 Interruption and Restart of Automatic Operation

In many cases the automatic operation needs to be interrupted, than later on the machining to be continued. Cases like this for example when:

- the errors must be repaired, than the machining continued when error messages are coming from program module preprocessor or PLC,
- during machining the program may need to be corrected, for example because of syntactical error,
- in case of tool break the broken tool must be retracted and replaced, than the machining continued with the a new tool and - if necessary - new offset values,
- in some phases of machining the result needs to be examined, checked, than the machining continued,
- if in course of the machining an obstacle, for example workpiece clamping is in the way of tool path it needs to be rounded, than the machining continued,
- if work has to be paused, for example in case of power breakdown, than continued from the interruption point.

The above cases require different types of intervention by the operator. The above problems must be repaired by means of services of the control discussed here.

### 13.1 Interruption of Automatic Operation



In the course of automatic operation the following interventions cause interrupted state:

- appearance of emergency stop state, e.g. by pressing the EMERGENCY STOP button,
- effect of the RESET key  or
- changing the operation mode

The interrupted state is indicated by caption **INTD** in the 3<sup>rd</sup> field of status bar. In interrupted state lots of manual interventions can be done on the control, which can be registered or canceled when restarting.

### 13.2 Restart of the Automatic Operation. Modal Information.

The automatic operation can be restarted in three ways in **INTD** state:

- unconditionally,
- by means of the condition BLOCK RESTART  or
- by means of the condition BLOCK RETURN .

The difference among the three restart methods is that while in the first case if movement from interruption point has been made it goes to the block end position, in the second case it goes to the start position of the interrupted block and re-executes the whole block, and in the third case it moves back to interruption position and continues machining from there.

In the interrupted (INTD) state of automatic operation the modal information changes by entering a single block or running the program selected for manual data input mode. Therefore

if machining is started in INTD state of automatic mode and START button is pressed, control registers STOP state and message

RESTORE MODAL FUNCTIONS? Y

is displayed (Y=yes). By pressing <SHIFT>  key question

RESTORE MODAL FUNCTIONS? N

is asked (N=no). The messages can be switched over by the use of <SHIFT> key . If the

START  button is pressed, it restores the state before suspension according to the

message (Y) or not (N). The message is canceled with the help of the RESET key  and

INTD state remains.

Modal information restated or not restated:

- modal G codes,
- value F,
- compensation code: T\_\_nn,
- modal parameters of canned cycles (start level, R level ect).

After restart has been made from INTD state the work zero point offsets and tool compensation values altered always taken into consideration.

### 13.3 Unconditional Restart of Automatic Operation

If automatic operation is started from interrupted state (INTD) unconditionally after START



the control goes to the end position of the interrupted block and carries on machining from there. The typical applications of the function are as follows:

- the errors must be canceled, than the machining continued when error messages are coming from program module preprocessor or PLC,
- during machining parameters of cutting may need to be repaired, for example if spindle speed (S) or feedrate (F) must be overwritten by means of manual data input, than the machining continued,
- in more simple cases the end position or measure data is to be modified without repairing the part program,
- if in course of the machining an obstacle, for example a workpiece clamp is in the way of tool path it needs to be rounded, than the cutting continued.

#### Interrupting Single Blocks

*1<sup>st</sup> case: in state G40 interruption of linear interpolation parallel to an axis*

Let us examine fragments of the following sample programs:

Program No. 1:

```
...
N60 G90 G0 X20 Z0
N70 X120
N80 Z-30
...
```

Program No. 2:

```
...
N60 G90 G0 X20 Z0
N70 G91 X100
N80 Z-30
...
```

Programs No. 1 and 2 are on the same tool path, however the data specification of the former one is absolute, while that of the latter one is incremental. The interruption occurs in block N70. In position X=60, Z=0 the movement is stopped, the automatic mode is interrupted and the slides are carried to position X=80, Z=20 by means of manual operation. If afterwards the automatic mode is returned, and the START button is pressed the movement programmed in block N70 is finished. X axis moves to the programmed position X=120, no matter if the tool path has been written by the use of absolute data specification (program No. 1) or incremental data specification (program No.2). The Z axis does not move in block N70, it only returns to the programmed original tool path in block N80, where movement Z is programmed. In case Z axis is not referred to in more subsequent blocks it only returns to the programmed path in the block, in which reference to address Z takes place.

The movement is the same, if in single block mode the automatic operation is closed in the start position of block N70, manual operation is used, than after return the START button is pressed.

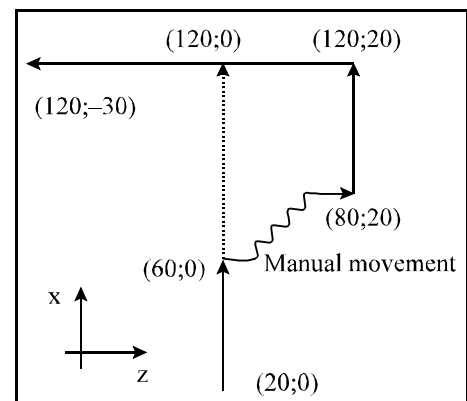

*2<sup>nd</sup> case: in state G40 interrupting oblique linear interpolation*

Let us examine fragments of the following sample programs:

Program No. 1:

```
...
N40 G90 G0 X20 Z-10
N50 X80 Z-60
N60 Z-85
...
```

Program No. 2:

```
...
N40 G90 G0 X20 Z-10
N50 G91 X60 Z-50
N60 Z-25
...
```

Programs No. 1 and 2 are on the same tool path, however the data specification of the former one is absolute, while that of the latter one is incremental. The interruption occurs in block N50. In position X=44, Z=-30 the movement is stopped, the automatic mode is interrupted and the axes are carried to position X=110, Z=-30 by means of manual operation. If afterwards the automatic mode is returned, and the START button is

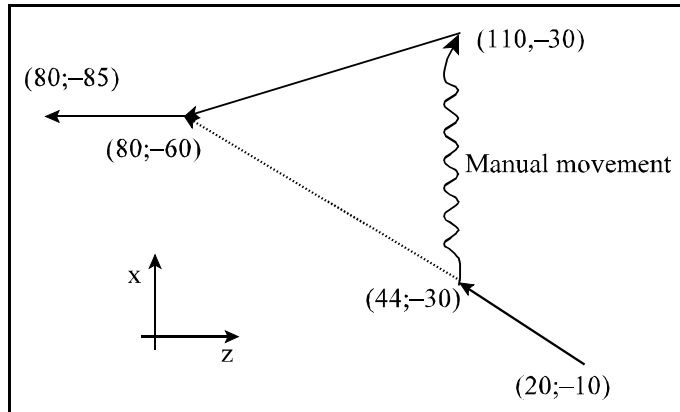

pressed the movement programmed in block N50 is finished. Axes X and Z move along oblique straight from their momentary state to the position X=80, Z=-60 programmed, no matter if the tool path has been written by the use of absolute data specification (program No. 1) or incremental data specification (program No.2).

The movement is the same, if in single block mode the automatic mode is closed in the start position of block N50, manual operation is used, than after return the START button is pressed.

**Interrupting Canned Cycles**

Let us examine the following cycle:

```
...
G17 G90 G81 X100 Y70 Z-60 R2 F200
...
```

In the view of interruption the canned cycle consists of 3 part blocks:

1<sup>st</sup> part block: Positioning in the selected plane. This block is referred to by control in the view of interruption where only one or two coordinates (in the example X and Y) have been programmed: G0 X100 Y70

2<sup>nd</sup> part block: Positioning on point R. This part block is in the view of interruption a positioning along an axis. In the example it is the axis Z moving to the value specified at address R: G0 Z2

3<sup>rd</sup> part block: Hole machining and retraction to initial position (G98) or to R-point (G99). In this case the end position of the part block is the initial position or R-point.

At the end of all three part blocks the control stops in single block mode.

*3<sup>rd</sup> case: Interrupting canned cycle in the course of positioning in the selected plane*

If the movement is interrupted while moving to position X=100, Y=70 in the sample block, than manual operation is used, after returning to automatic mode and pressing START button movement is made as in the 2<sup>nd</sup> case, i.e., axes move to position X100 Y70.



If in the selected plane the address of one of the axes has not been programmed (e.g., Y) and movement has been made also in this direction, or in Z direction, the movement may be led back to the 1<sup>st</sup> case, i.e., the axes will move after pressing START in neither Y, nor Z direction.

*4<sup>th</sup> case: Interrupting canned cycle in the course of positioning to R*

If in the above example the movement is interrupted in the course of positioning to the coordinate in Z direction to R=2 and manual operation is used, after returning to automatic mode and pressing the START button the axis moves to the position in Z direction to R=2 as in the 1<sup>st</sup> case.

If in the course of manual operation movements were also made in the plane X, Y after returning to automatic mode and pressing the START button, no return in direction X, Y occurs. This way the X, Y coordinate of the hole can be modified by the operator by means of manual intervention even during machining.

*5<sup>th</sup> case: Interrupting canned cycle in the course of hole machining*

If a canned cycle has been interrupted in the course of hole machining, by restarting with the help of the START button it moves to initial level in state G98 or to level R in state G99. Afterwards it continues machining by executing the forthcoming block. If also a repetition count has been programmed in the cycle and it was not the last hole machining interrupted, after returning to initial level or level R it continues machining by positioning above the next hole.

Considering the above-mentioned facts there are two ways to interrupt hole machining.

If while retracting the operator notices, that, e.g., in case of a through hole, the programmed hole length is too short, STOP is pressed, any of the manual modes are opened and the operation is executed by means of manual operation. After returning to automatic operation and pressing the START button the control retracts the tool and continues the machining.

If the operator stops the drilling even before reaching the bottom point and retracts the tool in manual mode, then returns to automatic operation, after pressing the START button the tool moves to either initial level or level R and the machining is continued from there. By means of this intervention the depth of the hole can be corrected.

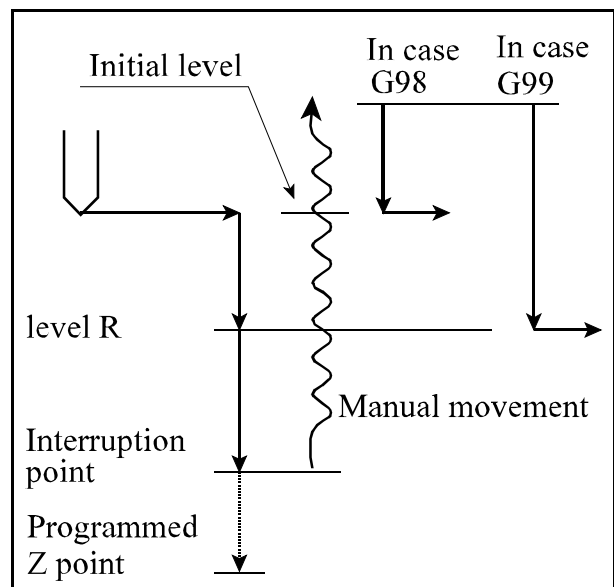
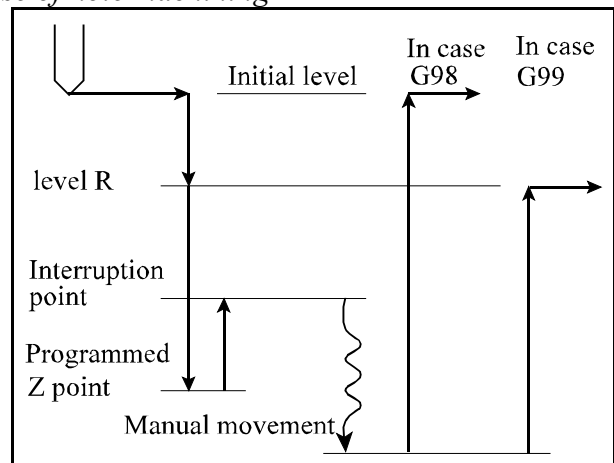

### Interrupting Machining in Offset Mode

The cases below refer to the axes in the selected plane in when offset mode is on. To interruption of axis movements outside the selected plane refer to interruption cases in state G40.

6<sup>th</sup> case: in state G41 or G42 interrupting linear interpolation parallel to axis

Let us examine fragments of the following sample programs:

Program No. 1:

```
G41 G18 G90 G1...
...
N80 X40
N90 Z-30
...
```

Program No. 2:

```
G41 G18 G91 G1...
...
N80 X45
N90 Z-20
...
```

Both programs are on the same tool path, however the data specification of the former one is absolute, while that of the latter one is incremental. If the machining is interrupted in position X=20, Z=-10 the automatic mode is closed and manual operation is used, than after returning to automatic mode the START button is pressed both axes taking part in the contour tracking move to the programmed end position as seen on the diagram, independently of the tool path having programmed by the use of absolute data specification or incremental data specification. If in the above example yet another axis is moved by means of manual operation, after pressing the START, no movement occurs on that axis, as discussed in the 1<sup>st</sup> case. If in single block mode the automatic execution is interrupted in STOP state at the beginning of block N80, after return and START, the tool path is recalculated as discussed above. If in the meanwhile the value of the tool radius has been changed, it carries on cutting by taking the new offset value into account.

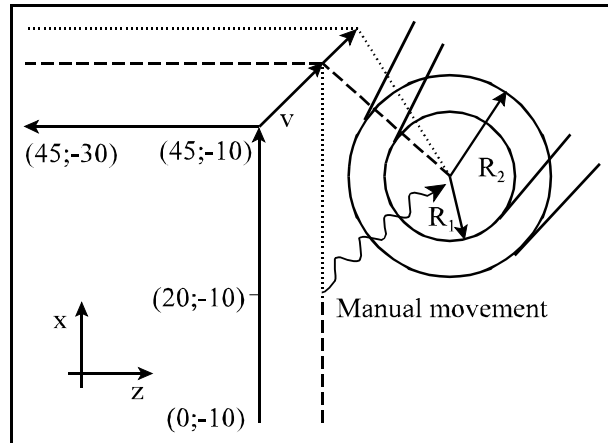

7<sup>th</sup> case: in state G41 or G42 interrupting oblique linear interpolation

If during contour tracking the automatic operation is interrupted in the course of oblique linear interpolation after return and START, the tool path is recalculated as discussed in the 6<sup>th</sup> case.

8<sup>th</sup> case: in state G41 or G42 interrupting circular interpolation

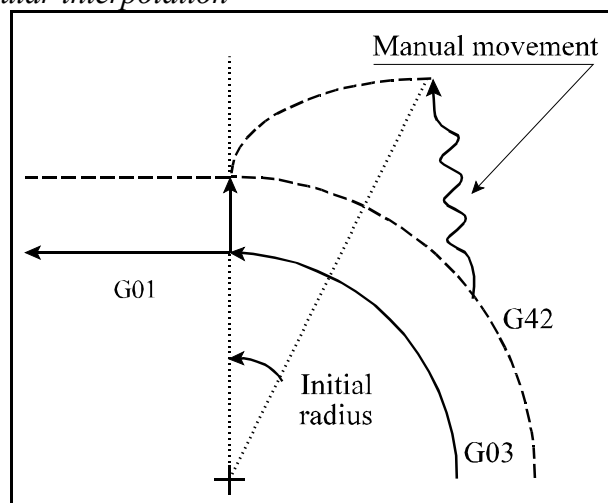

If in offset mode the automatic operation is closed in the course of circular interpolation after return to automatic mode and pressing the START button the tool approaches the end position programmed in the block along a circle with a variable radius. The center of the circle corresponds to the center of the programmed one. Its starting radius equals to the distance between the center of the circle and the momentary tool position. The end point radius of the circle corresponds to the programmed one.

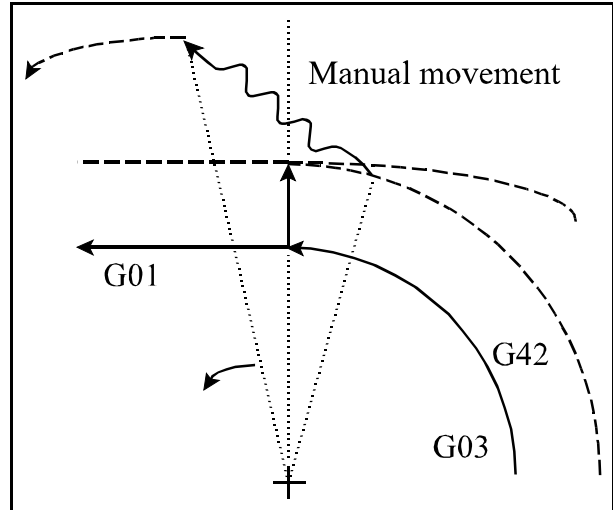

When manual movement is done to a position, which is left from the end position of the circle, according to the diagram, the control proceeds also as discussed above. However this time the arc of the variable radius circle is close to  $360^\circ$  because of direction G03 according to the diagram.





### 13.4 Automatic Operation Restart with BLOCK RESTART Condition

If the condition BLOCK RESTART  is switched on after returning to automatic mode and than START button  is pressed, the control goes to the start position of the interrupted block and continues machining from there, i.e., it re-executes the interrupted block. This function is typically for the restart after tool break. After tool replacement the work zero point offset values and/or tool compensation values can be changed. When pressing START button it goes to the start position of the interrupted block with the new work and tool offset values.

Its switch can be selected on OPERATOR'S PANEL or POSITION screens. After pressing the action menu key, <sup>F5</sup> CONDITIONS must be selected, than <sup>F5</sup> BLOCK RESTART softkey pressed. Afterwards the block execution is carried on according to the cases below.

If NCT machine control board is used select the  button.

#### 13.4.1 Return to the Block Start Position by Means of Manual Operation

In the interrupted state (INTD) of automatic operation BLOCK RESTART  condition can be switched on in any manual operation mode (Jog, Incremental jog, Manual handle feed). After it is switched on the distance needed for return can be seen on the distance to go display for each axis. The axes can be moved continuously in any (+/-) direction to the position, where the distance to go is 0. The axis moved decelerates and stops automatically on the return position. Afterwards the axis cannot be moved any more from this position, only if BLOCK RESTART  condition is switched off.

There is no need to move fully to the return position, but by switching over to automatic mode and pressing START  the return process can be continued. With the help of this function return to start position can be made in the desired way, thereby avoiding the possible obstacles.

#### 13.4.2 Return to Block Start Position in Automatic Mode

In automatic mode in case BLOCK RESTART  condition is on by the use of the START button it returns to start position of the block by linear interpolation. If an obstacle is in the way of the return, the movement can be broken with the help of STOP button. Afterwards the return can also be continued by means of a manual mode.

### 13.4.3 Cases of Return by Means of BLOCK RESTART Condition

#### Return to Block Start Position After Interrupting Simple Movement Block

*1<sup>st</sup> case: in state G40 interrupting and restarting linear interpolation*

The diagram shows the case, when a linear interpolation in the plane X, Z is interrupted, a manual mode is set and manual operation is used along the two axes. If after the automatic mode has been returned and BLOCK

RESTART  condition has been switched on START button is pressed or manual operation is used in one of the manual

modes, the control goes to the start position of the block interrupted.

**In the return process all axes take part**, even those not programmed in the interrupted block.

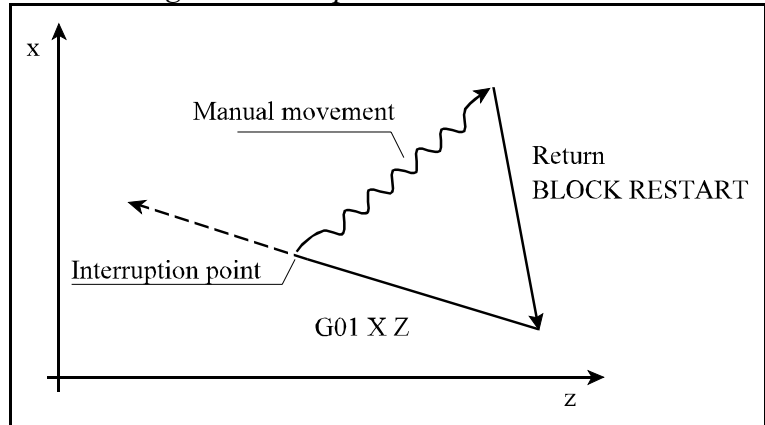

If on an axis the compensation is modified, as for example along X axis on the diagram beside, or the work zero point offset is changed it returns to X position valid in start position of the block registering the new compensation or offset.

(On the diagram it is supposed, that no movement is programmed in X direction in the interrupted block.)

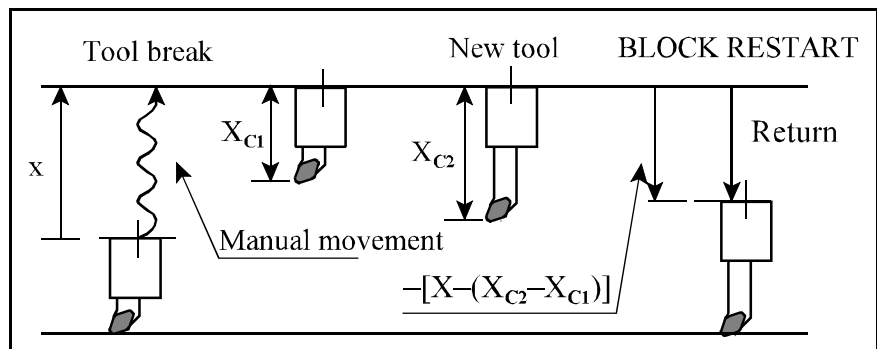

#### Return to Block Start Position After Interrupting Canned Cycles

Let us examine the following canned cycle:

```
...
G0 X50 Y20 Z10
G17 G90 G81 X100 Y70 Z-60 R2 F200
...
```

...

the canned cycle restarted by means of BLOCK RESTART  condition consists of 3 part

blocks:

1<sup>st</sup> part block: Positioning in the selected plane. In this part block the start position is coordinate X=50, Y=20, Z=10.

2<sup>nd</sup> part block: Positioning to R point. In this part block the start position is coordinate

$X=100, Y=70, Z=10.$

3<sup>rd</sup> part block: Hole machining and retraction to start position (G98) or to R-point (G99). In this part block the start position is coordinate  $X=100, Y=70, Z=2.$

At the end of all three part blocks the control stops in single block mode. If the canned cycle is programmed with repetition count L the above part blocks are repeated.

*2<sup>nd</sup> case: Interrupting and restarting canned cycle in the course of positioning in the selected plane*

If in the sample cycle the movement is interrupted during moving to position  $X=100, Y=70$  and it is moved to the start position of the block by means of the BLOCK RESTART 

condition (to coordinate  $X=50, Y=20, Z=10$  in the above example) the movement may be led back to the 1<sup>st</sup> case.

*3<sup>rd</sup> case: Interrupting and restarting canned cycle in the course of positioning to point R*

If in the sample cycle the movement is interrupted during positioning to point  $R=2$  along axis Z and it is moved to the start position of the block by means of BLOCK RESTART 

condition (to coordinate  $X=100, Y=70, Z=10$  in the above example) the movement may also be led back to the 1<sup>st</sup> case.

*4<sup>th</sup> case: Interrupting and restarting canned cycle in the course of hole machining*

If the canned cycle is interrupted during hole machining and it is moved to the start position of the block by means of BLOCK RE-

START  condition (to coordinate  $X=100, Y=70, Z=2$  in the above example) after pressing the START button it re-executes the hole machining and retraction.

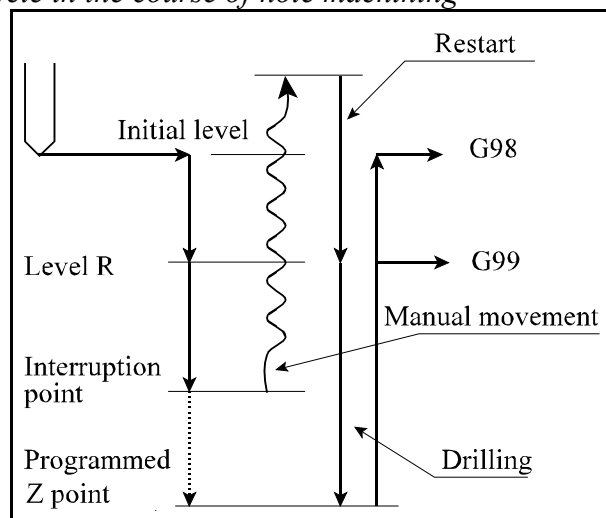

### Return to Block Start Position after Interrupting Machining in Offset mode

The following cases refer to axes in the selected plane, when the offset mode is on. For interrupting and restarting axis movements outside the selected plane the cases of state G40 can be applied.

5<sup>th</sup> case: Return to block start position after interrupting machining in offset mode at outside corner

By the use of BLOCK RESTART  condition it is set out from the offset vector on the start position of the interrupted block, the length of which is multiplied by the length of the new tool radius and divided by the old one:

$$L_2 = L_1 \cdot \frac{R_2}{R_1}$$

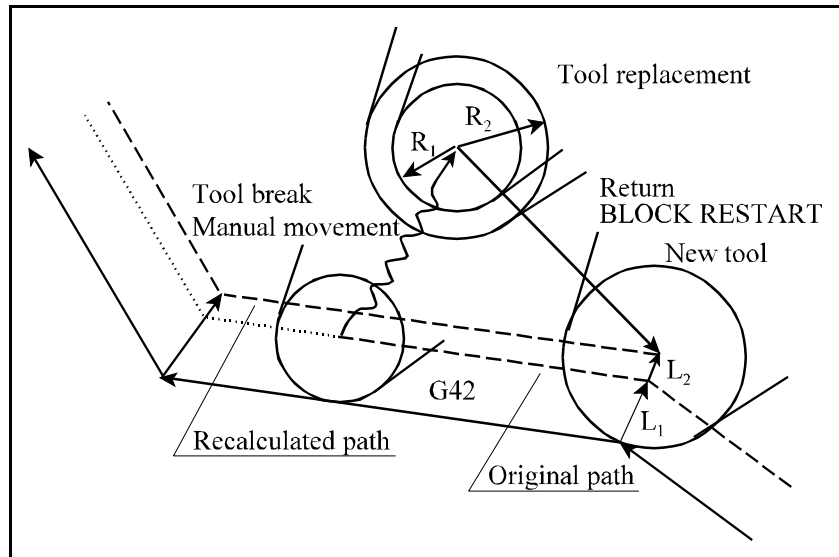

Afterwards the machining is continued on the tool path with the new offset value.

When returning to start position of the block the control also returns all axes.

6<sup>th</sup> case: Return to block start position after interrupting machining in offset mode at inside corner

When the BLOCK RESTART  condition is on, machining inside a corner corresponds to that of outside a corner. However this time, as seen on the diagram, if one of the blocks is a circle, it cuts into the workpiece. This can be surmounted if the tool is not returned fully to the start position, but is stopped earlier and

BLOCK RESTART  condition is switched off.

From than on it corresponds to the process discussed in the chapter “Unconditional Restart of Automatic Mode”.

Another possibility is to start a block search for the interrupted block, however this is the province of another chapter.

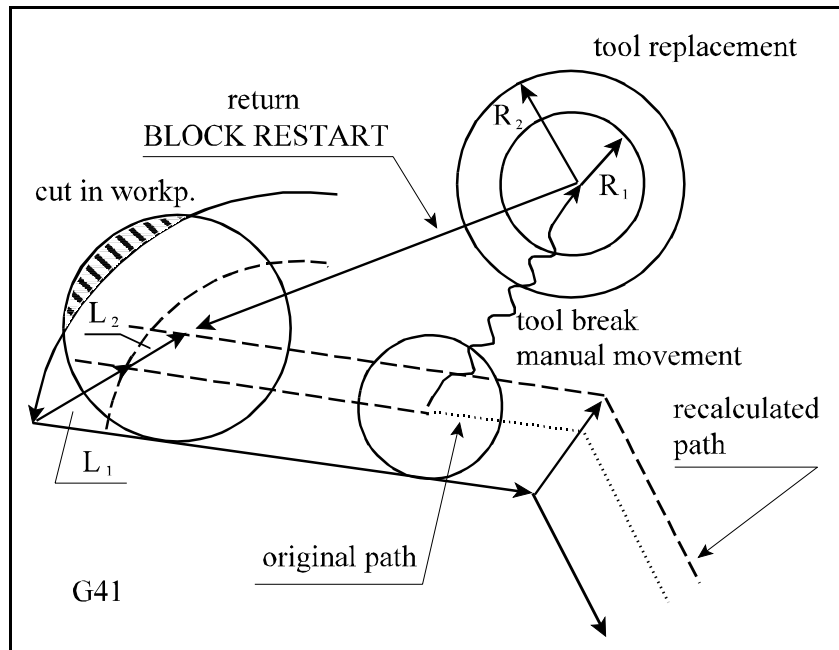

### 13.5 Automatic Mode Restart with BLOCK RETURN Condition

If automatic operation has been interrupted, manual operation was used to move away from the workpiece and return is to be made to the interruption point, the BLOCK RETURN condition needs to be used.

Its switch can be selected on the OPERATOR'S PANEL or POSITION screens. After pressing the **action menu** key action <sup>F5</sup> CONDITIONS must be selected and the BLOCK RETURN softkey pressed.

If NCT machine control board is used select the  button.

The control calculates the return position by taking the possible changes of work zero point offset values and tool offset values into account. In the general displaying area indicating the distance to go position the difference between the return position and momentary position appears.



Afterwards the return can be made by means of manual operation or automatically in automatic mode.

#### 13.5.1 Return to the Interruption Point by Means of Manual Operation

In the interrupted (INTD) state of automatic operation the BLOCK RETURN  condition can be switched on in any manual operation mode (Jog, Incremental jog, Manual handle feed). When the condition is on the distance needed for return, is shown on the distance to go display for each axis. The axes can be moved continuously in any (+/-) direction to the position, where the distance to go is 0. The axis moved decelerates and stops automatically on the return position. Afterwards the axis cannot be moved any more from this position, only if the BLOCK RETURN condition is switched off.



There is no need to move fully to the return position, but by switching over to automatic mode and pressing the START  the return process can be continued. With the help of this function return to start position can be made in the desired way, thereby avoiding the possible obstacles.

#### 13.5.2 Return to the Interruption Point in Automatic Operation

In automatic mode in case the BLOCK RETURN  condition is on by the use of the START  button it returns to the start position of the block by linear interpolation. If an obstacle is in the way of return, the movement can be interrupted with the help of the STOP  button. Afterwards the return can also be continued by means of a manual mode.





### 13.5.3 Cases of Return by Means of Condition BLOCK RETURN

Cases of return by means of BLOCK RETURN  condition correspond to that of BLOCK RESTART  condition, except for return is made not to start position of block, but to the interruption point.

#### Return to Interruption Point after Interrupting Simple Movement Block

*1<sup>st</sup> case: in state G40 interrupting and restarting linear interpolation*

The diagram shows the case, when a linear interpolation in the plane X, Z is interrupted, a manual mode is set and manual operation is used along the two axes. If after all the automatic mode is returned and after switching the BLOCK RETURN

 condition on the START button is pressed or manual operation is used in one of the manual modes when the BLOCK RETURN  condition is on,

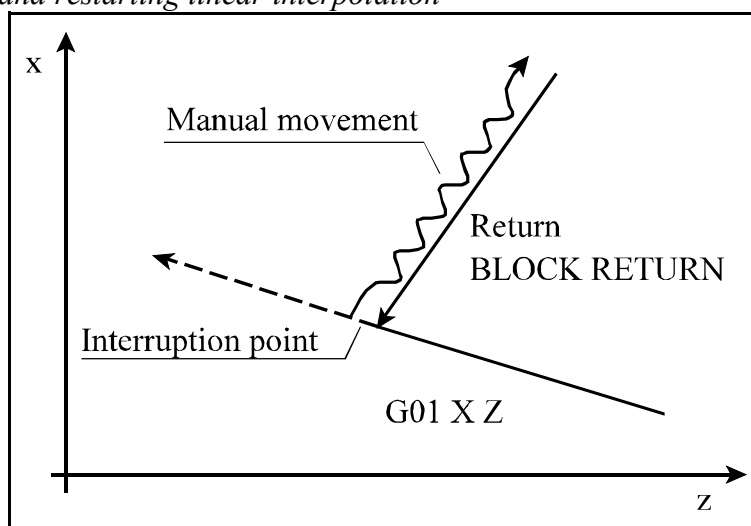

the control goes to the interruption point of the block.

**In the return process all axes take part**, even those not programmed in the interrupted block.

If on an axis the compensation is modified, as for example along axis X on the diagram beside, or a work zero point offset is changed it returns to X position valid on the interruption point of the block registering the new compensation or offset.

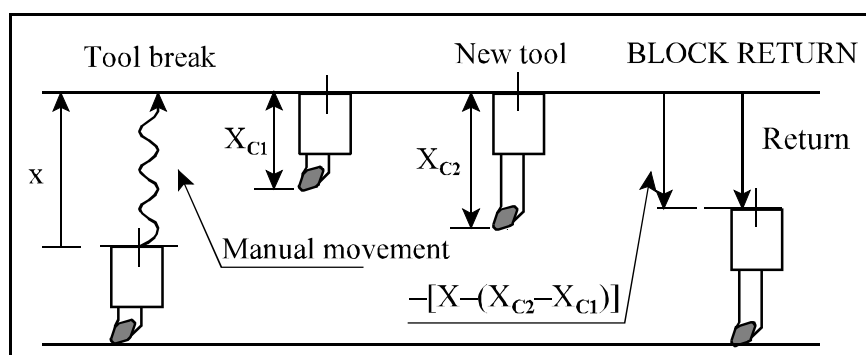

#### Return to Interruption Point after Interrupting Canned Cycles

Let us examine the following canned cycle:

...  
G17 G90 G81 X100 Y70 Z-60 R2 F200  
...

the canned cycle restarted by means of condition BLOCK RETURN  consists of 3 part blocks:

1<sup>st</sup> part block: Positioning in the selected plane (GO X100 Y70)

2<sup>nd</sup> part block: Positioning to point R (G0 Z2)

3<sup>rd</sup> part block: Hole machining and retracting to initial level (G98) or to point R (G99).

At the end of all three part blocks the control stops in single block mode. If the canned cycle is programmed with repetition count L the above part blocks are repeated.

*2<sup>nd</sup> case: Interrupting canned cycle and return in the course of positioning in the selected plane*

If in the sample cycle the movement is interrupted during moving to position X=100, Y=70 and the interruption point is moved by means of the BLOCK RETURN  condition the movement may be led back to the 1<sup>st</sup> case, i.e., all axes move to the position valid when the interruption takes place.

*3<sup>rd</sup> case: Interrupting canned cycle and return in the course of positioning to point R*

If in the sample cycle the movement is interrupted during positioning to point R=2 in direction Z and the interruption point is moved by means of BLOCK RETURN  condition the movement may also be led back to the 1<sup>st</sup> case.

*4<sup>th</sup> case: Interrupting and restarting canned cycle in the course of drilling*

If the canned cycle is interrupted during hole machining and the process is restarted by means of condition BLOCK RETURN  the movement may also be led back to the 1<sup>st</sup> case.

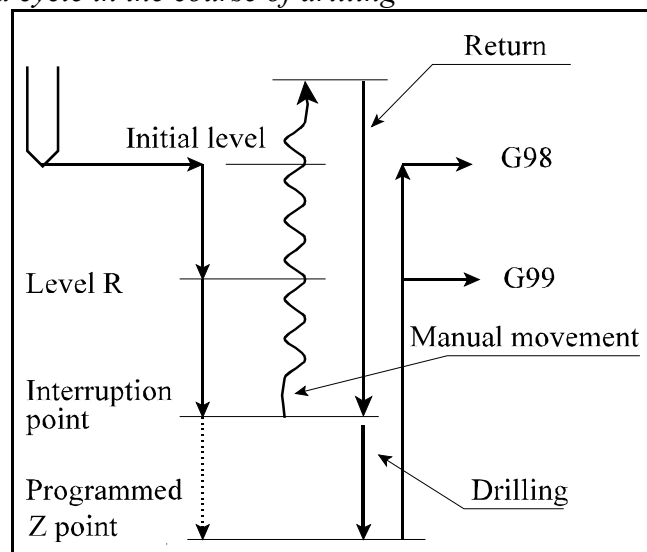

### Return to Interruption Point after Interrupting Machining in Offset Mode

The following cases refer to axes in the selected plane, when offset mode is on. For interrupting and return axis movements outside the selected plane the cases of state G40 can be applied.

*5<sup>th</sup> case: Return to interruption point machining in offset mode at outside corner*

By the use of the BLOCK RETURN  condition

it states a perpendicular vector on the interruption point, the length of which corresponds to that of the new tool radius (supposing the radius has been changed) Afterwards the machining is continued on the tool path with the new offset value from the interruption point.

When returning to interruption point of the block, the control also returns on the other axes. If tool length was also modified after tool replacement, it takes the new tool length into account (see 1<sup>st</sup> case).

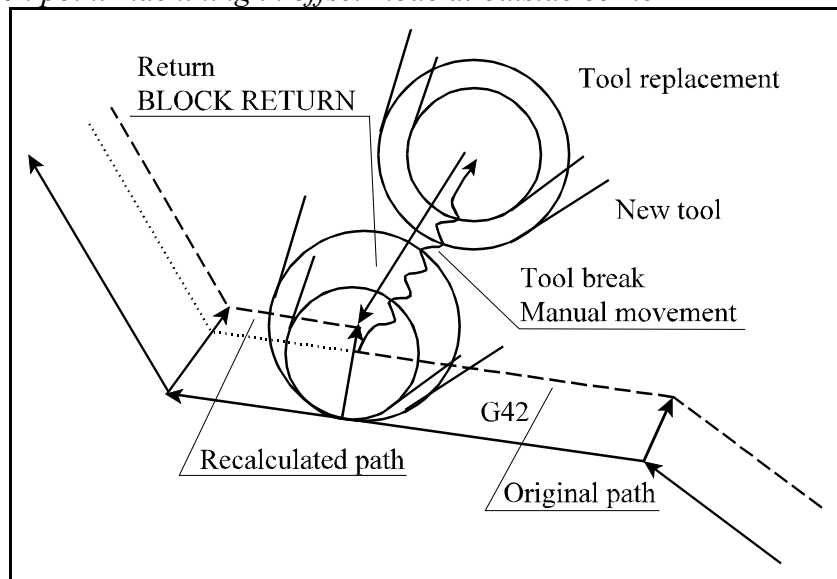
*6<sup>th</sup> case: Return to interruption point machining in offset mode at inside corner*

When condition BLOCK RETURN  is on ma-

chining inside a corner, corresponds to that of a outside corner. However this time, as seen on the diagram, if the interruption occurred near the corner and the radius of the new tool is bigger than that of the old one, it cuts into the work. This can be surmounted if the tool is not led back fully to the interruption point, but is stopped earlier and condition

BLOCK RETURN  is switched off. From than on it corresponds to the process discussed in the chapter “**Unconditional Restart of Automatic Mode**”. Another possibility is to start a block search for the interrupted block, however this is the province of the following chapter.

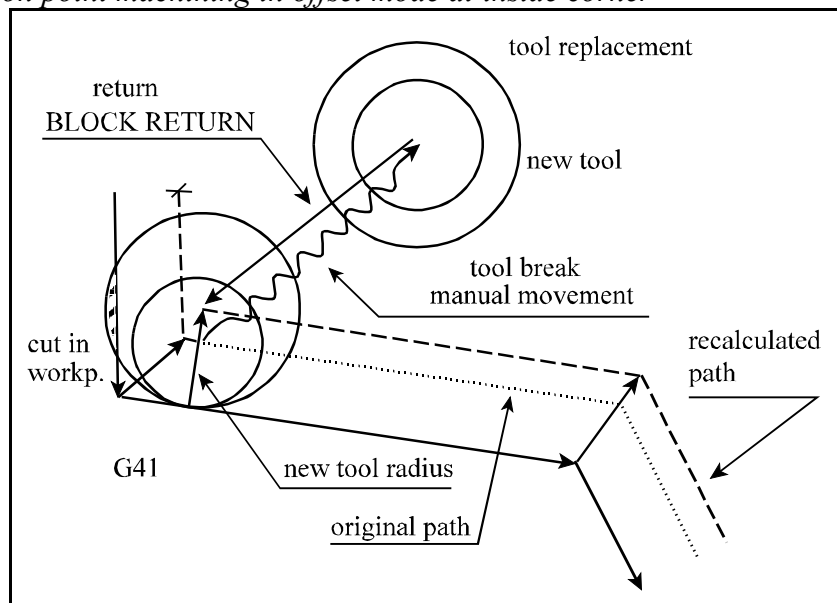

### 13.6 Automatic Operation Start after Block Search

In the course of machining there may be a need for executing the program selected for automatic mode not from the first block, but from a block within the program. For this, the appropriate block of the program has to be pointed at.

On the DIRECTORY screen the program must be selected for automatic execution, than VIEW screen needs to be displayed. The control is to be switched over to automatic mode



. In case of INTD state is displayed on status bar, it needs to be broken by the use of

RESET key.

If <sup>F4</sup> **BLOCK SEARCH** action is selected after pressing **action**

**menu** key the listing is

taken over by the program module preprocessor. The action block search can be activated on the following conditions:

- automatic mode is on,
- there may be no INTD state, i.e. the program execution must not be in interrupted state,
- VIEW screen should be displayed for viewing the program selected for automatic execution.

```

AUTM
VIEW 01000
> G94 G0 X280
> Z240
> T101
> G52 X4 Z2
> G42 G0 X210 Z210
> M3 M8 S500
> X200
> G1 Z20 F300
> G0 X210
> Z210
> G0 X200
> #100=#5001
> M98 P1001 L7
> M98 P1003
> G0 X120
> #100=#5001
> M98 P1002 L4
N1 L000001
FIRST LAST SEARCH GOTO INTERR CANCEL
1 2 3 4 UPTED 5 6 7 8 9 0
    
```

If one of the above conditions is not fulfilled, the contradicting state is shown by symbol  $\rightarrow\leftarrow$  in the 7<sup>th</sup> field of status bar.

#### 13.6.1 Pointing at the Desired Block. Entering the Repetition Count.

The highlighting bar displays the block pointed at. By means of the keys , ,

<PgUp> , <PgDn> the program can be browsed (as the bar is moved). With the help of softkeys <sup>F1</sup> FIRST and <sup>F2</sup> LAST it goes to the beginning as well as the end of program on general displaying area.

If character <N> is pressed on the keyboard, a block number can be entered in the bottom data input line at address N, than after terminating the input (by the use of key or the

highlighting bar goes to the block searched for. In case it cannot find the block with the entered number it writes symbol ? (question mark) on the last character of address N.

In case of command M98 Ppppp the listing of subprogram No. pppp is started by the use of

key . In case of command M99 it returns to sub- or main program one level higher by

pressing key . If the number of the subprogram is not numeric, but is an arithmetic expression it will not open the subprogram.

If the subprogram is called by means of repetition count (L) the cycle number from which the program is to be executed can be specified. On the keyboard key <L> needs to be pressed, than the cycle number entered. If for example the subprogram call is M98 P155 L4, and L is given 2, cycles 2, 3 and 4 will be executed after block search (i.e. the subprogram is called three times). If block search is started from within the given subprogram the part left of the program is also taken into account in the value given to L.

### 13.6.2 Command SEARCH

If the desired block is selected and action key **F3 SEARCH** is pressed the control gathers all the information of the program to a table from the beginning of main program to the beginning of the selected block (to the end of the block preceding the selected block), which would occur at the moment of starting the execution of the selected block (at the end of the execution of the previous block), if the program had been executed from the beginning.

Message

**BLOCK NOT FOUND**

is displayed by the control if a not existing block number is searched for, or the repetition count given to L is bigger than the value written in the program.

Let us examine a fragment of the following part program:

```
%O1000 (EXAMPLE MAIN PROGRAM)
G94 G0 X280
Z240
T101
G52 X4 Z2
G42 G0 X210 Z210
M3 M8 M12 S500
X200
G1 Z20 F300
G0 X210
Z210
G0 X200
...
```

Let us start block search for block G0 X200. In this case the control gathers the information seen below.

#### Number of Tool to be Changed: T1.

In case tool replacement occurs as the effect of T function, the last T code is gathered.

#### .Spindle Gear Range Code: M12

#### Spindle Speed Code: S1000

The last spindle speed code is gathered.

ABSOLUTE		DIST. TO GO		END POS.	
X-	4.000	X	214.000	X	210.000
Z-	2.000	Z	22.000	Z	20.000
F	300.0000		300.0000	100%	100%
S	341		0	100%	654
T101 M12 S500 M3 M8					
M					
X	107.000	Z	22.000		

### **Spindle Rotation Code: M3**

The command referring to the last spindle rotation is gathered, in this case M3.

### **Coolant Code: M8**

The command referring to coolant handling is gathered, in this case M8.

### **Other Functions: M**

Other M functions in the program are listed in the 2<sup>nd</sup> line of the gathered information.

### **Positions**

The positions gathered always show a relative motion from the momentary position of the axes to the position, to which they will move after pressing the START button.

If a block G1, G2, G3, G33 was pointed at in the course of a block search, i.e., this is going to be the first block to be executed by control after the block search the table points at the start position of the selected block.

If the selected block contains rapid traverse positioning (G0, block) the positions of the table point at the end position of the selected block. In case a canned cycle has been selected, the same positions point at the end position in the selected plane.

*Afterwards the operator has to decide upon the order of registering the needed state.*

### **START Without Intervention**

If the operator presses START button in this state the control registers the needed state in the following order:

- first it executes the selected functions according to their order in the table (i.e. in this case: T1, M12, S500, M3, M8),
- last it positions along an n-dimensional straight line by moving simultaneously on all the axes. The positioning occurs by means of rapid traverse to the distance of 1000 increment measured vectorially from end position, than the distance to go is terminated by means of the valid feedrate.

### **Intervention by Means of Manual Operation Before START**



If a manual operation mode (Jog, Incremental jog, Manual handle feed) is selected before pressing the START button, then the distance, seen in general displaying area distance to go, can be moved by manual operation similarly to BLOCK RESTART and BLOCK RETURN conditions. The axes can be moved continuously in any (+/–) direction to the position, where the distance to go is 0. The axis moved automatically decelerates and stops on the selected coordinate. Thereafter this axis cannot be moved from this position.

There is no need to return fully to the position searched for, but the process can be continued by switching over to automatic mode and pressing START button. Afterwards the order of function execution corresponds to that discussed in the previous point.

By the use of this function the position calculated in the course of a block search can be approached in the desired path by avoiding the possible obstacles.

### Other Intervention Possibilities Before START

It is possible to change the order of execution, as well as to cancel the execution of other M codes before starting the execution of data gathered in automatic mode.

The cursor can be moved along the listed commands by means of keys , .

The cursor must be moved to the function or coordinate, the execution of which is to be taken out from the execution after the first START. When the cursor stands on it, key <INS>  is to be pressed. Due to this, the display of this data turns to dark.

When the **START button**  is pressed, the darkened commands are not executed, but those not taken out from the execution. After the selected commands are executed, the control assumes STOP state and displays the commands not executed in the first cycle. This time the ones, not to be executed when pressing START again can be selected in the above way. The process can be carried on until all the gathered commands are executed.

In the above example command M3 can be taken out from the first execution cycle, as well as movement Z-188.351 in order to prevent the tool from clashing when positioning. In this case after pressing the START button all functions but spindle rotation and every positioning but movement in Z direction are executed. If thereafter the START button is pressed, the spindle rotation is started and the tool moves to the workpiece in Z direction.

Regarding the gathered other M functions certain commands may have to be canceled. In this case the cursor must be moved to the function to be canceled, than key <DEL>  must be pressed. With the key in effect the function is canceled from the gathered list and is not executed.

*☞ Positioning, command referring to tool replacement, spindle and coolant cannot be canceled.*

### 13.6.3 Command GOTO

If the cursor is moved to the desired block and action key **F4 GOTO** is pressed, the control executes the program from the selected block after pressing START button. Contrary to command SEARCH it does not gather functions and positions from the beginning of program. It is the operator's duty to place the machine in the appropriate state and position. The effect of command GOTO is the same as if command GOTO<sub>n</sub> had been entered (n is the block number).

### 13.6.4 Search for INTERRUPTED Block

In the course of machining the control registers the block under execution. This registration is preserved upon power-off of the machine. Therefore if program execution is interrupted in the course of machining for example due to power cut, the program can be restarted. After the power has been turned on, reference point has been returned and the **action menu**



key has been pressed, **BLOCK SEARCH** action must be pressed on **VIEW** screen. By the use of **INTERRUPTED** softkey the control starts searching for the block, the execution of which has been interrupted. Afterwards the process corresponds to that of command <sup>F3</sup> **SEARCH**.



## 14 Listing of Messages and their Codes

There may be two types of messages: Local and global.

### 14.1 Local Message

**Local** messages are the ones connected to an action executed on a certain screen, and are not available on any other screen. These are for example the data input errors displayed by the control upon false input.

Local messages are displayed in the bottom right corner of screen above the softkeys.

Local messages are always due to some kind of handling error, therefore in order to go on the

message has to be canceled. Local messages are canceled by the use of key **CANCEL** .

Naturally switching over the screen also clears the message. The local messages and their interpretations are discussed by the description of screens.

### 14.2 Global Messages

**Global** messages are the ones not connected to an action executed on a certain screen. These messages can occur on any screen. This is the situation if for example machining is done in automatic operation, meanwhile a program is being edited on the EDIT screen. If in the course of machining the program module preprocessor finds a block specified incorrectly or PLC notices error in the machine a global message appears.

Global messages are displayed in the top left corner of the screen in the window maintained especially for this function below the status bar. A four-digit number is attached to every global messages, i.e., the code and text of the message.

Global messages can be divided into the following main groups:

#### *System alarms:*

- alarms due to failure or false setting of servo system,
- alarms due to failure of position encoders,
- HW/SW alarms coming from the NC,
- messages due to programming errors of the PLC program.

#### *Other NC error messages:*

- reference point return errors,
- errors due to moving to overtravel positions and forbidden areas.

#### *Messages sent by PLC program:*

- there may be alarms arising during functioning of the machine,
- or messages informing the operator.

#### *Error messages sent by program module preprocessor:*

- if the program module preprocessor finds error in the pre-processed program block during program execution it sends an error message.

#### *Messages arising from handling errors:*

- if the operator wishes to activate an intervention not possible in the given situation.

*Messages of custom macros:*



- error messages programmed by the user and waiting for to be canceled, or
- messages programmed by the user waiting for START.

In the case of global messages the different messages are needed to be answered differently, i.e., to be canceled. Therefore, in the enclosed table after each message the method of canceling it is shown. These may be as follows:

*Canceling message by means of turning power off and on*

In case of extremely serious or dangerous alarms the message cannot be canceled, the NC must be restarted. These messages cut the machine off the NC and create emergency stop (EMG) state every time.

*Canceling message by means of pressing RESET key* 

This is the general mode of canceling error messages. By the use of the RESET key  the automatic execution is interrupted. If thereafter the START button is pressed, the NC pre-processes the block and if the error has been repaired successfully it also re-executes the block. In case of extremely serious or dangerous alarms the message cuts the machine off the NC, creates emergency stop (EMG) state and deletes the reference point. After using the RESET  button, the machine can be turned on. Then the machine must be returned to the reference point.

*Canceling message by means of pressing START button* 

As the effect of certain messages displayed by the PLC program or custom macro messages written by the user the control assumes STOP state and waits for the operator's intervention in accordance with the message. After the wished operation has been done by the operator the machining is continued by means of START button .

*Canceling message by means of operator's intervention*

Certain messages can only be canceled by ceasing the reason of their appearance. This is the situation in the case of message LIMIT X+, which can only be canceled, if the limit switch is left behind by moving in negative direction in a manual mode.

## 14.3 Listing of Global Messages

Error Code	Message	Description	Canceling and Repairing Method
0	SERVO 1	If the position deviation value exceeds the value specified at the appropriate parameter, servo alarm occurs. In message SERVOn n=1...8 refers to the n <sup>th</sup> axis, while n=9 refers to spindle axis. This message is generated in EMG state.	This message causes EMG state and loss of reference point. It can be canceled by RESET.
1	SERVO 2		
2	SERVO 3		
3	SERVO 4		
4	SERVO 5		
5	SERVO 6		
6	SERVO 7		
7	SERVO 8		
8	SERVO 9		
20	ENCODER 1	If the monitor circuit detects a broken encoder wire, encoder alarm occurs. In message ENCODERn n=1...8 refers to the n <sup>th</sup> axis, while n=9 refers to spindle axis. This message is generated in EMG state.	This message causes EMG state and loss of reference point. It can be canceled by RESET.
21	ENCODER 2		
22	ENCODER 3		
23	ENCODER 4		
24	ENCODER 5		
25	ENCODER 6		
26	ENCODER 7		
27	ENCODER 8		
28	ENCODER 9		
40	FEEDBACK 1	If the axes are not able to keep up with the speed of interpolator within the value specified at parameter, feedback alarm occurs. In message FEEDBACKn n=1...8 refers to the n <sup>th</sup> axis, while n=9 refers to spindle axes. This message is generated in EMG state.	This message causes EMG state and loss of the reference point. It can be canceled by RESET.
41	FEEDBACK 2		
42	FEEDBACK 3		
43	FEEDBACK 4		
44	FEEDBACK 5		
45	FEEDBACK 6		
46	FEEDBACK 7		
47	FEEDBACK 8		
48	FEEDBACK 9		

14.3 Listing of Global Messages

Error Code	Message	Description	Canceling and Repairing Method
60	PLC TIMEOUT 1	If either module :001 or module :002 of PLC program does not expire in the time slice reserved for it, message PLC TIMEOUT 1 or 2 is displayed. This message is generated in EMG state.	This message can only be canceled by power-off of the control. In order to repair it, turn to a well-trained expert.
61	PLC TIMEOUT 2		
70	DPG TIMEOUT	If the interpolation cycle does not expire in the time slice reserved for it, message DPG TIMEOUT is displayed. This message is generated in EMG state.	This message can only be canceled by power-off of the control. In order to repair it, turn to a well-trained expert.
80	15V FAILURE	If the comparator circuit detects that the specified voltage is not available at the +/-15V output of power supply, message 15V Failure is displayed. This message is generated in EMG state.	This message can only be canceled by power off of the control. In order to repair it, turn to a well-trained expert.
90	SYNC. FAILURE 1	If the movement of two axes is synchronized (gantry axes) and the position deviation value of the two axes is larger than the value set at parameter, message SYNC. FAILURE n is displayed. n=1...8 refers to the number of synchronic axes. This message is generated in EMG state.	This message causes EMG state and loss of reference point. It can be canceled by RESET.
91	SYNC. FAILURE 2		
92	SYNC. FAILURE 3		
93	SYNC. FAILURE 4		
94	SYNC. FAILURE 5		
95	SYNC. FAILURE 6		
96	SYNC. FAILURE 7		
97	SYNC. FAILURE 8		
100	SHORT 000	If an interface output line is short-circuited or overloaded, message SHORT ijk is displayed, where: i=0 means the 1st, i=1 the 2nd, i=2 the 3rd and i=3 the 4th interface card and j=0 means the first, while j=2 means the second 16 output lines on the interface card. The short-circuited output line is not identified more exactly, k is always 0. This message is generated in EMG state.	This message causes EMG state and loss of reference point. It can be canceled by RESET.
120	SHORT 020		
200	SHORT 100		
220	SHORT 120		
300	SHORT 200		
320	SHORT 220		
400	SHORT 300		
420	SHORT 320		

Error Code	Message	Description	Canceling and Repairing Method
999	SHORT MON	This message is displayed, if MON (Machine ON) output of control is short-circuited or overloaded. This message is generated in EMG state.	This message causes EMG state and loss of reference point. It can be canceled by RESET.
1020	POSITION ERROR	This message is displayed, if the position lag does not reach the value specified at parameter within 5 seconds after the interpolator has stopped. The above detection is executed in case of command G00 if parameter 1241 POSCHECK is 1, or in case of feed movement in states G9 and G61.	The message is canceled by RESET key. In order to repair the cause of error, the input offsets of the drives must be zeroed.
1100	REFERENCE POINT t1	This message is displayed, if the reference point switch has not been found within the distance specified at parameter <i>REFDIS</i> (or if it cannot stop within that distance). Value of t is the name of the axis: X, Y, Z, U, V, W, A, B, C. In the error code (1100, 1110, 1120, ...) the digit on local value 10 (0, 1, 2, ...) +1 is the physical axis number.	The message is canceled by RESET key.
1110			
1120			
1130			
1140			
1150			
1160			
1170			
1101	REFERENCE POINT t2	This message is displayed if it cannot run off the switch within the distance specified at parameter <i>SWLENGTH</i> . Value of t is the name of the axis: X, Y, Z, U, V, W, A, B, C. In the error code (1101, 1111, 1121, ...) the digit on local value 10 (0, 1, 2, ...) +1 is the physical axis number.	The message is canceled by RESET key.
1111			
1121			
1131			
1141			
1151			
1171			

14.3 Listing of Global Messages

Error Code	Message	Description	Canceling and Repairing Method
1102	REFERENCE POINT t3	<p>This message is displayed, if the zero pulse has not been found after leaving the reference switch within the distance specified at parameter <i>SWSHIFT</i> + <math>\frac{3}{4}</math><i>ZERODIS</i>.</p> <p>Value of t is the name of the axis: X, Y, Z, U, V, W, A, B, C.</p> <p>In the error code (1102, 1112, 1122, ...) the digit on local value 10 (0, 1, 2, ...) +1 is the physical axis number.</p>	The message is canceled by RESET key.
1112			
1122			
1132			
1142			
1152			
1162			
1172			
1103	REFERENCE POINT t4	<p>If during the reference point return zero pulse is found, the axis changes its direction and searches for it again in the new direction at a lower speed. If this time it cannot find the zero pulse within 1000 increments, this message is displayed.</p> <p>Value of t is the name of the axis: X, Y, Z, U, V, W, A, B, C.</p> <p>In the error code (1103, 1113, 1123, ...) the digit on local value 10 (0, 1, 2, ...) +1 is the physical axis number.</p>	The message is canceled by RESET key.
1113			
1123			
1133			
1143			
1153			
1163			
1173			
1104	REFERENCE POINT t5	<p>This message is displayed, if during the reference point return zero pulse is found after running off the switch within the distance specified at parameter <i>SWSHIFT</i> + <math>\frac{1}{4}</math><i>ZERODIS</i>.</p> <p>Value of t is the name of the axis: X, Y, Z, U, V, W, A, B, C.</p> <p>In the error code (1104, 1114, 1124, ...) the digit on local value 10 (0, 1, 2, ...) +1 is the physical axis number.</p>	The message is canceled by RESET key.
1114			
1124			
1134			
1144			
1154			
1164			
1174			

Error Code	Message	Description	Canceling and Repairing Method
1105	REFERENCE POINT t6	This message is displayed, if during reference point return in case of distance-coded measuring system the distance between two zero pulses is not in accordance with the values of parameter <i>ZERODIS</i> . Value of t is the name of the axis: X, Y, Z, U, V, W, A, B, C. In the error code (1105, 1115, 1125, ...) the digit on local value 10 (0, 1, 2, ...) +1 is the physical axis number.	The message is canceled by RESET key.
1115			
1125			
1135			
1145			
1155			
1165			
1175			
1300	FORBIDDEN AREA t+	This message is displayed, if an externally forbidden area has been specified by means of command G22, and one of the axes runs on the limit of this area in direction +, or is in the forbidden area at the moment of specification. Value of t is the name of the axis: X, Y, Z, U, V, W, A, B, C. In the error code (1300, 1301, 1302, ...) the digit on local value 1 (0, 1, 2, ...) +1 is the physical axis number.	The error can be canceled only if the axes are moved away from the zone limit by means of manual intervention. If in the moment of selection one of the axes is in the forbidden area, first the specification must be canceled by means of command G23.
1301			
1302			
1303			
1304			
1305			
1306			
1307			
1320	FORBIDDEN AREA t-	This message is displayed, if an externally forbidden area has been specified by means of command G22, and one of the axes runs on the limit of this area in direction -, or is in the forbidden area at the moment of specification. Value of t is the name of the axis: X, Y, Z, U, V, W, A, B, C. In the error code (1320, 1321, 1322, ...) the digit on local value 1 (0, 1, 2, ...) +1 is the physical axis number.	The error can be canceled only if the axes are moved away from zone limit by means of manual intervention. If in the moment of selection one of the axes is in the forbidden area, first the specification must be canceled by means of command G23.
1321			
1322			
1323			
1324			
1325			
1326			
1327			

14.3 Listing of Global Messages

Error Code	Message	Description	Canceling and Repairing Method
1340	LIMIT t+	This message is displayed, if one of the axes has run on limit switch or on overtravel position specified at a parameter in direction –. Value of t is the name of the axis: X, Y, Z, U, V, W, A, B, C. In the error code (1360, 1361, 1362, ...) the digit on local value 1 (0, 1, 2, ...) +1 is the physical axis number.	The error can be canceled only by moving the axes away from the overtravel position by means of manual intervention.
1341			
1342			
1343			
1344			
1345			
1346			
1347			
1360	LIMIT t–	This message is displayed, if one of the axes has run on limit switch or on overtravel position specified at a parameter in direction –. Value of t is the name of the axis: X, Y, Z, U, V, W, A, B, C. In the error code (1360, 1361, 1362, ...) the digit on local value 1 (0, 1, 2, ...) +1 is the physical axis number.	The error can be canceled, only by moving the axes away from the overtravel position by means of manual intervention.
1361			
1362			
1363			
1364			
1365			
1366			
1367			
1380	SPINDLE LOOP OPEN	This message is displayed, if spindle indexing has been commanded on address C or by M function and orientation M19 has not been programmed previously.	The message is canceled by RESET key.
1400	INTERNALLY FORBIDDEN AREA	This message is displayed by the NC, if an internally forbidden area has been specified by means of command G22, and one of the axes runs on the limit of this area, or is in the forbidden area at the moment of specification.	The error can be canceled only if the axes are moved away from the zone limit by means of manual intervention. If in the moment of selection one of the axes is in the forbidden area, first the specification must be canceled by means of command G23.



Error Code	Message	Description	Canceling and Repairing Method		
2000	PLC ERROR 001	At most 152 different messages can be sent by PLC. The message texts are optional. In case no text is added by the programmer of PLC, message PLC ERROR ijk is displayed.  <i>For the list of messages and the description of messages turn to the machine tool builder.</i>	The message is canceled on the basis of the PLC program.  <i>For information on clearing the messages turn to the machine tool builder.</i>		
2001	PLC ERROR 002				
2002	PLC ERROR 003				
...					
...					
2150	PLC ERROR 151				
2151	PLC ERROR 152	At most 8 different indexed messages can be sent by PLC. The messages texts are optional. In case no text is added by the programmer of PLC, text PLC MESSAGE ijk is displayed. The message can be indexed with maximum 4 digits following the messages.  <i>For the list of messages and the description of messages turn to the machine tool builder.</i>	The message is cleared on the basis of the PLC program.  <i>For information on clearing the messages turn to the machine tool builder.</i>		
2500	PLC MESSAGE 1				
2501	PLC MESSAGE 2				
2502	PLC MESSAGE 3				
2503	PLC MESSAGE 4				
2504	PLC MESSAGE 5				
2505	PLC MESSAGE 6				
2506	PLC MESSAGE 7				
2507	PLC MESSAGE 8	If mirror image (G50.1, G51.1) is switched on or off in the switched-on-state of scaling (G51), or rotation (G68).	The message is canceled by RESET key.		
3000	MIRROR IMAGE IN G51, G68				
3001	VALUE EXCESS X,Y,...F			If coordinate or feed data exceeds value range permitted.	The message is canceled by RESET key.
3002	PLANE SELECTION IN G68			If plane selection (G17, G18, G19) is executed in the switched-on-state of coordinate rotation.	The message is canceled by RESET key.
3003	COORDINATE ADDRESS G68			If an axis outside the selected plane is specified in command G68 when giving the center of rotation.	The message is canceled by RESET key.
3004	MISSING REFERENCE POINT	If reference point return has not been performed before absolute movement is programmed on an axis.	The message is canceled by RESET key.		
3005	ILLEGAL G CODE	If no function or custom macro call has been defined for a G code referred to or two or more conflicting G codes in a block are specified.	The message is canceled by RESET key.		

### 14.3 Listing of Global Messages

<b>Error Code</b>	<b>Message</b>	<b>Description</b>	<b>Canceling and Repairing Method</b>
<b>3006</b>	VALUE EXCESS H, D, P	If in tool offset selection (H) or (D) the number entered under the address exceeds the range permitted. The same error occurs in case of value P of command G10 L(10, 11, 12, 13).	The message is canceled by RESET key.
<b>3007</b>	G43, G44, H IN G2, G3	If in a block containing circular interpolation (G2, G3) tool length offset is programmed (G43, G44, H)	The message is canceled by RESET key.
<b>3008</b>	ERRONEOUS G45...G48	If radius compensation code (D) is changed when using G45...G48 or the use of code G45...G48 results in conflict.	The message is canceled by RESET key.
<b>3009</b>	G45...G48 IN G41, G42	If code G45...G48 is used when G41 or G42 is switched on.	The message is canceled by RESET key.
<b>3010</b>	PLANE SELECT. IN G41, G42	If plane selection (G17, G18, or G19) is programmed in offset mode (G41, G42).	The message is canceled by RESET key.
<b>3011</b>	RADIUS DIFFERENCE	If the difference between the start point radius and the end point radius of a circular arc exceeds the value specified in parameter 1021 RADDIF.	The message is canceled by RESET key.
<b>3012</b>	ERRONEOUS CIRCLE DEF. R	If in circular interpolation definition (G2, G3) radius (R) had been specified and the start point and end point coincide.	The message is canceled by RESET key.
<b>3013</b>	MULTITURN CIRCLE FAILURE	If at multiturn circle definition (polar coordinate specification G16 is on) the polar angle change is not negative in case of G2 or not positive in case of G3.	The message is canceled by RESET key.
<b>3014</b>	ERRONEOUS CIRCLE DEF.	If when programming circular interpolation (G2, G3) neither the radius (R) nor the center coordinate (I, J, K) is defined, or the specification of center coordinates conflicts with the selected plane (G17: I, J; G18: I, K; G19: J,K).	The message is canceled by RESET key.
<b>3015</b>			
<b>3016</b>	FORBIDDEN ADDRESS	If an address has been referred to in the program that is forbidden or conflicting in that situation.	The message is canceled by RESET key.
<b>3017</b>	,C AND ,R IN ONE BLOCK	If chamfering (,C) and corner round (,R) have been programmed in the same block.	The message is canceled by RESET key.

<b>Error Code</b>	<b>Message</b>	<b>Description</b>	<b>Canceling and Repairing Method</b>
<b>3018</b>	,A IN G2, G3	If in circular interpolation block (G2, G3) angle (,A) has been programmed.	The message is canceled by RESET key.
<b>3019</b>	DOMINATOR CONSTANT=0	If in 3D radius compensation calculation the value of dominator constant is 0.	The message is canceled by RESET key.
<b>3020</b>	DATA DEFINITION ERROR G33,G34	If in block G33, G34 more than 2 axes have been programmed, or both E and F are filled out, or the thread lead is 0, or ,C or ,R has been programmed.	The message is canceled by RESET key.
<b>3021</b>	G51 IN G33	If in block G33 scaling (G51) is on.	The message is canceled by RESET key.
<b>3022</b>	DIVIDE BY 0 IN G33	If G33 has been programmed and value E is less than or equal with 0, or the pulse number of spindle encoder on parameter 5023 ENCODERS1 is 0.	The message is canceled by RESET key.
<b>3023</b>	DATA DEFINITION ERROR G26	In block G26 an address not interpreted has been specified or there is a value specification error at an interpreted address.	The message is canceled by RESET key.
<b>3024</b>	ERRONEOUS P VALUE IN G96	If in block G96 (programming constant surface speed) value P is not 1...9.	The message is canceled by RESET key.
<b>3025</b>	DEFINITION ERROR S	If programmed spindle revolution (S) is greater than 65000 or negative or in canned cycles G84.2, G84.3 equals to 0.	The message is canceled by RESET key.
<b>3026</b>	DEFINITION ERROR G10 L3	If in block G10 L3 (filling up the life time table) P or L are in one block under address T, H or D or other address was programmed.	The message is canceled by RESET key.
<b>3027</b>	DEFINIT. ERROR T IN G10 L3	If in block G10 L3 (filling up the life time table) address T is defined without a group being referred to.	The message is canceled by RESET key.
<b>3028</b>	MORE TOOLS IN G10 L3	If in block G10 L3 (filling up life time table) the number of tools within a group exceeds the maximum value registered on parameter 1181 GROUPNUM.	The message is canceled by RESET key.

### 14.3 Listing of Global Messages

<b>Error Code</b>	<b>Message</b>	<b>Description</b>	<b>Canceling and Repairing Method</b>
<b>3029</b>	GROUP NUMBER IS TOO HIGH	If in block G10 L3 (filling up life time table) the number of tool groups exceeds the maximum value registered on parameter 1181 GROUPNUM.	The message is canceled by RESET key.
<b>3030</b>	DEFINITION ERROR T	If tool call is being programmed (address T) and value T is greater than 9999, or is negative.	The message is canceled by RESET key.
<b>3031</b>	ALL TOOL LIVES ARE OVER	If, in case of tool selection, all tool lives within the group referred to (address T) has expired.	The message is canceled by RESET key.
<b>3032</b>	CONFLICTING M CODES	If conflicting M codes have been programmed.	The message is canceled by RESET key.
<b>3033</b>	DEFINITION ERROR M	If M function is being programmed and the value, written under the address, is greater than 999 or is negative.	The message is canceled by RESET key.
<b>3034</b>	DEFINITION ERROR A,B,C	If address A, B or C is specified as function and its value is greater than 65000.	The message is canceled by RESET key.
<b>3035</b>	DEFINITION ERROR P	If dwell is being programmed (G4 or canned cycle) and value P is greater than 105, or is negative, if in block G4 address P is not filled out, if in block G5.1 or G10 it is filled out incorrectly.	The message is canceled by RESET key.
<b>3036</b>	G39 CODE IN G40	If block G39 is programmed in state G40 or in 3D tool radius compensation mode.	The message is canceled by RESET key.
<b>3037</b>	G39 NOT IN G1,G2,G3	If block G39 is programmed and the previous block is not G1, G2 or G3.	The message is canceled by RESET key.
<b>3038</b>	DEFINITION ERROR Q	In case of intersection calculation has not been specified on address Q which intersection is to be calculated, in G70, G71, G72, G73 turning cycles the end block number of the profile has not been specified, in the G76 multiple thread cutting cycle the first cut specified on Q is not interpretable.	The message is canceled by RESET key.
<b>3039</b>	G38 CODE IN G40	If a vector hold block (G38) is programmed in state G40 or in 3D tool radius compensation mode.	The message is canceled by RESET key.

<b>Error Code</b>	<b>Message</b>	<b>Description</b>	<b>Canceling and Repairing Method</b>
<b>3040</b>	G38 NOT IN G0, G1	If vector hold block G38 was programmed and the interpolation code is not G0 or G1.	The message is canceled by RESET key.
<b>3041</b>	AFTER G2, G3 ILLEG. BLOCK	If in offset mode (G41, G42) an offset mode cancel block (G10, G20, G21, G22, G23, G28, G29, G30, G31, G37, G52, G53, G54, ..., G59, G92) is programmed after circular interpolation block.	The message is canceled by RESET key.
<b>3042</b>	G40 IN G2, G3	If offset mode was going to be canceled in mode G2 or G3: G40 G2 X Y R.	The message is canceled by RESET key.
<b>3043</b>	G41, G42 IN G2, G3	If start-up of offset mode was going to be performed in mode G2 or G3: G40 G41 G2 X Y R.	The message is canceled by RESET key.
<b>3044</b>	G41, G42 DEFINITION ERROR	If offset mode is turned on for the duration of one movement block: G40... G41 X Y G40 X Y.	The message is canceled by RESET key.
<b>3045</b>			
<b>3046</b>	NO INTERSECTION G41, G42	If in offset mode (G41, G42) point of intersection cannot be determined between the current and next movement block.	The message is canceled by RESET key.
<b>3047</b>	CHANGE NOT POSSIBLE	If in offset mode (G41, G42) the direction change (G41 → G42 or G42 → G41) is not feasible even by relocation of the circle center.	The message is canceled by RESET key.
<b>3048</b>	INTERFERENCE ALARM	If in offset mode (G41, G42) interference alarm occurs.	The message is canceled by RESET key.
<b>3049</b>	CIRCLE ARC TOO LONG	If the arc of a circle (G2, G3) is too long.	The message is canceled by RESET key.
<b>3050</b>	NO REFRNC POINT G29, G30	If no reference point return has been done on axes programmed in the block when executing command G29 or G30.	The message is canceled by RESET key.

### 14.3 Listing of Global Messages

Error Code	Message	Description	Canceling and Repairing Method
3051	G22, G28, ... G31, G37	If in block G22 incorrect address is found, if in block G22 P is not 0 or 1, if in block G22 relation between the value of addresses X Y Z and I J K is incorrect, if in block G22 reference was made to a non-existing axis, if in block G28, G29, G30 address different from axis address, addresses N, P, F, M, S, T has been programmed, if in block G30 P is not 1, 2, 3, 4, if in block G31 address different from axis address, N and F has been programmed, if in a block G37 0 displacement has been programmed or more than one coordinate has been referred to.	The message is canceled by RESET key.
3052	ERROR IN G76, G87	If drilling cycle G86.1 is programmed and the facility of spindle orientation is not incorporated, or if a drilling cycle G87 is programmed, the spindle can be oriented but cycle is in state G99.	The message is canceled by RESET key.
3053	NO BOTTOM OR R POINT	If in the canned cycle R point or bottom (Z) point has not been defined.	The message is canceled by RESET key.
3054	G31 IN INCORRECT STATE	If in block G31 state G16 is on, if state G41 or G42 is active, if one of the transformations (G51, G51.1, G68) is on, if the state G16 or G95 is active.	The message is canceled by RESET key.
3055	G37 IN INCORRECT STATE	If in block G37 state G16 is on, if length offset G code (G43, G44, G49) has been programmed, if one of the transformations (G51, G51.1, G68) is on.	The message is canceled by RESET key.
3056	LIMIT	If parameter 3163 CHBFMOVE is set to 1 and the end position of programmed block exceeds the overtravel limit specified by parameter.	The message is canceled by RESET key.
3057	FORBIDDEN AREA	If parameter 3163 CHBFMOVE is set to 1 and the end position of the programmed block is in the forbidden area specified by instruction G22.	The message is canceled by RESET key.
3058	NOT IN DNC	If during DNC machining command M99 P, GOTO or WHILE...DO occur in main program.	The message is canceled by RESET key.

<b>Error Code</b>	<b>Message</b>	<b>Description</b>	<b>Canceling and Re- pairing Method</b>
<b>3059</b>			
<b>3060</b>			
<b>3061</b>			
<b>3062</b>			
<b>3063</b>			
<b>3064</b>	BAD MACRO STATE- MENT	If the macro expression is syntactically incorrect.	The message is canceled by RESET key.
<b>3065</b>	TOO LONG BLOCK	If the programmed block does not have enough room in the buffer.	The message is canceled by RESET key.
<b>3066</b>	NO INTERSECTION POINT	If there is no intersection point (eg., in case of parallel straight lines, concentric circles etc.), when executing intersection point calculation.	The message is canceled by RESET key.
<b>3067</b>	FAULTY ,A IN G16	If there is no end position in case of referring to address ,A when specifying polar coordinate data.	The message is canceled by RESET key.
<b>3068</b>	FAULTY READ	If a false sector is read from memory during program execution.	The message is canceled by RESET key.
<b>3069</b>	LEVEL EXCESS	This message is displayed in case the permissible depth of subprogram is over 8 or that of the macro is over 4.	The message is canceled by RESET key.
<b>3070</b>	NOT EXISTING BLOCK NO. P, Q	If reference is made to a block number not specified in instruction M99 P, GOTO or in G70, G71, G72, G73 turning cycles.	The message is canceled by RESET key.
<b>3071</b>	MISSING OR FAULTY P	If, in case of subprogram call (M98 P) or macro call (G65 or G66 or G66.1 P), address P is not filled out, or P is greater than 9999, or P is negative.	The message is canceled by RESET key.
<b>3072</b>	DEFINITION ERROR L	If at address L repetition count (M98 P L, G65 P L, or in case of a canned cycle) has been programmed, or L was used in command G10, and L is greater than 65000.	The message is canceled by RESET key.

### 14.3 Listing of Global Messages

Error Code	Message	Description	Canceling and Repairing Method
3073	NOT EXISTING PROGRAM NO.	If, in case of subprogram call (M98 P) or macro call (G65 or G66 or G66.1 P), the program number specified at address P is not in the memory, subprogram or macro call has been selected for G, M, A, B, C, S, T and the referring subprogram is not in the memory, or the program executor called the subprogram or macro, which is being edited at the moment (EDIT screen).	The message is canceled by RESET key.
3074	ODD G67	If a modal macro end function is found (G67), the pair of which does not exist (G66, G66 1).	The message is canceled by RESET key.
3075	DEFINITION ERROR N	If the value of block number (N) is greater than 16000000.	The message is canceled by RESET key.
3076	NO END OF PROGRAM	If the program end is not defined by means of commands M2, M30, M99 or %.	The message is canceled by RESET key.
3077			
3078			
3079			
3080	ERRONEOUS USE OF #	Reference is made to a non-existing macro variable (#...), or to - in the given block - forbidden macro variable (#...).	The message is canceled by RESET key.
3081	DEFINITION ERROR ,C ,R	When programming chamfering or corner round in the block containing ,C or ,R or in the following block no coordinate in the selected plane has been programmed.	The message is canceled by RESET key.
3082	NO RETURN M99	No return (M99) was programmed at the end of a subprogram or a macro program.	The message is canceled by RESET key.
3083	R=0	If the start or end point radius is 0 in a programmed arc.	The message is canceled by RESET key.
3084	,C ,R TOO HIGH OR FORBIDDEN	If an impossible chamfering (,C) or corner round (,R) has been programmed.	The message is canceled by RESET key.
3085	CIRCLE ERROR G51	If scaling is programmed (G51 X Y Z I J K) and in circular interpolation different rates of scaling are on the different axes.	The message is canceled by RESET key.



<b>Error Code</b>	<b>Message</b>	<b>Description</b>	<b>Canceling and Repairing Method</b>
<b>3086</b>	DEFINITION ERROR G51	If scaling axis by axis is programmed (G51 X Y Z I J K) and X and U, or Y and V, or Z and W are in one block.	The message is canceled by RESET key.
<b>3087</b>	ILLEGAL PLANE SELECT	If in G76 multiple thread cutting cycle, on lathe control, not G18 plane is selected.	The message is canceled by RESET key.
<b>3088</b>	FORBIDDEN SPINDLE MOVING	If no spindle encoder is on the machine and an instruction demanding spindle encoder has been programmed (e.g. thread cutting, orientation).	The message is canceled by RESET key.
<b>3089</b>	BUFFER OVERRUN G41, G42	If buffer has been overrun in offset mode (G41, G42).	The message is canceled by RESET key.
<b>3090</b>	# DEFINITION PROHIBITED	Defining prohibited macro variable (#....). This may be due to its type (e.g., #1000, ... #1015), or it may be prohibited at parameters 9101 WRPROT1, 9102 WRPROT2.	The message is canceled by RESET key.
<b>3091</b>	ERRONEOUS OPERATION WITH #	If, in case of macro variables (#...), the operands and operations conflict. E.g.: if logical addition (AND) has been commanded between macro variables that cannot be represented in 32 bits in fix point mode.	The message is canceled by RESET key.
<b>3092</b>	DIVISION BY 0 #	If, in case of evaluating a macro expression, division is to be done by 0.	The message is canceled by RESET key.
<b>3093</b>	BUFFER OVERRUN #	Buffer has been overrun with macro variables.	The message is canceled by RESET key.
<b>3094</b>			
<b>3095</b>			
<b>3096</b>			
<b>3097</b>			
<b>3098</b>	ERRONEOUS ARGUMENT	If the function value exceeds the range. If e.g., SQRT[-4] or ASIN[2]), if, in case of instruction BCD, the transformed number is of more than 8 digits, if, in case of instruction BIN, not a BCD number is defined on the decades.	The message is canceled by RESET key.
<b>3099</b>			

14.3 Listing of Global Messages

<b>Error Code</b>	<b>Message</b>	<b>Description</b>	<b>Canceling and Repairing Method</b>
<b>3100</b>			
<b>3101</b>	BLOCK NOT FOUND	If the block searched for is not found and the end of program is reached (M2, M30 or %).	The message is canceled by RESET key.
<b>3102</b>	INCORRECT POSITION G12.1	If polar coordinate interpolation is on (G12.1) and the position of the 1st axis is 0, or the position of the 2nd axis is not 0.	The message is canceled by RESET key.
<b>3103</b>	OUT OF RANGE	This message is displayed, if the tool offset sensor signal does not come in within the distance which is specified at parameter 8002 ALADIST while executing tool length measurement block G37.	The message is canceled by RESET key.
<b>3104</b>	COMPENSTN VALUE TOO HIGH	If the modified wear offset value is out of the range of +/- 16000 increments when executing cycle G36, G37.	The message is canceled by RESET key.
<b>3105</b>	POCKET NUMBER IS TOO HIGH	If there are more than 10 concave pockets in the profile when executing the turning cycles G71, G72 in case of lathe controls.	The message is canceled by RESET key.
<b>3106</b>			
<b>3107</b>			
<b>3108</b>			
<b>3109</b>			
<b>3110</b>			
<b>3111</b>			
<b>3112</b>			
<b>3113</b>			
<b>3114</b>			
<b>3115</b>			
<b>3116</b>			
<b>3116</b>			
<b>3118</b>			
<b>3119</b>			
<b>3120</b>			
<b>3121</b>			
<b>3122</b>			

<b>Error Code</b>	<b>Message</b>	<b>Description</b>	<b>Canceling and Repairing Method</b>
3123			
3124			
3125			
3126			
3127			
3500	PROGRAM EDITED	This message is displayed, if program selected for automatic execution is edited in automatic mode, or if program selected for manual data input execution is edited in MDI mode, meanwhile START is pressed.	The message is canceled by RESET key. The program can be started if the EDIT screen is closed after terminating editing.
3502	BAD BAUD RATE VALUE	If not standard baud rate value or a baud rate that cannot be interpreted by control is set at parameter 2002 BAUD RATE. It is displayed in DNC mode. The values interpreted by the control are listed in the description of parameters.	The message is canceled by RESET key.
3503	SERIAL BUFFER FULL	If the serial buffer has been overrun in the course of DNC machining.	The message is canceled by RESET key. Data transfer must be restarted.
3504	TOOL PLACE TABLE BAD	If NC finds the check sum of the tool pot table false.	The message is canceled by RESET key. Tool pot table must be reorganized.
3505	NOT EXISTING PROGRAM	If a program had been selected for automatic or MDI execution, than the program was deleted and without selecting a new program START is pressed in automatic or MDI mode.	The message is canceled by RESET key.
3507	OVERWRITE (Y/N)	If the program being executed loads program to the control memory by means of command DPRNT, with the number of which a program has already been registered in the directory.	If the old program is to be overwritten key Y must be pressed, otherwise key N or RESET.

14.3 Listing of Global Messages

Error Code	Message	Description	Canceling and Repairing Method
3508	NC STATUS TABLE BAD	If the check sum of the memory area containing the general NC state, preserved upon power-off is false. These data are as follows: G20/G21: inch/metric input; the number of registered tool length compensation (H), and the axis, on which it is valid; the programs selected for automatic or MDI execution; DNC state; if the power is turned off during program execution, the program number, the execution of which, was interrupted.	The message is canceled by RESET key. The listed data must be reorganized.
3509	LIFE TIME TABLE BAD	If the check sum of the memory area containing the life time table, preserved upon power-off is false.	The message is canceled by RESET key. The life time table must be reorganized.
3510	TOOL OFFSET TABLE BAD	If the check sum of the memory area containing the tool offset table, preserved upon power-off is false.	The message is canceled by RESET key. The tool offset table must be reorganized.
3511	WORK OFFSET TABLE BAD	If the check sum of the memory area containing the work zero point offset table, preserved upon power-off is false.	The message is canceled by RESET key. The work zero point offsets must be measured again.
3514	OVERRUN ERROR	This message is displayed if in DNC operation during serial transfer two bytes overrun without the previous one being read by the control.	The message is canceled by RESET key. Loading must be restarted.
3515	PARITY ERROR	If in DNC operation through the serial interface, the control receives data of incorrect parity . This message is also displayed as a result of different parameter settings on the transmitter and receiver side.	The message is canceled by RESET key. Loading must be restarted.
3516	FRAMING ERROR	It occurs in DNC operation. Framing error is due to different parameter settings on the transmitter and receiver side. These are as follows: baud rate, word length, the number of stop bits.	The message is canceled by RESET key. Loading must be restarted.

Error Code	Message	Description	Canceling and Repairing Method
3518	DIRECTORY FULL	At most 254 programs can be stored, for the file manager built in control enables the registration of 254 programs in the directory. This message is displayed, if more programs are to be registered during program execution by the use of command POPEN. This does not necessarily mean, that the memory is full.	The message is canceled by RESET key. If a new program is to be opened one of the unnecessary old ones have to be deleted.
3519	MEMORY FULL	This message is displayed by the NC, if the storage built in control is full during program execution as the effect of command BPRNT or DPRNT.	The message is canceled by RESET key. One of the unnecessary old ones have to be deleted.
3520	FILE NOT EXISTS	If data is to be sent by means of command DPRNT or BPRNT and no channel is open with command POPEN.	The message is canceled by RESET key.
3524	FILE NOT OPEN	If an NC action refers to a file not open.	The message is canceled by RESET key. It is not the user's fault, the operator cannot repair it.
3528	INVALID ERROR CODE	If invalid error code has been generated while managing a file.	The message is canceled by RESET key. It is not the user's fault, the operator cannot repair it.
3530	SYSTEM ERROR	Internal communication error of the NC supervisor program.	The message is canceled by RESET key. It is not the user's fault, the operator cannot repair it.
3545	MACRO TABLE BAD	If checksum of the memory area containing macro variables #500...#599, preserved upon power-off is false.	The message is canceled by RESET key. The table of macro variables must be reorganized.

14.3 Listing of Global Messages

Error Code	Message	Description	Canceling and Repairing Method
3549	RESTORE MODAL FUNCTIONS? Y	If AUTOMATIC operation is started from INTD status by means of START, the control registers STOP status and question RESTORE MODAL FUNCTIONS? Y is displayed (Y=yes). By pressing <SHIFT> key question RESTORE MODAL FUNCTIONS? N is displayed (N=no). The message can be switched over by the use of <SHIFT> key. If START is pressed, the state before suspension is restored (Y), or not (N) according to the message.	The message is canceled by RESET key. INTD state remains.
3550	RESTORE MODAL FUNCTIONS? N		
4000	MACRO ERROR 000	The following text form is displayed by specifying the value of macro variable #3000: #3000=nnn(ERROR TEXT) where nnn=0,1,2,...999 and in the brackets an optional text can be entered. Number nnn defines the error code. (Code=4000+nnn) If it has not been filled out the error code will always be 4000. If no error text has been given to the variable the text will always be MACRO ERROR nnn, if it has been given, the text in brackets is displayed.	The message is canceled by RESET key.
4001	MACRO ERROR 001		
4002	MACRO ERROR 002		
...	...		
4999	MACRO ERROR 999		
5000	MACRO MESSAGE 000	The following text form is displayed by specifying the value of macro variable #3006 in part program: #3006=nnn(MESSAGE TEXT) where nnn=0,1,2,...999 and in the brackets an optional text can be entered. Number nnn defines the message code. (Code=5000+nnn) If it has not been filled out the message code will always be 5000. If no message text has been given to the variable the text will always be MACRO MESSAGE nnn, if it has been given, the text in brackets is displayed.	As the effect of the message the NC registers STOP state. By the use of START it moves on to the next block. The message is canceled by RESET key, but if thereafter START is pressed, as in all other cases, the message is displayed again.
5001	MACRO MESSAGE 001		
5002	MACRO MESSAGE 002		
...	...		
5999	MACRO MESSAGE 999		

## Notes

## Alphabetical index:

Access forbidden	<u>12</u>	Relative	<u>22</u>
Address	<u>56</u>	Power on	<u>14</u>
Alphabetical keys	<u>10</u>	Program format	<u>57</u>
Arrow keys	<u>10</u>	Program name	<u>56</u>
Beginning of program	<u>57</u>	Program number	<u>56</u>
Block	<u>56</u>	RESET	<u>10, 102</u>
CANCEL	<u>10</u>	Scrolling and editing keys	<u>10</u>
Conflicting state	<u>12</u>	SHIFT	<u>10</u>
Control Panel	<u>8</u>	Softkeys	<u>10</u>
Delete keys	<u>10</u>	Spindle stop button	<u>16</u>
Display unit	<u>8</u>	Status Bar	<u>11</u>
Editing		Word	<u>56</u>
Part Programs	<u>56</u>		
Emergency stop	<u>14</u>		
End of program	<u>57</u>		
FEED HOLD	<u>12</u>		
Line Feed	<u>56, 57</u>		
M19	<u>22</u>		
Machine Control Panel	<u>13</u>		
Monitor	<u>8</u>		
NC ready	<u>13</u>		
Numeric input keys	<u>10</u>		
Operation Mode Group	<u>11</u>		
Override buttons	<u>15</u>		
Parameter			
ALADIST	<u>138</u>		
BAUD RATE	<u>139</u>		
CHBFMOVE	<u>135</u>		
CLCV	<u>47</u>		
CROSS DOT	<u>44</u>		
ENCODERn	<u>124</u>		
ENCODERS1	<u>132</u>		
FEEDBACKn	<u>124</u>		
FMULT	<u>96</u>		
GROUPNUM	<u>132</u>		
RADDIF	<u>131</u>		
RAPOVER	<u>91</u>		
REFDIS	<u>126</u>		
SWLENGTH	<u>126</u>		
SWSHIFT	<u>126</u>		
WRPROT	<u>137</u>		
ZERODIS	<u>126, 127</u>		
Position	<u>22</u>		
Absolute	<u>22</u>		
End	<u>22</u>		
Machine	<u>22</u>		
Overall	<u>22</u>		