

SANGEAN

Operating instruction **GB**

K-200

FM / AM / Aux-in Digital Tuning Clock Radio

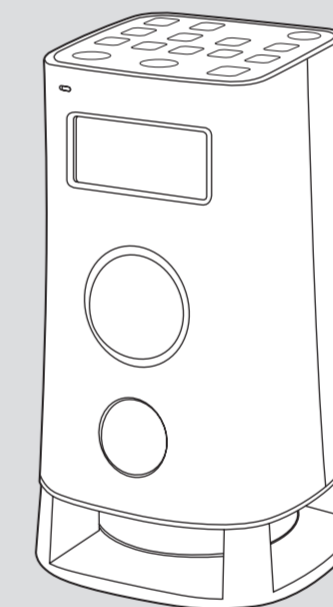

WARNING:
TO PREVENT FIRE OR ELECTRIC SHOCK HAZARD, DO NOT EXPOSE THIS PRODUCT TO RAIN OR MOISTURE.



3A81TT0S10000







Table of Contents

<i>Important Safety Instructions</i>	2-3
<i>Introduction</i>	4
<i>Controls and connections</i>	5-8
<i>Display icons</i>	9
<i>Using the Radio for the First time</i>	10
<i>Operating your radio – Search tuning AM/FM</i>	11
<i>Manual tuning – AM/FM</i>	12
<i>Setting up the tuning step increment</i>	13
<i>Display Modes – FM</i>	14
<i>Presetting Stations / Recalling a Preset in</i> <i>AM/FM modes</i>	15
<i>Clock and Alarms</i>	16-21
<i>Snooze & Auto Off Timer</i>	21-22
<i>Egg timer</i>	23
<i>Display & Audio</i>	24-27
<i>Specification</i>	28

Important Safety Instructions

1. Read and understand all safety and operating instructions before the radio is operated.
2. Retain instruction: The safety and operating instructions should be retained for further reference.
3. Heed warnings. All warnings on the appliance and operating instructions should be followed.
4. Follow all operations and use instructions.
5. Water and moisture: The appliance should not be used near water. Do not use near a bathtub, washbowl, laundry tub, kitchen sink, wet basement, swimming pool, etc.
6. Unplug the radio from the AC power outlet before cleaning. Use only a damp cloth for cleaning the exterior of the radio.
7. Do not place the radio on an unstable cart, stand, bracket or table. The radio may fall, causing serious personal injury and damage to the radio.
8. Ventilation: This radio should be situated so that its location or position does not interfere with its proper ventilation. For example, the radio should not be used on a bed, sofa, rug or other soft surfaces that may block the ventilation openings. It should not be placed in a built-in situation like a cabinet that may reduce air flow through the ventilation openings.
9. Power sources: The radio should be operated only from the type of power source indicated on the marking label. If you are not sure of the type of power supply to your home, consult your radio dealer or power company.
10. Mains adaptor: The mains adaptor should be positioned so it is not walked on, pinched, or items placed on top of it. Pay particular attention to wires at plugs, convenience receptacles, and the point where they exit from the unit. Unplug the mains adaptor by gripping the adaptor, not the wire. Operate the radio using only the current type of power source indicated. If you are not sure of the type of power supply to your home, consult your dealer or local power company.
11. Do not overload wall outlets or extension cords. This can result in a risk of fire or electrical shock. Never insert objects of any kind into the radio through opening. The objects may touch dangerous voltage points or short out parts. This could cause a fire or electrical shock.
12. If the radio is left unattended or unused for long periods of time, unplug it from the wall outlet. This will prevent damage caused by lightning or power line surges.
13. If the radio is left unattended or unused for long periods of time, remove the batteries. The batteries may leak and damage furniture or your radio.

GB

- 
- 
14. Do not attempt to service the radio yourself. Removing the cover may expose you to dangerous voltage, and will void the warranty. Refer all servicing to authorized service personnel.
 15. Object and Liquid Entry-Never push objects of any kind into this radio through opening as they may touch dangerous voltage points or short-out parts that could result in a fire or electric shock. Never spill liquid of any kind of product.
 16. The appliance should be serviced by qualified personnel when:
 - A. The mains adaptor or the plug has been damaged.
 - B. Objects have fallen or liquid had been spilled into the radio.
 - C. The radio has been exposed to rain or water.
 - D. The radio does not appear to operate normally or exhibits a marked change in performance.
 - E. The radio has been dropped, or the enclosure damaged.



Introduction

The Sangean K-200 AM/FM RDS Digital Tuning Radio provides the following range of features in a stream-lined portable size:

- Ⓞ Radio for AM and FM (with RDS) broadcasts.
- Ⓞ 10 radio station presets (5 for AM and 5 for FM)
- Ⓞ Clock display with time when in standby.
- Ⓞ Two alarm timers with snooze feature to wake you to either buzzer, radio alarm, or voice messages.
- Ⓞ Adjustable Auto Off Timer which can be set to turn the digital receiver off after between 15 and 120 minutes.
- Ⓞ 2 voice message recording function with each 30 seconds duration.
- Ⓞ A 3.5mm stereo Auxiliary Input socket for playing audio from MP3 players, iPod devices or other audio equipment.
- Ⓞ A kitchen egg timer for your cooking's convenience.
- Ⓞ A standard 3.5mm headphone socket for private listening.
- Ⓞ Attractive, large and ergonomically designed knobs.
- Ⓞ Desirable and functional flat membrane push button.
- Ⓞ Built-in AM antenna and external FM wire spring aerial for radio reception.

GB

Controls and connections

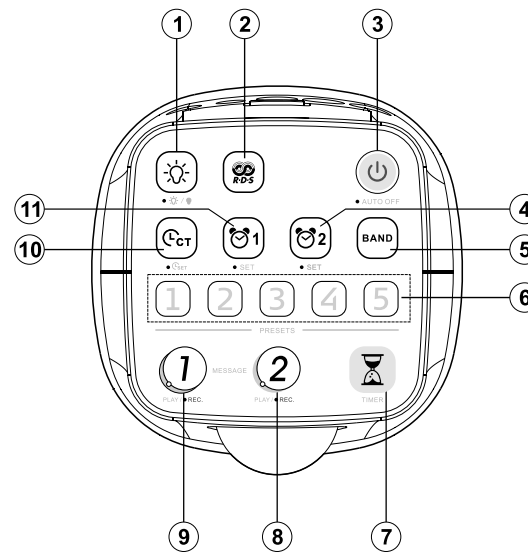

1. Backlight button
2. RDS button
3. Standby / Auto off
4. Alarm 2 button
5. Band button
6. Station presets

7. Egg Timer button
8. Message 2 button
9. Message 1 button
10. CT (auto clock time) button
11. Alarm 1 button

Controls and connections

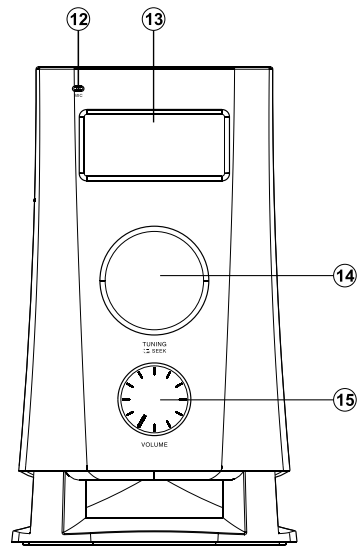

GB

- 12. Built-in Microphone
- 13. LCD display

- 14. Tuning control knob
- 15. Volume control knob

Controls and connections

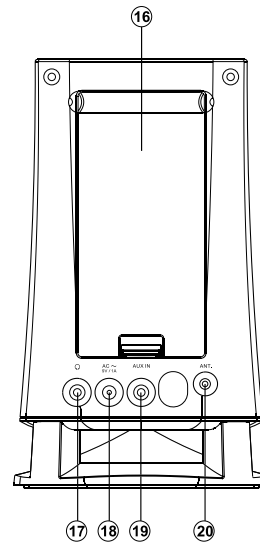

- 16. Battery compartment
- 17. Headphone socket
- 18. AC in socket

- 19. Aux in socket
- 20. FM Antenna jack

Controls and connections

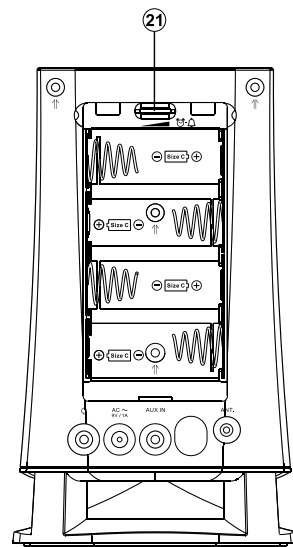

GB

21. Buzzer level control

Display icons

- A. Battery capacity indicator
- B. PM display
- C. Time indicator
- D. RDS icon
- E. Signal bar
- F. CT icon
- G. Alarm 2 indicator
- H. Alarm 1 indicator
- I. Frequency display
- J. Timer icon

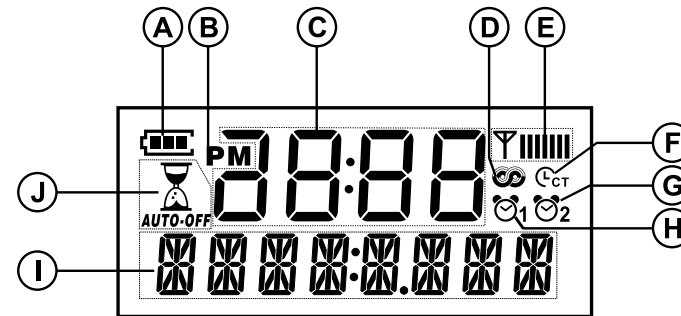

Using the radio for the first time

A. AC operation

1. Place your radio on a flat surface.
2. Insert the adaptor plug into the AC socket located on the back of your radio ensuring that the plug is pushed fully into the socket.
3. Plug the other end of the adaptor into the wall socket.

IMPORTANT:

The mains adaptor is used as the means of connecting the digital receiver to the mains supply. The mains socket used for the radio must remain accessible during normal use. In order to disconnect the radio from the mains completely, the adaptor should be removed from the mains socket outlet completely.

B. Battery operation

1. Turn the unit upside down. Locate the battery compartment door tab, press down on the door tab and lift the cover up to open.
2. Insert 4 x "C" size/UM-2/R14 batteries. Be sure to follow the polarity markings. Replace the battery compartment cover.
3. If the radio is not to be used for any extended period of time, it is recommended that the batteries are removed from the radio. Reduced power, distortion and a "stuttering sound", low battery sign  flashing on the display, and "LOW VOLT" are all signs that the batteries need replacing or recharging.

GB

Operating your radio – Search tuning AM/FM

1. Press the Standby button to switch on your radio.
2. Press the Band button as needed until the AM or FM band is selected.
3. Press and release the Tuning knob to carry out an auto-tune.
Your radio will scan up the AM/FM band from the currently displayed frequency and will stop scanning automatically when it finds a station of sufficient strength.
4. The display will show the frequency of the signal found. If the signal is strong enough and there is RDS information available, the display will show the radio station name soon after and the RDS icon will appear on the display.
5. When the end of the waveband is reached your radio will recommence tuning from the opposite end of the waveband.
6. Use the Volume control to adjust the sound level as required.

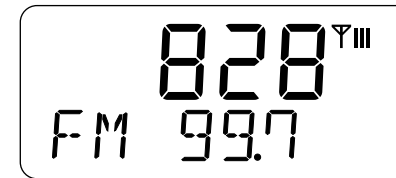
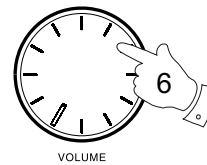
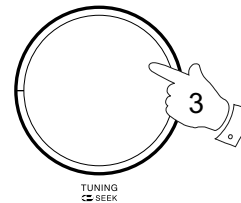
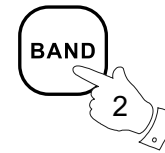
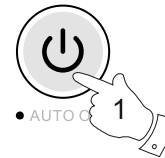

Manual tuning – AM/FM

1. Press the Standby button to switch on your radio.
2. Press and release the Band button to select AM or FM radio mode.
3. Rotate the Tuning control to tune to a station. The FM frequency will change in steps of 200kHz (American version) / 100kHz (European version) and AM frequency will change in steps of 10kHz (American version) / 9kHz (European version).
4. When the end of the waveband is reached your radio will recommence tuning from the opposite end of the waveband.
5. Use the Volume control to adjust the sound level as required.



Setting up the tuning step increment

1. Make sure your radio is in power off mode.
2. Press and hold the Tuning control knob until the setting of time format begins to flash.
3. After setting up the time format, press and release the Tuning control to enter the step increment setting.
4. Rotate the Tuning control knob to select either 100kHz or 200kHz for FM radio, and or 9kHz/10kHz for AM radio. Then press and release the Tuning control to confirm the setting.

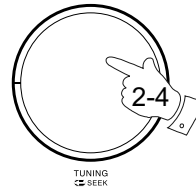

CLOCK 12H

FM 100KHZ

FM200KHZ

AM 10KHZ

AM 9KHZ

Display modes – FM

Your radio has a range of display options for FM radio mode.

1. Repeatedly press and release the RDS button to view the RDS information of the station you are listening to.

- a. Station name Displays the name of the station being listened to.
- b. Program type Displays the type of station being listened to such as Pop, Classic, News, etc.
- c. Radio text Displays radio text messages such as new items etc.
- d. Frequency Displays the frequency of the FM for the station listened to.

Note:

If no RDS information is available, then the radio will only be able to display the frequency. There will be no text or program type information available under these conditions.

The radio only provides displays when there is information available. So if there is no text, for example, that display is not available.

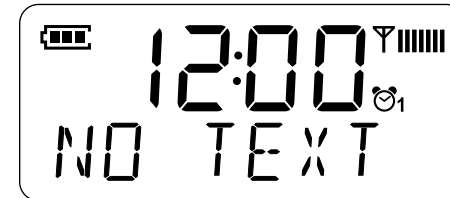
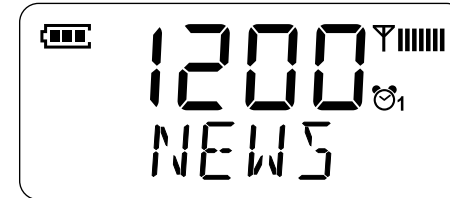
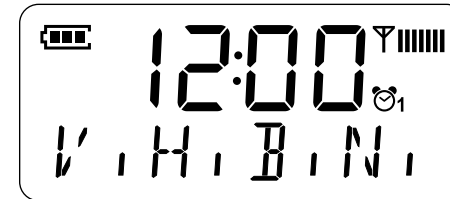

GB

Presetting stations in AM/FM modes

There are 5 preset stations each for AM and FM radio. They are used in the same way for each waveband.

1. Press the Standby button to switch on your radio.
2. Press the Band button to select the desired waveband. Tune to the required radio station as previously described.
3. Press and hold the required main Preset button (1 to 5) until the display shows "P1" after the frequency. The station will be stored using the preset number. Repeat this procedure for the remaining presets as you wish.
4. Preset stations which have already been stored may be overwritten by following the above procedure if required.

Recalling a preset in AM/FM modes

1. Press the Standby button to switch on your radio.
2. Select the required waveband by pressing the Band button.
3. Momentarily press the required main Preset button to cause your radio to tune to one of the stations stored in the 5 main presets.

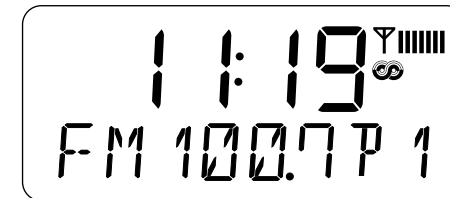
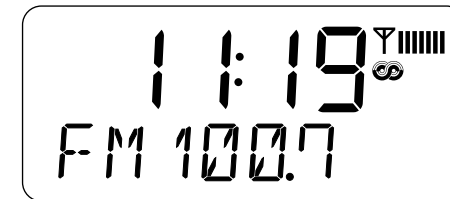
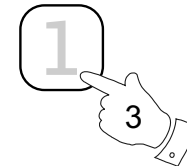
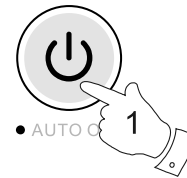

Clock and Alarms

Setting the time format

The clock display used in stand-by mode and on the playing mode screens can be set to 12 or 24 hour format. The selected format is then also used when setting the alarms.

1. Make sure your radio is in power off mode.
2. Press and hold the Tuning control knob until the radio beeps twice and the setting of time format begins to flash.
3. Rotate the Tuning control to select either 12 or 24 hour format.
Press and release the Tuning control to confirm your choice of clock format. The display will then revert to the previous menu.

If the 12 hour clock format is chosen, the radio will then use the 12 hour clock for the setting of alarms, and will display a 12 hour clock for the setting of alarms, and will display a 12 hour clock with a PM indicator when in stand-by mode.

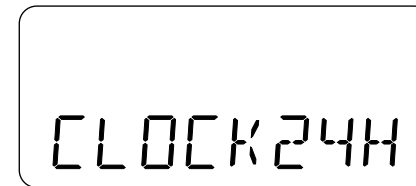
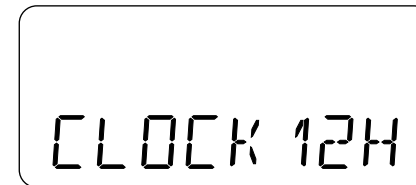
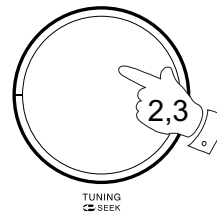

GB

Setting the clock time manually

1. Press the Standby button to switch on your radio.
2. Press and hold the CT button until the radio beeps once to enter the clock time setting, and the hour setting will begin to flash. The display will show "CLOCKSET".
3. Rotate the Tuning control to select the desired hour, and press and release the Tuning control to confirm the setting. Then rotate the Tuning control to select the desired minute, and press and release the Tuning control to confirm the setting.
4. Rotate the Tuning control to select the desired month, and press and release the Tuning control to confirm the setting. Then rotate the Tuning control to select the desired date, and press and release the Tuning control to confirm the setting.
5. Rotate the Tuning control to select the desired year, then press and release the Tuning control to confirm the setting.

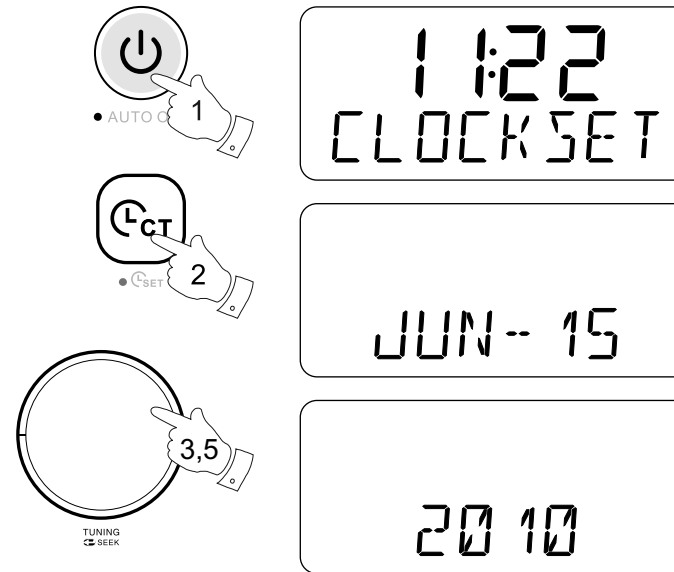



Setting the clock time using RDS CT

1. Tuning to a station transmitting RDS data, and press and release the CT button. The LCD display will show C_{CT} . The clock time of the radio will set up automatically according to the RDS data received.
2. When the action is completed, C_{CT} will appear on the LCD display indicating the radio time is RDS clock time. The radio clock time will be valid for seventy two hours each time the radio time is synchronized with RDS CT.
3. When the radio is in standby mode, press and release the CT button to switch the standby display setting from Month-Day display to Year-Week display.

GB



Setting the alarm clock

Your K-200 radio has two alarms which can each be set to wake you to AM/FM radio, buzzer alarm or voice messages. The alarms may be set while the unit is in standby mode or while playing.

1. Before setting an alarm ensure that the clock time is set. Press and hold the Alarm 1 button to enter the alarm 1 setting.
2. The hour setting of alarm 1 will begin to flash. Rotate the Tuning control to select the required alarm hour, and press and release the Tuning control to confirm the setting. Rotate the Tuning control to select the required alarm minute, and press and release the Tuning control to confirm the setting.
3. Then the display will show the frequency options for the alarm.
The alarm options are as follows:
ONCE – the alarm will sound once
DAILY – the alarm will sound everyday
WEEKDAYS – the alarm will sound only on weekdays
WEEKENDS – the alarm will sound only at weekends
Press the Tuning control to confirm the setting. If you choose to set the alarm to Once you will also need to set the time using the Tuning control.

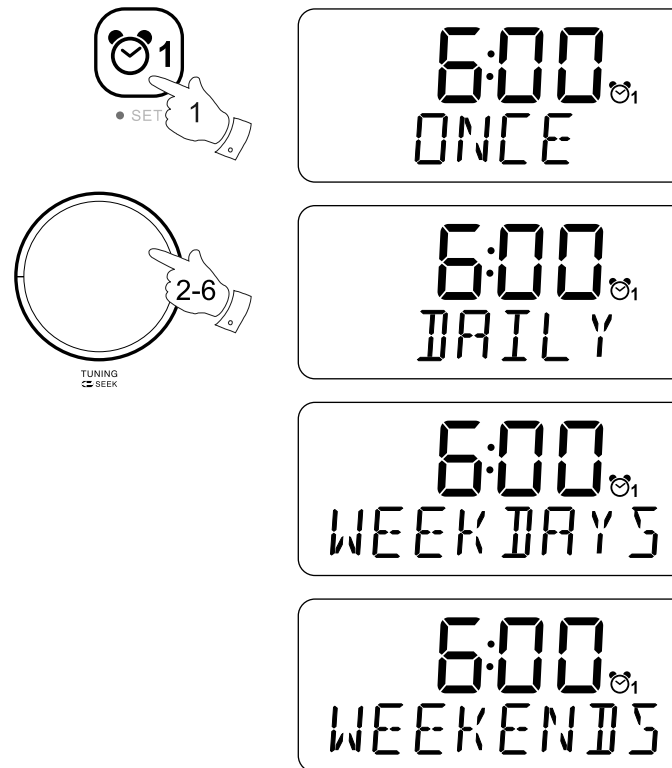

4. Rotate the Tuning control to choose the required alarm type, and then press and release the Tuning control to confirm the setting. The alarm can be set to buzzer, AM radio, FM radio or voice message (MSG1, MSG2 or MSG1+2). When radio mode is selected, the radio frequency and the preset number on the display will begin to flash. Rotate the Tuning control to adjust the required radio frequency or the required preset number for the radio alarm, then press and release the Tuning control to confirm the setting.

5. The alarm has now been set. The radio will beep once, and then will revert to normal display.

6. Rotate the Volume control to set the required volume.

7. Adjust the switch inside the battery compartment to set the required volume level for buzzer alarm. When the radio is set to wake by FM radio or voice message, the alarm volume will be the volume previously listened to.

Active alarms are shown using small alarm indicator on the display.

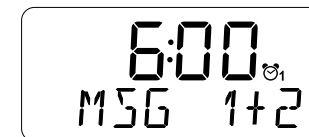
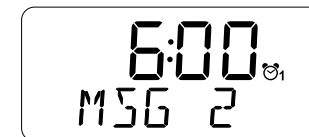
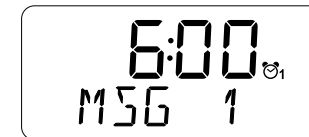
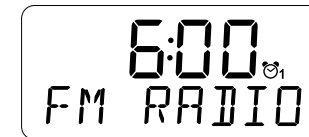
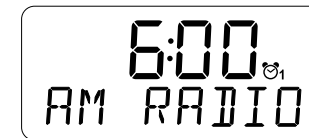
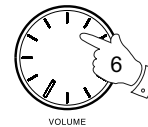

GB

When the alarm sounds

To cancel a sounding alarm, press and hold the Alarm 1 or Alarm 2 button until the radio beeps once, and the display shows "ALR OFF". And The LCD will return to normal display.

When the buzzer alarm activates, the alarm will start softly and gradually increase in level. It will sound for 1 minute and silence for 1 minute in repetition for 60 minutes unless cancelled.

The radio will sound non-stop at the selected time for up to 60 minutes for other alarm types.

Disabling/cancelling alarms

To disable an active alarm, either press and release the Standby button, or press and hold the according alarm button to cancel the alarm.

Snooze

1. When the alarm sounds, press any button other than the Standby button will silence the alarm for five minutes. "SNOOZE" will begin flashing on the display.
2. To cancel the snooze timer while the alarm is suspended, press the Standby button.

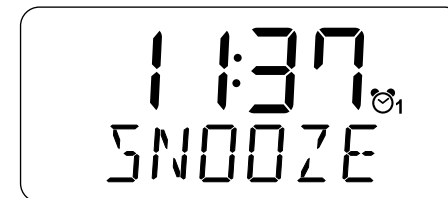
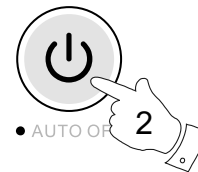

Auto Off Timer

Your radio can be set to turn off automatically after a preset time has elapsed. The Auto Off Timer setting can be adjusted between 15, 30, 45, 60, 90 and 120 minutes.

1. Press and hold the Standby button to enter the Auto Off Timer setting. "AUTO OFF 00" will show on the display.
2. Keep pressing the Standby button and the Auto Off Timer options will start switching on the display. Stop until the required Auto Off Timer setting appears on the display. The setting will be saved and the LCD will return to normal display.
3. Your radio will switch off automatically after the preset Auto Off Timer has elapsed.
The display will show "AUTO OFF" indicating an active Auto Off Timer.
4. To cancel the Auto Off Timer function before the preset time has elapsed, simply press and release the Standby button to turn the unit off manually.

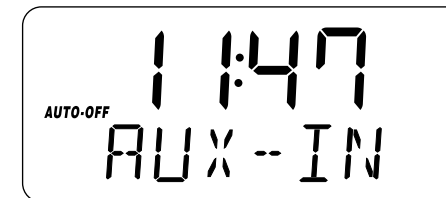
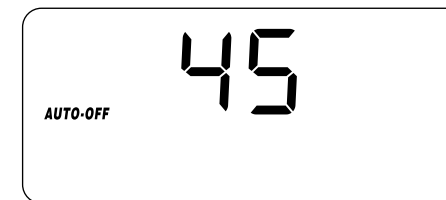
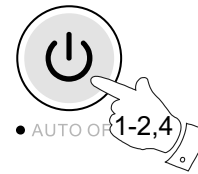

GB

Egg Timer function

1. Press and release the Egg timer button to enter the egg timer setting.
The egg timer setting will start flashing on the display.
2. Rotate the Tuning control to adjust the minute setting during 1 and 120 minutes with 1 minute interval. Press and release the Tuning control to finish the setting and the timer will start to countdown.
3. The egg timer icon  will flash on the display indicating an active egg timer, meanwhile the display will show the remaining minutes. To cancel the function when countdown is progressing, press and hold the Egg Timer button.
4. Rotate the Tuning control while the display shows the remaining time of countdown to adjust the required timer setting, then press and release the Tuning control to confirm the adjustment.

Note:

the digital receiver will sound for 3 minutes when an active timer finishes its countdown.

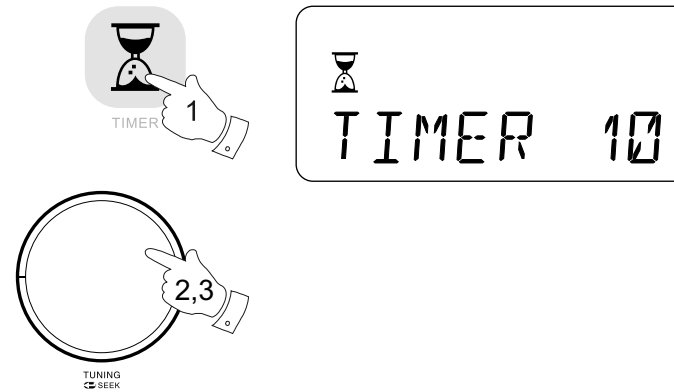



Display

Brightness control

The brightness of the display when the unit is in standby mode may be adjusted. If you use the unit in the bedroom, you may prefer a lower standby brightness level than the standard setting.

1. Press and release the Backlight button to adjust the current brightness level of the LCD display. The backlight level will change with 8 different illumination levels so that you can see the effect of the change.

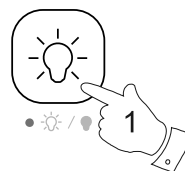

2. Stop when the desired backlight level is selected.

Moon LED

When using the radio, you can turn on the scenario LED at the bottom of the receiver for your better listening experience.

1. Press and hold the Light button to adjust the current scenario LED setting.
2. When the LED is on, press and hold the Light button to turn off the LED.
3. To switch and LED back on, press and hold the Light button again to turn on the LED.

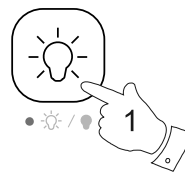

GB



Message function

The message function can record and playback with 2 sets of voice message for 30 seconds each.

1. Press and hold the Message button to record the voice up to 30 seconds length. The LED is lighted during recording and the display will show "RECORD". Press and release the Message button to pause the recording. After recording the LED will start flashing.
2. Press and release the Message button to playback the voice content, and the display will show "PLAYING". Press the message button to pause the message while it is being playback. The LED will stop flashing after message is played.
3. To overwrite an existing message, press and hold the Message button for 2 seconds to start recording a new message.
4. This Message button can operate in power on or off mode. In power on mode the receiver even in AM or FM as well as Aux-in will mute during the voice message processing.

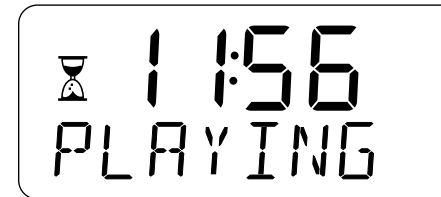

Software version

The software display cannot be altered and is just for your reference.

1. Make sure your radio is in power off mode (standby mode).
2. Press and hold the Tuning control knob until the setting of time format begins to flash.
3. Repeatedly press the Tuning control knob until the display shows the software version number on the display.

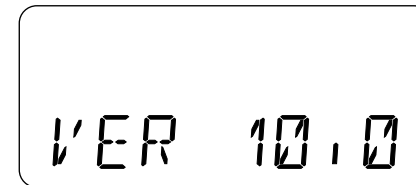
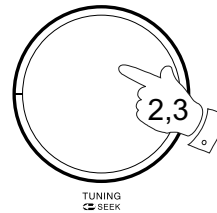

GB

Headphone socket

A 3.5mm stereo Headphone Socket is provided on the rear of your digital receiver for use with headphones. Inserting a plug automatically mutes the internal loudspeaker.

IMPORTANT:

Excessive sound pressure from earphones and headphones can cause hearing loss.

Auxiliary input socket

A 3.5mm stereo Auxiliary Input socket is provided on the rear of your radio to permit an audio signal to be fed into the unit from an external audio device such as iPod, MP3 or CD player.

1. Repeatedly press and release the Band button until "AUX IN" is displayed.
2. Connect an external audio source (for example, iPod, MP3 or CD player) to the Auxiliary Input socket.
3. Adjust the volume setting on your iPod, MP3 or CD player to ensure an adequate signal level from the player, and then use the Volume control on the digital receiver as needed for comfortable listening.

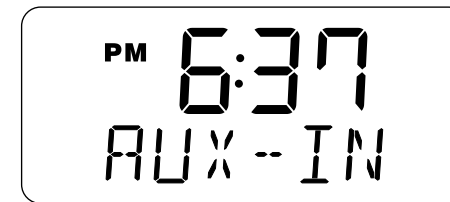
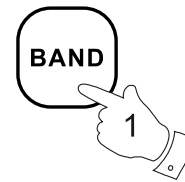

Specifications

Power Requirements

Mains AC 9V ~/ 0.7A
(AC to AC)

Frequency Range

FM: 87.5 – 108 MHz
AM: 520 – 1710 kHz (USA version)
522 – 1629 kHz (other version)

Battery

4 X 1.5V Size "C" / UM-2 / R14

Circuit Features

Loudspeaker	2.5" 8 ohm full range
Output Power	3 Watt / 1.5 Watt (batteries)
Headphone socket	3.5mm dia
Auxiliary socket	3.5mm dia
Aerial System	FM Wire aerial

GB



If at any time in the future you should need to dispose of this product please note that: Waste electrical products should not be disposed of with household waste. Please recycle where facilities exist. Check with your Local Authority or retailer for recycling advice. (Waste Electrical and Electronic Equipment Directive)