

ROBERTS

Sound for Generations

CRD-51

FM RDS/DAB Digital Clock Radio



DAB

Digital Audio Broadcasting

Please read this manual before use

Contents

<i>Controls</i>	2-3	<i>Clock display</i>	24
<i>Using your clock radio for the first time</i>	4	<i>Dimmer</i>	24
<i>Operating your clock radio - DAB</i>	5	<i>Display backlight</i>	24
<i>Selecting a station - DAB</i>	6	<i>Headphone socket</i>	25
<i>Display modes - DAB</i>	7	<i>Factory reset</i>	26
<i>Finding new stations - DAB autoscans</i>	8	<i>Software version</i>	27
<i>Manual tuning - DAB</i>	9	<i>General</i>	28
<i>Dynamic range control (DRC)</i>	10	<i>Specifications</i>	28
<i>Operating your radio - FM autotune</i>	11	<i>Circuit features</i>	28
<i>Operating your radio - FM manual tune</i>	12	<i>Guarantee</i>	rear cover
<i>Display modes - FM</i>	13		
<i>Presetting stations</i>	14		
<i>Recalling a preset station</i>	15		
<i>Setting alarm times</i>	16-18		
<i>To view alarm times</i>	19		
<i>Cancelling alarms</i>	19		
<i>Snooze function</i>	20		
<i>To set snooze time</i>	20		
<i>Sleep function</i>	21		
<i>Setting the clock</i>	22		

Controls (Top)

1. Volume Up / Down buttons
2. Dimmer button
3. On / Off button
4. Sleep button
5. Alarm / Clock button
6. FM / DAB button
7. Snooze button
8. Preset button
9. Menu / Display button
10. Select button
11. Tuning Up / Down buttons

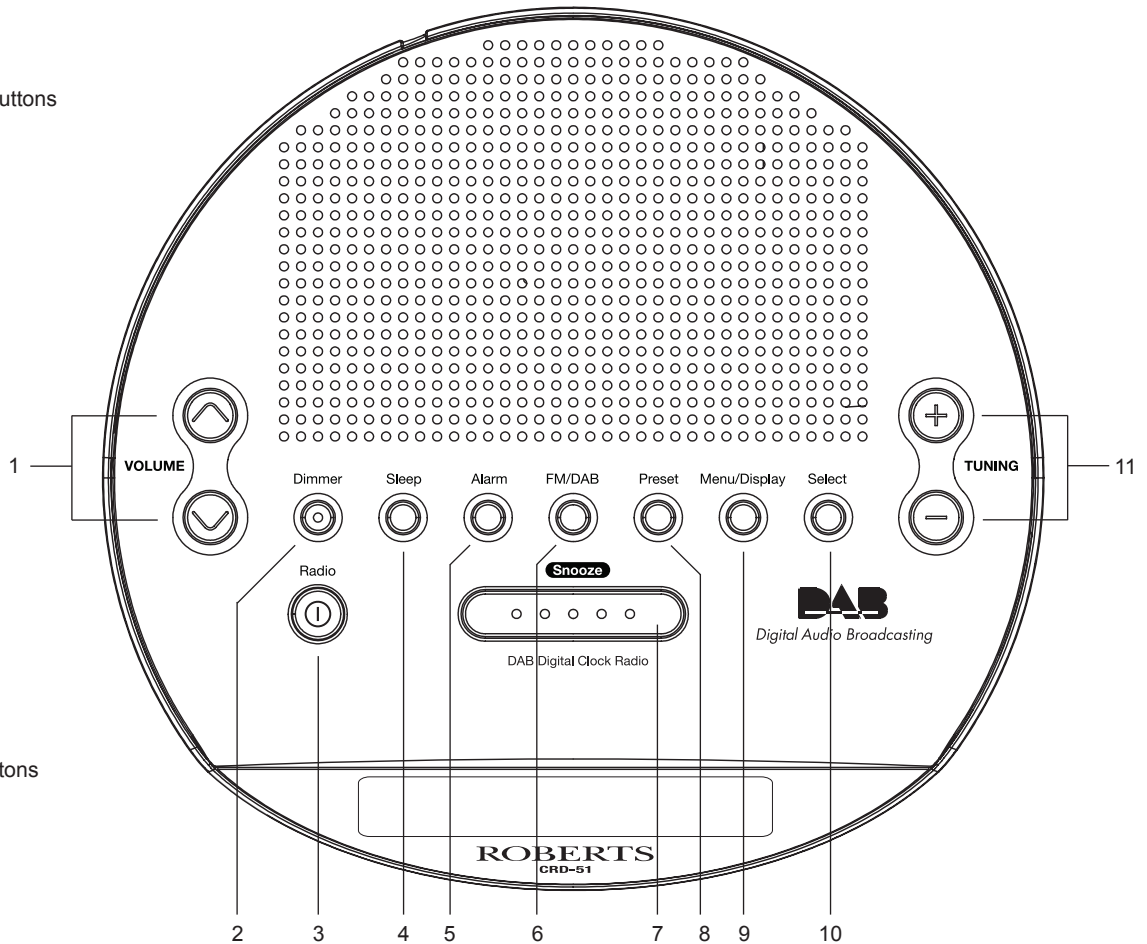

If you need any further advice, please call our Technical Helpline on :-
020 8758 0338 (Mon-Fri)

Controls (left side)

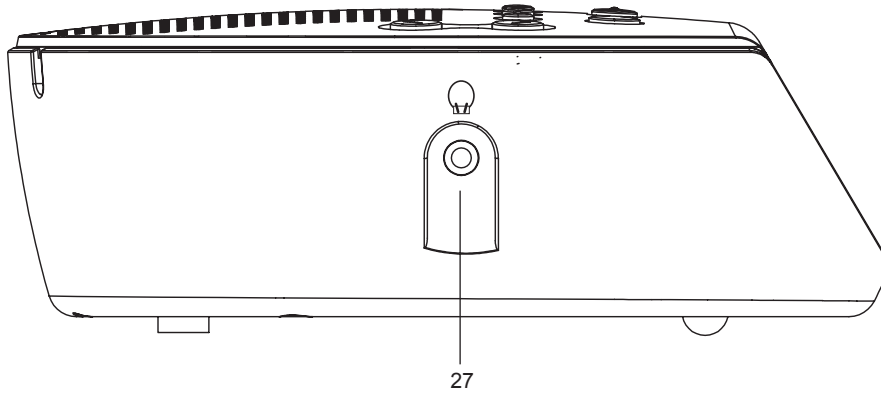

24. Headphone socket

Using your clock radio for the first time

1. Place your clock radio on a flat surface.
2. Fully extend the wire aerial located on the rear of your clock radio. Place the wire antenna so that it is as straight as possible extending either above or below the radio.
3. Plug the mains lead into a wall socket and switch on the wall socket. the display will show "ROBERTS" and after few seconds a station scan search will be performed automatically. The display will show progress of the station search e.g. ">>>> 18". The number on the right of the display is the number of stations that have been found.
The display will then show "SET CLOCK", after a short time the current time will appear on the display.
4. If no stations are found, "NO CLOCK" will be displayed. It may necessary to relocate your clock radio to a position giving better reception. You should then carry out an autoscan to find stations as described on page 8.

IMPORTANT: The mains plug is used as the means of connecting the radio to the mains supply. The mains socket used for the radio must remain accessible during normal use. In order to disconnect the radio from the mains completely, the mains plug should be removed from the mains socket outlet completely.

Characters appearing on the LCD display indicate that the radio is connected to and powered from the mains supply.

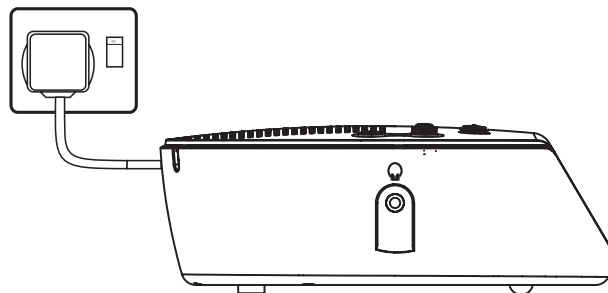

Operating your clock radio - DAB

1. Press the **On/off button** to switch on your clock radio. The display will show "TUNING" for a few seconds.
2. If your clock radio has been used before, the last used station will be selected.
3. The first station in the list of stations found will be played. The display will show the station name on the display.
4. If no signals are found "OFF AIR" will be displayed and it may be necessary to relocate your clock radio to a position giving better reception. You should then carry out an autoscans to find stations as described on page ??.

Radio



Selecting a station – DAB

1. The display shows the name of the station currently selected.
2. Press the **Tuning up** or **down buttons** to step through the list of available stations.
3. When the desired station name appears on the display, press the **Select button** to select the station. The display will show "TUNING" while your radio finds the new station.
4. Press the **Volume Up or Down buttons** to set the required volume level.

Note: If after selecting a station the display shows "OFF AIR", it may be necessary to relocate your radio to a position giving better reception.

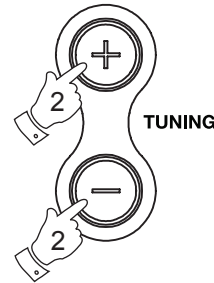

Select



VOLUME

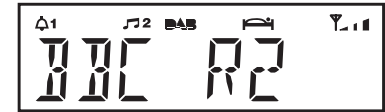
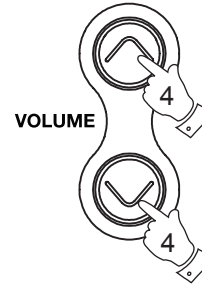

Display modes - DAB

Your radio has seven display modes:-

1. Press the **Display button** to cycle through the various modes.
 - a. Scrolling text Displays scrolling text messages such as artist/track name, phone in number, etc.
 - b. Programme type Displays type of station being listened to e.g. Pop, Classic, News, etc.
 - c. Multiplex Name Displays name of multiplex to which current station belongs.
 - d. Time Displays current time.
 - e. Date Displays current date
 - f. Frequency and Channel Displays frequency and channel number.
 - g. Bit rate Displays the digital bit rate.
 - h. Signal error Displays the bit error rate the for station being listened to.

Menu/Display

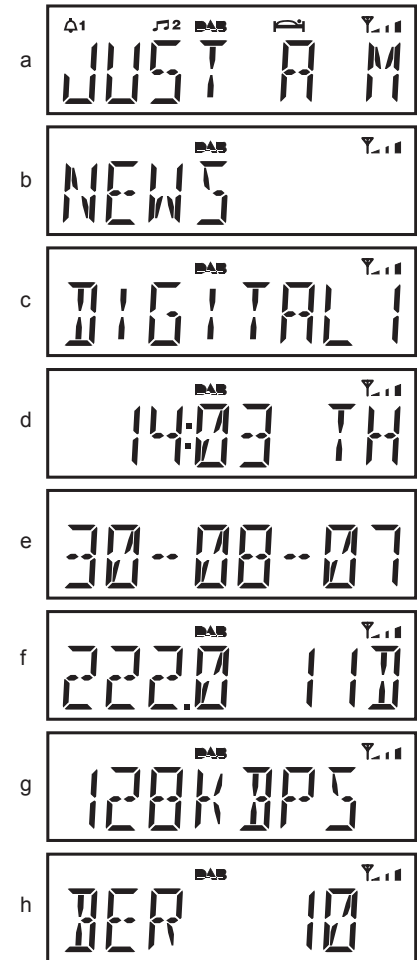

Finding new stations - DAB autoscan

As time passes new stations may become available. To find new stations proceed as follows:-

1. Press and hold down the **Menu/Display button** until the display shows "MANUAL".
2. Press the **Tuning Up or Down buttons** until the display shows "LOC SCAN".
3. Press and release **Select button**. Your radio will perform a scan of the UK DAB frequencies. As new stations are found, the station counter on the right-hand side of the display will increase and stations will be added to the list.
4. To carry out a full scan of the entire DAB Band III frequencies, press and hold down the **Menu/Display button** until the display shows "MANUAL".
5. Press the **Tuning Up or Down buttons** until the display shows "FULLSCAN".
6. Press and release **Select button**. Your radio will perform a full scan of the DAB frequencies.. As new stations are found, the station counter on the right-hand side of the display will increase and stations will be added to the list.

Menu/Display

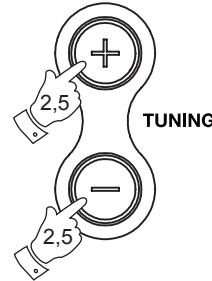

Select



Manual tuning - DAB

Manual tuning allows you to tune and add the various DAB Band III channels to your station list. UK DAB stations are located in the range 11B to 12D. This function can also be used to assist the positioning of the antenna or your clock radio to obtain the optimum reception for a specific channel / frequency.

1. Press and hold the **Menu/Display button** for 2 seconds, the display will show "MANUAL".
2. Press and release the **Select button**.
3. Press the **Tuning Up** or **Down buttons** to select the required DAB channel.
4. Press and release the **Select button** to return to normal service.

Menu/Display



Select

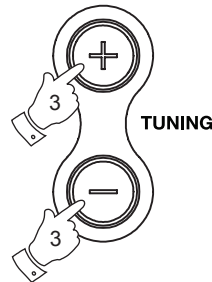

Dynamic range control (DRC)

DRC can make quieter sounds easier to hear when your radio is used in a noisy environment.

There are three levels of compression:

DRC 0	No compression applied. (default)
DRC 1	Maximum compression applied
DRC 1/2	Medium compression applied.

1. Press the **On/Off button** to switch on your clock radio.
2. Press the **FM/DAB button** to select the DAB band
3. Press and hold down the **Menu/Display button** until the display shows "MANUAL"
4. Press the **Tuning up or down buttons** until "DRC VAL" appears on the display. then press Select button. The display will show the current DRC value.
5. Press the **Tuning up or down buttons** to select the required DRC setting. Default is 0.
6. Press and release the **Select button** to confirm the setting. The display will return to radio mode.

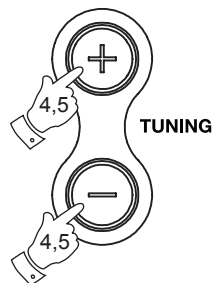
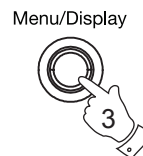

Operating your radio – FM autotune

1. Fully extend the wire aerial located on the rear of your clock radio. Place the wire antenna so that it is as straight as possible extending either above or below the radio.
2. Press the **On/Off button** to switch on your radio.
3. Press the **FM/DAB button** to select the FM band.
4. Press and hold down the **Tuning Up** or **Down buttons** until the frequency in the display begins to change. Your radio will scan the FM waveband, stopping each time it finds a station of sufficient strength.
5. After a few seconds, the display will update and show station name if RDS information is available.
6. To find other stations, Press the **Tuning Up** or **Down** buttons as before.
7. When the end of the waveband is reached, your radio will recommence tuning from the opposite end of the waveband.
8. Press the **Volume Up** or **Down buttons** to set the required volume level.
9. To switch off your clock radio press **On/Off button**.

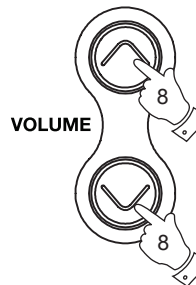
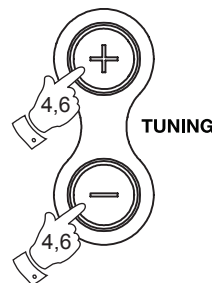
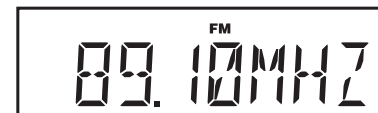

Operating your radio – FM manual tune

1. Fully extend the wire aerial located on the rear of your clock radio. Place the wire antenna so that it is as straight as possible extending either above or below the radio.
2. Press the **On/Off button** to switch on your radio.
3. Press the **FM/DAB button** to select the FM band.
4. Press the **Tuning Up** or **Down buttons** to tune to a station. The frequency will change in steps of 50 kHz.
5. Press the **Volume Up** or **Down buttons** to set the required volume level.
6. To switch off your clock radio press **On/Off button**.

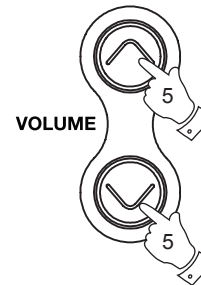
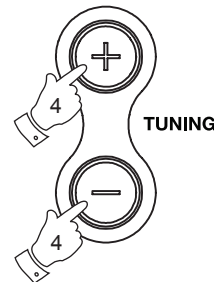

Display modes – FM

Your radio has four display modes for FM listening:-

The Radio Data System (RDS) is a system in which inaudible digital information is transmitted in addition to the normal FM radio programme. RDS offers several useful features. The following are available on your clock radio:-

1. Press the **Display/Menu button** to cycle through the various modes.

a. Frequency Displays the frequency of the station being listened to.

b. Scrolling text Displays scrolling text messages such as artist/track name, phone in number, etc.

c. Programme Type Displays type of station being listened to e.g. Pop, Classic, News, etc.

d. Time Displays current time.

e. Date Displays current date

Menu/Display



Presetting stations

There are 20 memory presets, 10 for DAB and 10 for FM.

1. Press the **On/Off button** to switch on the radio.
2. Press the **FM/DAB button** to select the desired waveband.
3. Tune to the required station as previously described.
4. Press and release the **Preset button**. The display will show “Empty 1” if there are no preset stations stored.
5. Use the **Tuning up or down buttons** to select the desired preset station number under which you wish to store the station
6. Press and hold down the **Preset button** until the display shows e.g. “P1 saved”. The station will be stored under the chosen preset button. Repeat this function for the remaining presets.
7. Stations stored in preset memories may be overwritten by following the above procedure.

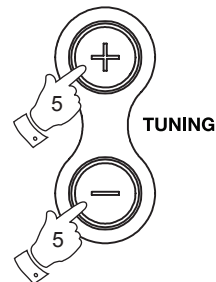

Recalling a preset station

1. Press the **On/Off button** to switch on the radio.
2. Press the **FM/DAB button** to select the desired waveband.
3. Press the **Preset button**.
4. Press the **Tuning Up or down buttons** to select the desired preset station.
5. Press the **Select button**. Your clock radio will tune to the preset station stored in the preset memory.

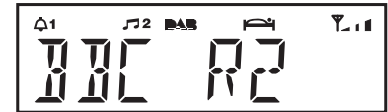
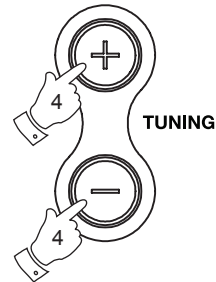

Setting alarm times

Your clock radio has two alarms which can be set to wake you to either radio or beep type alarm. Each alarm can be set to sound once, daily, weekdays and weekends. The alarms only can be set when your clock radio is switched on.

Note : If no buttons are pressed for 5 seconds, your clock radio will exit the alarm setup.

1. Press the **On/Off button** to switch on your clock radio.
2. Press the **Alarm button** once. The display will show "SET ALM".
3. Press **Select button** to enter the alarm setup. "Alarm 1" flashes.
4. Press the **Tuning up or down buttons** to select the desired alarm number 1-2.
5. Press **Select button** to enter to alarm type mode.
6. Press **Tuning up or down buttons** to select WAKE >DAB, WAKE >FM or WAKE >BUZ.
7. Press **Select button** to enter to activate mode, press **Tuning up or down buttons** to select ON or OFF.

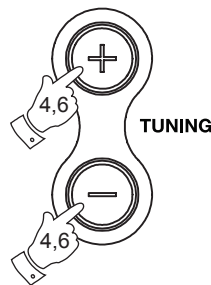

Setting alarm times - cont.

7. Press the **Select button** to enter the alarm hour. The display will show the current time in 24 hour format. The hour digit will be selected.

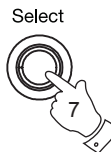

8. Press the **Tuning up or down buttons** to set the correct hour.

9. Press **Select button** to enter the alarm minutes. The minute digit will be selected.

10. Press the **Tuning up or Down buttons** to set the correct minute.

11. Press **Select button** to enter the alarm day option. Your clock radio can be set to sound once, daily, weekdays and weekends.

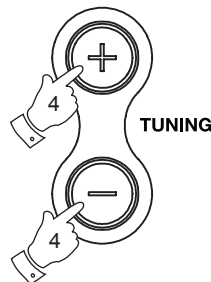

- | | |
|----------|--------------------------------|
| Once | - Will sound at one time only. |
| Daily | - Will sound every day. |
| Weekdays | - Will sound only on weekdays. |
| Weekends | - Will sound only on weekends. |

12. Press the **Tuning up or down buttons** to select either once, daily, weekdays or weekends.

13. If selecting alarm to once, you will need to set the year, month and day options as described below:

14. Press the Select button to enter the alarm year option



Setting alarm times - cont.

15. Press the **Tuning up** or **down buttons** to select the correct year

16. Press the **Select button** to enter the alarm month option

17. Press the **Tuning up** or **down buttons** to select the correct month

18. Press the **Select button** to enter the alarm day option

19. Press the **Tuning up** or **down buttons** to select the correct day.

20. Press the **Select button** to confirm alarm settings and return to normal radio mode.

21. Radio alarms are indicated in the display by the 🎵 symbol and the corresponding alarm number. Buzzer alarms are indicated in the display by the 🔔 symbol and the corresponding alarm number.

Note: The alarms will not sound if the alarms have not been activated and set to the ON position. When your clock radio is set to wake you by the radio alarm, your clock radio will switch on to the last used station.

Select



18. Press the **Select button** to enter the alarm day option

19. Press the **Tuning up** or **down buttons** to select the correct day.

20. Press the **Select button** to confirm alarm settings and return to normal radio mode.

21. Radio alarms are indicated in the display by the 🎵 symbol and the corresponding alarm number. Buzzer alarms are indicated in the display by the 🔔 symbol and the corresponding alarm number.

Note: The alarms will not sound if the alarms have not been activated and set to the ON position. When your clock radio is set to wake you by the radio alarm, your clock radio will switch on to the last used station.

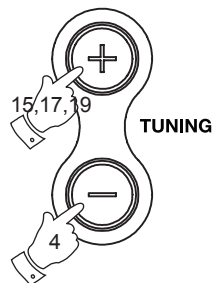

To view alarm time

1. Press the **Alarm button** to enter the alarm setup.
2. Press the **Select button**, then press the **Tuning up** or **down buttons** to view alarms 1 or 2.
3. Press the **Select button** to cycle through the various settings for the chosen alarm.

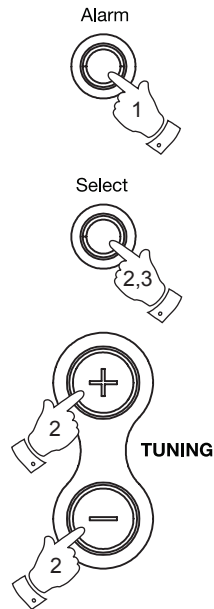

Cancelling alarms

1. Whilst an alarm is sounding, it can be cancelled by pressing the On/Off button.

Snooze function

When the radio or buzzer alarm sounds, pressing the **Snooze button** will silenced the alarm for the selected number of minutes. The Snooze setting can be adjusted between 5 and 20 minutes in 5 minute increments. Default setting is 5 minutes.

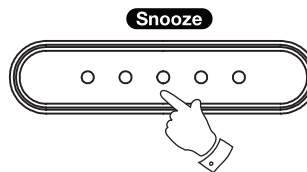

The radio or buzzer alarms can be silenced for a set time by pressing the **Snooze button**.

To set the snooze time

1. To set the snooze to the desired snooze time, press the **Alarm button** to enter the menu setup.
2. Press the **Tuning up** or **down buttons** until "Snooze" appears on the display. Press and release the **Select button**. "Snooze 05" will be displayed.
3. Press the **Tuning up** or **down buttons** to select the desired snooze setting 20>15>10>5 minutes.
4. Press the **Select button** to select desired time. The radio will exit the menu options and return to radio play mode.

Alarm

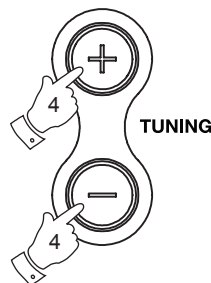

Select



Sleep function

Your clock radio can be set to turn off after a preset time has elapsed. The sleep setting can be adjusted between 5 and 90 minutes in 5 minute increments.

1. To set the desired sleep time, press the **Sleep button** to enter the sleep setup.
2. Press the **Tuning up** or **down buttons** to adjust the sleep countdown time - ranging from 5 - 90 and Off.
3. Press **Select button** to confirm the setting.
4. Your clock radio will switch off after the preset sleep time has elapsed.
5. To cancel the sleep function before the sleep time has elapsed press the **On/Off button**

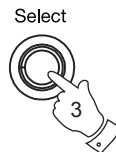
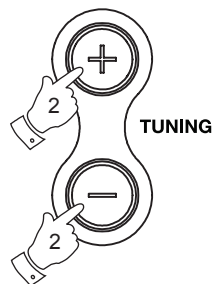

Setting the clock

Normally your clock radio will set its clock automatically via the DAB signal. If no DAB signal is available and you need to set the time manually, please follow the procedure shown below.

Note: The DAB signal will always override any manual time setting.

1. Press and hold down the **Menu/Display button** until the display shows "MANUAL"
2. Press the **Tuning up or down buttons** until "CLOCK" appears on the display.
2. Press **Select button** to enter the clock set menu.
3. Press the **Tuning up or down buttons** until the display shows "MANU CLK"
4. Press the **Select button** to enter the set hour option
5. Press the **Tuning up or down buttons** to select the correct hour.
6. Press the **Select button** to enter the set minute option
7. Press the **Tuning up or down buttons** to select the correct minute.
8. Press the **Select button** to enter the set year option.
9. Press the **Tuning up or down buttons** to select the correct year

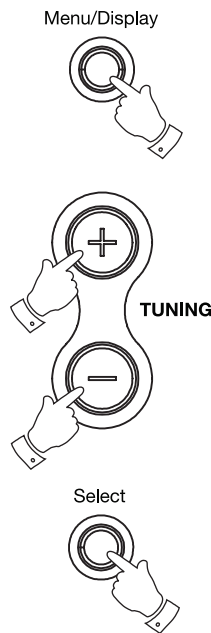

Setting the clock cont.

10. Press the **Select button** to enter the set month option.
11. Press the **Tuning up or down buttons** to select the correct month.
12. Press the **Select button** to confirm time settings and return to normal radio mode.

To return to Auto clock set mode

1. Press and hold down the **Menu/Display button** until the display shows "MANUAL"
2. Press the **Tuning up or down buttons** until "CLOCK" appears on the display.
3. Press **Select button** to enter the clock set menu.
4. Press the **Tuning up or down buttons** until the display shows "AUTO CLK"
5. Press the **Select button** to confirm time settings and return to normal radio mode.

Menu/Display

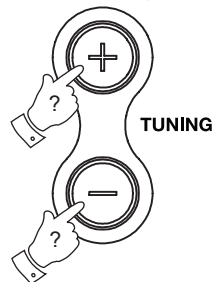

Select



Note: If you select "AUTO CLK" the current time received will be displayed.
If no DAB signal is found, "NO DABCK" will be displayed

Clock display

1. When your clock radio is in standby mode displaying current time the date can be displayed by pressing the **Menu/Display button**. After 10 seconds the display will return to showing current time

Menu/Display



Dimmer

1. In order to adapt the intensity of the display to suit the ambient room lighting, press Dimmer button on the top of your clock radio to select the dimmer brightness from High-Mid-Low and Off.

Dimmer

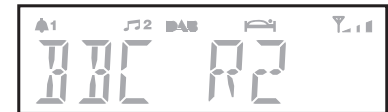
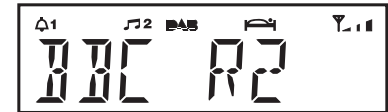

Display Backlight

1. In order to view the display when the display backlight is set to off, you can press any button (apart from the On/Off button or Dimmer button) to switch on the backlight. The display will light up for 10 seconds before returning to off.

Headphone socket

A 3.5mm Headphone socket located on the left side of your clock radio is provided for use with either headphones or an earpiece. Inserting a plug automatically mutes the internal loudspeaker.

Important: Excessive sound pressure from the earphones or headphones can cause hearing loss.

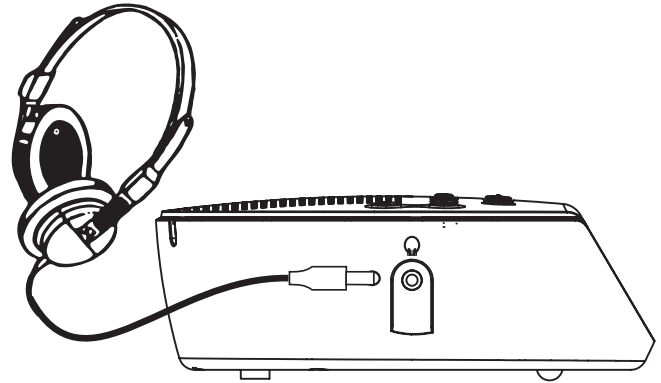

Factory Reset

If your radio fails to operate correctly, or some digits on the display are missing or incomplete, carry out the following procedure.

1. Press and hold down the **Menu/Display** button for 2 seconds,
2. Press the **Tuning up or down buttons** until “FACTORY” appears on the display, press the **Select button**, the display shows “RESET” and then press **Select button** again.
3. A full reset will be performed, the station list and presets will be erased. The display will show “RESETTING” followed by “ROBERTS” after few seconds a station scan search will be performed automatically. The display will show progress of the station search e.g. “>>>> 18”. The number on the right of the display is the number of stations that have been found.

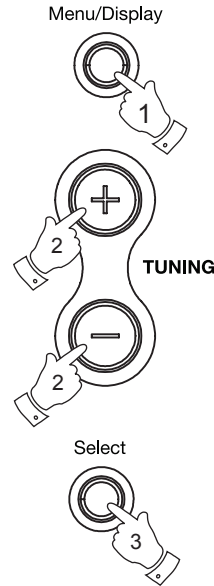

Software Version

This is provided as a reference when servicing is required.

1. Press the **On/Off button** to turn on the radio.
2. Press and hold the **Menu/Display button**.
3. Press the **Tuning up or down button** until the software version of the unit appears on the display.

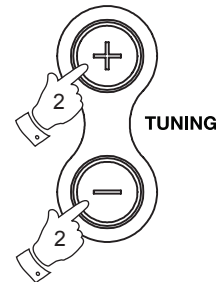
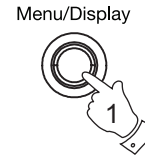

General

Do not allow your clock radio to be exposed to water, steam or sand. Do not leave your radio where excessive heat could cause damage such as in a parked car where the heat from the sun can build up even though the outside temperature may not seem too high.

- The name plate is located on the bottom of the unit.

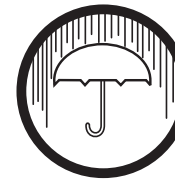

Specifications

Power Requirements

AC adaptor AC 230 volts, 50Hz  only

Frequency Coverage

DAB	174.928 - 239.200MHz
FM	87.50 - 108 MHz

Circuit features

Loudspeaker	66mm diameter
Output Power	500 mW
Headphone socket	3.5mm dia

Aerial System

DAB and FM	Wire antenna
------------	--------------

The Company reserves the right to amend the specification without notice

If you need any further advice, please call our Technical Helpline on :-
020 8758 0338 (Mon-Fri)

Mains supply

The CRD51 will operate from a supply of AC 230 volts, 50Hz \sim only.

DO NOT cut off the mains plug from this equipment. If the plug fitted is not suitable for the power points in your home or the cable is too short to reach a power point, then obtain an appropriate safety approved extension lead or adaptor. If in doubt consult your dealer.

If nonetheless the mains plug is cut off, remove the fuse and dispose of the plug immediately to avoid a possible shock hazard by inadvertent connection to the mains supply.

If this product is not supplied with a mains plug, or one has to be fitted, then follow the instructions given below:

IMPORTANT. DO NOT make any connection to the larger terminal which is marked with the letter E or by the safety earth symbol \perp or coloured Green or Green-and-yellow.

The wires in the mains lead are coloured in accordance with the following codes :-

BLUE - NEUTRAL

BROWN - LIVE

The wire coloured BLUE must be connected to the terminal marked N or coloured BLACK.

The wire coloured BROWN must be connected to the terminal marked L or coloured RED.

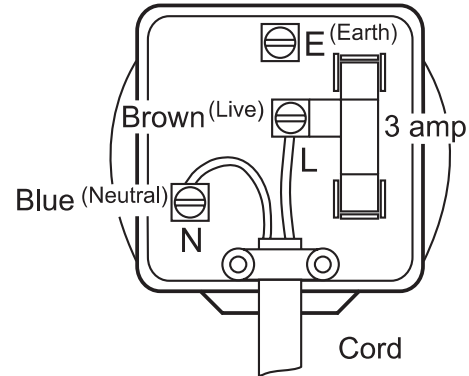

Fuse

When replacing the fuse only a 3A ASTA approved to BS1362 type should be used and be sure to re-fit the fuse cover.

IF IN DOUBT - CONSULT A QUALIFIED ELECTRICIAN.

Replacement fuse holders are available from Roberts Radio Technical Services at the address shown on the rear of this manual.

Guarantee

This instrument is guaranteed for twelve months from the date of delivery to the original owner against failure due to faulty workmanship or component breakdown, subject to the procedure stated below. Should any component or part fail during this guarantee period it will be repaired or replaced free of charge.

The guarantee does not cover:

1. Damage resulting from incorrect use.
2. Consequential damage.
3. Receivers with removed or defaced serial numbers.

Procedure:

Any claim under this guarantee should be made through the dealer from whom the instrument was purchased. It is likely that your Roberts' dealer will be able to attend to any defect quickly and efficiently but should it be necessary the dealer will return the instrument to the Company's service department for attention. In the event that it is not possible to return the instrument to the Roberts' dealer from whom it was purchased, please contact Roberts Radio Technical Services at the address shown on the rear of this manual.

These statements do not affect the statutory rights of a consumer.



Issue 1

ROBERTS RADIO TECHNICAL SERVICES

97-99 Worton Road

Isleworth Middlesex

TW7 6EG

Technical Helpline :- 020 8758 0338 (*Mon-Fri during office hours*)

Website: <http://www.robertsradio.co.uk>

