



MITEL

# COMMUNICATIONS DIRECTOR PLATFORM

ACD AGENT GUIDE  
FOR THE MITEL 5320/5330/5340 IP PHONES



**NOTICE**

The information contained in this document is believed to be accurate in all respects but is not warranted by Mitel Networks™ Corporation (MITEL®). The information is subject to change without notice and should not be construed in any way as a commitment by Mitel or any of its affiliates or subsidiaries. Mitel and its affiliates and subsidiaries assume no responsibility for any errors or omissions in this document. Revisions of this document or new editions of it may be issued to incorporate such changes.

No part of this document can be reproduced or transmitted in any form or by any means - electronic or mechanical - for any purpose without written permission from Mitel Networks Corporation.

ACD Agent Guide  
for the Mitel 5320/5330/5340 IP Phones

July 2012

®,™ Trademark of Mitel Networks Corporation  
© Copyright 2012, Mitel Networks Corporation  
All rights reserved

---

<b>ABOUT THIS GUIDE .....</b>	<b>1</b>
<b>WHAT IS AUTOMATIC CALL DISTRIBUTION (ACD)? .....</b>	<b>1</b>
<b>ABOUT YOUR MITEL 5320 IP PHONE .....</b>	<b>2</b>
<b>ABOUT YOUR MITEL 5330/5340 IP PHONES .....</b>	<b>3</b>
Elements of Your Phone.....	5
Ring/Message Indicators .....	6
For Users on Resilient MCD Systems .....	6
Mitel Line Interface Module.....	6
<b>TIPS FOR YOUR COMFORT AND SAFETY .....</b>	<b>7</b>
Don't cradle the handset!.....	7
Protect your hearing .....	7
Adjust the viewing angle .....	7
<b>ACD AGENT FEATURES AND CAPABILITIES .....</b>	<b>8</b>
What are Agent Groups?.....	8
About ACD Agent Hot Desking.....	8
ACD Express Agents .....	9
Logging In.....	10
Displaying Agent Log-In Information.....	11
Logging Out.....	11
Answering Calls.....	12
Using the Auto Answer Feature.....	12
Activating Auto Answer.....	12
Deactivating Auto Answer.....	12
Using a Headset .....	13
Installing a Headset (no Feature Control Switch).....	13
Handling Calls with a Headset (no Feature Control Switch): .....	14
Installing a Headset with Feature Control Switch.....	14
Handling Calls with a Headset (with Feature Control Switch): .....	15
Using and Canceling the Work Timer .....	15

Taking a Break from Calls (Make Busy Feature).....	16
Activating Make Busy .....	16
Removing Make Busy.....	16
Queue Threshold Alert.....	16
Group Presence.....	17
Visual Indications.....	18
Audible Indications.....	18
Displaying Queue Status .....	19
Personal Directory .....	20

## About this Guide

This guide describes operation of the Automatic Call Distribution (ACD) Feature Package on Mitel Networks IP Phones.

For operation of other features associated with a Mitel Networks IP Phone (some of which will work in conjunction with ACD), refer to the set guide.

## What is Automatic Call Distribution (ACD)?

The Automatic Call Distribution Feature Package is offered by the Mitel<sup>®</sup> Communications Director Platform (MCD). ACD is a method of switching large volumes of similar calls directly to a selected group of extensions (Agents). All calls are distributed equally among the Agents. The calls are all of a similar nature, and the Agents are trained/equipped to provide the particular information or service the caller is requesting.

Typical examples of ACD applications include:

- airline reservation offices
- telephone order desks for large retail stores
- customer service departments of telephone or cable T.V. companies.

When there are more incoming calls than available Agents, the calls may be routed to recordings. The recordings can advise the callers that all Agents are busy, and that an Agent will answer as soon as possible. Various recordings may be provided to inform the caller as to call progress if an Agent is not accessed immediately, or to advise the caller of information the Agent will require when connection is established.

The MCD distributes calls to the Agents in so that all Agents are given an equal workload. A Supervisor usually oversees the operation, monitors the activity of the Agents, and handles any situations that may arise.

## About Your Mitel 5320 IP Phone

The Mitel® 5320 IP Phone is full-feature, dual port, dual mode enterprise-class telephone that provides voice communication over an IP network. It features a large graphics display (160 x 320) and self-labeling keys. The 5320 IP Phone offers seven programmable multi-function keys for one-touch feature access. It provides ten fixed feature keys for convenient access to features such as Conferencing, Redial, and many customizable user settings as well as navigational keys to access various screens and application layers. The 5320 also features a Mitel Unified Communicator® (UC) Express application, which is a PC-based desktop programming tool that allows you to easily configure your phone from your Personal Computer (PC).

The 5320 IP Phone supports Mitel Call Control (MiNet) protocol and session initiated protocols (SIP). It also supports Hot Desking and Clustered Hot Desking as well as Resiliency. The 5320 phone is ideal for executives and managers, and can be used as an ACD Agent or Supervisor Phone, as well as a Teleworker Phone.



The 5320 IP Phone

## About Your Mitel 5330/5340 IP Phones

The Mitel 5330 and 5340 IP Phones are full-featured, dual port, dual mode enterprise-class telephones that provide voice communication over an IP network. They both feature a large graphics display (160 x 320) and self-labeling keys. The 5330 IP Phone offers 24 programmable multi-function keys; the 5340 IP Phone offers 48 programmable multi-function keys for one-touch feature access. Both phones provide ten fixed feature keys for convenient access to features such as Conferencing, Redial, and many customizable user settings as well as navigational keys to access various screens and application layers. The 5330 and 5340 IP Phones also feature a PC Companion application, which is a PC-based desktop programming tool that allows you to easily configure your phone from your Personal Computer (PC).

The 5330 and 5340 IP Phones support Mitel Call Control (MiNet) protocol and session initiated protocols (SIP). Both phones support the Line Interface Module and 5310 IP Conference Unit. Additionally, they support Hot Desking and Clustered Hot Desking as well as Resiliency. The 5330/5340 phones are ideal for executives and managers, and can be used as an ACD Agent or Supervisor Phone, as well as a Teleworker Phone.



The 5330 IP Phone













NN0218

The 5340 IP Phone



## Elements of Your Phone

Feature	Function
1) Display	Provides a large, high-resolution viewing area that assists you in selecting and using phone features.
2) Ring/Message Indicator	Flashes to signal an incoming call and to indicate a message waiting in your voice mailbox.
3) Volume, Speaker and Mute Controls	<p>Provide the following audio control capability:</p> <p> (UP) and  (DOWN) provide volume control for the ringer, handset, and handsfree speakers.</p> <p> (SPEAKER) enables and disables Handsfree mode.</p> <p> (MUTE) enables Mute, which allows you to temporarily turn your phone's handset, headset or handsfree microphone off during a call.</p>
4) Fixed Function Keys	<p>Give you access to the following phone functions:</p> <p> (APPLICATIONS): provides access to menus for your phone's applications and settings.</p> <p> (CANCEL): ends a call when pressed during the call, and, when you are programming the phone, eliminates any input and returns to the previous menu level.</p> <p> (REDIAL): calls the last number dialed.</p> <p> (HOLD): places the current call on hold.</p> <p> (TRANS/CONF): initiates a call transfer or establishes a three-party conference call.</p> <p> (MESSAGE): provides access to your voice mailbox and flashes to notify you of messages waiting in your voice mailbox. Note: The Ring/Message indicator also flashes when messages are waiting.</p>
5) Keypad	Use to dial.
6) Navigation Page Keys	Use to display additional pages of information. The 5320 and 5330 has two page navigation keys: Back and Next. The 5340 has three page navigation keys: Back, Next, and Home.
7) Programmable Feature Keys and Softkeys.	<p>The 5320 provides 7 self-labeling keys that can be programmed as speed call keys, fixed function keys, hard keys, applications, or line appearance keys, according to your communication needs. On your home page, the bottom left feature key is always your Prime Line key. The top three keys are softkeys.</p> <p>The 5330 provides 24 self-labeling keys and the 5340 provides 48 self-labeling keys that can be programmed as speed call keys, fixed function keys, hard keys, applications, or line appearance keys, according to your communication needs. On your home page, the bottom right feature key is always your Prime Line key on a 5340 IP Phone; and the bottom left feature key is always your Prime Line key on the 5330 IP Phone. The top three keys are softkeys.</p>
8) Handsfree Speaker	Provides sound for Handsfree calls and background music.
9) Handset	Use for handset calls. If you are in headset or handsfree mode, you do not need to use the handset.

## Ring/Message Indicators

When indicator is	it means that
Flashing rapidly	Your phone is ringing
Flashing slowly	A message or callback message is waiting at your phone
On	Your phone is ringing another phone
Off	Your phone is idle, or you are on a call

## For Users on Resilient MCD Systems

If during a call, you hear a beep repeated every 20 seconds it means that your phone is switching to a secondary MCD system. The call continues and there is a change in the operation of some keys and features on your phone. Normal operation resumes when your phone switches back to the primary system. If your phone is idle and switched to the secondary system, you'll see a flashing rectangle on the display. The rectangle remains until the switch to the primary system is complete.

If the phone fails over to the secondary MCD, you have access to your mailbox on the secondary MCD only if your Administrator has programmed a mailbox for you.



### Notes:

- The mailbox on the secondary MCD will not contain the same messages as the mailboxes on the primary MCD. Any preferences that are voice mail related are not carried from the primary MCD to the secondary MCD. These preferences must be set on both MCDs.
- The Settings application does not support resiliency. Your logs, contact information and any Settings on the primary MCD will not be carried from the primary MCD to the secondary MCD.

## Mitel Line Interface Module

The Line Interface Module is an optional device that adds an analog phone line (POTS) capability to your phone. If Emergency Call Routing is not programmed on your MCD, you must use the Line Interface Module to dial emergency calls. For more information on emergency number dialing, refer to *Emergency Calls*. If you have a Line Interface Module connected to your phone, all programming of the Line Interface Module, except the Analog Key, is done by the Installer when your phone is installed. For more information, refer to [Programming Features on Your Keys](#) and [Using the Line Interface Module](#).

## Tips for Your Comfort and Safety

### Don't cradle the handset!

Prolonged use of the handset can lead to neck, shoulder, or back discomfort, especially if you cradle the handset between your ear and shoulder. If you use your phone a lot, you may find it more comfortable to use a headset. See the section on headset usage elsewhere in this guide for more information.

### Protect your hearing

Your phone has a control for adjusting the volume of the handset receiver or headset. Because continuous exposure to loud sounds can contribute to hearing loss, keep the volume at a moderate level.

### Adjust the viewing angle

The stand built into your phone tilts to give you a better view of the keys.

To tilt your telephone for better viewing:

1. Turn the phone so that the front faces away from you.
2. Hold the base unit firmly and press the release tabs on the sides of the stand to detach the base unit.
3. Hinge the hooks of the base unit into the notches on the back of the phone and snap into place as follows:
  - a. For a high-angle mount, hinge the two lower hooks into the bottom set of notches and snap the two upper hooks into the middle set of notches.
  - b. For a low-angle mount, hinge the two lower hooks into the middle set of notches and snap the two upper hooks into the top set of notches.

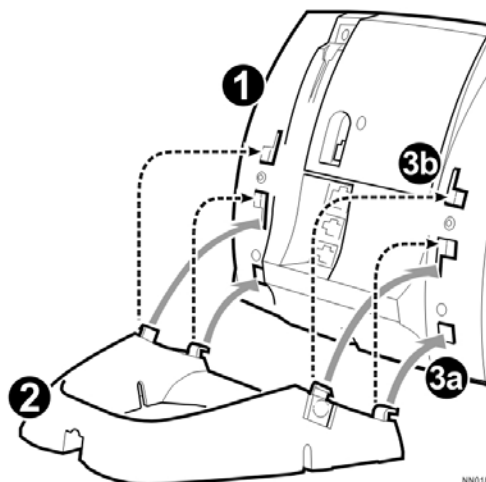

NN0183

## ACD Agent Features and Capabilities

### What are Agent Groups?

Traditional ACD agents or hot desk ACD agents may be grouped together to handle incoming telephone calls that are associated with particular functions or departments in an organization; for example, Sales or Engineering. Callers are then directed to the group that best serves their needs. The formation of ACD agent groups with two or more agents in each group allows calls to be handled on a group basis rather than on an individual basis. An agent can have multiple Agent IDs, but agents can login to only one Agent ID per telephone.

Traditional agent groups or hot desk agent groups are assigned a unique 3-digit reporting number as well as an Agent Group directory number. You will use both of these numbers as discussed throughout this guide.

Agent groups can be programmed to overflow between each other. This means that if activated, calls that are directed to one Agent Group can be programmed to overflow to other agent groups if the first group was unavailable due to being in an overload condition. This overflow capability allows ACD calls to be handled, even though an agent group has been set in a Do Not Disturb mode.

ACD Express Groups associate hot desk ACD agents into one group, but take advantage of ACD Path features, including limited support for RADs, embedded media for music on hold, overflow, and resilience.

You can have your set programmed to receive additional information concerning Group activity. This information is called Queue Threshold Alert and Queue Status.

### About ACD Agent Hot Desking

The ACD Agent Hot Desking feature allows you to log into any hot desk enabled set or ACD enabled set and the system automatically configures the set with your personal speed calls, features, and phone settings. If your user profile is configured as a hot desk ACD agent, when you log into a hot desk enabled set or ACD enabled set, the system associates your personal phone settings, such as directory number, system settings, language display, and button programming with the set.

For example, you could log into a hot desk enabled set or ACD enabled set, dial a number, and the system stores that number against the **Redial** key for your set profile. After logging out, if you log into another hot desk enabled set or ACD enabled set, you can press the **Redial** key to dial the last number that you had dialed previously while you were logged into the other set.

After logging in as a hot desk ACD agent, you can use the following personal phone features and change the following settings:

- Call forwarding (all types)
- Callback messages (message waiting indicator)

- Auto Answer
- Do Not Disturb (DND)
- Last Number Redial
- Timed Reminder
- Triple Ring Callbacks
- Advisory Status Message
- Group Presence

### **ACD Express Agents**

An ACD Express Agent is a hot desk ACD agent. A hot desk ACD agent becomes an ACD Express Agent on the system when the first group in which it is programmed is an ACD Express Group.

ACD Express Agents have the same behaviors as hot desk ACD agents, except that ACD Express Agents:

- never consume an ACD license. They consume a User license at provisioning time. Resilient ACD Express Agents consume the user license on the primary ICP.
- can be members of ACD Express Groups.
- can be members of up to eight different ACD Express Groups.
- cannot be members of ACD 2000 Agent Skill Groups.

## Logging In

Automatic Call Distribution (ACD) calls are directed to Logged In Agents only. ACD calls are not directed to a telephone where there is no Agent Logged In. You can log in by following the procedure described below.

An important concept in the ACD system for you to be aware of is agent mobility. As an Agent you are assigned a 1- to 7-digit Identification (I.D.) number to log in with. You can be called by this I.D. number, as well as by the telephone extension number where you are working. This means that you can be called by your I.D. number regardless of where you may be located. For this reason, it is also a good idea for your Agent I.D. number to be included in your company's telephone directory.

As an Agent, you can belong to multiple groups. When you log in using your Agent I.D., you are automatically logged in to all groups in which you are a member. Check with your manager if you do not know the ACD Log-In access code or do not have an I.D. number. The Agent I.D. number is unique to each Agent, and allows the system to distribute ACD calls to Logged In Agents. An Agent can stay logged in indefinitely on the same telephone. You can also log in by using an alternative Feature Access code not explained in this guide.



**Note:** A **Superkey** feature key must be programmed on your set to allow you to access ACD features. Contact your system administrator for assistance.



**Note:** If the I.D. is in use by another Agent, or the I.D. is invalid, the Log-In procedure is terminated. If an Agent Log-In code is dialed, but no I.D. is entered within 60 seconds, the Log-In procedure is not activated and your set is treated as a Logged Out set.

After you have logged in, you can display your Log-In information. See "Displaying Agent Log-In Information" for further details. If you are a traditional ACD agent, you require your Agent ID to log in; if you are an ACD hot desk agent, you require your Agent ID and your User Personal Identification Number (PIN).

### To log in as a traditional agent:

---



**Note:** You will need to program a **SuperKey** feature key on your set.

1. Press **SuperKey**. "Agent Login?" is displayed.
2. Press **Yes**.
3. Dial your Agent ID number and press **Enter**.

### To log in as a hot desk ACD agent or ACD Express agent:

1. Press **HotDesk**. "No User Logged In" appears in the display.
2. Press **Login**. "Enter your Ext#" is displayed.
3. Dial your Agent ID number and press **OK**. "Enter your PIN" appears.
4. Enter your PIN and press **OK**.

## Displaying Agent Log-In Information

It is possible to display and verify Log-In information when you are logged in to a set. The information displayed is the Agent I.D. number logged in at that set. To display Agent Log-In information

1. Press **SuperKey**.
2. Press **No** until PERSONAL KEYS appears on the display.
3. Press **Yes** and the Agent Identification (I.D.) number currently logged in will be displayed for 3 seconds.
4. The prompt SELECT A KEY appears. You may select another Line Select Key for similar information if the set has more than one line appearance.

If you press your Prime Line Key, your display shows your Agent I.D. number and your name (if programmed).

5. To exit, press **SuperKey**.

## Logging Out

Logging out returns the set to Make Busy and it no longer receives Automatic Call Distribution (ACD) calls, since ACD calls are directed to Logged-In telephones only. Your set operates normally for non-ACD use when logged out.

Logging Out can be activated during a call in progress, and takes effect only when you terminate (hang up) the call. This allows you to activate this feature before your set can ring again for another call.

### To log out:

1. Press **SuperKey**.
2. Press **No** until AGENT LOGOUT? appears in the display.
3. Press **Agent Logout**. You are now logged out. After a few seconds, LOGGED OUT appears on the display.



**Note:** If you log out of an agent session while a call is in progress, "LOGGED OUT" will not appear in the display until the call is ended.

## Answering Calls

Answering ACD calls is not unlike answering regular calls. When the telephone rings, the indicator beside your Line Select Key flashes.

To answer the call, pick up the handset and begin speaking.

A headset option can be programmed into your system, eliminating the need to pick up the handset. This is helpful in high call traffic situations normally encountered in an ACD environment. To use a headset, refer to "Using A Headset". You should also refer to "Using the Auto Answer Feature" for high telephone traffic situations.

## Using the Auto Answer Feature

You may prefer to answer your calls automatically using the Auto Answer feature, for either handset or headset operation. If Auto Answer is activated, when you receive a call you hear one short ring before being automatically connected to the caller.

Never leave your telephone unattended while the Auto Answer feature is turned on.

### Activating Auto Answer

**To activate the Auto Answer feature:**

1. Press **SuperKey**.
2. Press **No** to scroll until AUTO ANSWER? appears on the display.
3. Select **Turn On**. Auto Answer is now activated and AUTO ANSWER appears on the display.

### Deactivating Auto Answer

**To deactivate the Auto Answer feature:**

1. Press **SuperKey**.
2. Press **No** until AUTO ANSWER? appears on the display.
3. Select **Turn Off**. Auto Answer is deactivated and AUTO ANSWER disappears from the display.



## Using a Headset



**Note:** Your system administrator may have enabled full-time headset operation on your telephone. Telephones with full-time headset operation enabled must be operated only with headsets.

Telephones that are not programmed for full-time headset operation should be programmed with a Headset feature key to allow you to switch between handset and amplified headset (no feature control switch) operation.

Switching between handset and headset mode when using a Headset with Feature Control Switch can be accomplished by connecting or disconnecting the headset at the quick-disconnect plug on the headset cord, but you should also disable headset operation if the handset will be used for an extended period of time.

A headset can be used either in regular answer mode or with the Auto Answer feature programmed.

Most headsets are installed using the same jack that the handset plugs into. Mitel Networks Headsets with Feature Control Switch (PN 9132-800-500-NA/ 9132-800-501-NA) plugs into the dedicated headset jack (the jack nearest the front of the set).

### Installing a Headset (no Feature Control Switch)

#### To install the headset for your use

1. When the telephone is not in use, lift the handset from the cradle and carefully turn the set upside down.
2. Unplug the handset cord where it connects to the telephone.
3. Plug in the headset cord in the same place.
4. Set the telephone upright and press the **Headset** feature key.
5. Store your handset in a safe place.

#### To return to handset operation

1. When the telephone is not in use, lift the handset from the cradle and carefully turn the set upside down.
2. Unplug the headset cord where it connects to the telephone.
3. Plug in the handset cord in the same place.
4. Set the telephone upright and return the handset to the cradle.
5. Press the **Headset** feature key.
6. Store your headset in a safe place.

## Handling Calls with a Headset (no Feature Control Switch):

### To answer a call (when Auto Answer is disabled):

- Press the flashing Line Select key.

### To hang up:

- Press .

## Installing a Headset with Feature Control Switch

---



**IMPORTANT NOTE:** Mitel Networks Headsets with Feature Control must be installed in the dedicated headset jack (the jack nearest the front of the set). Installation will disable your headset microphone. Disconnecting the headset at the jack or at the quick-disconnect plug restores headset operation.

### To install the headset for your use

1. When the telephone is not in use, lift the handset from the cradle and carefully turn the set upside down.
2. Plug the headset cord into the headset jack (the jack nearest the front of the set).
3. Set the telephone upright and return the handset to the cradle.
4. Press the **Headset** feature key.

### To return to handset operation

1. When the telephone is not in use, lift the handset from the cradle and carefully turn the set upside down.
2. Unplug the headset cord where it connects to the telephone.
3. Set the telephone upright and return the handset to the cradle.
4. Press the **Headset** feature key.
5. Store your headset in a safe place.

## Handling Calls with a Headset (with Feature Control Switch):

### To answer a call (when Auto Answer is disabled):

- Press the flashing Line Select key  
-or-  
Quickly press and release the Feature Control Switch.

### To mute the headset microphone:

- Press and hold the Feature Control Switch.

### To hang up:

- Press   
-or-  
Quickly press and release the Feature Control Switch.

## Using and Canceling the Work Timer

The Work Timer provides a delay after each ACD call, before the next call is directed to you. This gives you a certain amount of time to complete any work generated by the previous call.

The Work Timer is automatic and you are not required to perform any procedures to activate it. The length of time provided by the timer varies from 0 to 600 seconds, and is programmed only by the System Administrator.

Work Timers apply to ACD Agents and ACD calls only. Other calls to and from your set do not activate a Work Timer. If the Make Busy or Do Not Disturb features are activated at your telephone, the Timer is cancelled for that call.

Once you terminate an ACD call, WORK TIMER appears on the display for the duration of the Work Timer period. When the Work Timer expires, WORK TIMER disappears from the display and you are ready to take another call.

You have the option of canceling the Work Timer and accepting another call before the Timer expires. Cancellation of the Timer affects only the next ACD call.

To cancel the Work Timer, press the  key. Your set displays the normal screen and is now available for the next ACD call.

## Taking a Break from Calls (Make Busy Feature)

Activate the Make Busy feature to stop receiving Automatic Call Distribution (ACD) calls at your set for relatively brief periods of time, thereby avoiding the need to log out and subsequently log in again. Make Busy ensures that your ACD set does not receive calls while you are unavailable to handle the calls.

Your Mitel IP Phone operates as a normal telephone except for ACD use during the Make Busy state. You can activate this feature between calls or during a call in progress. The Make Busy state commences upon completion of that call. This allows you to activate this feature before your set can ring again for another call.



### Notes:

- Your System Administrator can configure the system to automatically place your set in Make Busy when you log in. In this case, you must remove Make Busy before you can start taking ACD calls.
- A **Superkey** feature key must be programmed on your set to allow you to access ACD features. Contact your system administrator for assistance.

## Activating Make Busy

To activate the Make Busy feature:

1. Press **Superkey**.
2. Press **No** until MAKE BUSY? appears on the display.
3. Press **Make Busy**. Your set displays MAKE BUSY until you deactivate it.

## Removing Make Busy

To deactivate the Make Busy feature:

1. Press **Superkey**.
2. Press **No** until MAKE BUSY? appears on the display.
3. Press **Clear Busy**. Make Busy is removed from your set.

## Queue Threshold Alert

Thresholds are programmed into the ACD system to provide a basis for alerting Agents and Supervisors that calls have waited longer than acceptable limits (thresholds) to be answered.

If your set is programmed with a Generic Group **Queue Status** Feature Key, it can provide a visual indication of the current workload conditions of the Automatic Call Distribution (ACD) Group into which you are logged. Your set may also be programmed to provide an audible alert that Queue Status has changed.



**Note:** Agents in the Logged Out, Do Not Disturb, or Make Busy states are not considered active Agents for the purpose of Queue Threshold Alert.

## Group Presence

Group Presence allows members of an ACD Group to make themselves “absent” or “present” in a group. Only members who are present in a group are offered calls to that group.

Users belonging to multiple groups can control their presence in each group separately through the use of feature keys (one for each group), or by dialing a feature access code (FAC) followed by the group number.

Supervisors can also dial a FAC from their phone to change the presence status of an agent.

### **To join an ACD group:**

1. Lift the handset.
2. Do one of the following:
  - Press the Group Presence Feature key to join the group associated with the key.
  - Dial the Group Presence - Join Group feature access code followed by the group directory number.

The LED associated with the key is steady lit when the member is present and off when absent.

### **To leave an ACD group:**

1. Lift the handset.
2. Do one of the following:
  - Press the Group Presence Feature key to join the group associated with the key.
  - Dial the Group Presence - Leave Group feature access code followed by the group directory number.

The LED associated with the key is steady lit when the member is present and off when absent.

### **To join all ACD groups:**

1. Lift the handset (optional on devices that support on-hook dialing).
2. Dial the Group Presence - Join All ACD Groups feature access code.

### **To leave all ACD groups:**

1. Lift the handset (optional on devices that support on-hook dialing).
2. Dial the Group Presence - Join All ACD Groups feature access code.

**To change another group member's presence status:**

1. Lift the handset.
2. Dial the Group Presence - Join Group Third Party or Group Presence - Leave Group Third Party .
3. Dial the directory number of the group member.
4. Dial the group directory number.

## Visual Indications

If your set is programmed to provide a visual alert, the indicator beside the **Queue Status** Feature Key indicates the three levels of alert as follows:

- a solid indicator beside the Line Select Key on your set indicates that the workload is below the first threshold limit programmed
- a slowly flashing indicator indicates that the workload is above the first but below the second threshold limit programmed
- a quickly flashing indicator indicates that the workload is above the second threshold limit programmed.

## Audible Indications

For sets programmed for audible indications, the system provides the following different ringing patterns, depending on the threshold alert status:

- a single ring occurs when the longest waiting caller exceeds the programmed first threshold time interval
- a double ring occurs when the longest waiting caller exceeds the programmed second threshold time interval
- a single or double ring occurs when a previous threshold time interval is reverted to (i.e., when the longest waiting call is answered and the next longest waiting caller is in a different threshold level).

## Displaying Queue Status

Agents may access the following queue-status information about their Group:

- the number of active Agents in the Group
- the number of calls waiting for the Group (queue)
- the length of time that the longest call has been waiting for the Group.



**Note:** Agents in the Logged Out, Do Not Disturb, or Make Busy states are not considered active Agents for the purpose of Queue Status.

### When You Need To Know Your Group's Queue Status

- If your set is programmed with a Generic Group **Queue Status** Feature Key, press the key.

## Personal Directory

Your Extension Number: \_\_\_\_\_

Your Agent I.D. Number: \_\_\_\_\_

Your User PIN (ACD hot desk agents only): \_\_\_\_\_

Your Supervisor's Extension Number: \_\_\_\_\_

Your Group Name/Number: \_\_\_\_\_

Use this table to record your frequently used numbers.

**Name**

**Number**

Use this table to record the feature access codes you are most likely to need on your telephone.

**Feature**

**Access Code**

Auto Answer

Do Not Disturb

Headset Operation

Make Busy

Group Presence - Leave Group

Group Presence – Join Group

Group Presence - Leave All ACD Groups

Group Presence - Join All ACD Groups

Group Presence - Leave Group Third Party

Group Presence - Join Group Third Party







GLOBAL HEADQUARTERS	U.S.	EMEA	CALA	ASIA PACIFIC
Tel: +1(613) 592-2122	Tel: +1(480) 961-9000	Tel: +44(0)1291-430000	Tel: +1(613) 592-2122	Tel: +61(0) 2 9023 9500
Fax: +1(613) 592-4784	Fax: +1(480) 961-1370	Fax: +44(0)1291-430400	Fax: +1(613) 592-7825	Fax: +61(0) 2 9023 9501

FOR MORE INFORMATION ON OUR WORLDWIDE OFFICE LOCATIONS, VISIT OUR WEBSITE AT [MITEL.COM/OFFICES](http://MITEL.COM/OFFICES)

THIS DOCUMENT IS PROVIDED TO YOU FOR INFORMATIONAL PURPOSES ONLY. The information furnished in this document, believed by Mitel to be accurate as of the date of its publication, is subject to change without notice. Mitel assumes no responsibility for any errors or omissions in this document and shall have no obligation to you as a result of having made this document available to you or based upon the information it contains.

M MITEL (design) is a registered trademark of Mitel Networks Corporation. All other products and services are the registered trademarks of their respective holders.

© Copyright 2012, Mitel Networks Corporation. All Rights Reserved.

mitel.com

