

# SSW Series Spot Welders

Issued April 2009 • Index No. SW/3.1

**Water-Cooled Resistance Spot Welders** 

## Quick Specs

### Applications

Sheet Metal Work  
Light Fabrication  
Maintenance Work

### Process

Resistance Spot Welding

**Work Capacity** 20 kVA units weld total thicknesses up to 1/4 in (6.3 mm). Not recommended for aluminum or copper alloys.

**Rated Output** 20 kVA at 40% duty cycle depending on model, based on 10-second time period

**Weight** SSW 170–185 lb (77–84 kg) Depending on model

## The Power of Blue.®

**SSW models are designed for stationary use** and come with an all-steel pedestal which houses timers and controls.

SSW models come complete with:

- Stationary welding head
- Remote foot switch
- Pedestal inclusive of controls and timer
- Air filter/regulator assembly
- Order tongs/tips separately to match your applications



Air filter/regulator assembly included.

**Set-up/weld switch** permits checking of tong pressure and alignment without making a weld.

**Built-in squeeze/weld timer** makes it quick and easy to set or adjust squeeze and/or weld time in hundredths of a second.

**LED display** makes it easy to read and see timer settings.



**SSW foot switch** permits user to use both hands to position weldment between tongs. Can be held longer if longer hold time is desired.

All spot welders operate on **single-phase** input power, and require an air supply of **60 PSI** (414 kPa) **minimum**.

**Adjustable tong pressure nuts** to adjust tong pressure for different thicknesses and applications.

**Power switch/power “on” light/circuit breaker** protects control circuitry. Easy reset.

**Cam-operated locking device** simplifies installation and adjustment of bottom tong.

**Ten-step current control** adjusts output current with no change in duty cycle.



## Specifications (Subject to change without notice.)

**1**  
Phase

Model	Input 50/60 Hz	Work Capacity*	Rated Output**	Rated Output (Calibrated w/ standard-type tongs)			Max. Open- Circuit Voltage	Dimensions H x W x D	Net Weight
				6 in (152 mm)	12 in (305 mm)	18 in (457 mm)			
SSW-2020 ATT Stationary	230 VAC 90 Amps	1/4 in (6.3 mm)	20 kVA at 40% Duty Cycle	12,500 A	10,500 A	9000 A	3.55	49 x 11 x 21-3/4 in (1245 x 280 x 552 mm)	185 lb (84 kg)
SSW-2040 ATT Stationary	460 VAC 45 Amps								

\*Combined thickness uncoated mild steel using 6 in (152 mm) tongs.

\*\*Duty Cycle based on 10-second time period. (40% duty cycle means unit can weld for 4 second out of each 10-second time period.)



**Miller Electric Mfg. Co.**  
An Illinois Tool Works Company  
1635 West Spencer Street  
Appleton, WI 54914 USA

**Equipment Sales US and Canada**  
Phone: 866-931-9730  
FAX: 800-637-2315  
International Phone: 920-735-4554  
International FAX: 920-735-4125

**Web Site**  
www.MillerWelds.com



## Control Panel



1. Power "On" Light/Circuit Breaker/Switch
  2. Fuse to Protect Control Transformer
  3. Weld Amperage Control
  4. LED Display
  5. Set-Up/Weld Switch
- Place rocker switch in Set-Up position to check tong pressure and alignment without making weld.  
Place in Weld position when ready to activate actual squeeze and weld time.

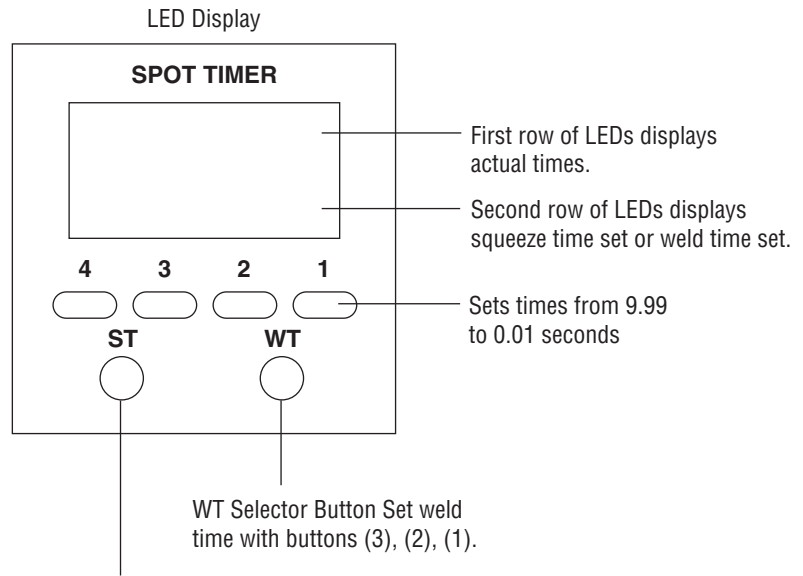

ST Selector Button  
Set squeeze time with buttons (3), (2), (1). Set enough time for tongs to close before weld amperage starts.

## Genuine Miller Accessories



**Tip Dresser #040 228**  
For use with pointed tips.



### Water Coolant Systems

For more information, see the Miller Coolant Systems literature sheet, Index No. AY/7.2.

#### Coolmate™ 3

#043 007 115 VAC

#043 008 230 VAC

For use with water-cooled torches rated up to 600 amps. Unique paddle-wheel indicator, external filter and easy-fill spout.

#### Coolmate™ V3 #043 009 115 VAC

For use with water-cooled torches rated up to 500 amps. Vertical design conveniently mounts to Miller cylinder rack in place of one cylinder.

#### Coolmate™ 4 #042 288

For use with water-cooled torches rated up to 600 amps. Tough molded polyethylene case with carrying handle.

#### Coolants

#043 810 Coolant, low-conductivity





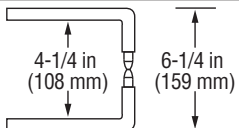
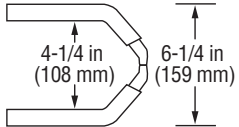
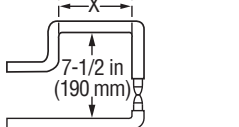
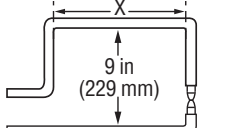



#043 809 Coolant, aluminum protecting  
Sold in cases of four 1-gallon recyclable plastic bottles. Miller coolants contain a base of ethylene glycol and deionized water to protect against freezing to -37°F (-38°C) or boiling to 227°F (108°C). Both also contain a compound that resists algae growth.

## Tongs and Tips (Must be ordered separately from spot welders. One pair of tips are supplied with each set of tongs.)

TONGS	TONG LENGTH			TIPS INCLUDED
	6 in (150 mm)	12 in (304 mm)	18 in (457 mm)	
 <p>STANDARD 90° No. 1 Morse Taper No. 2 Morse Taper</p>	#040 218 —	#040 219 —	#040 220 #041 001	#040 223 #040 308
 <p>STANDARD 45° No. 1 Morse Taper No. 2 Morse Taper</p>	— —	#041 004 —	#041 005 #040 296	#040 851 #040 225
 <p>TT-6W No. 2 Morse Taper</p>	—	—	#041 838	#040 308
 <p>TT-9W No. 2 Morse Taper</p>	—	—	#041 840	#040 308

### Notes for tongs and tips:

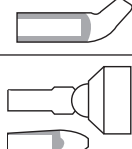
- Tongs and tips shown to the left can be used with all PSW and SSW model spot welders. Recommended max. tong length is 18 in (457 mm).
- Tong throat-height dimension for standard 90° and 45° tongs is 4-1/4 in (108 mm). Throat length is measured from the center of the spot tips to the front water hose connection. X = tong length.
- One set of tips is supplied with each set of tongs.
- Tips are made of RWMA Class 2 alloy.
- Maximum welding capabilities are obtained with minimum tong length.
- MT = Morse Taper.
- No. 1 Morse Taper has smaller diameter than No. 2 Morse Taper.

TIPS	QUANTITY	WHERE USED
 <p>No. 1 MT (Pointed) #040 223</p>	2 tips	Standard No. 1 Tongs, 90°
 <p>No. 1 MT (Offset) #040 224</p>	2 tips	Standard No. 1 Tongs, 90°
 <p>No. 2 MT (Pointed) #040 308</p>	2 tips	Standard No. 2 Tongs, 90° TT-6W Tongs TT-9W Tongs
 <p>No. 1 MT (Offset) #040 851</p>	2 tips	Standard No. 1 Tongs, 45°
 <p>No. 1 MT (Offset) #040 226</p>	2 tips	Standard No. 1 Tongs, 90°
 <p>No. 1 MT (Offset) #040 298</p>	2 tips	Standard No. 1 Tongs, 90°
 <p>No. 2 MT (Offset) #040 225</p>	2 tips	Standard No. 2 Tongs, 45°
 <p>No. 1 MT (Flat Swivel Tip) Matching Pointed Tip #040 216</p>	2 tips	Standard No. 1 Tongs, 90°
 <p>Adapter (adapts No. 1 Morse Taper Tip to No. 2 receptacle) #040 227</p>	2 adapters	Standard No. 2 Tongs, 90° TT-6W Tongs (top) TT-9W Tongs (top)

# Typical Installations

## Stationary Resistance Spot Welding Basic Equipment

Order tongs and tips separately.

### Also required:

- Input power cord of proper size per NEC and local codes.
- Coolant source and two coolant hoses (5/16 ID). Hoses must be compatible with coolant.  
**Note: Oxy-acetylene hoses are not compatible with ethylene glycol.**
- Air hoses.

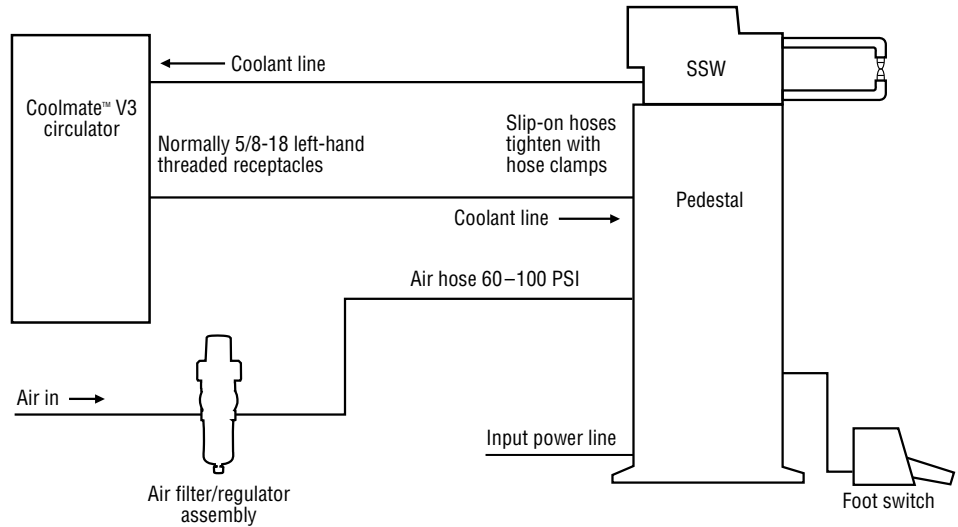

# Ordering Information

Equipment and Options	Stock No.	Description	Qty.	Price
<b>SSW-2020 ATT</b>	<b>#903 826</b>	Stationary, air-operated, 230 VAC, 50/60 Hz		
<b>SSW-2040 ATT</b>	<b>#903 827</b>	Stationary, air-operated, 460 VAC, 50/60 Hz		
<b>Tongs</b>				
Order separately		Ordered by the pair. One pair of tips included with each pair of tongs. See page 3 for tong/tip combinations		
<b>Tips</b>				
Order spares or additional types		One pair of tips included with each pair of tongs. See page 3 for tips that can be ordered in pairs or individually		
<b>Accessories</b>				
Tip Dresser	<b>#040 228</b>			
<b>Coolant Systems</b>				
Coolmate™ 3	<b>#043 007</b> <b>#043 008</b>	115 VAC 5/8-18 left-hand inlet/outlet receptacles 230 VAC 5/8-18 left-hand inlet/outlet receptacles		
Coolmate™ V3	<b>#043 009</b>	115 VAC 5/8-18 left-hand inlet/outlet receptacles		
Coolmate™ 4	<b>#042 288</b>	115 VAC 5/8-18 left-hand inlet/outlet receptacles		
<b>Coolant Solution</b>				
Low Conductivity	<b>#043 810</b>	1 gallon, must be ordered in multiples of 4		
Aluminum Protecting	<b>#043 809</b>	1 gallon, must be ordered in multiples of 4		
<b>Miscellaneous</b>				
Coolant Hoses		One coolant “out” and one coolant “in” hose required. One end 5/8-18 left-hand male fitting and the other end “slip-on” secured with hose clamp. 5/16 ID hoses must be compatible with coolant.		
Air Hoses		Air supply to air filter to back of controller. Air Filter has 1/4 in pipe thread female fittings. Controller has 5/8-18 left-hand thread female fittings.		
Input Power Cord		To be supplied by local source to meet local electrical codes and guidelines.		

Date: Total Quoted Price:

Distributed by:

