

mellerware®

TRENDS FOR LIFE



alexis
steam iron



complies with
INTERNATIONAL
IEC60335
SAFETY SPECIFICATIONS

m
1200W

CE
2 YEAR
GUARANTEE

Model:
23005G

PLEASE READ ALL INSTRUCTIONS BEFORE USE



KEY and CHARACTERISTICS

Description

1. Soleplate
2. Heat-insulated plate
3. Spray nozzle
4. Water tank
5. Spray button
6. Steam button
7. Pilot light
8. Temperature control knob
9. Handle
10. Front cover
11. Back cover
12. Power supply cord

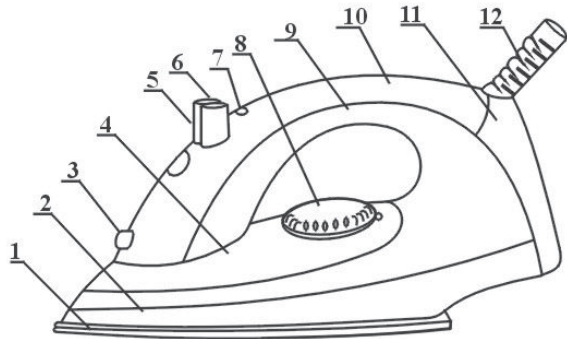

IMPORTANT SAFEGUARDS







1. This appliance is not intended for use by persons (including children) with reduced physical, sensory or mental capabilities, or lack of experience and knowledge, unless they have been given supervision or instruction concerning use of the appliance by a person responsible for their safety
2. Children should be supervised to ensure that they do not play with the appliance.
3. Do not operate the appliance with a damaged cord or plug or after the appliance malfunctions, or is dropped or damaged in any manner. Return the product to the nearest authorized service facility for examination, repair or electrical or mechanical adjustment. 1. Please read all instructions carefully before using the appliance for the first time.
4. Before connecting the appliance, check if the voltage indicated on the rating label corresponds with the mains voltage in your home.
5. Do not use appliance for anything other than its intended use.
6. The iron should always be switched off before connecting or disconnecting from the power supply. Do not pull on the cord to disconnect the plug from the wall socket.
7. Do not use the iron when it is damaged in any way. Do not operate the iron with a damaged cord or plug. Do not replace the power cord or any other parts by yourself. Bring the iron to the nearest authorized service facility or to the shop where you bought it, as special tools are required for repair.
8. When you have finished ironing or when you only leave it for a short while, stand the iron upright and then disconnect the iron from the wall outlet.
9. Do not allow children to touch the iron or the power cord when ironing.
10. Do not immerse the iron or the cord into water or any other liquid.
11. Do not touch hot metal parts, hot water or steam. These parts become hot and may cause burns.
12. The plug and cord should not be allowed to touch the hot soleplate. Let the iron cool down completely before taking it away.
13. Disconnect the iron from the wall outlet for pouring in

water or when you remove the water after use.

14. To avoid an overloaded circuit, do not operate another high voltage appliance in the same electric circuit.
15. Never use an extension power cord set that is not approved by a competent authority. The cord should be arranged in a way that it cannot be pulled or tripped over.
16. The iron is for household use only.

SAVE THE INSTRUCTION MANUAL FOR FUTURE REFERENCE

- Some parts of the iron have been slightly greased and as result the iron may smoke slightly when switched on for the first time. It will not happen again after a few uses.
- Before using for the first time, remove any protective films or stickers from the soleplate and the cabinet.
- Then clean the soleplate with the soft cloth. When using the iron for first time, test it on an old piece of fabric to ensure that the soleplate and water tank are completely clean.

NOTE:  On label means: THIS ARTICLE CANNOT BE IRONED! (eg: Chlorofibre, Elastodiene)		
LABEL	KIND OF TEXTILE	FIBRE MATERIAL
	Synthetic	Acrylic Modacryl Polypropylene Polyurethane
	Synthetic	Acetate Triacetate
	Synthetic	Metallized Cupro Polyamide (Nylon) Polyester Modal Viscose (Rayon)
	Silk	Silk
	Wool	Wool
	Cotton	Cotton
	Linen	Linen



IRONING INSTRUCTIONS

CHOICE OF WATER

- This iron can be used with normal tap water.
- If the water in your area is particularly hard, it is advisable to use distilled or de-mineralized water.
- Do not use chemically de-scaled water or any other liquids for refilling.

HOW TO FILL IN WATER

- Unplug the iron from the wall outlet.
- Press the steam control button (6) down, so that the steam won't come out.
- Fill in the water through the inlet.
- Do not fill the water past the maximum level "MAX" of the water tank. This may cause your iron to leak.

Important: Remove the water after use.

TEMPERATURE CONTROL SETTING

- Always check first to see whether a label with ironing instructions is attached to the article to be ironed.
- Follow these instructions in all cases.
- First you should sort the laundry: Wool with wool, Cotton with cotton etc. Start ironing the fabrics requiring the lowest temperature and progress to the higher ones because the iron heats up quicker than it cools down. If the fabric consists of various kinds of fibres (e.g. cotton with polyester) you must always select the lowest ironing temperature for the composition of those fibres.

SETTING THE TEMPERATURE

- Insert the plug into the wall socket and stand the iron upright.
- Turn the temperature control knob (8) to the correct temperature.
- The correct temperature will be reached when the pilot light has turned off. The pilot light will be on and off from time to time indicating that the selected temperature is being maintained.

SPRAYING

This function can be used any time and it does not affect the ironing temperature.

- Fill water into the iron as described above.
- Aim the nozzle to the garment.
- Press the spray button (5)

STEAM IRONING

This function can be used only at a higher ironing temperature.

- 2 dots for moderate steam
- 3 dots or MAX for maximum steam

- Fill water into the iron as described above.
- Stand the iron upright.
- Connect the iron to a suitable mains supply outlet.
- Turn the temperature control (8) to the "2 dots", "3 dots" or "MAX" setting.
- The pilot light turns off when the required temperature is reached. The iron is ready for use.
- Turn the steam button (6) to the required position, steam starts coming out from the holes in the soleplate.

Note: With conventional steam ironing, water may leak from the soleplate if a too low temperature has been selected. If this happens, turn the temperature control (8) to the advised position. Steam will recommence as soon as the appropriate temperature has been reached.

DRY IRONING

1. Connect the iron to a suitable mains supply outlet.
2. Ensure that the steam control knob (6) is in position "O".
3. Select the setting on the temperature control (8).
4. When the pilot light turns off, the required temperature is reached. The iron is ready for use.

CARE AND CLEANING

1. Disconnect the iron from the wall outlet and let it cool down completely.
2. Deposits and other residues on the soleplate can be removed with a rough cloth soaked in a vinegar/water solution.
3. The casting may be wiped with a damp cloth and then polished with a dry one.
4. Never use any abrasives to clean the soleplate.
5. Keep the soleplate smooth: avoid hard contact with metal objects.

STORAGE

- Turn the temperature control (8) to "MIN" and set the steam control knob to position "O" (=no steam)
- Disconnect the iron from the wall outlet.
- Pour any remaining water out of the water tank.
- Stand the iron upright and let it cool down completely.
- The power cord can be wound around the iron.
- Always store the iron in an upright position.

SAFETY PROTECTIVE CUT – OUT

In the unlikely event of the thermostat failing, the protection cut-out will operate to prevent the iron overheating. Then the iron should be taken to the nearest authorized service facility.



TROUBLE SHOOTING

Problem	Reason	Action	Pre-caution
Iron is leaking water.	Temperature is too low	Set the temperature to steam setting (cotton)	Check fabric type is suitable for high steam temperature
	Steam switch is on self clean function	Turn steam switch setting to steam or 0 position	Switch steam setting to 0 (off) after use or when filling tank.
	Tank is overfilled	Empty water tank	Fill to MAX mark only.
	Iron is in the horizontal position too long.	When adjusting item place iron down in the vertical position	If iron is left on the item in the horizontal position for too long it may burn the fabric.
Iron is not heating up	Temperature control dial is in the off position	Turn the temperature control dial to the desired temperature setting.	Check temperature setting is suitable for fabric type.
	Household socket is off.	Switch on household socket	Ensure iron is in the upright position.
	Household socket is not working	Check the socket with another appliance	Appliance must be of similar wattage to prevent overloading.
Iron is tripping mains	Overloaded circuit.	Unplug all appliances attached to the same circuit and check iron.	Note that there can be up to 5 household plug sockets on 1 circuit.
Iron sticking to clothing	Temperature is too hot	Turn down temperature on control dial. Clean and rinse item.	Check temperature setting is suitable for fabric type.
	Clothing is dirty or not rinsed thoroughly.	Use spray function to dampen item and check temperature is correct.	Use a old linen cloth to remove any trace of dirt on the soleplate. Use iron soleplate cleaner for bad marks.
Creases not coming out	Item is too dry or temperature too low.	Use steam function.	Check temperature setting is suitable for fabric type.
Not Enough Steam	The steam control is off or set too low.	Set the steam button/switch to on or full.	Ensure temperature control dial is set to the 3 dot position for steaming.
	The iron temperature is too low.	Set temperature control dial to MAX or 3 dot position for steaming.	Check temperature setting is suitable for fabric type.
	The steam valve is blocked due to water scale.	If your iron is fitted with a self clean function carry out cleaning as per instructions.	Use distilled or demineralised water in your iron to prevent blocking.

creative housewares

27 Nourse Avenue Epping 2 Cape Town
 PO. Box 975 Eppindust 7475 South Africa
 Tel: +27 21 534 8114 Fax: +27 21 534 8086
 Service Centre Share Call: 086 111 5006
 web: www.creativehousewares.co.za