

# Panasonic<sup>®</sup>

## Operating Instructions

---

Multi Purpose Camera

Model No. **AK-HC1800N**

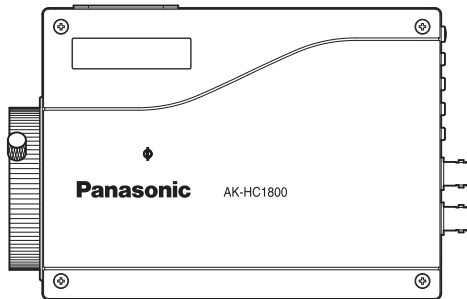

Before operating this product, please read the instructions carefully and save this manual for future use.



## CAUTION

**RISK OF ELECTRIC SHOCK  
DO NOT OPEN**



CAUTION: TO REDUCE THE RISK OF ELECTRIC SHOCK,  
DO NOT REMOVE COVER (OR BACK).  
NO USER SERVICEABLE PARTS INSIDE.  
REFER TO SERVICING TO QUALIFIED SERVICE PERSONNEL.



The lightning flash with arrowhead symbol, within an equilateral triangle, is intended to alert the user to the presence of uninsulated “dangerous voltage” within the product’s enclosure that may be of sufficient magnitude to constitute a risk of electric shock to persons.



The exclamation point within an equilateral triangle is intended to alert the user to the presence of important operating and maintenance (service) instructions in the literature accompanying the appliance.

For CANADA

**This class A digital apparatus complies with Canadian ICES-003.  
Cet appareil numérique de la classe A est conforme à la norme  
NMB-003 du Canada.**

### **FCC Note:**

This equipment has been tested and found to comply with the limits for a class A digital device, pursuant to Part 15 of the FCC Rules. These limits are designed to provide reasonable protection against harmful interference when the equipment is operated in a commercial environment. This equipment generates, uses, and can radiate radio frequency energy, and if not installed and used in accordance with the instruction manual, may cause harmful interference to radio communications. Operation of this equipment in a residential area is likely to cause harmful interference in which case the user will be required to correct the interference at his own expense.

### **Warning:**

To assure continued FCC emission limit compliance, the user must use only shielded interface cables when connecting to external units. Also, any unauthorized changes or modifications to this equipment could void the user’s authority to operate it.

 indicates safety information.

**WARNING:**

- TO REDUCE THE RISK OF FIRE OR ELECTRIC SHOCK, DO NOT EXPOSE THIS APPARATUS TO RAIN OR MOISTURE.
- THE APPARATUS SHALL NOT BE EXPOSED TO DRIPPING OR SPLASHING AND THAT NO OBJECTS FILLED WITH LIQUIDS, SUCH AS VASES, SHALL BE PLACED ON THE APPARATUS.

**CAUTION:**

TO REDUCE THE RISK OF FIRE OR SHOCK HAZARD AND ANNOYING INTERFERENCE, USE THE RECOMMENDED ACCESSORIES ONLY.

 indicates safety information.

# IMPORTANT SAFETY INSTRUCTIONS

Read these operating instructions carefully before using the unit. Follow the safety instructions on the unit and the applicable safety instructions listed below. Keep these operating instructions handy for future reference.

- 1) Read these instructions.
- 2) Keep these instructions.
- 3) Heed all warnings.
- 4) Follow all instructions.
- 5) Do not use this apparatus near water.
- 6) Clean only with dry cloth.
- 7) Do not block any ventilation openings. Install in accordance with the manufacturer's instructions.
- 8) Do not install near any heat sources such as radiators, heat registers, stoves, or other apparatus (including amplifiers) that produce heat.
- 9) Do not defeat the safety purpose of the polarized or grounding-type plug. A polarized plug has two blades with one wider than the other. A grounding-type plug has two blades and a third grounding prong. The wide blade or the third prong are provided for your safety. If the provided plug does not fit into your outlet, consult an electrician for replacement of the obsolete outlet.
- 10) Protect the power cord from being walked on or pinched particularly at plugs, convenience receptacles, and the point where they exit from the apparatus.
- 11) Only use attachments/accessories specified by the manufacturer.
- 12) Use only with the cart, stand, tripod, bracket, or table specified by the manufacturer, or sold with the apparatus. When a cart is used, use caution when moving the cart/apparatus combination to avoid injury from tip-over. 
- 13) Unplug this apparatus during lightning storms or when unused for long periods of time.
- 14) Refer all servicing to qualified service personnel. Servicing is required when the apparatus has been damaged in any way, such as power-supply cord or plug is damaged, liquid has been spilled or objects have fallen into the apparatus, the apparatus has been exposed to rain or moisture, does not operate normally, or has been dropped.

 indicates safety information.

# Contents

---

<b>Accessories</b> .....	5	<b>Operation procedure</b> .....	22
<b>Introduction</b> .....	6	<b>How to adjust</b> .....	23
<b>Characteristics</b> .....	6	■Flange back adjustment (for zoom lens) .....	23
<b>Precautions for use</b> .....	7	■Lens iris gain volume adjustment... ..	23
<b>Major operating controls and     their functions</b> .....	8	■White balance adjustment .....	24
<b>How to install</b> .....	13	■Color temperature and white balance adjustment (reference) .....	24
■How to set the lens .....	13	■Black balance adjustment .....	25
■How to install on the camera housing, pan/tilt head, tripod, etc. ....	13	■Gen-lock adjustment .....	25
<b>How to set up the system</b> .....	14	<b>Intelligent functions</b> .....	26
■Configuration example 1: Connection of camera controller ...	14	<b>Setting of menu items</b> .....	28
■Configuration example 2: High-speed P/T system (1) .....	15	■How to display the menus .....	28
■Configuration example 3: High-speed P/T system (2) .....	16	■TOP menu .....	28
■Configuration example 4: Controlling the camera from the AW-RP655 or AW-RP555 controller .....	17	① MAINTENANCE menu .....	29
■Control exercised from the AW-CB400 .....	18	② SETTING menu .....	44
■When the camera is to be controlled from the AW-RP655 controller ...	19	③ CAMERA ID menu .....	62
■When the camera is to be controlled from the AW-RP555 controller ...	20	④ FILE OPERATION menu .....	63
■Cable wiring specifications when connecting the camera directly to the AW-CB400, AW-RP655 or AW-RP555.....	21	■Menu list .....	64
		<b>Appearance</b> .....	68
		<b>Specifications</b> .....	69

# Accessories

---

<b>Operating instructions</b> .....	1
<b>Lens cap</b> .....	1
<b>Filter</b> .....	2

# Introduction

---

This camera employs new 2/3" 2.2 million-pixel IT CCD, realizing a compact light-weight system including the optical system.

The newly developed CCD image sensor, 14-bit A/D converter and brand-new DSP make for a wide dynamic range.

The camera supports the 1080/59.94i HD format.

Making the best use of the features of a small-sized self-contained camera, it is accommodated in the camera housing and able to provide high-quality HD pictures as a multi purpose digital camera.

## Note

- This product does not support the optional boards (AK-HHD1500G and AK-HDC1500G).

# Characteristics

---

**New 2/3" 2.2 million-pixel CCD is employed. [1920(H) × 1080(V)]**

- 2.2 million-pixel CCD is 2/3" in size, being compact and light-weight.

**14-bit A/D conversion and brand-new DSP featured**

- Wide dynamic range achieved
- Crystal-clear shooting even of images with different brightness levels
- Boosting of gain to a maximum 72 dB enabled
- Electronic extender function provided
- Cine gamma supported

**Multiple functions**

- Multi-function DTL such as high-luminance DTL and skin DTL.
- Right and left, top and bottom picture reversing function.

## Note

- In order to protect the environment when the multi purpose camera is to be discarded at the end of its service life, ask a specialized contractor to dispose of it properly.

# Precautions for use

---

## DON'TS

- Do not attempt to disassemble the camera or other units. In order to prevent electric shock, do not remove screws or covers. There are no user-serviceable parts inside.
- Do not abuse the camera. Avoid striking, shaking, etc. The camera contains sensitive components which could be damaged by improper handling or storage.
- Do not let the lens remain uncapped when the camera is not use. If the lens is not installed, do not leave the lens mount hole uncovered.
- Do not touch the surface of the lens or prism.
- Do not use strong of abrasive detergents when cleaning the camera body.
- Do not aim the camera toward the sun, no matter whether it is turned on or not.
- Do not expose the camera to rain or moisture, and do not try to operate the equipment in wet conditions. Do not operate the camera if it becomes wet.
- Do not operate the camera outdoors during a lightning storm.
- Do not use the camera in an extreme environment where high temperatures or high humidity exist.
- Do not leave the camera turned on when not in use. Do not unnecessarily turn the camera power on and off repeatedly.  
Do not block the ventilation slots.
- Do not cover the port otherwise block ventilation during operation. Internal heat buildup can cause a fire.

## DO'S

- Refer any servicing to qualified service personnel.
- Handle the camera with care.
- Protect the precision made lens by placing the lens cap over when the camera is not in use. If the lens is not installed, protect the surface of the prism by placing the body cap into the lens mount hole.
- Use a mild blower or lens cleaning tissue designed for coated lenses, to clean the surface of the lens or prism in the event that it should become dirty.
- Use a dry cloth to clean the camera if it is dirty. In case the dirt is hard to remove, use mild detergent and wipe gently.
- Use caution when operating the camera in the vicinity of spot lights or bright lights, as well as light reflecting objects and surfaces.
- Take immediate action if ever the camera should become wet. Turn the power off and have the unit checked by an authorized service facility.
- Follow normal safety precaution to avoid personal injury.
- Use the camera in an environment where the temperature is within 32 °F – +104 °F (0 °C – +40 °C), and the relative humidity is within 30 % – 90 % (no condensation).
- Always turn the power off when the camera is not going to be used. Operate the camera only when there is adequate ventilation.
- Cooling fan  
There is internally provided a cooling fan.  
Since the cooling fan is a consumable part, replace it after about 30,000 hours of operation.  
(Be sure to ask the dealer for the replacement.)

# Major operating controls and their functions

## ■ Front view

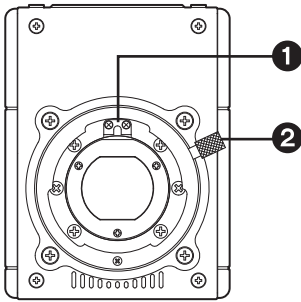

## ■ Top view

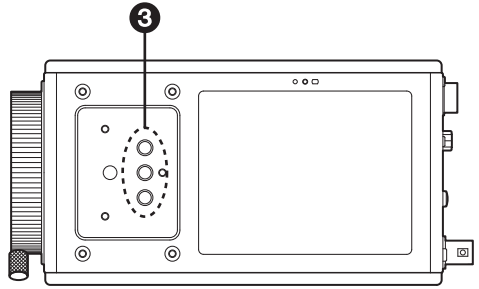

## ■ Bottom view

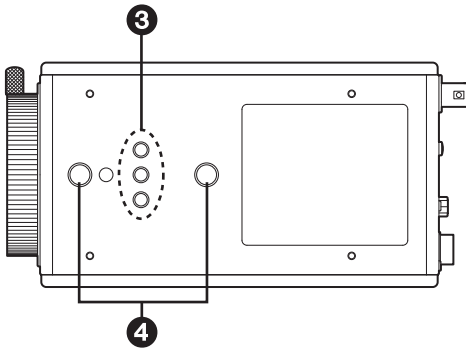

## ■ Rear view

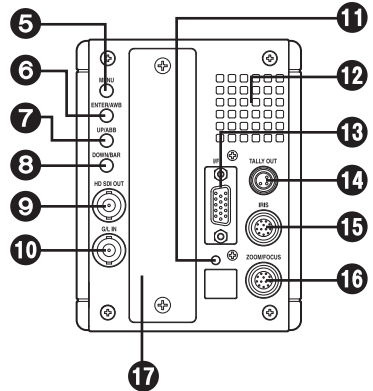



# **Major operating controls and their functions**

## **① Lens mount**

2/3" standard bayonet type (B4 mount) lens is installed.

## **② Lens fixing ring knob**

Lens is fixed by turning the knob clockwise.

## **③ Camera mounting hole (1/4-20UNC)**

## **④ Camera mounting hole (3/8-16UNC)**

The screw holes can be used to secure the camera for installing it on camera housing, and when using a pan/tilt head or a tripod. The screw holes are 10 mm deep. Use screws which are less than 10 mm long.

## **⑤ MENU switch [MENU]**

A menu will appear on the monitor screen when MENU switch is pressed for at least 3 seconds. The menu screen is cleared when the switch is pressed for at least 3 seconds while the menu is displayed.

## **⑥ ENTER/AWB switch [ENTER/AWB]**

The item just below can be selected by pressing this switch while the menu is on the screen.

When the menu is not displayed or the camera is in shooting mode, the automatic white balance control (AWB) can be set with this switch.

## **⑦ UP/ABB switch [UP/ABB]**

The item just above can be selected by pressing this switch while the main menu is displayed.

While the Sub menu is displayed, any setting can be brought up to a higher value with this switch.

When the menu is not displayed or the camera is in shooting mode, the automatic black balance control (ABB) can be set with this switch.

## **⑧ DOWN/BAR switch [DOWN/BAR]**

The item just below can be selected by pressing this switch while the Sub menu is on the screen.

While the Sub menu is displayed, any setting can be brought down to a lower value with this switch.

When the menu is not displayed, the color bar and the shooting conditions are alternately indicated by pressing the switch for about 5 seconds.

# Major operating controls and their functions

## 9 HD SDI output connector [HD SDI OUT]

HD SDI signal output is given by this line.

## 10 G/L input connector [G/L IN]

For gen-lock with the camera, the external sync signal (black burst) or tri-level sync signal is supplied to this input connector.

## 11 Operate indicator

Green LED lamp lights to indicate that the specified DC 12 V power is supplied to the interface connector 13.

## 12 Cooling fan

- Do not block or obstruct the ventilation during operation. It may otherwise cause internal heating or fire.
- The life of this fan is approximately 30,000 hours (at room temp. 77 °F (25 °C)). Replace the fan as needed.  
(When the room temperature is higher than 95 °F (35 °C), replace the fan 30 % earlier.)  
Be sure to ask the dealer for the replacement.

## 13 Interface connector [I/F]

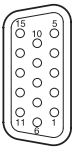

Pin No.	Signal
1	Gen-lock signal GND
2	Not used
3	Not used
4	TX_N (EIA422)/TXD (EIA232) output
5	RX_N (EIA422)/RXD (EIA232) input
6	DC power supply input (+12 V)
7	Gen-lock signal input
8	DC GND
9	TX_P (EIA422) output
10	RX_P (EIA422) input
11	GND
12	Not used
13	GND
14	GND
15	GND

When supplying DC power, supply the DC +12 V voltage to pin 6 and connect GND to pin 8.

# Major operating controls and their functions

- Use the multi-cable provided with the AK-HRP150G when supplying power from the AK-HRP150G.
- Use the cable provided with the AW-PH650 when supplying power from the AW-PH650.
- When supplying power from the AW-PH400, use the AW-CA15H29G or the AW-CAK4H1G cable kit depending on the configuration of the control system.
- Use the AW-CA15H29G when supplying power from the AW-PH405.
- When supplying power separately, ensure that the specifications of the interface cable given below are satisfied.

## Interface cable specifications

Use a cable with a performance equivalent or superior to the specifications given below.

### AK-HC1800N (High-density D-sub 15-pin connector)

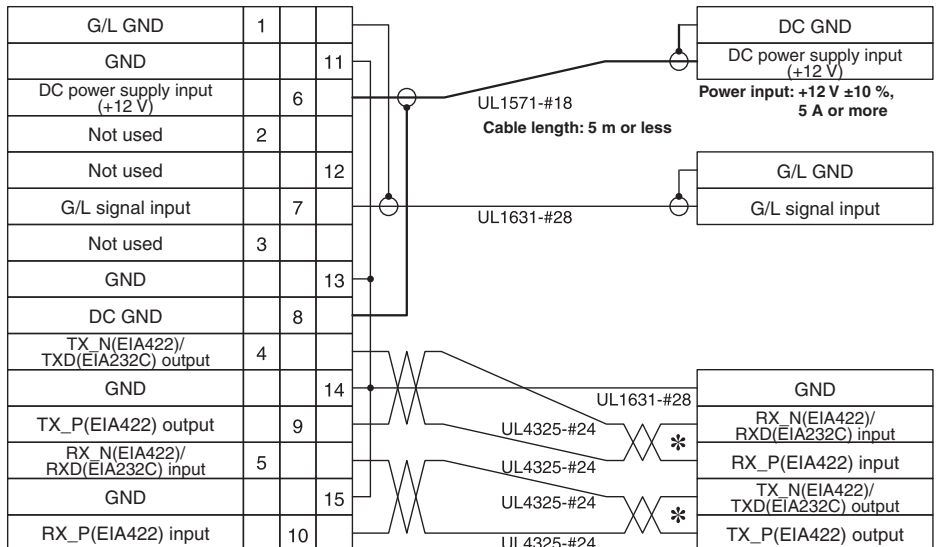

Connector: DHW10-153F200  
made by Advanced Connectek Inc.

Cover: DE-C8-J9-F5-1R  
made by Japan Aviation Electronics Industry, Ltd.

\* Use a twisted-pair cable.

# Major operating controls and their functions

## 14 Tally output connector [TALLY OUT]

The R tally and G tally signals are output from this connector.

Pin No.	Signal
1	GND
2	R_TALLY_OUT
3	G_TALLY_OUT
4	+12 V (500 mA Max)

## 15 IRIS connector [IRIS]

Used to connect the IRIS control cables of the lens.

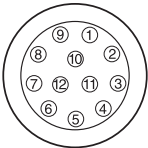

Pin No.	Signal	Pin No.	Signal
1	Return control	7	Iris follow
2	VTR-S/S	8	Iris auto selection
3	UNREG GND	9	—
4	Iris manual selection	10	Zoom position information
5	Iris control	11	Focus position information
6	UNREG 12 V	12	NC

## 16 Zoom/Focus connector [ZOOM/FOCUS]

Used to connect the zoom/focus control cables of lens.

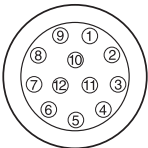

Pin No.	Signal	Pin No.	Signal
1	Focus control selection	7	COM
2	Zoom control selection	8	Focus control
3	GND	9	Zoom control
4	Forcible iris closing	10	Iris control selection
5	Iris control	11	COM +Voltage
6	+Voltage	12	COM -Voltage

## 17 Optional card slot

Slot for inserting an optional card.

### Note

- This product does not support the optional boards (AK-HHD1500G and AK-HDC1500G).

# How to install

Be sure to ask the dealer for the installation, adjustment and connection of this equipment.

## ■ How to set the lens

### ● Standard 2/3" bayonet type (B4 mount) lens of any makers can be used\*.

- ① Turn the lens fixing ring knob counterclockwise to remove the lens mount cap.
- ② Set the lens in place, and turn the lens fixing ring knob clockwise to precisely fix the lens.
- ③ Connect the iris control cable to the IRIS connector.
- ④ Connect the zoom/focus control cable to the ZOOM/FOCUS connector.

\* Note that there are some lenses uncontrollable with respect to zoom, focus function.

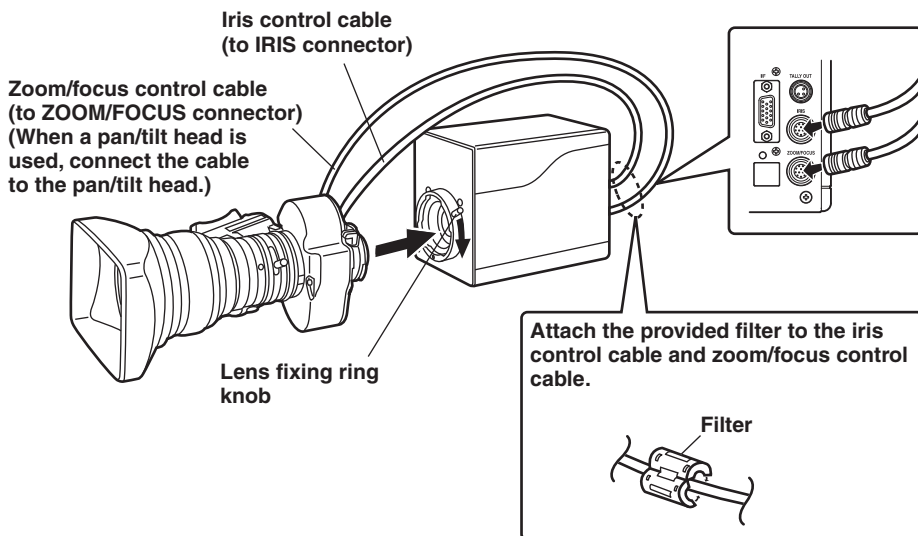

## ■ How to install on the camera housing, pan/tilt head, tripod, etc.

- ① Precisely set the camera on the camera housing, pan/tilt head, tripod, etc. by using the camera set-screw hole (1/4-20UNC, 3/8-16UNC).
- ② When mounting the camera on a pan/tilt head, be sure to use proper tools and make sure that there is no fear of falling off.

# How to set up the system

## ■ Configuration example 1: Connection of camera controller

- Use multi cable supplied with AK-HRP150G for the connection of camera controller AK-HRP150G and this unit.

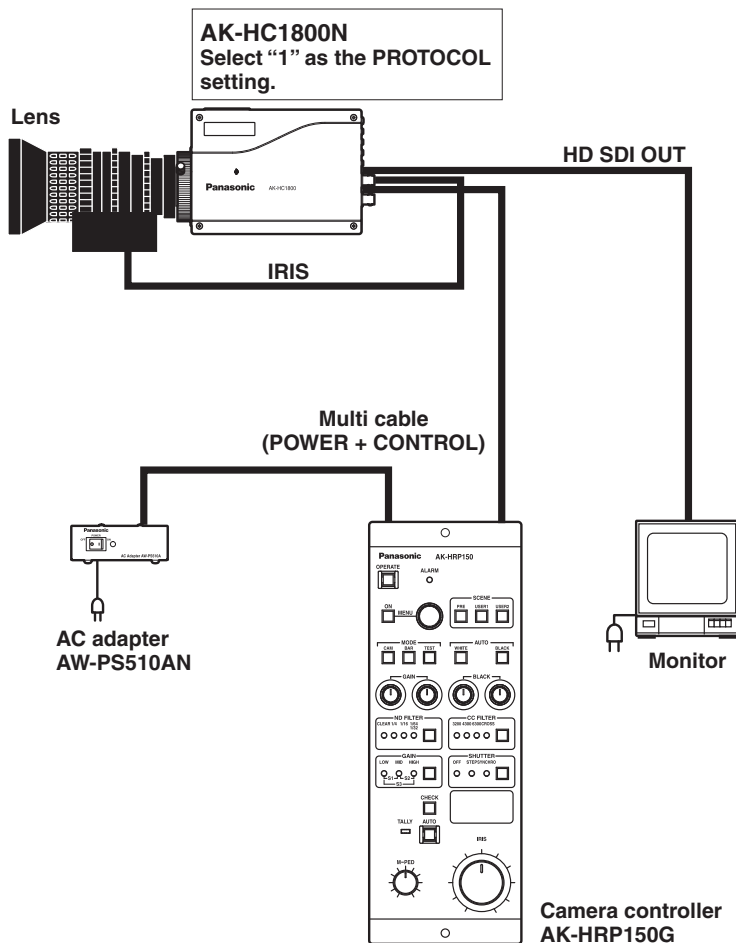

- ① Before connecting the cables, be sure to set the power switch of AC adapter to OFF.
- ② Connect the multi cable to the interface connector of the camera, and the opposite side to camera controller.
- ③ Set the AC adapter power switch to ON, then the camera can be controlled.
- ④ After shooting, set the AC adapter power switch to OFF.

# How to set up the system

## ■ Configuration example 2: High-speed P/T system (1)

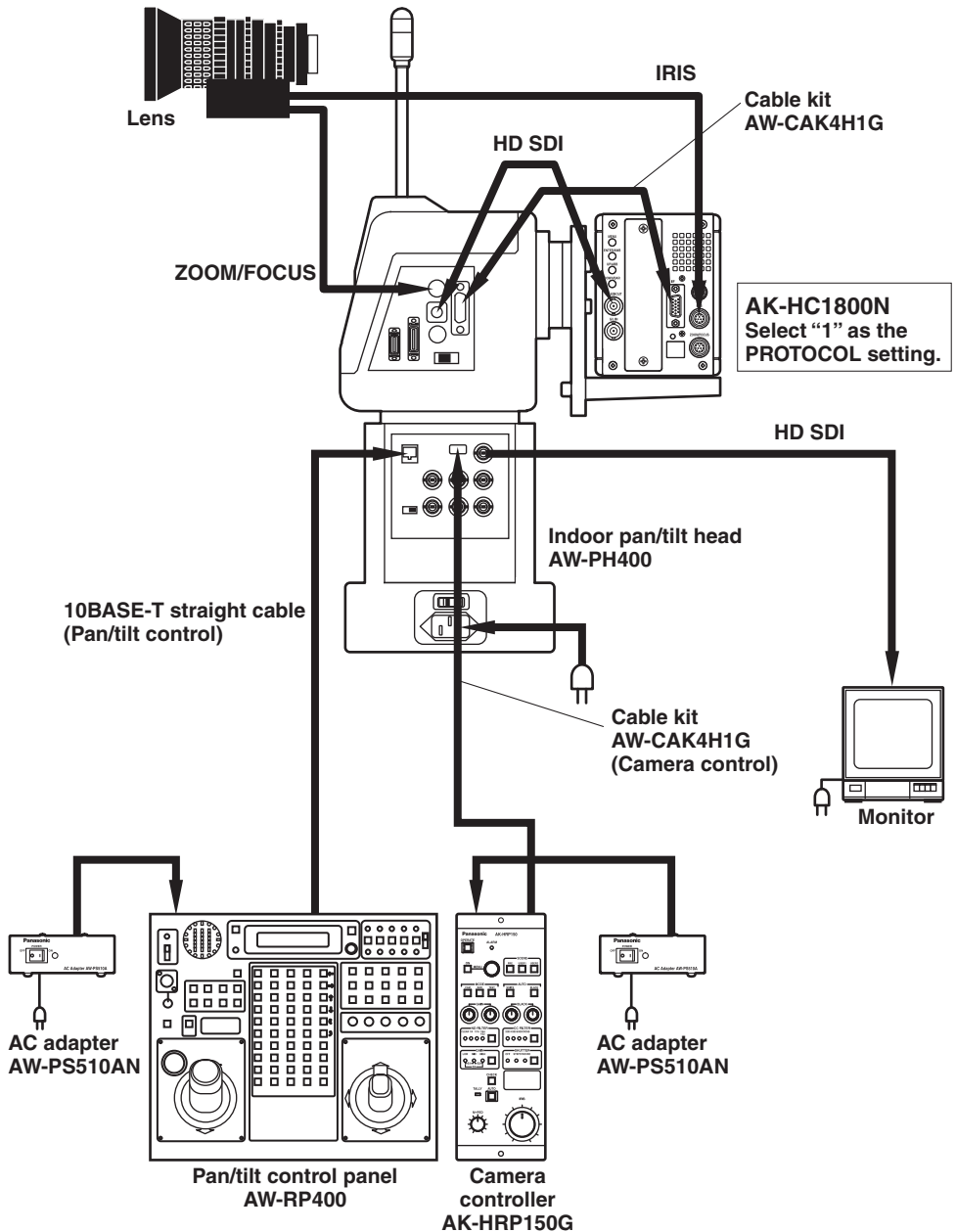

# How to set up the system

## ■ Configuration example 3: High-speed P/T system (2)

Set and check the communication protocol and video format prior to installation.

When mounting the camera on the AW-PH400 pan/tilt head and controlling it from the AW-CB400 remote operation panel, select "4" as the PROTOCOL setting of the AK-HC1800N.

When connecting it directly to and controlling it from the AW-CB400, select "3" as the PROTOCOL setting.

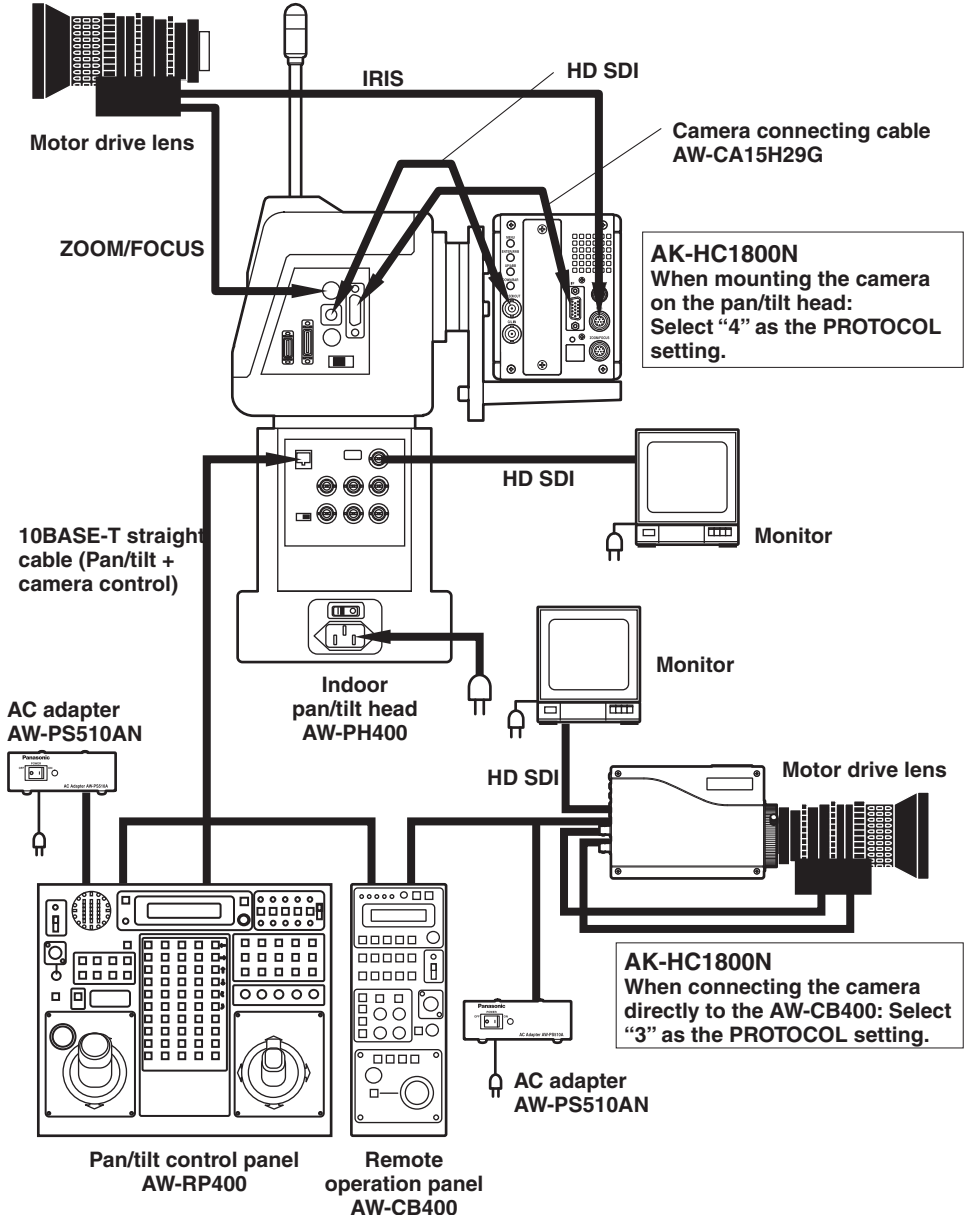



# How to set up the system

## ■ Configuration example 4: Controlling the camera from the AW-RP655 or AW-RP555 controller

When installing the camera on the AW-PH650 outdoor pan/tilt head, refer to the operating instructions of the AW-PH650.

When placing the camera on the AW-PH650 and controlling it from the AW-RP655 or AW-RP555 controller, select "4" as the PROTOCOL setting of the AK-HC1800N, and set the camera control selector switch inside the housing of the AW-PH650 to "CB400."

When using G/L signals, select "DSUB" as the GEN-LOCK INPUT setting of the AK-HC1800N.

Be absolutely sure to perform and check these settings prior to installation.

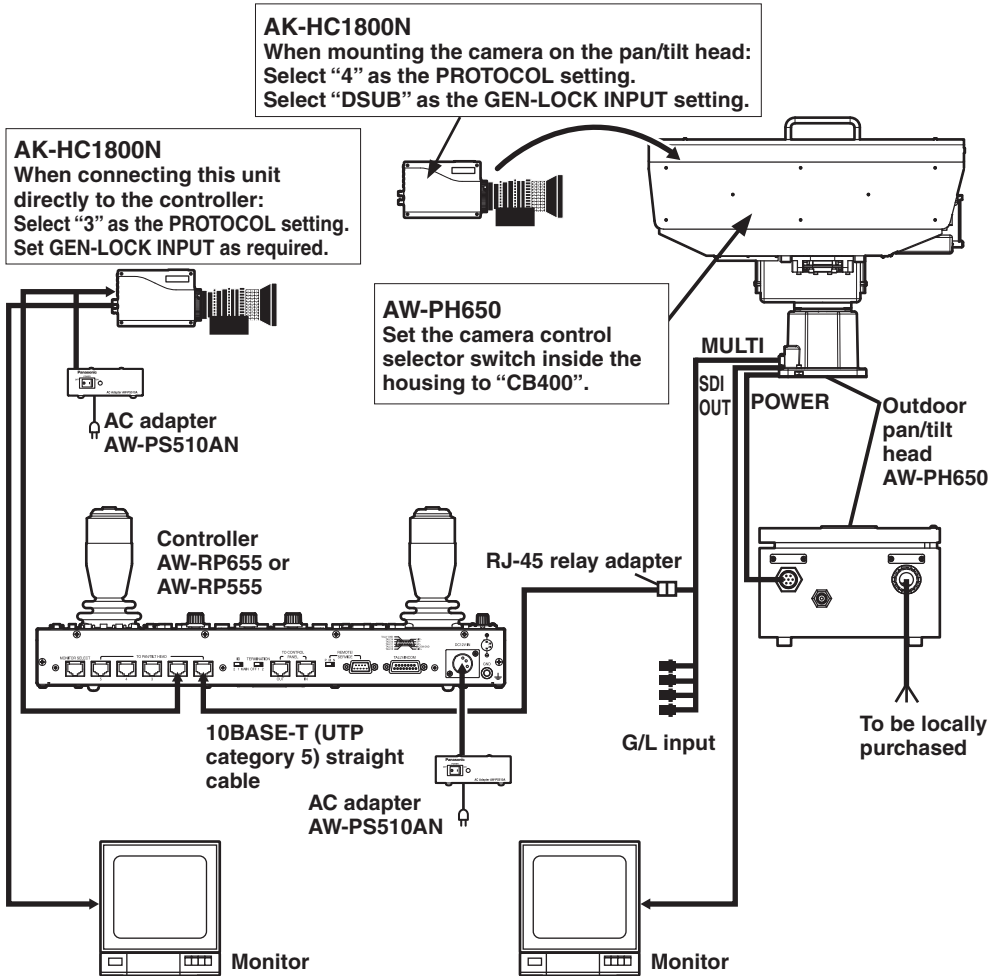

When the AK-HC1800N, to which the motor drive lens is connected, has been directly connected to the AW-RP655 or AW-RP555 controller, zooming and focusing can be controlled using the controller's joystick.

# How to set up the system

## ■Control exercised from the AW-CB400

When using the AW-CB400 for the AK-HC1800N, its switches and dials function as shown in the figure below.

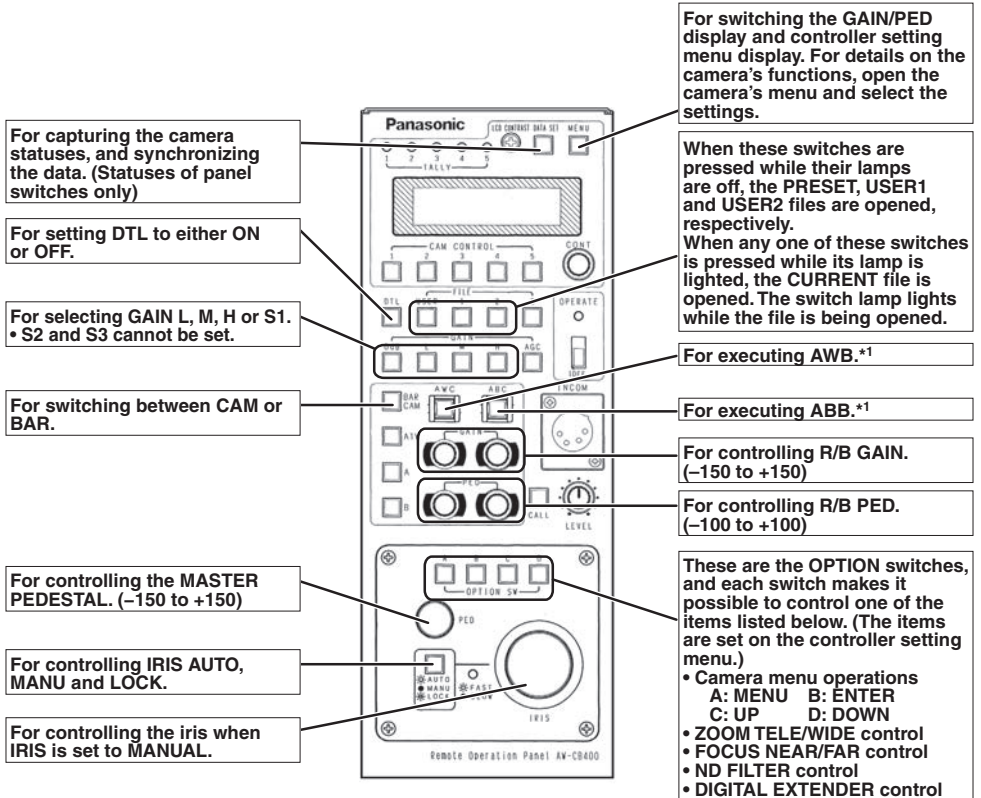

\*1: The lamp of the ABB or AWB switch flashes while automatic white balance or automatic black balance is being executed, respectively. When ABB or AWB is completed successfully, the corresponding lamp goes off; when it is not completed successfully, it lights up.

- When changing the panel display for use with the AK-HC1800N, please use panel sheet VGKB0008 (sold separately as a replacement part).

Ver.2.00 or a subsequent version of the AW-CB400 software must be installed in order for the AK-HC1800N to be controlled using the AW-CB400.

To check the software version of your AW-CB400, contact your dealer.

# How to set up the system

## ■When the camera is to be controlled from the AW-RP655 controller

Each time the MODE button is pressed, the setting is switched between CAM and BAR. The MODE button lights up at the BAR setting.

For executing AWB.\*1

When the LCD is in the gain adjustment mode  
Select the desired gain setting from GAIN SELECT LOW to S.GAIN3.  
When the LCD is in the pedestal adjustment mode  
Adjust the M PEDESTAL setting (-150 to +150).  
When the camera menu mode is established  
Perform the camera menu operations.

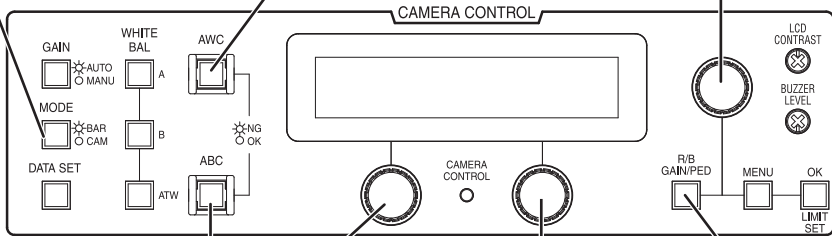

For executing ABB.\*1

Switch between gain adjustment mode and pedestal adjustment mode.

When the LCD panel is in the gain adjustment mode  
Adjust the R GAIN setting (-150 to +150).  
When the LCD panel is in the pedestal adjustment mode  
Adjust the R PEDESTAL setting (-100 to +100).

When the LCD panel is in the gain adjustment mode  
Adjust the B GAIN setting (-150 to +150).  
When the LCD panel is in the pedestal adjustment mode  
Adjust the B PEDESTAL setting (-100 to +100).

\*1: The lamp of the ABB or AWB switch flashes while automatic white balance or automatic black balance is being executed, respectively. When ABB or AWB is completed successfully, the corresponding lamp goes off; when it is not completed successfully, it lights up.

In the case of the AK-HC1800N camera, the following buttons on the AW-RP655 will not work.

- WHITE BAL A/B/ATW
- GAIN AUTO/MANU
- DATA SET

When the AK-HC1800N, to which the motor drive lens is connected, has been directly connected to the AW-RP655 controller, zooming and focusing can be controlled using the controller's joystick.

- When changing the panel display for use with the AK-HC1800N, please use panel sheet VGKB0007 (sold separately as a replacement part).

### Procedure for camera menu operation (AW-RP655)

- ① Press the MENU button to set the LCD panel display to the menu mode.
  - ② Turn the jog dial (main) to select CAMERA SETTING.
  - ③ Press the OK button.
  - ④ The right display appears on the LCD panel:  
When the OK button is pressed again, the menu of the AK-HC1800N appears on the monitor.
- HC CAMERA MENU  
OPEN? → OK Key
- ⑤ Turn the jog dial (main) to modify menu items of the AK-HC1800N and change the data. When changing the data, the data settings are decremented by turning the dial clockwise and incremented by turning it counterclockwise. Push the jog dial (main) down to enter the settings.
  - ⑥ To exit the camera menu, press the MENU button or R/B GAIN/PED button.

Ver.0010 or a subsequent version of the AW-RP655 software must be installed in order for the AK-HC1800N to be controlled using the AW-RP655.  
To check the software version of your AW-RP655, contact your dealer.

# How to set up the system

## ■When the camera is to be controlled from the AW-RP555 controller

Each time the GAIN button is pressed, the setting is switched in the sequence of LOW → MID → HIGH → S.GAIN1, and the mode is displayed by the LEDs as shown below.

	GAIN button	MANU L LED	MANU H LED
LOW	OFF	OFF	OFF
MID	OFF	ON	OFF
HIGH	OFF	OFF	ON
S.GAIN1	ON	OFF	OFF

When these buttons are pressed while their LEDs are off, the PRESET, USER1 and USER2 files are opened respectively. When a button is pressed while its LED is lit, the CURRENT file is opened. The LED of a button blinks while its file is being opened.

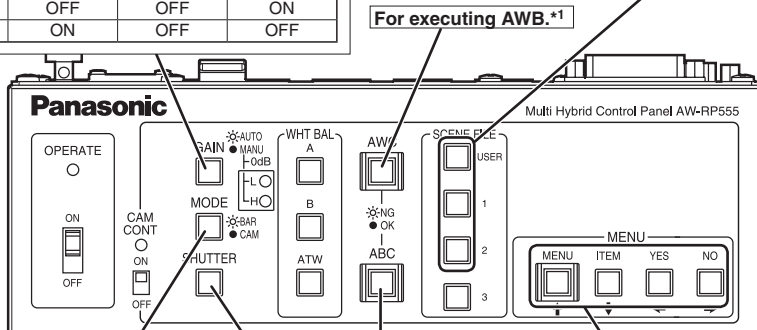

Each time the MODE button is pressed, the setting is switched between CAM and BAR. The MODE button lights up at the BAR setting.

### Shutter mode selection

Each time this button is pressed, one of the shutter modes set by the controller or "shutter OFF" is selected. The SHUTTER button lights up in all modes except shutter OFF. The shutter mode settings established by the PRESET buttons are as follows.

MODE	PRESET No.	MODE	PRESET No.
1/100	PRESET1	1/2000	PRESET6
1/120	PRESET2	---	PRESET7
1/250	PRESET3	SYNCHRO	PRESET8
1/500	PRESET4	---	PRESET9
1/1000	PRESET5	OFF	PRESET10

Use these buttons to perform the camera menu operations.

- MENU: This operates in the same way as MENU on the camera.
- ITEM: This operates in the same way as ENTER on the camera.
- YES: This operates in the same way as UP on the camera.
- NO: This operates in the same way as DOWN on the camera.

In the case of the AK-HC1800N camera, the following buttons on the AW-RP555 will not work.

- WHITE BAL A/B/ATW
- SCENE FILE 3

\*1: The lamp of the ABB or AWB switch flashes while automatic white balance or automatic black balance is being executed, respectively. When ABB or AWB is completed successfully, the corresponding lamp goes off; when it is not completed successfully, it lights up.

When the AK-HC1800N, to which the motor drive lens is connected, has been directly connected to the AW-RP555 controller, zooming and focusing can be controlled using the controller's joystick.

- When changing the panel display for use with the AK-HC1800N, please use panel sheet VGKB0006 (sold separately as a replacement part).

Ver.041 or a subsequent version of the AW-RP555 software must be installed in order for the AK-HC1800N to be controlled using the AW-RP555.

To check the software version of your AW-RP555, contact your dealer.

# How to set up the system

## ■ Cable wiring specifications when connecting the camera directly to the AW-CB400, AW-RP655 or AW-RP555

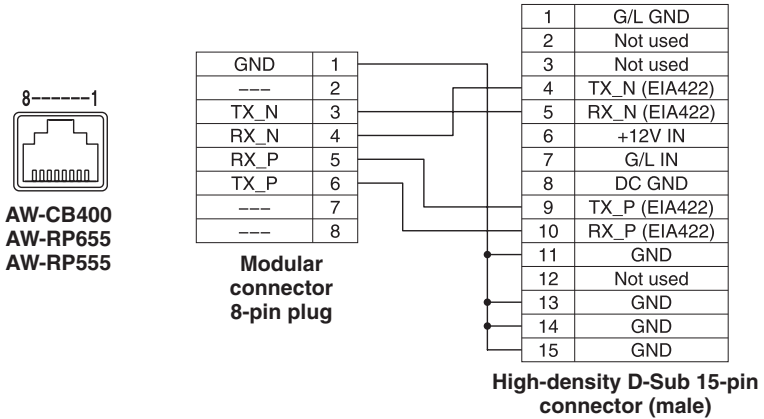

# ***Operation procedure***

---

**1 Turn on the power of each equipment.**

**2 Properly adjust the light for the object.**

**3 Adjust the flange back of the lens, the iris and the focus.**

- Flange back must be adjusted when the camera is used for the first time or after replacement of the lens.

**4 Adjust the white balance.**

- This adjustment is needed when the camera is used for the first time or after leaving unused for a long time.
- The adjustment is necessary when the lighting condition or brightness is changed.
- After adjusting the white balance once, re-adjustment is not needed under the same condition.

**5 Adjust the black balance.**

- This adjustment is needed when the camera is used for the first time or after leaving unused for a long time.
- The adjustment is necessary when the ambient temperature is greatly changed or at the change of season.
- After adjusting the black balance once, re-adjustment is not needed under the same condition.

**6 Start shooting.**

(After shooting, be sure to turn off the power of each equipment connected.)

# How to adjust

## ■ Flange back adjustment (for zoom lens)

The adjustment is to adjust the focus in all the range from the maximum zoom to the widest angle of the zoom lens.

- ① Shoot a dark object to open the iris.
- ② Adjust the distance from the object to 6.6 ft. (2 m) at least, then loosen the flange back fixing knob of the lens.
- ③ Set the lens to the maximum zoom and adjust the focus by turning the focus ring.
- ④ Set the lens to the widest angle and adjust the focus by turning the flange back adjust ring.
- ⑤ Repeat adjusting the focus ring and flange back adjust ring until the focus is adjusted within the zooming range.
- ⑥ After finishing the adjustment, tighten the flange back fixing knob.

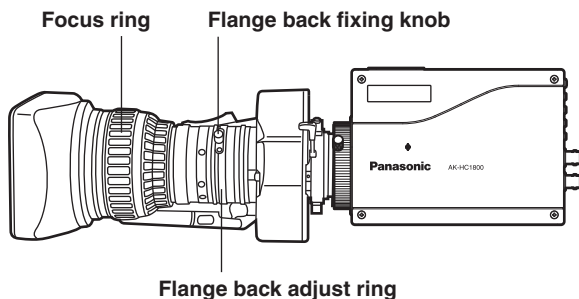

## ■ Lens iris gain volume adjustment

Iris gain adjust hole (G or S) is provided at front of the lens housing. Adjust the iris according to the following procedure by using a screwdriver.

- ① Set the iris select switch of the lens to A "AUTO" side.
- ② Turn the iris gain adjust volume to maximize the gain in such extent that no hunting takes place.

\* When CAM is selected as the IRIS MODE setting on the camera menu, IRIS gain on the menu can be used to make adjustments.

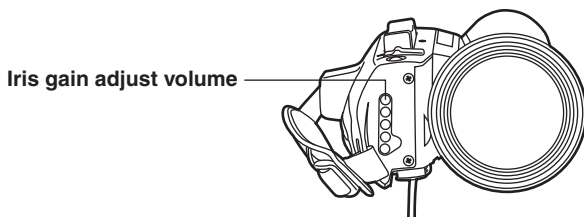

Auto iris power zoom lens

# How to adjust

## ■ White balance adjustment

Adjust the white balance after shooting a white object by at least 50 % of the screen.

**Note:** If the white signal level is over 100 % or less than 50 %, the white balance may not be normally adjusted.

## ■ Color temperature and white balance adjustment (reference)

When carbon is burnt, it develops various colors of light depending on the temperature. Natural light can be specified by color temperature reflecting to the color developed when carbon is burnt.

The light of 3,200K (K=Kelvin,  $-273\text{ }^{\circ}\text{C}$  equals to absolute zero temperature 0K) represents the same value (color) as what develops when carbon is burnt at 3,200K (2,927  $^{\circ}\text{C}$ ).

The relationship between the color temperature of the light source and weather condition is indicated in the right figure. Let's study the difference of shooting an indoor object from shooting one outdoors. Studios are usually lighted with incandescent lamps and the color temperature of a white object in a studio is around 3,000K. The color temperature of a white object outdoors is around 6,500K. The former may look a little yellowish while the latter appears somewhat bluish when they are shot by a camera.

However, the human eye does not recognize color differences among these objects even under different ambient lighting conditions, because of their adaptability to light.

The video camera reproduces color differences with high fidelity and the color of an object somewhat different from what appears to the human eye.

Therefore, there is a need to adjust the white balance in order to correct differences between color temperatures.

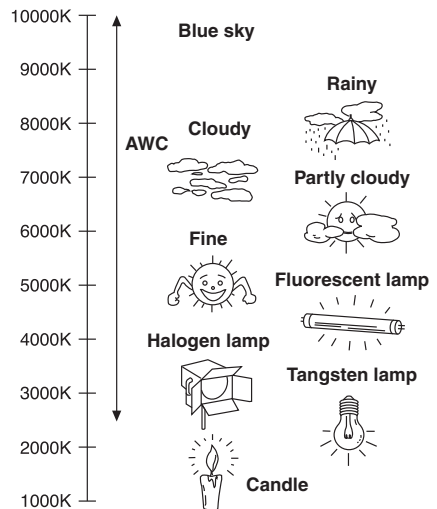

### Note

- Color temperature outdoors may vary depending on weather conditions.



# How to adjust

---

## ■ Black balance adjustment

- **Adjust it with the lens closed.**

When the motor drive lens is controlled from the camera, adjusting the black balance causes the lens to be automatically closed.

## ■ Gen-lock adjustment

When multiple cameras are used or the camera is combined with other equipment, it is necessary to adjust the phase for phase matching by external synchronization.

- **Horizontal phase adjustment**

Observe the waveforms of externally synchronizing signal input (black burst signal) and video signal output by a two-phenomenon oscilloscope, and make the horizontal phase according to the camera menu.

### Adjustment with GEN-LOCK of SETTING menu

**When HD synchronizing signals are input:**

- ① Roughly adjust the synchronizing signal input and video signal output phases by H PHASE-COARSE.
- ② Finely adjust the synchronizing signal input and video signal output phases by H PHASE-FINE.

```
--** GEN-LOCK **  
  
GEN-LOCK INPUT      :BNC  
H PHASE-COARSE      :+00  
H PHASE-FINE        :+000
```

**When SD synchronizing signals are input:**

- ① Roughly adjust the synchronizing signal input and video signal output phases by SD-HD PHASE CRS.
- ② Finely adjust the synchronizing signal input and video signal output phases by SD-HD PHASE FINE. If the adjustment performed using SD-HD PHASE is not satisfactory, use H PHASE-COARSE/FINE.

```
--** GEN-LOCK **  
  
GEN-LOCK INPUT      :BNC  
H PHASE-COARSE      :+000  
H PHASE FINE        :+000  
SD-HD PHASE CRS     :+0  
SD-HD PHASE FINE    :+00
```

# Intelligent functions

When using the camera in outdoor environments, the brightness and color temperature will differ significantly as the day progresses from the morning to the afternoon, to the evening to night. The camera's intelligent functions serve to automatically correct the video level and color temperature to compensate for the changes taking place outdoors.

In outdoor environments, the brightness changes significantly, by a factor of 10 to the power of 6, from 0.01 lux under a crescent moon to 10,000 lux under a clear sky. Similarly, there is a considerable change of 5000K in the color temperature from 3000K after sunrise to 8000K under a clear, bright sky.

In the past, the gain, lens iris, ND filter, and minus gain were supported as video levels adjustments, whereas manual gain adjustments and manual CC filter settings were supported as color temperature adjustments.

However, the problem with the user having to make these adjustments manually each time was that there was not enough time to select the optimum adjustments when a sudden emergency situation such as an earthquake arose, with the result that shooting opportunities were lost.

Now, using the intelligent functions, this kind of problem has been solved.

**Automatic video level adjustment method**

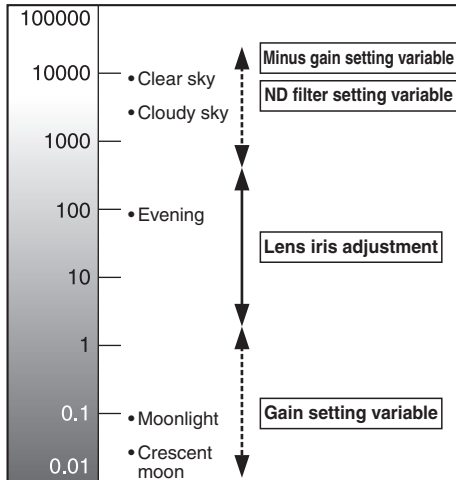

**Brightness (lux)**      **Type of light condition**

**Automatic color temperature adjustment method**

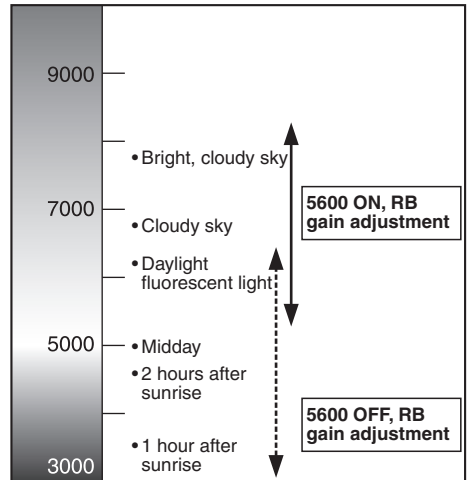

**Color temperature (K) of light**      **Type of light condition**

# ***Intelligent functions***

---

## **Automatic video level adjustment method:**

The video level is automatically adjusted by controlling the lens iris, gain (including pixel addition and frame addition), ND filter setting, and minus gain.

## **Automatic color temperature adjustment method:**

The color temperature is automatically adjusted by controlling the R and B gain levels from the D5600K OFF or ON setting.

The intelligent functions are set using the INTELLIGENT1, INTELLIGENT2, and INTELLIGENT SET menus accessed from the SETTING menu.

### **Notes**

- The intelligent functions are valid with the VIDEO MENU only; MANUAL (functions OFF) is the fixed setting with the FILM MENU. The INTELLIGENT menus are not displayed, either.
- The conditions established by the intelligent functions may differ depending on the camera settings, and optimal settings may not be selected even when filming under the same brightness and color temperature conditions.
- When V MIX or FRAME MIX is switched to ON or OFF during an AGC operation, shock noise accompanying the switching will be heard.
- When ON or SYNCHRO has been selected as the shutter setting, hunting may occur when FRAME MIX switches to ON or OFF.
- The color temperature may not be tracked properly under special shooting conditions such as backlight, reflected light, or sunset.

# Setting of menu items

---

## ■ How to display the menus

Two methods are used to display the menus.

- **Using AK-HC1800N multi purpose camera to display the menus:**

- ① Hold down the MENU switch on the rear panel of the main unit for at least 3 seconds to display the TOP menu.
- ② Use the UP/DOWN switch to move the cursor to the target item, and press the ENTER switch to move to a menu at a lower hierarchical level.

- **Using AK-HRP150G camera controller**

- ① Press the MENU ON/OFF switch on the AK-HRP150G so that its lamp lights. The TOP menu now appears.
- ② Move the cursor to the target item, and press the MENU switch to move to a menu at a lower hierarchical level.

## ■ TOP menu

When the VIDEO MENU is selected:

```
-USER MENU
1.MAINTENANCE
2.SETTING
3.CAMERA ID
4.FILE OPERATION
```

When the FILM MENU is selected:

```
-USER MENU (FILM MENU)
1.MAINTENANCE
2.SETTING
3.CAMERA ID
4.FILE OPERATION
```

# Setting of menu items

---

## ① MAINTENANCE menu

```
--* MAINTENANCE *  
1.BLACK SHADING  
2.PEDESTAL,GAMMA  
3.FLARE  
4.KNEE,WHITE CLIP  
5.R/B GAIN  
6.DETAIL  
7.SKIN TONE DETAIL  
8.GAIN,AUTO IRIS  
9.SUPER GAIN  
10.FRAME MODE  
11.MATRIX  
12.COLOR CORRECTION
```

### [1] BLACK SHADING

```
--* BLACK SHADING **  
  
DETECTION  
CORRECT(DIG) :OFF
```

#### **DETECTION**

For automatically correcting the black shading.

#### **CORRECT(DIG) [OFF, ON]**

For ON/OFF control of the detection correction.

# Setting of menu items

---

## ① MAINTENANCE menu

### [2] PEDESTAL, GAMMA

-** PEDESTAL, GAMMA (1/2) **	
M PEDESTAL	:+000
R PEDESTAL	:+000
B PEDESTAL	:+000
M GAMMA	:0.45
R GAMMA	:+00
B GAMMA	:+00
M BLACK GAMMA	:+00
R BLACK GAMMA	:+00
B BLACK GAMMA	:+00
GAMMA	:ON
BLACK GAMMA	:ON

#### **M PEDESTAL [-200 to +200]**

For adjusting the black level.

#### **R PEDESTAL [-100 to +100]**

For correcting the red in relation to the master pedestal.

#### **B PEDESTAL [-100 to +100]**

For correcting the blue in relation to the master pedestal.

When the AK-HRP150G has been connected, M PEDESTAL, R PEDESTAL and B PEDESTAL operations cannot be performed using the menu.

#### **M GAMMA**

**[0.30 to 0.75 (DRS OFF), -10 to +10 (DRS ON)]**

For adjusting the gamma characteristics.

#### **R GAMMA**

**[-15 to +15 (DRS OFF), -10 to +10 (DRS ON)]**

For adjusting the gamma characteristics of the red in relation to the master gamma characteristics.

#### **B GAMMA**

**[-15 to +15 (DRS OFF), -10 to +10 (DRS ON)]**

For adjusting the gamma characteristics of the blue in relation to the master gamma characteristics.

#### **M BLACK GAMMA [-32 to +32]**

For adjusting the gamma characteristics in the vicinity of the black.

#### **R BLACK GAMMA [-15 to +15]**

For adjusting the gamma characteristics of the red in the vicinity of the black in relation to the master gamma characteristics.

# Setting of menu items

---

## ① MAINTENANCE menu

### [2] PEDESTAL, GAMMA

```
---** PEDESTAL, GAMMA (1/2) **  
  
M PEDESTAL      :+000  
R PEDESTAL      :+000  
B PEDESTAL      :+000  
M GAMMA         :0.45  
R GAMMA         :+00  
B GAMMA         :+00  
M BLACK GAMMA   :+00  
R BLACK GAMMA   :+00  
B BLACK GAMMA   :+00  
GAMMA           :ON  
BLACK GAMMA     :ON
```

#### **B BLACK GAMMA [-15 to +15]**

For adjusting the gamma characteristics of the blue in the vicinity of the black in relation to the master gamma characteristics.

#### **GAMMA [OFF, ON]**

For turning the gamma correction ON or OFF.

#### **BLACK GAMMA [OFF, ON]**

For turning the black gamma correction ON or OFF.

When ON has been selected as the DRS setting, the BLACK GAMMA setting does not take effect.

### When the VIDEO MENU is selected:

```
---** PEDESTAL, GAMMA (2/2) **  
  
EFFECT DEPTH    :1  
DRS             :OFF
```

#### **EFFECT DEPTH [1 to 5]**

For selecting the effects of the contrast adjustment when ON has been set for DRS.

#### **DRS [OFF, ON]**

For adjusting the contrast automatically when this is set to ON.

### When the FILM MENU is selected:

```
---** PEDESTAL, GAMMA (2/2) **  
  
CINE GAMMA SELECT:FILM REC  
BLACK STR. LEVEL :00%  
DYNAMIC LEVEL    :500%
```

#### **CINE GAMMA SELECT [VIDEO REC, FILM REC]**

For selecting either the film-use or video-use cine gamma characteristics.

#### **BLACK STR. LEVEL [00% to 30%]**

For setting the BLACK STRETCH position.

#### **DYNAMIC LEVEL [200% to 500%]**

For setting the dynamic range.

# Setting of menu items

---

## ① MAINTENANCE menu

### [3] FLARE

```
--** FLARE **
```

```
R FLARE      :000  
G FLARE      :000  
B FLARE      :000  
FLARE        :ON
```

**R FLARE [000 to 100]**

**G FLARE [000 to 100]**

**B FLARE [000 to 100]**

For adjusting the flare correction.

**FLARE [OFF, ON]**

For turning the flare correction ON or OFF.



# Setting of menu items

---

## ① MAINTENANCE menu

### [4] KNEE, WHITE CLIP (When the KNEE is set to MANUAL)

```
---** KNEE, WHITE CLIP (1/2) **  
  
M KNEE POINT      :095.00%  
R KNEE POINT      :+00.00%  
B KNEE POINT      :+00.00%  
M KNEE SLOPE      :50  
R KNEE SLOPE      :+00  
B KNEE SLOPE      :+00  
A. KNEE POINT     :---  
A. KNEE LEVEL     :---  
M WHITE CLIP LVL  :109%  
R WHITE CLIP LVL  :+00%  
B WHITE CLIP LVL  :+00%
```

#### M KNEE POINT

[080.00% to 107.00% (VIDEO MENU)]

[30% to 90% (FILM MENU/VIDEO REC)]

For adjusting the knee point.

#### R KNEE POINT [-25.00% to +25.00%]

For correcting the knee point of the red in relation to the master knee point.

#### B KNEE POINT [-25.00% to +25.00%]

For correcting the knee point of the blue in relation to the master knee point.

#### M KNEE SLOPE

[00 to 99 (VIDEO MENU)]

[150% to 600% (FILM MENU)]

For adjusting the knee slope.

#### R KNEE SLOPE [-99 to +99]

For adjusting the knee slope of the red in relation to the master knee slope.

#### B KNEE SLOPE [-99 to +99]

For adjusting the knee slope of the blue in relation to the master knee slope.

The M KNEE POINT and M KNEE SLOPE settings do not take effect when a setting other than MANUAL is selected for KNEE or ON is selected as the DRS setting when the VIDEO MENU has been selected or when FILM REC is selected as the CINE GAMMA SEL setting when the FILM MENU has been selected.

Similarly, the R/B KNEE POINT and R/B KNEE SLOPE settings do not take effect when a setting other than MANUAL is selected for KNEE or ON is selected as the DRS setting when the VIDEO MENU has been selected or when the FILM MENU has been selected.

# Setting of menu items

---

## ① MAINTENANCE menu

### [4] KNEE, WHITE CLIP (When the KNEE is set to AUTO)

```
---** KNEE,WHITE CLIP (1/2) **---  
M KNEE POINT      :---  
R KNEE POINT      :---  
B KNEE POINT      :---  
M KNEE SLOPE      :---  
R KNEE SLOPE      :---  
B KNEE SLOPE      :---  
A. KNEE POINT     :095.00%  
A. KNEE LEVEL     :108%  
M WHITE CLIP LVL  :109%  
R WHITE CLIP LVL  :+00%  
B WHITE CLIP LVL  :+00%
```

**A. KNEE POINT [080.00% to 107.00%]**  
For setting the auto knee break point position. This setting does not take effect when a setting other than AUTO is selected for KNEE or ON is selected as the DRS setting when the VIDEO MENU has been selected or when the FILM MENU has been selected.

**A. KNEE LEVEL [100% to 109%]**  
For setting the maximum level of auto knee. This setting does not take effect when a setting other than AUTO is selected for KNEE or ON is selected as the DRS setting when the VIDEO MENU has been selected or when the FILM MENU has been selected.

**M WHITE CLIP LVL [090% to 109%]**  
For setting the white clip level.

**R WHITE CLIP LVL [-15% to +15%]**  
For correcting the amount of red for the M WHITE CLIP LVL.

**B WHITE CLIP LVL [-15% to +15%]**  
For correcting the amount of blue for the M WHITE CLIP LVL.

# Setting of menu items

---

## ① MAINTENANCE menu

### [4] KNEE, WHITE CLIP

```
---** KNEE,WHITE CLIP(2/2) **  
  
KNEE           :MANUAL  
WHITE CLIP     :ON  
HIGH COLOR     :OFF
```

#### **KNEE [OFF, MANUAL, AUTO]**

For selecting the knee operation mode.  
This setting does not take effect when FILM REC is selected or DRS is ON.

#### **WHITE CLIP [OFF, ON]**

For tuning white clip ON or OFF.

#### **HIGH COLOR [OFF, ON]**

For improving the color reproducibility of the high-brightness areas when it is set to ON.  
This setting does not take effect when a setting other than MANUAL is selected for KNEE or ON is selected as the DRS setting when the VIDEO MENU has been selected or when the FILM MENU has been selected.

### [5] R/B GAIN

```
---** R/B GAIN **  
  
R GAIN         :+000  
B GAIN         :+000  
ND FILTER      :CLEAR
```

#### **R GAIN [-200 to +200]**

For adjusting the gain of the red.

#### **B GAIN [-200 to +200]**

For adjusting the gain of the blue.

#### **ND FILTER [CLEAR, 1/4, 1/16, 1/64]**

For selecting the ND filter setting.

When the AK-HRP150G has been connected, the items on this page cannot be operated using the menu.

# Setting of menu items

---

## ① MAINTENANCE menu

### [6] DETAIL

```
*** DETAIL (1/2) ***  
  
DETAIL : ON  
TOTAL DTL LEVEL : +00  
H DTL LEVEL : 15  
CRISP : 06  
LEVEL DEPENDENT : 02  
PEAK FREQUENCY : 18  
KNEE APERTURE : ON  
KNEE APE LEVEL : 3
```

#### **DETAIL [OFF, ON]**

For turning all the detail functions ON or OFF.

#### **TOTAL DTL LEVEL [-31 to +31]**

For setting the H DTL and V DTL levels.

#### **H DTL LEVEL [00 to 63]**

For setting the H DTL level.

#### **CRISP [00 to 31]**

For setting the noise elimination level of the detail signals.

#### **LEVEL DEPENDENT [00 to 15]**

For removing the detail in the dark areas.

#### **PEAK FREQUENCY [00 to 31]**

For setting the H DTL peak frequency.

#### **KNEE APERTURE [OFF, ON]**

For turning the emphasizing of the outlines for the high-brightness areas ON or OFF.

#### **KNEE APE LEVEL [0 to 5]**

For adjusting the knee aperture level.

# Setting of menu items

---

## ① MAINTENANCE menu

### [6] DETAIL

```
*** DETAIL (2/2) ***  
  
SLIM DETAIL      : OFF  
DETAIL (+)      : +00  
DETAIL (-)      : +00  
DETAIL CLIP     : 00  
DETAIL SOURCE   : (G+R)/2
```

#### **SLIM DETAIL [OFF, ON]**

For setting the detail more finely at ON.

#### **DETAIL(+)[-31 to +31]**

For adjusting the detail gain in the + direction.

#### **DETAIL(-)[-31 to +31]**

For adjusting the detail gain in the – direction.

#### **DETAIL CLIP [00 to +63]**

For minimizing the glare caused by adding too much detail as a result of a detail clip adjustment.

#### **DETAIL SOURCE**

**[(G+R)/2, (G+B)/2, (2G+B+R)/4, (3G+B)/4, R, G]**

For setting the ratio of the RGB signal components which create the detail.

# Setting of menu items

---

## ① MAINTENANCE menu

### [7] SKIN TONE DETAIL

```
---** SKIN TONE DETAIL **  
  
SKIN TONE DTL      :OFF  
SKIN GET           :OFF  
SKIN DTL CORING   :5  
Y MAX              :190  
Y MIN              :010  
I CENTER           :014  
I WIDTH            :090  
Q WIDTH            :010  
Q PHASE            :+082
```

#### **SKIN TONE DTL [OFF, ON]**

For turning the SKIN TONE DTL ON or OFF.

#### **SKIN GET [OFF, ON]**

When ON is selected, the box cursor is output to the screen center. When the image of the subject's skin is placed inside the box cursor and the ENTER operation is performed, I CENTER and Q PHASE are set automatically.

#### **SKIN DTL CORING [0 to 7]**

For setting the SKIN TONE DTL coring amount.

#### **Y MAX [000 to 255]**

For setting the upper limit of the brightness in the skin tone specification area.

#### **Y MIN [000 to 255]**

For setting the lower limit of the brightness in the skin tone specification area.

#### **I CENTER [000 to 255]**

For setting the phase of the I axis in the skin tone specification area.

#### **I WIDTH [000 to 255]**

For setting the phase width of the I axis in the skin tone specification area.

#### **Q WIDTH [000 to 255]**

For setting the phase range of the Q axis in the skin tone specification area.

#### **Q PHASE [-128 to +127]**

For setting the phase of the Q axis in the skin tone specification area.

# Setting of menu items

---

## ① MAINTENANCE menu

### [8] GAIN, AUTO IRIS

```
*** GAIN,AUTO IRIS **  
  
LOW GAIN      :+00dB  
MID GAIN      :+09dB  
HIGH GAIN     :+18dB  
A.IRIS LEVEL  :075  
A.IRIS PEAK/AVE :050  
A.IRIS WINDOW :NORM1  
IRIS MODE     :LENS  
IRIS GAIN     :05
```

#### **LOW GAIN [-06dB to 30dB]**

#### **MID GAIN [-06dB to 30dB]**

#### **HIGH GAIN [-06dB to 30dB]**

For setting the amount by which the gain is to be increased when LOW, MID or HIGH has been selected by GAIN SELECT.

#### **A.IRIS LEVEL [000 to 100]**

For adjusting the target level (brightness) of the auto iris.

#### **A.IRIS PEAK/AVE [000 to 100]**

For setting the ratio between the auto iris light-metering peak value and average value.

#### **A.IRIS WINDOW [NORM1, NORM2, CENTR]**

For setting the auto iris light-metering area.

NORM1: The light is metered on the entire screen (except around the edges).

NORM2: The light is metered on the entire screen (except at the top).

CENTR: The light is metered only in the area at the screen center.

#### **IRIS MODE [LENS, CAM]**

For switching between the iris gain control on the lens (LENS) and the menu (CAM) to adjust the focusing speed of the auto iris. Normally, LENS is selected, and the speed is adjusted using the iris gain control on the lens.

#### **IRIS GAIN [01 to 10]**

For adjusting the iris gain when CAM has been selected as the IRIS MODE setting.

# Setting of menu items

---

## ① MAINTENANCE menu

### [9] SUPER GAIN

```
---** S.GAIN(1/2) ** S.GAIN1
MODE                :S.GAIN1
*TOTAL GAIN         : 30dB
GAIN                : 18dB
PIX MIX             : +6dB
V MIX               : +6dB
FRAME MIX           : OFF
H DETAIL LEVEL      : 10
CRISP                : 10
LEVEL DEPENDENT     : 05
PEAK FREQUENCY      : 10
```

These settings are performed when S.GAIN1, S.GAIN2 or S.GAIN3 has been selected by GAIN SELECT.

#### **MODE [S.GAIN1, S.GAIN2, S.GAIN3]**

For selecting the S.GAIN storage table.

#### **TOTAL GAIN [00dB to 72dB]**

For displaying the total gain for GAIN, PIX MIX, V MIX and FRAME MIX.

#### **GAIN [00dB to 36dB]**

For setting the gain increase.  
(The increase is set in increments of 3 dB.)

#### **PIX MIX [OFF, +6dB]**

For setting the addition of horizontal pixels ON or OFF.

#### **V MIX [OFF, +6dB]**

For setting the addition of vertical pixels ON or OFF.

#### **FRAME MIX [OFF, 06dB to 24dB]**

For setting the gain increase based on accumulation in the CCD image sensor.  
(The increase is set in increments of 6 dB.)

#### **H DETAIL LEVEL [00 to 63]**

For setting the H DETAIL level.

#### **CRISP [00 to 31]**

For setting the noise elimination level of the detail signals.



# Setting of menu items

---

## ① MAINTENANCE menu

### [9] SUPER GAIN

```
---** S.GAIN(1/2) ** S.GAIN1
MODE : S.GAIN1
*TOTAL GAIN : 30dB
GAIN : 18dB
PIX MIX : +6dB
V MIX : +6dB
FRAME MIX : OFF
H DETAIL LEVEL : 10
CRISP : 10
LEVEL DEPENDENT : 05
PEAK FREQUENCY : 10
```

```
---** S.GAIN(2/2) ** S.GAIN1
M GAMMA : 0.50
M PED OFFSET : +000
R PED OFFSET : +000
B PED OFFSET : +000
```

### LEVEL DEPENDENT [00 to 15]

For removing the detail in the dark areas.  
The higher the number set, the wider the range in which the detail is removed.

### PEAK FREQUENCY [00 to 31]

For setting the H DTL peak frequency.

### M GAMMA

[0.35 to 0.75 (DRS OFF)]

[-10 to +10 (DRS ON)]

For adjusting the gamma characteristics.

### M PED OFFSET [-200 to +200]

For adjusting the amount of offset in the black level.

### R PED OFFSET [-200 to +200]

For adjusting the amount of offset in the R pedestal.

### B PED OFFSET [-200 to +200]

For adjusting the amount of offset in the B pedestal.

# Setting of menu items

---

## ① MAINTENANCE menu

### [10] FRAME MODE

```
*** FRAME MODE **  
  
SCAN REVERSE      : OFF
```

### SCAN REVERSE [OFF, REVERSE1 to 3]

For selecting the video output scanning method.

- OFF: Normal scanning
- REVERSE1: Left/right reversed
- REVERSE2: Top/bottom reversed
- REVERSE3: Top/bottom and left/right reversed

### [11] MATRIX

```
*** MATRIX **  
  
MATRIX TABLE      : A  
MATRIX R-G         : +00  
MATRIX R-B         : +00  
MATRIX G-R         : +00  
MATRIX G-B         : +00  
MATRIX B-R         : +00  
MATRIX B-G         : +00
```

### MATRIX TABLE [A, B]

For selecting the table in which the matrix data is to be stored.

- MATRIX R-G [-31 to +31]**
- MATRIX R-B [-31 to +31]**
- MATRIX G-R [-31 to +31]**
- MATRIX G-B [-31 to +31]**
- MATRIX B-R [-31 to +31]**
- MATRIX B-G [-31 to +31]**

For adjusting the color tone of each color phase.

# Setting of menu items

---

## ① MAINTENANCE menu

### [12] COLOR CORRECTION

- ** COLOR CORRECTION (1/2) **		
	SAT	PHASE
R	+00	+00
Mg	+00	+00
B	+00	+00
Cy	+00	+00
G	+00	+00
Yl	+00	+00

- ** COLOR CORRECTION (2/2) **		
	SAT	PHASE
R-Mg	+00	+00
Mg-B	+00	+00
B-Cy	+00	+00
Cy-G	+00	+00
G-Yl	+00	+00
Yl-R	+00	+00

- R SAT/PHASE [-63 to +63]
- Mg SAT/PHASE [-63 to +63]
- B SAT/PHASE [-63 to +63]
- Cy SAT/PHASE [-63 to +63]
- G SAT/PHASE [-63 to +63]
- Yl SAT/PHASE [-63 to +63]
- R-Mg SAT/PHASE [-63 to +63]
- Mg-B SAT/PHASE [-63 to +63]
- B-Cy SAT/PHASE [-63 to +63]
- Cy-G SAT/PHASE [-63 to +63]
- G-Yl SAT/PHASE [-63 to +63]
- Yl-R SAT/PHASE [-63 to +63]

For adjusting the color tone of each color phase.

# Setting of menu items

---

## ② SETTING menu

```
--* SETTING *  
  
1.MODE  
2.SHUTTER  
3.GEN-LOCK  
4.PROTOCOL  
5.INTELLIGENT1  
6.INTELLIGENT2  
7.INTELLIGENT SET
```

### [1] MODE

```
--* MODE(1/2) **  
  
D5600K :OFF  
GAIN SELECT :LOW  
CAM ID :OFF  
CAM ID POSI :1  
MATRIX TABLE :OFF  
COLOR CORRECTION :OFF  
DIGITAL EXTENDER :OFF  
BAR SEL :FULL(16:9)  
FORMAT :1080/59.94i
```

**When the VIDEO MENU is selected  
D5600K [OFF, ON]**

**When the FILM MENU is selected  
LIGHTING [TUNGSTEN, DAYLIGHT]**

**ON, DAYLIGHT:**

The color temperature is corrected electrically to attain white balance in 5600K-degree environments.

**OFF, TUNGSTEN:**

The color temperature is corrected electrically to attain white balance in 3200K-degree environments.

### **GAIN SELECT**

**[LOW, MID, HIGH, S.GAIN1 to 3]**

For selecting LOW, MID, HIGH, S.GAIN1, S.GAIN2 or S.GAIN3 as the gain setting.

### **CAM ID [OFF, BAR, ON]**

For selecting how the camera ID is to be displayed.

**OFF:** The camera ID is not displayed.

**BAR:** The camera ID is displayed only in the color bar mode.

**ON:** The camera ID is displayed at all times.

# Setting of menu items

## ② SETTING menu

### [1] MODE

```
---** MODE(1/2) **  
  
D5600K           :OFF  
GAIN SELECT      :LOW  
CAM ID           :OFF  
CAM ID POSI      :1  
MATRIX TABLE    :OFF  
COLOR CORRECTION :OFF  
DIGITAL EXTENDER :OFF  
BAR SEL          :FULL(16:9)  
FORMAT          :1080/59.94i
```

### CAM ID POSI [0 to 3]

For selecting where the camera ID is to be displayed.

0: top left, 1: top right, 2: bottom left, 3: bottom right

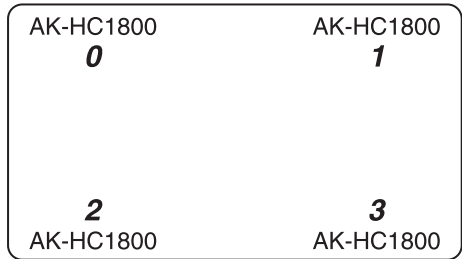

### MATRIX TABLE [OFF, A, B]

For selecting OFF, A or B as the matrix setting.

### COLOR CORRECTION [OFF, ON]

For turning the color correction function ON or OFF.

### DIGITAL EXTENDER [OFF, X2]

For digitally doubling the images when set to X2.

### BAR SEL

[FULL (16:9), FULL (4:3), SMPTE (16:9), SMPTE (4:3), ARIB]

For selecting the color bars.

Select the 4:3 color bars for down-conversion at the system side. The color bars and characters will then be contained within the 4:3 picture angle.

### Note

When DIGITAL EXTENDER is set to X2, the resolution is downgraded. The detail function ceases to work as well.

# Setting of menu items

---

## ② SETTING menu

### [1] MODE

```
---** MODE(1/2) **  
  
D5600K           :OFF  
GAIN SELECT      :LOW  
CAM ID           :OFF  
CAM ID POSI      :1  
MATRIX TABLE    :OFF  
COLOR CORRECTION :OFF  
DIGITAL EXTENDER :OFF  
BAR SEL          :FULL(16:9)  
FORMAT           :1080/59.94i
```

### FORMAT

For displaying the video output format.  
(1080/59.94i)

```
---** MODE(2/2) **  
  
STATUS           :OFF  
MENU ON BAR      :ON  
MENU SEL         :VIDEO MENU  
FAN              :AUTO
```

### STATUS [OFF, ON]

For turning the AWB/ABB operation displays ON or OFF.

The status displays are as follows.

#### AWB ACTIVE:

While automatic white balance is being executed.

#### AWB OK:

When the automatic white balance has been adjusted satisfactorily.

#### OUT RANGE RB:

When the automatic white balance has not been adjusted satisfactorily. ("RB" denotes the colors which were not balanced properly.)

#### HIGH LIGHT NG:

When the lighting is too high.

#### LOW LIGHT NG:

When the lighting is too low.

#### ABB ACTIVE:

While automatic black balance is being executed.

#### IRIS CONTROL NG:

When the lens is open.

# Setting of menu items

---

## ② SETTING menu

### [1] MODE

```
---** MODE (2/2) **---  
  
STATUS           :OFF  
MENU ON BAR     :ON  
MENU SEL        :VIDEO MENU  
FAN              :AUTO
```

### ABB OK:

When the automatic black balance has been adjusted satisfactorily.

### OUT RANGE RGB:

When the automatic black balance has not been adjusted satisfactorily.

(“RGB” denotes the colors which were not balanced properly.)

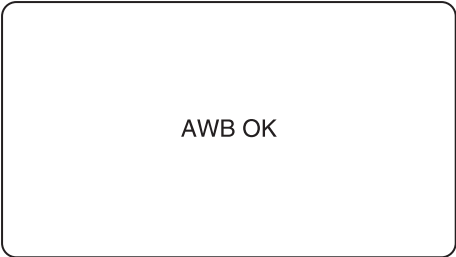

### MENU ON BAR [OFF, ON]

For selecting whether the menu is to be displayed with the color bars. Switching from ON to OFF or vice versa is not possible when color bars have been set.

### MENU SEL [VIDEO MENU, FILM MENU]

For selecting the menu display.

### FAN [OFF, AUTO, ON]

For selecting the operation mode of the air-cooled fan.

- OFF: The fan is always off.
- AUTO: The fan is automatically controlled by the temperature sensor.
- ON: The fan is running at all times.

At the FAN OFF setting, ensure that the product is operated in an ambient temperature below 86 °F (30 °C).

# Setting of menu items

---

## ② SETTING menu

### [2] SHUTTER

```
---** SHUTTER **  
  
SHUTTER MODE      :OFF  
SHUTTER SPEED     :1/100  
SYNCHRO SCAN      :91.13Hz
```

#### SHUTTER MODE [OFF, ON, SYNCHRO]

For selecting the operation mode of the shutter.

- OFF: For turning the shutter OFF.
- ON: For setting the shutter speed which was set by SHUTTER SPEED.
- SYNCHRO: For setting the shutter speed which was set by SYNCHRO SCAN.

#### SHUTTER SPEED

[1/100, 1/120, 1/250, 1/500, 1/1000, 1/2000 (VIDEO MENU)]

[180.0 deg, 172.8 deg, 144.0 deg, 120.0 deg, 90.0 deg, 45.0 deg (FILM MENU)]

For setting the shutter speed at the SHUTTER ON setting.

#### SYNCHRO SCAN

[60.32 Hz to 149.2 Hz]

[356.4 deg to 144.0 deg (FILM MENU)]

For setting the shutter speed in the synchro scanning mode.



# Setting of menu items

---

## ② SETTING menu

### [3] GEN-LOCK

```
*** GEN-LOCK **  
  
GEN-LOCK INPUT      :BNC  
H PHASE-COARSE      :+000  
H PHASE FINE        :+000  
SD-HD PHASE CRS     :+0  
SD-HD PHASE FINE    :+00
```

#### **GEN-LOCK INPUT [BNC, DSUB]**

For selecting whether the sync signals are to be input from the BNC or D-SUB connector.

#### **H PHASE-COARSE**

**[-060 to +060]**

For roughly adjusting the horizontal phase.

#### **H PHASE-FINE [-045 to +045]**

For finely adjusting the horizontal phase.

#### **SD-HD PHASE CRS [-4 to +4]**

For roughly adjusting the phase of the HD video signals when SD sync signals have been input.

#### **SD-HD PHASE FINE [-99 to +99]**

For finely adjusting the phase of the HD video signals when SD sync signals have been input.

# Setting of menu items

---

## ② SETTING menu

### [4] PROTOCOL

```
---** PROTOCOL **  
  
PROTOCOL           :1
```

### PROTOCOL [1 to 4]

For selecting the remote control communication system in accordance with the system connected.

- 1:** Information camera communication protocol (EIA422)  
For connecting the AK-HRP150G or AK-HRP900  
(With the AK-HRP900, this setting cannot be used at a baud rate of 9600 bps.)
- 2:** Information camera communication protocol (EIA232)  
For connecting a PC  
(This setting cannot be used at a baud rate of 9600 bps.)
- 3:** Convertible PC control protocol (EIA422)  
For connecting the AW-CB400  
(baud rate fixed at 9600 bps)
- 4:** Convertible PC control protocol (EIA232) For connecting the AW-PH400 pan/tilt head (baud rate fixed at 9600 bps)

The protocol is actually switched after the power has been turned off and back on.

# Setting of menu items

---

## ② SETTING menu

### [5] INTELLIGENT1

```
---** INTELLIGENT1 (1/2) **  
M-GAIN: 0dB ND-FIL: CLEAR  
  
INTELLIGENT      : AUTO  
INTELLIGENT MODE : AGC+ATW  
ND FILTER SELECT : AUTO  
AGC SPEED        : 3  
AGC GAIN STEP    : NORMAL  
HI LIGHT DETECT  : 05  
IRIS RANGE       : 2  
ATW AREA         : 90%  
ATW SPEED        : 3  
D5600K           : ON
```

#### M-GAIN [-6dB to 72dB]

The current gain total is displayed here.

#### ND-FIL [CLEAR, 1/4, 1/16, 1/64]

The current ND filter position is displayed here.

#### INTELLIGENT

##### [MANUAL, AUTO, LOCK]

The operation mode for intelligent control is set here.

**AUTO:** AGC and ATW are adjusted automatically.

**LOCK:** The status of the AGC and ATW adjustments is held as soon as the INTELLIGENT item setting is changed from AUTO to LOCK.

**MANUAL:** Intelligent control is operated using the settings selected from the regular menus and camera controller.

When AUTO or LOCK is set on the INTELLIGENT1 menu, INTELLIGENT2 is set to MANUAL.

Similarly, when AUTO or LOCK is set on the INTELLIGENT2 menu, INTELLIGENT1 is set to MANUAL.

The INTELLIGENT SET menu settings are also switched in tandem.

# Setting of menu items

---

## ② SETTING menu

### [5] INTELLIGENT1

```
---** INTELLIGENT1 (1/2) **
M-GAIN: 0dB ND-FIL: CLEAR

INTELLIGENT      : AUTO
INTELLIGENT MODE : AGC+ATW
ND FILTER SELECT : AUTO
AGC SPEED        : 3
AGC GAIN STEP    : NORMAL
HI LIGHT DETECT  : 05
IRIS RANGE       : 2
ATW AREA         : 90%
ATW SPEED        : 3
D5600K           : ON
```

When AUTO or LOCK has been set as the operation mode, restrictions apply to the settings of some of the other menus, as indicated below.

#### AGC

- The auto iris function is operational regardless of whether the auto iris setting from the camera controller is ON or OFF.
- The setting from the menu and camera controller is not reflected for GAIN SELECT on the SETTING menu.
- The LOW GAIN, MID GAIN, and HIGH GAIN settings for GAIN/AUTO IRIS on the MAINTENANCE menu are not reflected.
- The S.GAIN settings (gain, detail, gamma, and pedestal settings) on the MAINTENANCE menu are not reflected.
- The ND FILTER setting for R/B GAIN on the MAINTENANCE menu is not reflected.

#### ATW

- R/B GAIN can be controlled from the menu and camera controller, but the white balance is automatically adjusted if the subject is identified as being white.
- AWB is executed in a 25 % × 25 % area at the center regardless of the ATW AREA setting. However, what is determined to be the ATW color temperature is not always consistent with AWB, so the white balance may be changed by ATW after AWB has been executed.

# Setting of menu items

---

## ② SETTING menu

### [5] INTELLIGENT1

```
---** INTELLIGENT1 (1/2) **  
M-GAIN: 0dB ND-FIL: CLEAR  
  
INTELLIGENT      : AUTO  
INTELLIGENT MODE : AGC+ATW  
ND FILTER SELECT : AUTO  
AGC SPEED        : 3  
AGC GAIN STEP    : NORMAL  
HI LIGHT DETECT  : 05  
IRIS RANGE       : 2  
ATW AREA         : 90%  
ATW SPEED        : 3  
D5600K          : ON
```

### INTELLIGENT MODE

#### [AGC, ATW, AGC+ATW]

The intelligent control setting is selected using this menu item.

- AGC: When the gain cannot be adjusted within the IRIS RANGE setting, gain control (including PIX MIX, V MIX, and FRAME MIX) and automatic exposure control performed by adjusting the ND filter setting are executed.
- ATW: When the subject is identified as being white, the white balance is adjusted automatically.

AGC+ATW: The above AGC and ATW adjustments are performed at the same time.

### ND FILTER SELECT

#### [CLEAR, 1/4, 1/16, 1/64, AUTO]

The ND filter setting during AGC operations is selected using this menu item.

AUTO: Depending on the light quantity, the ND filter is adjusted to the appropriate position.

CLEAR, 1/4, 1/16, 1/64:

The specified ND filter setting is fixed.

During AGC operations, control cannot be exercised from the camera controller.

### AGC SPEED [1 to 5]

The AGC convergence speed can be set to any of 5 levels here.

The speed becomes faster as the figure increases.

# Setting of menu items

---

## ② SETTING menu

### [5] INTELLIGENT1

```
---** INTELLIGENT1 (1/2) **
      M-GAIN: 0dB ND-FIL: CLEAR

INTELLIGENT      : AUTO
INTELLIGENT MODE : AGC+ATW
ND FILTER SELECT : AUTO
AGC SPEED        : 3
AGC GAIN STEP    : NORMAL
HI LIGHT DETECT  : 05
IRIS RANGE       : 2
ATW AREA         : 90%
ATW SPEED        : 3
D5600K           : ON
```

#### **AGC GAIN STEP [NORMAL, MAX]**

The AGC gain increment or decrement step is selected using this menu item.

**NORMAL:** In the case of underexposure, the gain is incremented from 0 dB to AGC MAX GAIN in very small steps. Conversely, in the case of overexposure, it is decremented from AGC MAX GAIN to 0 dB in very small steps.

**MAX:** In the case of underexposure, the gain is incremented straight from 0 dB to AGC MAX GAIN. Conversely, in the case of overexposure, it is decremented straight from AGC MAX GAIN to 0 dB. When MAX is selected, set AGC MAX GAIN in such a way that the lens iris adjustment range is not exceeded. (If it is set so that this range is exceeded, iris hunting may occur.)

#### **HI LIGHT DETECT [01 to 10]**

When the effective image is exposed to the light from a spotlight, one of 10 levels for ignoring the effect of the light can be selected.

The reaction to the light from the spotlight becomes greater as the figure increases.

# Setting of menu items

## ② SETTING menu

### [5] INTELLIGENT1

```
---** INTELLIGENT1 (1/2) **  
M-GAIN: 0dB ND-FIL: CLEAR  
  
INTELLIGENT      : AUTO  
INTELLIGENT MODE : AGC+ATW  
ND FILTER SELECT : AUTO  
AGC SPEED        : 3  
AGC GAIN STEP    : NORMAL  
HI LIGHT DETECT  : 05  
IRIS RANGE       : 2  
ATW AREA         : 90%  
ATW SPEED        : 3  
D5600K          : ON
```

### IRIS RANGE [1, 2, 3]

The iris control range during AGC operations is selected using this menu item.

- 1: F1.8 to F8
- 2: F1.8 to F11
- 3: F1.8 to F16

When the iris cannot be adjusted within the above range settings, use the gain (including PIX MIX, V MIX, and FRAME MIX), ND filter, and minus gain settings to adjust the range so that the appropriate level of exposure is achieved.

### ATW AREA [25%, 50%, 90%]

The ATW white detection range is selected here.

The range is set to an area that is approximately 25 %, approximately 50 %, or approximately 90 % of the horizontal and vertical angles of view from the screen center, respectively.

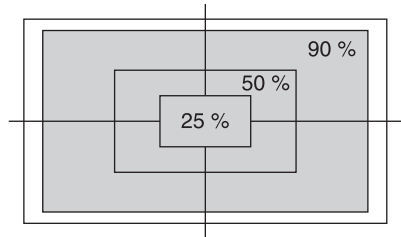

### ATW SPEED [1 to 5]

The ATW convergence speed can be set to any of 5 levels here.

The speed becomes faster as the figure increases.

# Setting of menu items

---

## ② SETTING menu

### [5] INTELLIGENT1

```
---** INTELLIGENT1 (1/2) **  
M-GAIN: 0dB ND-FIL: CLEAR  
  
INTELLIGENT      : AUTO  
INTELLIGENT MODE : AGC+ATW  
ND FILTER SELECT : AUTO  
AGC SPEED        : 3  
AGC GAIN STEP    : NORMAL  
HI LIGHT DETECT  : 05  
IRIS RANGE       : 2  
ATW AREA         : 90%  
ATW SPEED        : 3  
D5600K           : ON
```

```
---** INTELLIGENT1 (2/2) **  
M-GAIN: 0dB ND-FIL: CLEAR  
  
AGC MODE          : USER  
AGC MAX GAIN      : +09dB (15dB)  
PIX MIX           : +06dB  
V MIX             : +00dB  
FRAME MIX        : +00dB  
SUB MENU
```

### D5600K [OFF, ON]

The ATW center value is set using this item.

OFF: 3200K

ON: 5600K

The respective ATW tracking ranges are set using ATW WIDTH on the INTELLIGENT SET menu.

### AGC MODE

#### [NORMAL, SPORTS, SN, USER]

The AGC control mode is set here.

**NORMAL:**

The gain is incremented up to +18 dB by AGC control.

**SPORTS:**

This setting is for exercising control that is ideally suited to fast-moving images.

The gain is incremented in the following sequence: +18 dB for AGC → +6 dB for PIX MIX → +6 dB for V MIX.

**SN:**

This setting is for exercising control that gives priority to SN.

The gain is incremented in the following sequence: +24 dB for FRAME MIX → +6 dB for PIX MIX → +6 dB for V MIX.

**USER:**

The gain is incremented in the sequence set using SUB MENU.

When the AGC MODE setting is changed, intelligent control is exercised from the initial status inside the camera. Therefore, immediately after this change is made, the image may become dark or light, and the color temperature may change.



# Setting of menu items

---

## ② SETTING menu

### [5] INTELLIGENT1

```
---** INTELLIGENT1 (2/2) **  
M-GAIN: 0dB ND-FIL: CLEAR  
  
AGC MODE           : USER  
AGC MAX GAIN       : +09dB (15dB)  
PIX MIX            : +06dB  
V MIX              : +00dB  
FRAME MIX          : +00dB  
SUB MENU
```

#### **AGC MAX GAIN [+00dB to +36dB]**

The maximum gain increment for AGC is displayed here. Inside the parentheses on the right is the maximum gain increment, which is obtained by adding the values for PIX MIX, V MIX, and FRAME MIX.

#### **PIX MIX [+00dB, +06dB]**

The extent of the horizontal pixel addition is displayed here.

- +00dB: No horizontal pixels are added.
- +06dB: The sensitivity is doubled over the +00 dB setting. However, the horizontal resolution is reduced to half.

#### **V MIX [+00dB, +06dB]**

The extent of the vertical pixel addition is displayed here.

- +00dB: No vertical pixels are added.
- +06dB: The sensitivity is doubled over the +00 dB setting. However, the vertical resolution is reduced to half.

#### **FRAME MIX**

#### **[+00dB, +06dB, +12dB, +18dB, +24dB]**

The extent of the frame addition (incrementing of gain by CCD storage) is displayed here.

- +00dB: No frames are added.
- +06dB to +24dB:
  - 2 frames are added with +06 dB,
  - 4 frames are added with +12 dB,
  - 8 frames are added with +18 dB
  - and 16 frames are added with +24 dB, with the sensitivity increasing at each setting.
  - However, the phenomenon of residual image increases.

# Setting of menu items

## ② SETTING menu

### [5] INTELLIGENT1

```

-**- INTELLIGENT1 (2/2) **-
  M-GAIN: 0dB ND-FIL: CLEAR

AGC MODE           : USER
AGC MAX GAIN       : +09dB (15dB)
PIX MIX            : +06dB
V MIX              : +00dB
FRAME MIX          : +00dB
SUB MENU
  
```

```

-**- INTELLIGENT1 (1/2) **-
  AGC USER MODE

                0 18 36 54 72
No TYPE        +--+--+--+--+
01-AGC : 09dB ( 9) .|||.....
02 PMIX: 06dB (15) .||.....
03 --- : 00dB (00) .....
04 --- : 00dB (00) .....
05 --- : 00dB (00) .....
06 --- : 00dB (00) .....
07 --- : 00dB (00) .....
08 --- : 00dB (00) .....
09 --- : 00dB (00) .....
  
```

### SUB MENU

When USER has been selected as the AGC MODE setting, the type of gain, gain increment step, and priority sequence can be set in detail.

The gain is incremented in the sequence of No.01, 02, 03 and so on. It can be set up to No.18. (No.10 to 18 are displayed on page 2/2.)

When NORMAL, SPORTS, or SN has been selected as the control mode setting, only a display appears.

Move the cursor to TYPE for each number, set the gain type, and then move the cursor to the numbers on the right and set the gain increment step. Inside the parentheses on the right of the setting is the total gain.

The gain can be set in 3 dB increments for AGC up to a maximum of +36 dB, in 6 dB increments for PMIX and VMIX, and in 6 dB increments for FMIX up to a maximum of +24 dB.

If the TYPE setting selected is changed to “---”, the subsequent settings will be deleted.

# Setting of menu items

---

## ② SETTING menu

### [6] INTELLIGENT2

```
-** INTELLIGENT2 (1/2) **  
M-GAIN: 0dB ND-FIL: CLEAR  
  
INTELLIGENT      : AUTO  
INTELLIGENT MODE : AGC+ATW  
ND FILTER SELECT : AUTO  
AGC SPEED        : 3  
AGC GAIN STEP    : NORMAL  
HI LIGHT DETECT  : 05  
IRIS RANGE       : 2  
ATW AREA         : 90%  
ATW SPEED        : 3  
D5600K           : ON
```

This menu is configured in the same way as the INTELLIGENT1 menu.

```
-** INTELLIGENT2 (2/2) **  
M-GAIN: 0dB ND-FIL: CLEAR  
  
AGC MODE          : USER  
AGC MAX GAIN      : +09dB(15dB)  
PIX MIX           : +06dB  
V MIX             : +00dB  
FRAME MIX         : +00dB  
SUB MENU
```

# Setting of menu items

---

## ② SETTING menu

### [7] INTELLIGENT SET

```
---** INTELLIGENT SET **  
  
INTELLIGENT      :INTEL1  
ATW WIDTH        :5  
IRIS ON LOCK     :MANUAL
```

### **INTELLIGENT [INTEL1, INTEL2, OFF]**

Intelligent mode OFF, INTEL1 (INTELLIGENT1 menu setting), or INTEL2 (INTELLIGENT2 menu setting) is selected as the operation mode. When the setting of this item is changed, the settings for the INTELLIGENT items on the INTELLIGENT1 and INTELLIGENT2 menus are also changed in tandem.

- OFF:     MANUAL is set for INTELLIGENT1 and INTELLIGENT2.
- INTEL1:  AUTO is set for INTELLIGENT1 and MANUAL for INTELLIGENT2.
- INTEL2:  MANUAL is set for INTELLIGENT1 and AUTO for INTELLIGENT2.

# Setting of menu items

## ② SETTING menu

### [7] INTELLIGENT SET

```
---** INTELLIGENT SET **  
  
INTELLIGENT      :INTEL1  
ATW WIDTH        :5  
IRIS ON LOCK     :MANUAL
```

### ATW WIDTH [1 to 5]

The color temperature range (1 to 5) used for tracking ATW is set here.

With D5600K OFF, the range is set centering on 3200K or so; with D5600K ON, it is set centering on 5600K or so.

The general color temperature tracking ranges are listed in the table below.

ATW WIDTH	D5600K OFF	D5600K ON
1	Approx. 3000K to 4000K	Approx. 4500K to 7000K
2	Approx. 2500K to 5000K	Approx. 4000K to 8000K
3	Approx. 2400K to 8000K	Approx. 2500K to 9500K
4	Approx. 1900K to 10000K	Approx. 2400K to 10500K
5	Approx. 1600K to 11000K	Approx. 1600K to 11000K

### IRIS ON LOCK

#### [LOCK, MANUAL, PANEL]

The IRIS operation status when the intelligent functions are locked is selected here.

LOCK: The iris is held in the lock start status.

MANUAL: The iris is switched to manual operation.

PANEL: Control that is exercised from the camera controller switches the iris operation between IRIS AUTO and MANUAL.

# Setting of menu items

---

## ③ CAMERA ID menu

```
-* CAMERA ID *  
  
ID:AK-HC1800
```

An ID of not more than 10 characters consisting of alphanumerics, symbols and spaces can be set for the camera. The camera ID is displayed at all times when ON is selected in the CAM ID mode but displayed only when color bar signals are output in the BAR mode. The status for setting the ID is established by moving the cursor above the colon (:) and selecting it. Move the cursor to the positions of the characters to be set, select the characters and enter them.

**Characters which can be entered:**  
Spaces, upper-case letters (A to Z), numbers (0 to 9), and symbols ( ' , > , < , / , - )

# Setting of menu items

---

## ④ FILE OPERATION menu

```
* FILE OPERATION *  
  
-MODE                :LOAD  
LOAD FROM            :USER1  
EXECUTE
```

### MODE [LOAD/STORE]

Select LOAD when settings are to be loaded from a file; select STORE when the current settings are to be saved in a file.

```
* FILE OPERATION *  
  
-MODE                :STORE  
STORE TO             :USER1  
EXECUTE
```

### LOAD/STORE FROM

For selecting the LOAD or STORE destination.

PRESET, USER1 or USER2 can be selected as the LOAD destination when LOAD has been selected; USER1 or USER2 can be selected as the STORE destination when STORE has been selected.

```
* FILE OPERATION *  
  
  
  
  
  
  
  
  
  
LOAD OK?  
YES  
- NO
```

### EXECUTE

When EXECUTE is selected, the "LOAD OK?" or "STORE OK?" message is displayed.

LOAD or STORE is executed when NO is switched to YES and the ENTER operation is performed.

"COMPLETE" is displayed after the data has been loaded or stored.

# Setting of menu items

## ■ Menu list

			Scene file items indicated by "✓"
MAINTENANCE	1.BLACK SHADING	DETECTION	—
		CORRECT(DIG)	—
	2.PEDESTAL, GAMMA	M PEDESTAL	✓
		R PEDESTAL	✓
		B PEDESTAL	✓
		M GAMMA	✓
		R GAMMA	✓
		B GAMMA	✓
		M BLACK GAMMA	✓
		R BLACK GAMMA	✓
		B BLACK GAMMA	✓
		GAMMA	✓
		BLACK GAMMA	✓
		EFFECT DEPTH	✓
		DRS	✓
		CINE GAMMA SELECT	✓
	BLACK STR.LEVEL	✓	
	DYNAMIC LEVEL	✓	
	3.FLARE	R FLARE	✓
		G FLARE	✓
		B FLARE	✓
		FLARE	✓
	4.KNEE, WHITE CLIP	M KNEE POINT	✓
		R KNEE POINT	✓
		B KNEE POINT	✓
		M KNEE SLOPE	✓
		R KNEE SLOPE	✓
		B KNEE SLOPE	✓
		A.KNEE POINT	✓
		A.KNEE LEVEL	✓
		M WHITE CLIP LVL	✓
		R WHITE CLIP LVL	✓
		B WHITE CLIP LVL	✓
		KNEE	✓
		WHITE CLIP	✓
	HIGH COLOR	✓	
	5.R/B GAIN	R GAIN	✓
		B GAIN	✓
		ND FILTER	✓
	6.DETAIL	DETAIL	✓
		TOTAL DTL LEVEL	✓
		H DTL LEVEL	✓
		CRISP	✓
		LEVEL DEPENDENT	✓
		PEAK FREQUENCY	✓
		KNEE APERTURE	✓
	KNEE APE LEVEL	✓	



# Setting of menu items

			Scene file items indicated by "✓"
MAINTENANCE	6.DETAIL	SLIM DETAIL	✓
		DETAIL(+)	✓
		DETAIL(-)	✓
		DETAIL CLIP	✓
		DETAIL SOURCE	✓
	7.SKIN TONE DTL	SKIN TONE DTL	✓
		SKIN GET	✓
		SKIN DTL CORING	✓
		Y MAX	✓
		Y MIN	✓
		I CENTER	✓
		I WIDTH	✓
		Q WIDTH	✓
		Q PHASE	✓
	8.GAIN,AUTO IRIS	LOW GAIN	✓
		MID GAIN	✓
		HIGH GAIN	✓
		A.IRIS LEVEL	✓
		A.IRIS PEAK/AVE	✓
		A.IRIS WINDOW	✓
		IRIS MODE	—
		IRIS GAIN	—
	9.S.GAIN	MODE	—
		TOTAL GAIN	—
		GAIN	✓
		PIX MIX	✓
		V MIX	✓
		FRAME MIX	✓
		H DETAIL LEVEL	✓
		CRISP	✓
		LEVEL DEPENDENT	✓
		PEAK FREQUENCY	✓
		M GAMMA	✓
		M PED OFFSET	✓
		R PED OFFSET	✓
	B PED OFFSET	✓	
	10.FRAME MODE	SCAN REVERSE	—
	11.MATRIX	MATRIX TABLE	✓
		MATRIX R-G	✓
		MATRIX R-B	✓
		MATRIX G-R	✓
		MATRIX G-B	✓
		MATRIX B-R	✓
		MATRIX B-G	✓

# Setting of menu items

			Scene file items indicated by "✓"
MAINTENANCE	12.COLOR CORRECTION	R SAT/PHASE	✓
		Mg SAT/PHASE	✓
		B SAT/PHASE	✓
		Cy SAT/PHASE	✓
		G SAT/PHASE	✓
		Yl SAT/PHASE	✓
		R_Mg SAT/PHASE	✓
		Mg_B SAT/PHASE	✓
		B_Cy SAT/PHASE	✓
		Cy_G SAT/PHASE	✓
		G_Yl SAT/PHASE	✓
		Yl_R SAT/PHASE	✓
SETTING	1.MODE	D5600K	✓
		LIGHTING	✓
		GAIN SELECT	✓
		CAM ID	—
		CAM ID POSI	—
		MATRIX TABLE	✓
		COLOR CORRECTION	✓
		DIGITAL EXTENDER	—
		BAR SEL	—
		FORMAT	—
		STATUS	—
		MENU ON BAR	—
		MENU SEL	—
		FAN	—
		2.SHUTTER	SHUTTER MODE
	SHUTTER SPEED		✓
	SYNCHRO SCAN		✓
	3.GEN-LOCK	GEN-LOCK INPUT	—
		H PHASE-COARSE	—
		H PHASE-FINE	—
		SD-HD PHASE CRS	—
		SD-HD PHASE FINE	—
	4.PROTOCOL	PROTOCOL	—

# Setting of menu items

			Scene file items indicated by "✓"
SETTING	5.INTELLIGENT1 6.INTELLIGENT2	INTELLIGENT	—
		INTELLIGENT MODE	—
		ND FILTER SELECT	—
		AGC SPEED	—
		AGC GAIN STEP	—
		HI LIGHT DETECT	—
		IRIS RANGE	—
		ATW AREA	—
		ATW SPEED	—
		D5600K	—
		AGC MODE	—
		AGC MAX GAIN	—
		PIX MIX	—
		V MIX	—
		FRAME MIX	—
		SUB MENU	—
		7.INTELLIGENT SET	INTELLIGENT
		ATW WIDTH	—
	IRIS ON LOCK	—	
CAMERA ID	ID:		—

When a scene file is loaded, there may be inconsistencies in some of the items between the status of the connected controller and the status of the camera.

When the controller is operated in this status, the status of the controller will be reflected.

# Appearance

Unit: inch (mm)

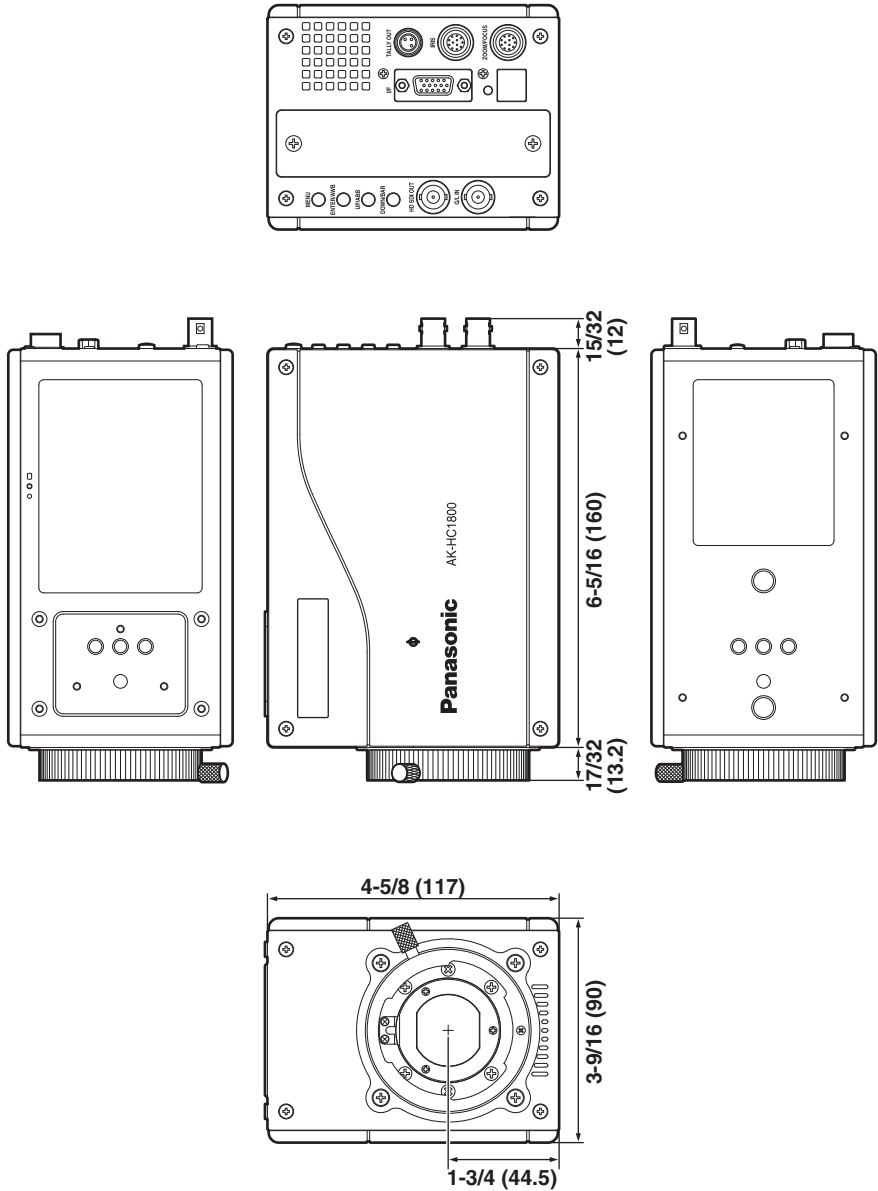

# Specifications

---

<b>Source voltage:</b>	12 V DC
<b>Power consumption:</b>	17 W

 indicates safety information.

**Image pickup device:** 2/3" 2.2 million-pixel IT, CCD × 3  
**System:** GBR image pickup system  
**Resolving optical system:** F1.4 prism  
**Optical filter:** ND; CLEAR, 1/4, 1/16, 1/64  
**Lens mount:** Bayonet type  
**Output format:** 1080/59.94i  
**Sensitivity:** F10, 2000lx, 3200K, white reflection rate 89.9 %  
**S/N:** 60 dB typ.  
**Ambient operating temperature:**  
+32 °F to +104 °F (0 °C to +40 °C)  
**Storage temperature:** -4 °F to +140 °F (-20 °C to +60 °C)  
**Weight:** Approx. 3.3 lbs. (1.5 kg)  
**Dimensions (W × H × D):** 3-9/16" × 4-5/8" × 6-5/16" (90 × 117 × 160 mm)  
(excluding protrusions)

## Input/output signal

**Video output:** HD SDI (BNC 1 system)  
**SYNC input:** SYNC input (GL input 3 value SYNC/BB)  
**Camera connector:** D-SUB 15-pin connector seat (JAE: D02-M15SAG-20L9E)  
**Control system:** Synchronous (EIA-422)  
**Lens connector 1:** Iris control (HIROSE: HR10A-10R12SC)  
**Lens connector 2:** Zoom, focus control (HIROSE: HR10A-10R12PC)

Weight and dimensions shown are approximate.  
Specifications are subject to change without notice.

# Panasonic®

**PANASONIC BROADCAST & TELEVISION SYSTEMS COMPANY**  
UNIT COMPANY OF PANASONIC CORPORATION OF NORTH AMERICA

**Headquarters:**

3 Panasonic Way 4E-7, Secaucus, NJ 07094 (201) 348-5300

**EASTERN ZONE:**

3 Panasonic Way 4E-7, Secaucus, NJ 07094 (201) 348-7196

**WESTERN ZONE:**

3330 Cahuenga Blvd. West, Los Angeles, CA 90068 (323) 438-3608

**Government office:**

(201) 348-7587

**Broadcast PARTS INFORMATION & ORDERING:**

9:00 a.m. – 5:00 p.m. (PST) (800) 334-4881/24 Hr. Fax (800) 334-4880

Emergency after hour parts orders (800) 334-4881

**TECHNICAL SUPPORT:**

Emergency 24 Hour Service (800) 222-0741

**Panasonic Canada Inc.**

5770 Ambler Drive, Mississauga, Ontario L4W 2T3 (905) 624-5010

**Panasonic de Mexico S.A. de C.V.**

Av angel Urraza Num. 1209 Col. de Valle 03100 Mexico, D.F. (52) 1 951 2127

**Panasonic Puerto Rico Inc.**

San Gabriel Industrial Park, 65th Infantry Ave., Km. 9.5, Carolina, Puerto Rico 00630  
(787) 750-4300

© 2008 Matsushita Electric Industrial Co., Ltd. All rights reserved.