



METROLOGIC INSTRUMENTS, INC.
MS7220 ArgusSCAN® Presentation
Laser Scanner
Installation and User's Guide



LOCATIONS

CORPORATE HEADQUARTERS

North America	Metrologic Instruments, Inc. 90 Coles Road Blackwood, NJ 08012-4683	Customer Service: 1-800-ID-METRO Tel: 856-228-8100 Fax: 856-228-6673 Email: info@metrologic.com Internet: www.metrologic.com
----------------------	---	--

EUROPEAN HEADQUARTERS

Germany, Middle East and Africa	Metrologic Instruments GmbH Dornierstrasse 2 82178 Puchheim b. Munich, Germany	Tel: +49 89 89019 0 Fax: +49 89 89019 200 Email: info@europe.metrologic.com Germany Email: info@de.metrologic.com
Spain	Metrologic Eria Ibérica SL Julián Camarillo 29, D-1 Edificio Diapasón 28037 Madrid	Tel: +34 913 272 400 Fax: +34 913 273 829 Email: info@es.metrologic.com
Italy	Metrologic Instruments Italia srl Via Emilia 70 40064 Ozzano dell'Emilia (BO)	Tel: +39 0 51 6511978 Fax: +39 0 51 6521337 Email: info@it.metrologic.com
France	Metrologic Eria France SA 69 Rue de la Belle Etoile ZI Paris Nord II, BP 50057 95947 – ROISSY CDG CEDEX	Tel: +33 (0) 1 48.63.78.78 Fax: +33 (0) 1 48.63.24.94 Email: info@fr.metrologic.com
United Kingdom	Metrologic Instruments UK Limited 58 Tempus Business Centre Kingsclere Road, Basingstoke Hampshire RG21 6XG	Tel: +44 (0) 1256 365900 Fax: +44 (0) 1256 365955 Email: info@uk.metrologic.com
Russia	Metrologic Russia Bolshaya Novodmitrovskaya 14 RU-125015 Moscow Russia	Tel: +7 095 5093 485 Email: info@ru.metrologic.com

ASIA

Singapore	Metrologic Asia (Pte) Ltd No. 8 Kaki Bukit Place 4 th Floor Singapore 416186	Tel: 65-6842-7155 Fax: 65-6842-7166 Email: info@sg.metrologic.com
China	Metro (Suzhou) Technologies Co., Ltd. 221 Xing Hai Street Suzhou Industrial Park Suzhou, China 215021	Tel: 86-512-62572511 Fax: 86-512-62571517 Email: info@cn.metrologic.com
Japan	Metrologic Japan Co., Ltd. Matsunoya Building, 6 Floor 3-14-8 Higashiueno Taitou-Ku, Tokyo 110-0015 Japan	Tel: 81-03-3839-8511 Fax: 81-03-3839-8519 Email: info@jp.metrologic.com

SOUTH AMERICA

Brazil	Metrologic do Brasil Ltda. Rua da Paz 2059 CEP 04713-002 Chácara Santo Antônio São Paulo, SP, Brasil	Tel: 55-11-5182-8226 Fax: 55-11-5182-8315 Email: info@br.metrologic.com
Outside Brazil	Metrologic South America Rua da Paz 2059 CEP 04713-002 Chácara Santo Antônio São Paulo, SP, Brasil	Tel: 55-11-5182-7273 Fax: 55-11-5182-7198 Email: info@sa.metrologic.com

Copyright

© 2003 by Metrologic Instruments, Inc. All rights reserved. No part of this work may be reproduced, transmitted, or stored in any form or by any means without prior written consent, except by reviewer, who may quote brief passages in a review, or provided for in the Copyright Act of 1976.

Products and brand names mentioned in this document are trademarks of their respective companies.

TABLE OF CONTENTS

Introduction	1
Scanner and Accessories	2
Getting Started	3
Installation	
OCIA Interface	5
Keyboard Wedge Interface	6
Stand-Alone Keyboard Interface	7
USB Interface	8
RS232 or Light Pen Interfaces	9
Auxiliary Scanner	11
Scanner Parts	13
Power Save Modes and The Multi-Function Button	14
Indicators	
Audible	16
Failure Modes	17
Visual	18
Labels	19
Scan Volume	20
Depth of Field by Minimum Bar Code Element Width	21
EAS Deactivation Antenna	23
Maintenance	23
Troubleshooting Guide	24
RS232 Demonstration Program	29
Applications and Protocols	30
Design Specifications	31
Default Settings	33
MS7220 Stands	
Vertical Stand Parts [MLPN 46-46405]	39
Optional Flex Stand Parts [MLPN 46-46404]	39
Vertical Stand Installation	40
Optional Flex Stand Installation	41
Scanner and Cable Terminations	42
Limited Warranty	46
Laser and Product Safety	47
Patents	49
Index	50

INTRODUCTION

ArgusScan® is an aggressive, omnidirectional laser barcode scanner ideal for retail, convenience, liquor, and specialty store applications. Engineered with a large, easy-to-find optimal scan area, *ArgusScan* increases the first pass read rate for maximum productivity.

ArgusScan is equipped with a multitude of standard features including:

- A bright 650 nm laser
- Programmable depth of field
- PowerLink user replaceable cables
- MetroSet®2, MetroSelect® and MetroOPOS® compatible
- Data editing (parsing) capability using Bits n' Pieces®
- A 2 year warranty

SCANNER	INTERFACE
MS7220-13	RS232, IBM 46xx, OCIA, Aux
MS7220-37	RS232, Light Pen, Keyboard Wedge, Stand-Alone Keyboard, USB, Aux

SCANNER and Accessories

BASIC KIT	
Part #	Description
MS7220	ArgusScan Presentation Scanner
00-02407	MetroSelect® Programming Guide**
00-02554	MS7220 User's and Installation Guide**
46-46406	Standard Horizontal Stand
46-46405	Standard Vertical Stand
**Also available for download at www.metrologic.com	

OPTIONAL ACCESSORIES	
Part #	Description
AC to DC Power Transformer - Regulated 5.2V @ 1 A output	
46-46759	120V United States
46-46616	220V – 240V Continental European
46-46615	220V – 240V United Kingdom
46-46984	220V – 240V China
46-46985	220V – 240V Australia
54-54xxx*	Straight PowerLink Cable with built in power jack. 2.1 m (7') cord with short strain relief
53-53xxx*	Coiled PowerLink Cable with built in power jack. 2.7 m (9') cord with long strain relief
* xxx specifies connection to the host	
54-54002	Keyboard Wedge PowerLink Cable w/ Adapter Cable
54-54020	Stand Alone Keyboard Wedge PowerLink Cable
54-54667	RS232 AUX PowerLink Cable
46-46404	Optional Flex Stand

Other items may be ordered for the specific protocol being used. To order additional items, contact the dealer, distributor or call Metrologic's Customer Service Department at 1-800-ID-METRO or 1-800-436-3876.

GETTING STARTED

Tools needed:

- Phillips head screwdriver
- $\frac{1}{4}$ "-20 wrench
- Drill with a #39 drill bit (*drill for hard-mount installation only*)

1 Slide off the cable cover.

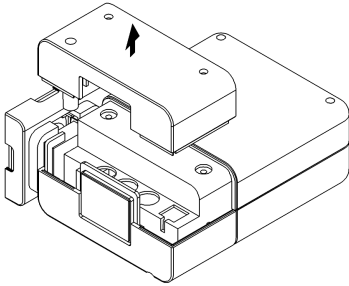

2 Slide off the horizontal stand.

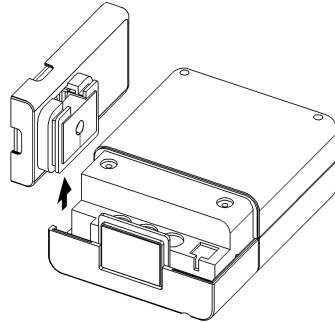

3 Slide on the cable door and remove the foam insert.

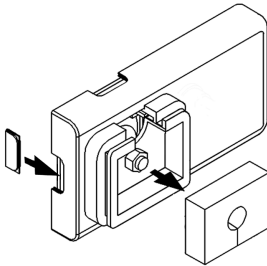

4 Loosen the lock nut, push back the metal base plate and then slide the cable through the cable opening.

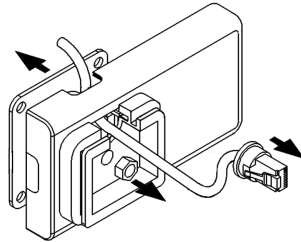

5 Mounting the MS7220: Peel off the base plate's tape backing and affix it to the countertop or drill four #39 pilot holes and secure the base plate to the countertop with the four #8 wood screws provided.

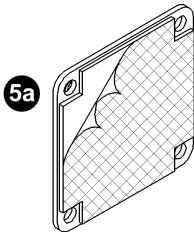

OR

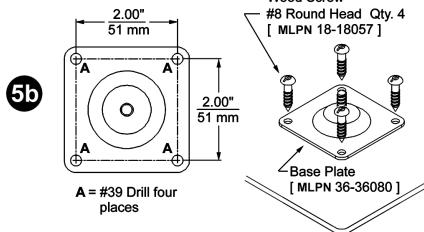

Continued on next page.

GETTING STARTED

- 6** Return the metal base plate to its original position then tighten the lock nut.

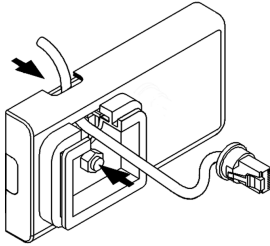

- 7 & 8** Return the foam insert to its original position then slide the horizontal stand back into place on the scanner.

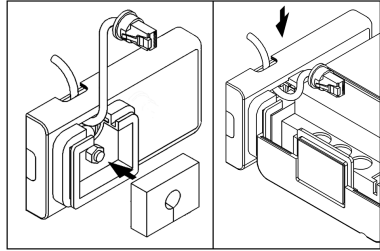

- 9** **STOP** Before continuing, determine what communication interface is needed then follow the installation procedure for that interface on pages 5-12.

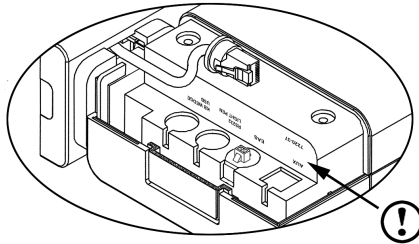

It is important to use the correct communication jack on the back of the scanner (see pages 5-12 for cable the proper connections). Incorrect cable connections can cause communication problems or potential damage to the scanner

- 10** **After the communication cable has been connected properly**, slide the cable cover down then secure in place with the three M3x .5 x 6 mm pan head screws provided.

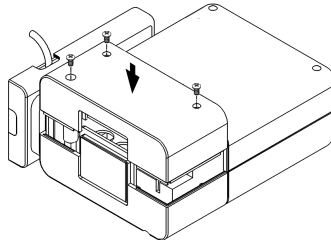

See the "MS7220 Stands" section of this guide for additional information on the vertical [MLPN 46-46405] and flexible [MLPN 46-46406] stand options.

INSTALLATION FOR OCIA INTERFACE

1. Follow the “Getting Started” steps on page 3.
2. Turn off the host system.
3. Connect the MVC cable to the 10-pin OCIA interface jack. It is the 2nd round opening from the left side of the MS7220 (see figure 1).
4. Connect the other end of the MVC cable to the host.



Before continuing verify that the MVC cable is connected to the appropriate interface jack on the scanner. An incorrect cable connection can cause communication problems or potential damage to the scanner.



Plugging the scanner into the serial port of the PC does not guarantee that scanned information will appear at the PC. A software driver and correct configuration settings are also required for proper communication.

5. Slide the cable cover into place on the back of the scanner then secure it with the three M3 screws provided.
6. Turn on the host system.
7. Scan the Load OCIA Defaults bar code to configure the MS7220 for OCIA communication.

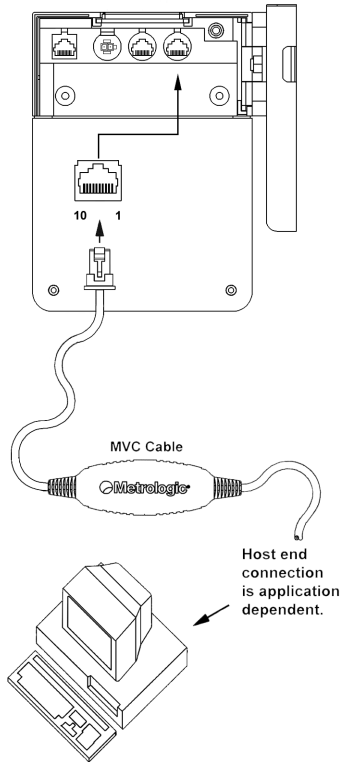

Figure 1: OCIA, Interface



For additional communication options for OCIA interfaces refer to the MetroSelect Programming Guide (MLPN 00-02407).

Caution:

To maintain compliance with applicable standards, all circuits connected to the scanner must meet the requirements for SELV (Safety Extra Low Voltage) according to EN 60950.

To maintain compliance with standard CSA C22.2 No. 60950-00/UL 60950 and norm EN 60950, the power source should meet applicable performance requirements for a limited power source.

INSTALLATION FOR KEYBOARD WEDGE INTERFACE

1. Follow the “Getting Started” steps on page 3.
2. Turn off the host system.
3. Disconnect the keyboard from the host.
4. Connect the PowerLink cable to the 10-pin KBW interface jack. It is the 2nd round opening from the left side of the MS7220 (see figure 2).
5. Connect the “Y” end of the PowerLink cable to the keyboard and the keyboard port on the host. If necessary use the male/female adapter cable supplied with the scanner for proper connections.



Before continuing verify that the PowerLink cable is connected to the appropriate interface jack on the scanner. An incorrect cable connection can cause communication problems or potential damage to the scanner.

6. Connect the external power supply to the power jack on the PowerLink cable.
7. Check the AC input requirements of the power supply to make sure the voltage matches the AC outlet.
8. Connect AC power to the transformer. The outlet should be near the equipment and easily accessible.
9. Slide the cable cover into place on the back of the scanner then secure it with the three M3 screws provided.
10. Turn on the host system.
11. Scan the bar code below to configure the MS7220 for Keyboard Wedge communication.

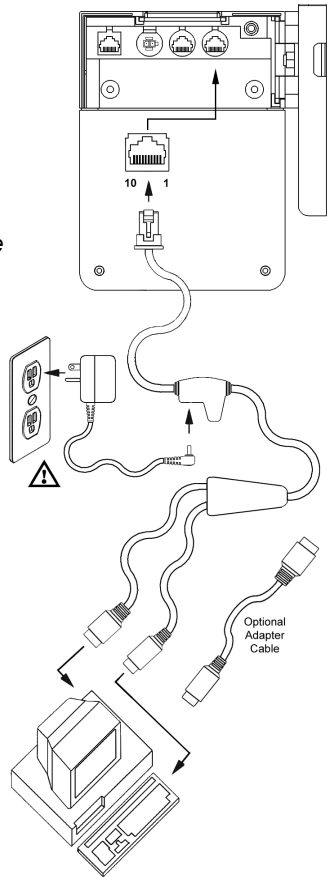

Figure 2: Keyboard Wedge Interface

Load Keyboard
Wedge Defaults



Caution:

To maintain compliance with applicable standards, all circuits connected to the scanner must meet the requirements for SELV (Safety Extra Low Voltage) according to EN 60950.

To maintain compliance with standard CSA C22.2 No. 60950-00/UL 60950 and norm EN 60950, the power source should meet applicable performance requirements for a limited power source.

INSTALLATION FOR STAND-ALONE KEYBOARD INTERFACE

1. Follow the “Getting Started” steps on page 3.
2. Turn off the host system.
3. Disconnect the keyboard from the host.
4. Connect the PowerLink cable to the jack labeled “Stand-Alone Keyboard” on the MS7220.
5. Connect the other end of the PowerLink cable to the keyboard port on the host.



Before continuing verify that the powerlink cable is connected to the proper communication jack on the scanner. Incorrect cable connection can cause communication problems or potential damage to the scanner.

6. Connect the external power supply to the power jack on the PowerLink cable.
7. Check the AC input requirements of the power supply to make sure the voltage matches the AC outlet.
8. Connect AC power to the transformer. The outlet should be near the equipment and easily accessible.
9. Slide the cable cover into place on the back of the scanner then secure it with the three M3 screws provided.
10. Turn on the host system.
11. Scan the two bar codes in order to configure the MS7220 for Stand-Alone Keyboard communication.

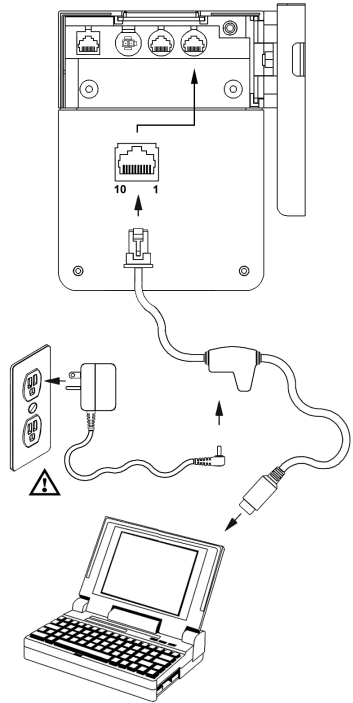

Figure 3: Stand-Alone Keyboard Interface

Load Keyboard Wedge Defaults

Scan 1st



Enable Stand-Alone Keyboard Wedge

Scan 2nd



Note: When scanning the bar codes, cover the code not being scanned to ensure the codes are read in the proper sequence.

⚠ Caution:

To maintain compliance with applicable standards, all circuits connected to the scanner must meet the requirements for SELV (Safety Extra Low Voltage) according to EN 60950.

To maintain compliance with standard CSA C22.2 No. 60950-00/UL 60950 and norm EN 60950, the power source should meet applicable performance requirements for a limited power source.

INSTALLATION FOR USB INTERFACE

1. Follow the “Getting Started” steps on page 3.
2. Turn off the host system.
3. Determine if your application requires USB Keyboard communication protocols or USB Point-of-Sale communication protocols.
4. If you require USB Keyboard communication protocols, skip to step 5.

If you require USB Point-of Sale communication protocols set the dip switches shown in figure 4a to positions 1 and 2.

5. Connect the PowerLink cable to the 10-pin USB interface jack. It is the 2nd round opening from the left side of the MS7220 (see figure 4b).
6. Connect the other end of the USB cable to the host.



Before continuing verify that the USB cable is connected to the appropriate interface jack on the scanner. An incorrect cable connection can cause communication problems or potential damage to the scanner.



Plugging the scanner into the USB port of the PC does not guarantee that scanned information will appear at the PC. A software driver and correct configuration setting are also required for proper communication.

7. Slide the cable cover into place on the back of the scanner then secure it with the three M3 screws provided.
8. Turn on the host system.
9. Scan the Enable USB Defaults bar code to configure the MS7220 for USB communication.

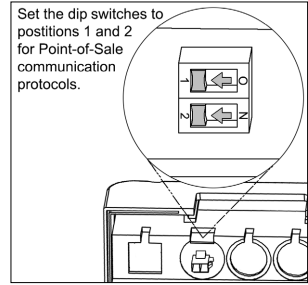

Figure 4a: POS Dip Switch

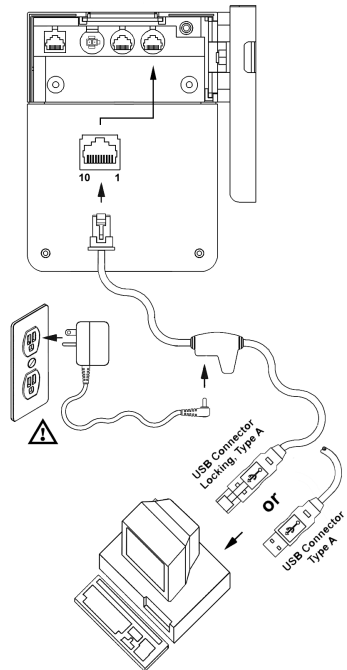

Figure 4b: USB, Interface

Enable USB Defaults



⚠ Caution:

To maintain compliance with applicable standards, all circuits connected to the scanner must meet the requirements for SELV (Safety Extra Low Voltage) according to EN 60950.

To maintain compliance with standard CSA C22.2 No. 60950-00/UL 60950 and norm EN 60950, the power source should meet applicable performance requirements for a limited power source.

INSTALLATION FOR RS232 OR LIGHT PEN INTERFACES

1. Follow the “Getting Started” steps on page 3.
2. Turn off the host system.
3. Connect the PowerLink cable to the 10-pin RS232/Light Pen interface jack. It is the 1st round opening from the left side of the MS7220.
4. Connect the other end of the PowerLink cable to the host.



Before continuing verify that the powerlink cable is connected to the appropriate communication jack on the scanner. An incorrect cable connection can cause communication problems or potential damage to the scanner.

5. Connect the external power supply to the power jack on the PowerLink cable.
6. Check the AC input requirements of the power supply to make sure the voltage matches the AC outlet.
7. Connect AC power to the transformer. The outlet should be near the equipment and easily accessible.
8. Slide the cable cover into place on the back of the scanner then secure it with the three M3 screws provided.
9. Turn on the host system.
10. Scan the appropriate bar codes on page 10 to configure the MS7220 for RS-232 or Light Pen communication.

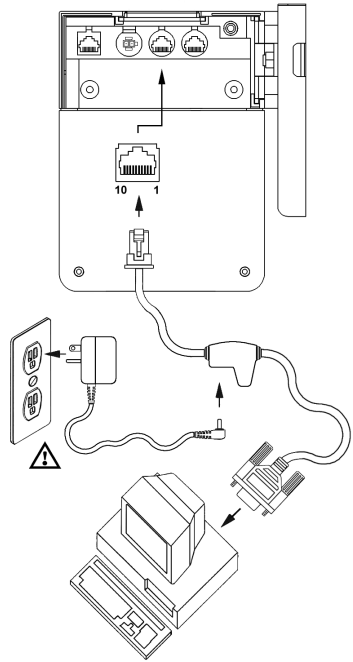

Figure 5: RS232 or Light Pen Interface

⚠ Caution:

To maintain compliance with applicable standards, all circuits connected to the scanner must meet the requirements for SELV (Safety Extra Low Voltage) according to EN 60950.

To maintain compliance with standard CSA C22.2 No. 60950-00/UL 60950 and norm EN 60950, the power source should meet applicable performance requirements for a limited power source.

INSTALLATION FOR RS232 OR LIGHT PEN INTERFACES

Step 10, page 9 continued.

For RS232 Communication:



For Light Pen Communication:



INSTALLATION OF AN AUXILIARY SCANNER

1. Turn off the host system.
2. Connect the round end of the *PowerLink RS232 AUX* cable [MLPN 54-54667A] to the RS232 jack of the auxiliary scanner (see figure 6).
3. Connect the other end of the *PowerLink RS232 AUX* cable into the 1st jack from the left side of the MS7320. The Aux jack has a **square** opening.

The following Metrologic scanners can be used in the “Aux” input of the MS7220: the MS9520, MS9540, MS6220, MS7120, MS6520, MS6720, MS7320 or another MS7220.

 **Important:** The MS7220 aux port requires the signals: transmit, receive, RTS & CTS from the auxiliary scanner.

4. Connect the MS7220/Host PowerLink* cable to the appropriate interface jack on the back of the MS7220.
5. Connect the other end of the MS7220/Host PowerLink cable to the Host.
6. Connect the external power supplies for the auxiliary scanner and the MS7220 to the power jacks on the two PowerLink cables.

 Before continuing verify that the powerlink cable is connected to the appropriate interface jack on the scanner. An incorrect cable connection can cause communication problems or potential damage to the scanner.

7. Check the AC input requirements of both power supplies to make sure the voltage matches the AC outlets.
8. Slide the cable cover into place on the back of the scanner then secure it with the three M3 screws provided.
9. Connect AC power to the transformers. The outlets should be near the equipment and easily accessible.
10. Configure the MS7220 for the appropriate interface configuration settings.*

* The MS7220/host cable connection is interface dependent. Refer to the installation steps provided for the type of interface required for your application.

Continued on page 12.

 **Caution:**

To maintain compliance with applicable standards, all circuits connected to the scanner must meet the requirements for SELV (Safety Extra Low Voltage) according to EN 60950.

To maintain compliance with standard CSA C22.2 No. 60950-00/UL 60950 and norm EN 60950, the power source should meet applicable performance requirements for a limited power source.

INSTALLATION OF AN AUXILIARY SCANNER

11. Configure the **auxiliary scanner** to send formatted data to the MS7220. Normal slave mode operation will only require reserve Code 32 to be set in the auxiliary scanner. The *Reserve Code 32* bar code applies for all scanners, **except the MS6720**, to be used as an auxiliary scanner. Contact a Metrologic representative for information on the MS6720.



12. Configure the MS7220 to activate the auxiliary port. Enable the auxiliary port and configure it to recognize slave formatted data with the following bar code:



13. Turn on the host system.

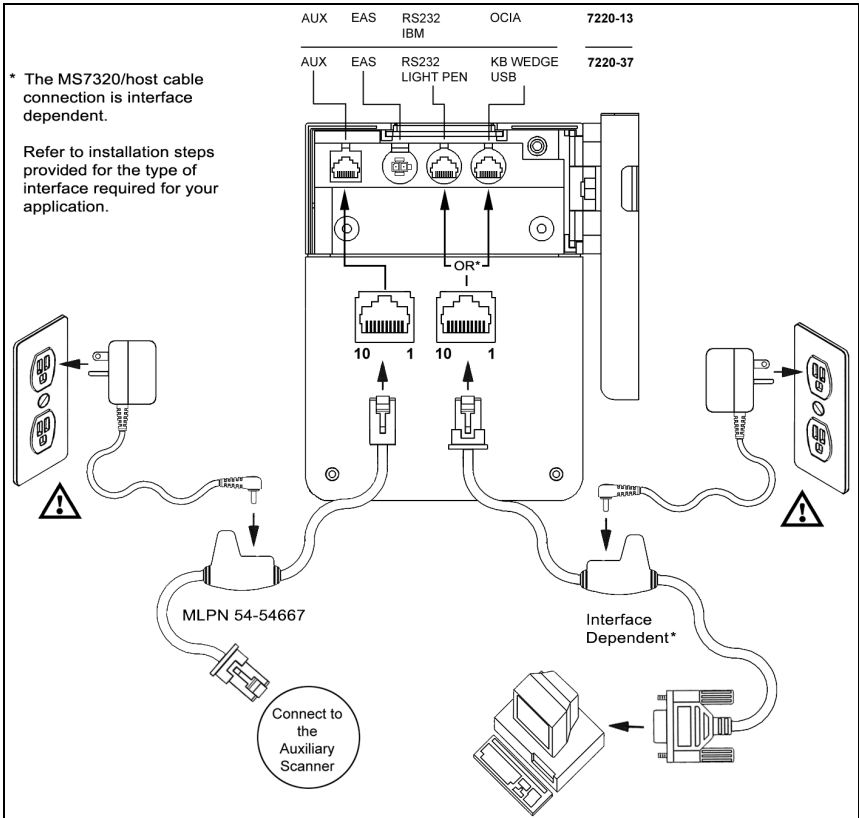

Figure 6: Auxiliary Scanner Setup

SCANNER PARTS

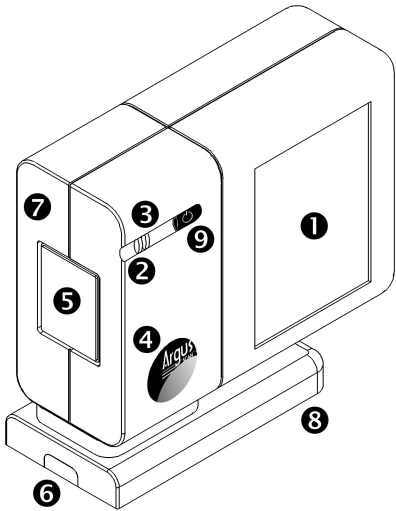

Figure 7a: Scanner Parts

- ❶ Output Window
- ❷ Red LED
- ❸ Green LED
- ❹ Speaker
- ❺ Side Cover
- ❻ Cable Door
- ❼ Cable Jack Cover
- ❽ Horizontal Mount Base
- ❾ Multi-Function Button
(see page 15)
- ❿ Cable Connection Area
- ⓫ Foam Insert

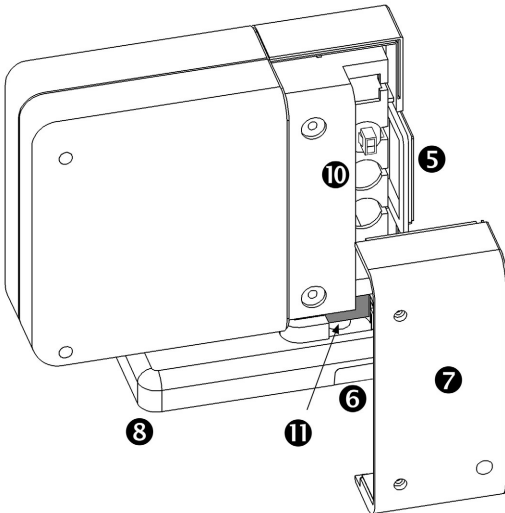

Figure 7b: Scanner Parts

POWER SAVE MODES AND THE MULTI-FUNCTION BUTTON

The MS7220 has five programmable power save modes. Refer to the *MetroSelect Programming Guide* for additional information on Power Save Modes.

1. **Blink Power Save Mode (Default):**

“Blinks” the laser OFF & ON after a programmed period of non-use.

When the scanner recognizes a bar code it will exit the Blink mode.

2. **Laser Off Power Save Mode:**

Turns the laser OFF after a programmed period of non-use.

The motor continues to spin allowing for a faster “wake” up time. Pressing the Multi-Function button will “wake” the scanner from the *Laser Off* power save mode (see figure 8d).

3. **Laser & Motor Off Power Save Mode:**

Turns the laser and motor OFF after a programmed period of non-use.

Pressing the Multi-Function button will “wake” the scanner from the power save mode (see figure 8d). This mode is the only power save mode that can be activated by the Multi-Function Button (see figure 8c). This mode’s “wake up” time is slightly longer due to the motor’s need to restart.

4. **Dual Action Power Save Mode #1:**

“Blinks” the laser OFF & ON after a programmed period of non-use turns the laser and motor OFF at thirty-minute intervals.

Example:

If the power save timeout is set to 15 minutes.

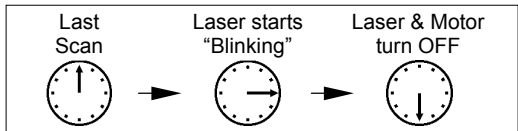

Pressing the Multi-Function button will “wake” the scanner from the power save mode (see figure 8d).

5. **Dual Action Power Save Mode #2:**

Turns the laser OFF after a programmed period of non-use then turns the motor OFF after thirty-minute intervals.

Example:

If the power save timeout is set to 15 minutes.

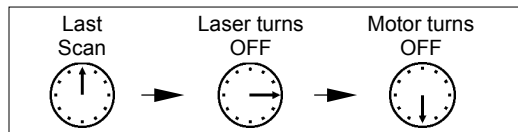

Pressing the Multi-Function button will “wake” the scanner from the power save mode (see figure 8d).

POWER SAVE MODES AND THE MULTI-FUNCTION BUTTON

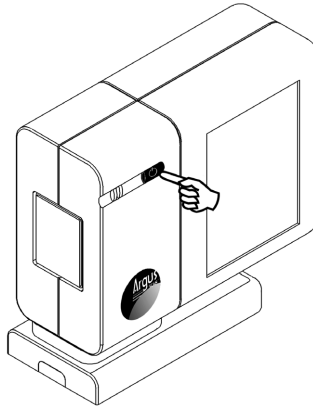

Figure 8a: Multi-Function Button

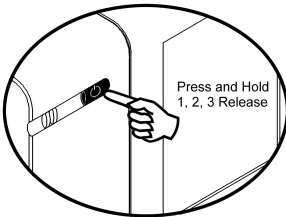

Figure 8b: Changing the Beeper Tone

CHANGING THE BEEPER TONE

A short (<3 second) depression and the beeper tone will change. The new tone will be heard, followed by a short pause. Then two more of the new tones will be heard signifying the new setting has been stored in memory. The silent (no beep) tone is also selectable.

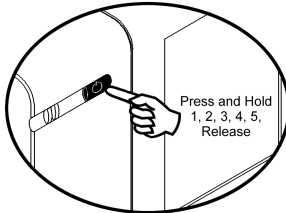

Figure 8c: Laser & Motor Power Save mode

PLACING THE UNIT IN LASER & MOTOR OFF POWER SAVE MODE

Long (>3 seconds) depression
The *Laser & Motor Off Power Save Mode* is the only power save mode that can be activated with the multi-function button.

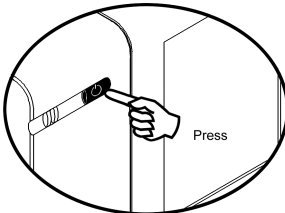

Figure 8d: Normal Operation

WAKING THE UNIT FROM ALL POWER SAVE MODES

The next button depression will awaken the scanner for normal operation.

AUDIBLE INDICATORS

When the MS7220 scanner is in operation, it provides audible feedback. These sounds indicate the status of the scanner. Eight settings are available for the tone of the beep (normal, 6 alternate tones and no tone). To change the tone, use the *Multi-Function Button* or refer to the MetroSelect Programming Guide (MLPN 00-02407).



One Beep

When the scanner *first* receives power, the green LED will turn on, the red LED will flash and the scanner will beep once. The red LED will remain on for the duration of the beep. The scanner is now ready to scan.

When the scanner *successfully* reads a bar code, the red LED will flash and the scanner beeps once (if programmed to do so). If the scanner does not beep once and the red light does not flash, then the bar code has *not* been successfully read.



Razzberry Tone

This is a failure indicator. Refer to failure modes page 17.

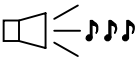

Three Beeps - during operation

When placing the scanner in program mode, the red LED will flash while the scanner simultaneously beeps three times. The red and green LEDs will continue to flash until the unit exits program mode. Upon exiting program mode, the scanner will beep three times and the red LED will stop flashing.

When configured, 3 beeps can also indicate a communications timeout during normal scanning mode.

When using one-code-programming, the scanner will beep three times (the current selected tone), followed by a short pause, a high tone and a low tone. This tells the user that the single configuration bar code has *successfully* configured the scanner.

Three beeps will also occur during a manual adjustment of the beeper tone. With each short depression of the *Multi-Function Button*, the new tone will be heard, followed by a short pause then two more of the new current tones.

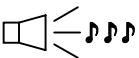

Three Beeps - on power up

This is a failure indicator. Refer to failure modes page 17.

FAILURE MODES

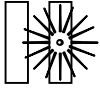

Flashing Green and One Razzberry Tone

This indicates the scanner has experienced a laser subsystem failure. Return the unit for repair at an authorized service center.

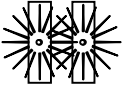

Flashing Red and Green and Two Razzberry Tones

This indicates the scanner has experienced a motor failure. Return the unit for repair at an authorized service center.

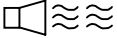

Continuous Razzberry Tone with both LEDs off

If, upon power up, the scanner emits a continuous razzberry tone, then the scanner has an electronic failure. Return the unit for repair at an authorized service center.

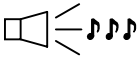

Three Beeps - on power up

If the scanner beeps 3 times on power up then, the nonvolatile memory that holds the scanner configuration has failed. Return the unit for repair at an authorized service center.

VISUAL INDICATORS

There is a red LED and a green LED on the front of the MS7220. When the scanner is on, the flashing or constant illumination of the LEDs indicates the status of the current scan and the scanner.



No Red or Green LED

The LEDs will not be illuminated if the scanner is not receiving power from the host or transformer.



Steady Green

When the laser is active, the green LED is illuminated. The green LED will remain illuminated until the laser is deactivated.

During the power save mode, the laser will turn on and off. During this period, the green LED remains illuminated.



Steady Green and Single Red Flash

When the scanner successfully reads a bar code, the red LED will flash and the scanner will beep once. If the red LED does not flash or the scanner does not beep once, then the bar code has not been successfully read.



Steady Green and Steady Red

After a successful scan, the scanner transmits the data to the host device. Some communication modes require that the host inform the scanner when data is ready to be received. If the host is not ready to accept the information, the scanner's red LED will remain on until the data can be transmitted.



Flashing Green then Flashing Red

This indicates the scanner is in program mode. A razzberry tone indicates that an invalid bar code has been scanned in this mode.

or



If the unit is in sleep mode, each LED will flash once every 15 seconds.



Steady Red, Green off

This indicates the scanner may be waiting for communication from the host.

LABELS

Each scanner has a label on the back of the unit. The label contains information such as the model number, date of manufacture, and the serial number. Additional CE and caution information has been molded into the back of the case. The following is an example of the back of the case with the label and molded text.

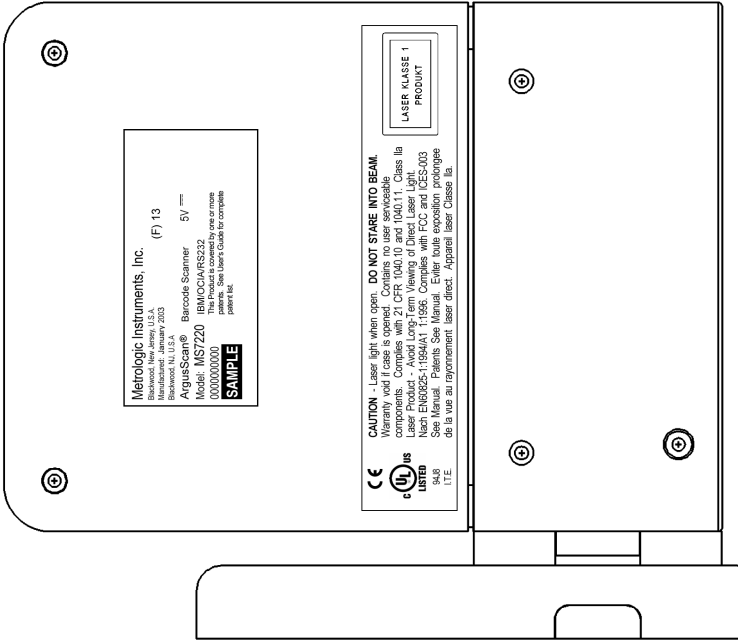
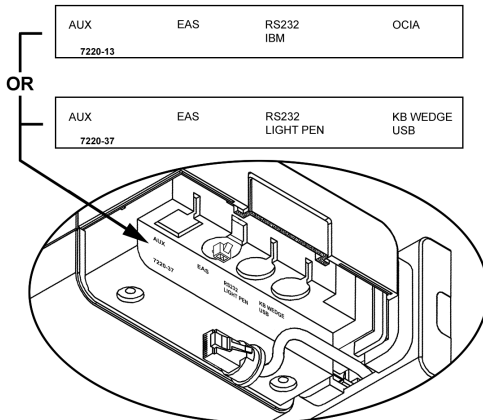

Figure 9: Back view of the case. (Top)
Interface Label, Located Under the Cable Jack Cover (Bottom)



SCAN VOLUME (DEFAULT)

(BASED ON 100% UPC BAR CODES)

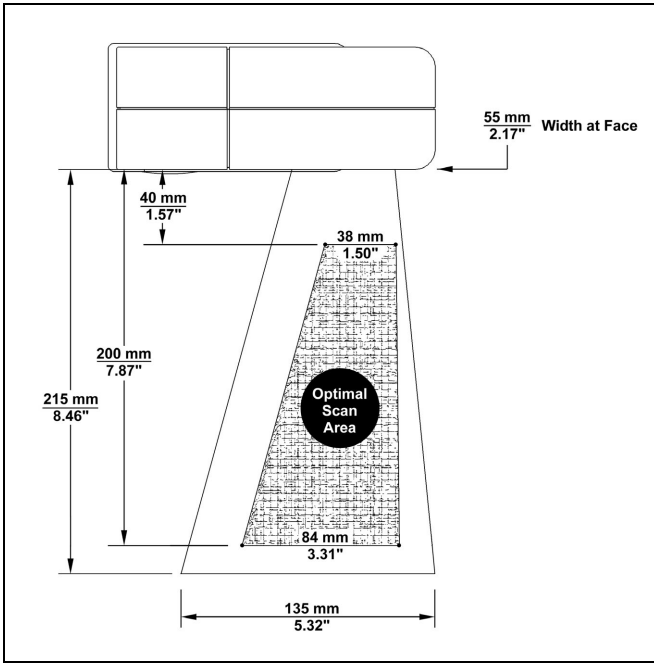

Figure 10: Top View Scan Volume (Default)

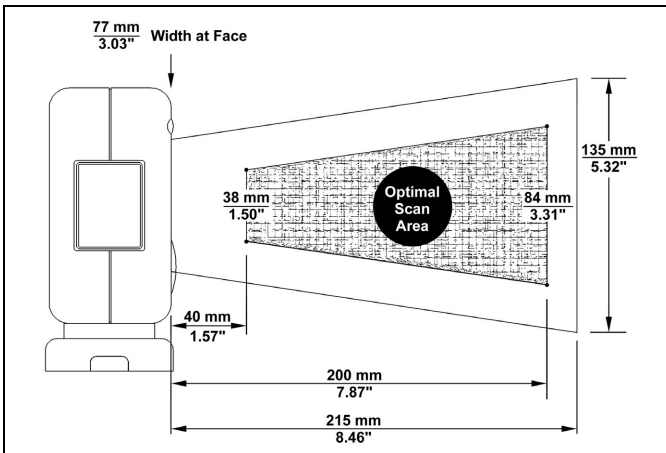

Figure 11: Side View Scan Volume (Default)

Specifications subject to change without notice.

DEPTH OF FIELD BY MINIMUM BAR CODE ELEMENT WIDTH

(BASED ON 100% UPC BAR CODES)

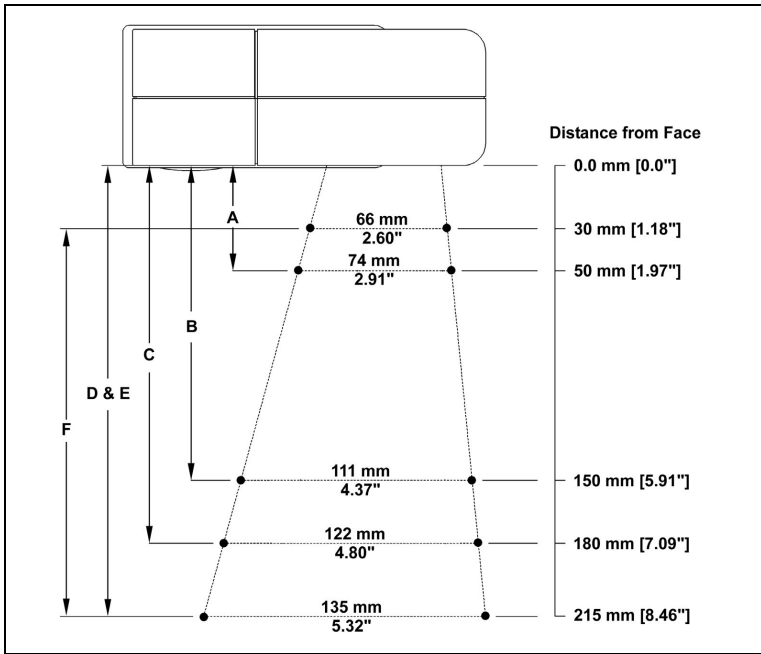

Figure 12: Top View of Default Depth of Field

Minimum Bar Code Element Width						
	A	B	C	D	E	F
mm	.13	.19	.26	.33	.48	.66
mils	5.2	7.5	10.4	13	19	26

Specifications subject to change without notice.

DEPTH OF FIELD BY MINIMUM BAR CODE ELEMENT WIDTH

(BASED ON 100% UPC BAR CODES)

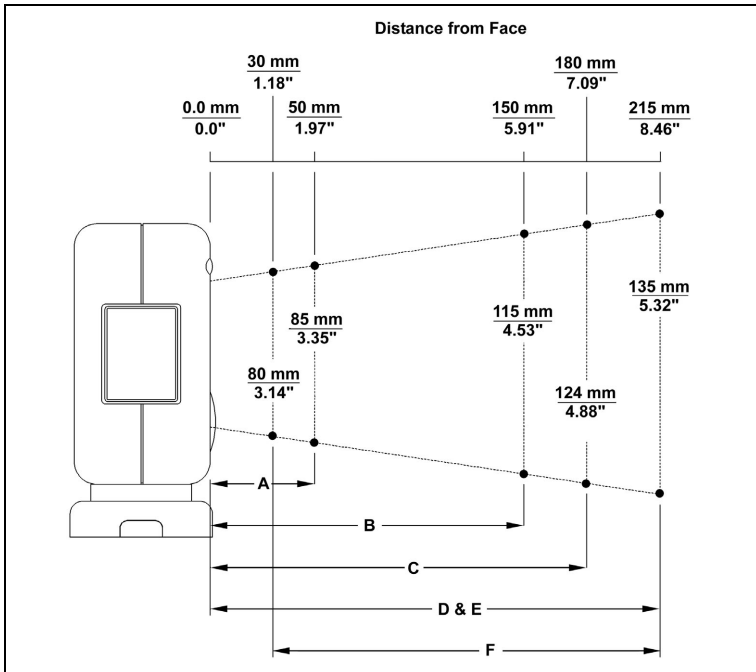

Figure 13: Side View of Default Depth of Field

Minimum Bar Code Element Width						
	A	B	C	D	E	F
mm	.13	.19	.26	.33	.48	.66
mils	5.2	7.5	10.4	13	19	26

Specifications subject to change without notice.

EAS DEACTIVATION ANTENNA

SW1 and SW2 are the switch banks inside the CheckPoint Device that set the deactivation range. Metrologic recommends end users program the MS7220 to the Fixed Low-Density depth of field, so that the unit does not scan out beyond the deactivation range.

Unit #	CheckPoint Recommended Switch Bank Settings	MS7220 Depth of Field Settings
MS7320	SW1 & SW2 switches 2, 3, 4, 5, and 6 set to ON	Default
<i>*Note: Minimum element width changes to 6.8 mil when in this mode.</i>		

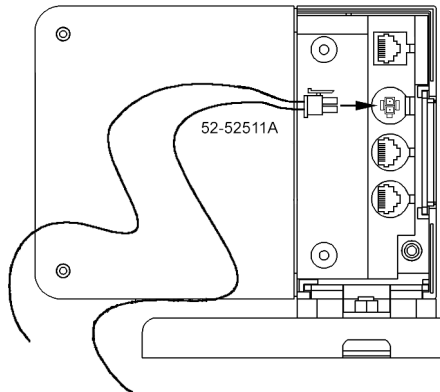

Figure 14: EAS Deactivation Antenna

Contact Checkpoint Systems directly for additional EAS support.

MAINTENANCE

Smudges and dirt can interfere with the proper scanning of a bar code. Therefore, the output window will need occasional cleaning.

1. Spray glass cleaner onto lint free, non-abrasive cleaning cloth.
2. Gently wipe the scanner window.

TROUBLESHOOTING GUIDE

The following guide is for reference purposes only. Contact a Metrologic representative at 1-800-ID-METRO or 1-800-436-3876 to preserve the limited warranty terms.

MS7220 Series Troubleshooting Guide		
SYMPTOMS	POSSIBLE CAUSE(S)	SOLUTION
<i>All Interfaces</i>		
No LEDs, No beep or No motor spin	No power is being supplied to the scanner.	Check the transformer, outlet and power strip. Make sure the cable is plugged into the scanner.
No LEDs, No beep	No power is being supplied to the scanner from host.	Some host systems cannot supply enough current to power an <i>ArgusScan</i> . Use the power supply included with the scanner.
The unit beeps 3 times on power up.	There has been a Non-volatile RAM failure.	Contact a Metrologic service representative, if the unit will not hold the programmed configuration.
The unit razzes continuously on power up.	There is a RAM or ROM failure.	Contact a Metrologic service representative if the unit will not function.
At power up, there is a Razz tone and the green LED flashes.	There has been a VLD failure.	Contact a Metrologic service representative.
At power up, there is a Razz tone and both LEDs flash.	There has been a scanner motor failure.	Contact a Metrologic service representative.
There are multiple scans upon presentation of a bar code.	The same symbol timeout is set too short.	Adjust the same symbol timeout for a longer time.
The unit powers up, but does not beep.	The beeper is disabled. No volume is selected. No tone is selected.	Enable the beeper. Select a volume (programmable). Select a tone.

TROUBLESHOOTING GUIDE (CONTINUED)

SYMPTOMS	POSSIBLE CAUSE(S)	SOLUTION
<p>The unit powers up, but does not scan and/or beep.</p>	<p>The unit is scanning a particular symbology that is not enabled.</p>	<p>UPC/EAN, Code 39, interleaved 2 of 5, Code 93, Code 128 and Codabar are enabled by default. Verify that the type of bar code being read has been enabled.</p>
	<p>The scanner has been programmed for a character length lock, or a minimum length and the bar code being scanned does not satisfy the programmed criteria.</p>	<p>Verify that the bar code being scanned falls into the programmed criteria. (Typical of Non-UPC/EAN codes. <i>The scanner defaults to a minimum of 4 character bar code.</i>)</p>
<p>The unit scans a bar code, but locks up after the first scan (the red LED stays on).</p>	<p>The scanner is configured to support some form of host handshaking but is not receiving the signal.</p>	<p>If the scanner is setup to support ACK/NAK, RTS/CTS, XON/XOFF or D/E, verify that the host cable and host are supporting the handshaking properly.</p>
<p>The unit scans, but the data transmitted to the host is incorrect.</p>	<p>The scanner's data format does not match the host system requirements.</p>	<p>Verify that the scanner's data format matches the host systems requirements. Make sure that the scanner is connected to the proper host port.</p>
<p>The unit beeps for some bar codes and NOT for others of the same bar code symbology.</p>	<p>The print quality of the bar code is suspect.</p>	<p>Check the print mode. The type of printer could be the problem. Change print settings. For example change the print mode to econo or high speed.</p>
	<p>Check the character length lock.</p>	
	<p>The aspect ratio of the bar code is out of tolerance.</p>	

TROUBLESHOOTING GUIDE (CONTINUED)

SYMPTOMS	POSSIBLE CAUSE(S)	SOLUTION
The unit beeps for some bar codes and NOT for others of the same bar code symbology	The bar code may have been printed incorrectly.	Check if it is a check digit/character/or border problem.
	The scanner is not configured correctly for the type of bar code.	Check if the check digits are set properly.
	The minimum symbol length setting does not work with the bar code.	Check if the correct minimum symbol length is set.
Keyboard Wedge Only		
The unit scans the bar code but there is no data.	The configuration is not correct.	Make sure the scanner is configured for the appropriate mode.
The unit scans but the data is not correct.	The configuration is not correct.	Make sure that the proper PC type (AT, PS2 or XT) is selected. Verify the correct country code and data formats are selected. Adjust the intercharacter delay.
The unit is transmitting each character	The configuration is not correct.	Increase the interscan code delay setting. Adjust whether the F0 break is transmitted. It may be necessary to try this in both settings.

TROUBLESHOOTING GUIDE (CONTINUED)

SYMPTOMS	POSSIBLE CAUSE(S)	SOLUTION
Alpha characters show as lower case.	The computer is in Caps Lock mode.	Enable <i>Caps Lock Detect</i> setting of the scanner to detect whether the PC is operating in Caps Lock.
Everything works except for a couple of characters.	The characters may not be supported by that country's key look up table.	Try operating the scanner in the Alt mode.
RS-232 Only		
The unit is transmitting each character.	The configuration is not set correctly.	Increase the interscan code delay setting. Adjust if the F0 break is transmitted. It may be necessary to try this in both settings.
Alpha characters show as lower case.	The computer is in Caps Lock mode.	Enable the <i>Caps Lock detect</i> setting of the scanner to detect whether the PC is operating in Caps Lock.
Power-up OK and scans OK but does not communicate properly to the host	Com port at the host is not working or configured properly	Check to make sure that the baud rate and parity of the scanner and the communication port match and the program is looking for "RS-232" data
	Com port not operating properly.	
	Cable not connected to the proper com port	
The host is receiving data but the data does not look correct.	The scanner and host may not be configured for the same interface font.	Check that the scanner and the host are configured for the same interface font.

TROUBLESHOOTING GUIDE (CONTINUED)

SYMPTOMS	POSSIBLE CAUSE(S)	SOLUTION
Characters are being dropped.	Intercharacter delay needs to be added to the transmitted output.	Add some intercharacter delay to the transmitted output by using the MetroSelect Programming Guide (MLPN 00-02407).
Slave operation with any interface		
Trouble with the Slave Scanner.		Refer to the user's guide provided with the slave scanner.
Slave Scanner powers up but data is not relayed to the host.	Cable [MLPN 54-54667] may not be connected to the proper port.	Ensure slave scanner is connected to the MS7220 com port marked "Aux" port.
	The "Aux" com port may not be operating properly.	<p>* The MS7220 must be programmed to enable the "Aux" port.</p> <p>The slave scanner must be configured to send "slave" formatted data (reserve code 32).</p>
<p>* Use MetroSet®. For the Auxiliary interface, choose "HoloTrak Decode". All remaining parameters will be automatically chosen.</p>		
USB Only		
The unit powers and scans but does not communicate.	The USB Port is not operating correctly.	Check that the scanner is programmed for USB operation.
		Check that the host's USB port is enabled.
The unit emits a razz tone and the LEDs flash three times when configured for USB.	The USB port is not operating correctly.	Disconnect then reconnect the USB cable at the host end. Contact a Metrologic service representative if symptoms persist.

RS232 DEMONSTRATION PROGRAM

If an RS232 scanner is not communicating with your IBM compatible PC, key in the following BASIC program to test that the communication port and scanner are working. This program is for demonstration purposes only. It is only intended to prove that cabling is correct, the com port is working, and the scanner is working. If the bar code data displays on the screen while using this program, it only demonstrates that the hardware interface and scanner are working. At this point, investigate whether the application software and the scanner configuration match. If the application does not support RS-232 scanners, a software wedge program that will take RS-232 data and place it into a keyboard buffer may be needed. This program tells the PC to ignore RTS-CTS, Data Set Ready (DSR) and Data Carrier Detect (DCD) signals. If the demonstration program works and yours still does not, jumper RTS to CTS and Data Terminal Reading (DTR) to DCD and DSR on the back of your PC.

```
110 CLS
110 ON ERROR GOTO 100
110 OPEN "COM1:9600,S,7,1,CS0,DS0,CD0,LF" AS #1
110 PRINT "SCAN A FEW BAR CODES"
110 LINE INPUT #1, BARCODE$
110 PRINT BARCODE$
110 K$ = INKEY$: IF K$ = CHR$(27) THEN GOTO 32766
110 GOTO 40
110 PRINT "ERROR NO. "; ERR; " PRESS ANY KEY TO TERMINATE."
110 K$ = INKEY$: IF K$ = "" THEN GOTO 110
32766 CLOSE: SYSTEM
32767 END
```

APPLICATIONS AND PROTOCOLS

The model number on each scanner includes the scanner number and factory default communications protocol.

Scanner	Version Identifier	Communication Protocol(s)
7220	13	RS232, IBM 46xx, OCIA, Aux
7220	37	RS232, Light Pen, Keyboard Wedge, Stand-Alone Keyboard, USB, Aux

The MS7220 with Built-in PC Keyboard Wedge Interface is designed to be used for keyboard emulation only. Many RS-232 programmable functions available in other Metrologic scanners are also available as keyboard wedge functions.

The following are the most important selectable options specific to the keyboard wedge.

Keyboard Type

- ** AT (includes IBM® PS2 models 50, 55, 60, 80)
- XT
- IBM PS2 (includes models 30, 70, 8556)

Keyboard Country Type

- ** USA
- French
- Italian
- Belgium
- Japanese
- United Kingdom
- German
- Spanish
- Swiss

** Refer to pages 33-38 for complete information on the factory default settings. Refer to the MetroSelect® Programming Guide (MLPN 00-02407) or MetroSet® 2's help files for information on how to change the default settings.

DESIGN SPECIFICATIONS

MS7220 DESIGN SPECIFICATIONS	
OPERATIONAL	
Light Source:	VLD 650 ± 10 nm
Laser Power:	0.678 mW maximum
Depth of Field:	0 mm to 215 mm 8.5" at default (programmable)
Scan Speed:	2000 scans/second
Scan Pattern:	5 fields of 4 parallel lines (omnidirectional)
Scan Lines:	20
Min Bar Width:	0.13 mm (5.2 mil)
Decode Capability:	Autodiscriminates all standard bar codes; for other symbologies call Metrologic
System Interfaces:	PC Keyboard Wedge, RS-232, OCIA, Light Pen, Stand Alone PC Keyboard
Print Contrast:	35% minimum reflectance difference
No. Characters Read:	up to 80 data characters(Maximum number will vary based on symbology and density)
Roll, Pitch, Yaw:	360°, 60°, 60°
Beeper Operation:	7 tones or no beep
Indicators (LED):	green = laser on, ready to scan red = good read, decoding
MECHANICAL	
Height:	123 mm (4.8")
Depth:	65mm (2.6")
Width:	168 mm (6.6")
Weight:	0.91 Kg (2 lbs)
Termination:	Four 10-pin modular RJ45 Jacks
Cable:	Standard 2.1m (7') straight; optional 2.7m (9') coiled; for other cables call Metrologic

Specifications subject to change without notice

DESIGN SPECIFICATIONS

MS720 DESIGN SPECIFICATIONS	
ELECTRICAL	
Input Voltage:	5.2VDC \pm 0.25V
Power:	1.9 W
Operating Current:	360 mA
DC Transformers:	Class II; 5.2 V @ 1A
Laser Class 1:	CDRH: Class IIa; EN 60825-1: 1994/A11:1996 IEC 60825-1:1993+A1:1997+A2:2001
EMC:	FCC, ICES-003 & EN 55022 Class B
ENVIRONMENTAL	
Operating Temperature:	0°C to 40°C (32°F to 104°F)
Storage Temperature:	-40°C to 60°C (-40°F to 140°F)
Humidity:	5% to 95% relative humidity, non-condensing
Light Levels:	4842 LUX (450 foot candles)
Contaminants:	Sealed to resist airborne particulate contaminants
Ventilation:	None required

Specifications subject to change without notice.

DEFAULT SETTINGS

Many functions of the scanner can be "programmed" - that is, enabled or disabled. The scanner is shipped from the factory programmed to a set of default conditions. The default parameter of the scanner has an asterisk (*) in the charts on the following pages. If an asterisk is not in the default column then the default setting is Off or Disabled. Every communication does not support every parameter. If the communication supports a parameter listed in the charts on the following pages, a check mark will appear.

PARAMETER	DEFAULT	OCIA	RS-232	LIGHT PEN	IBM 46XX	KBW	USB
UPC/EAN	*	✓	✓	✓	✓	✓	✓
Code 128	*	✓	✓	✓	✓	✓	✓
Code 93	*	✓	✓	✓	✓	✓	✓
Codabar	*	✓	✓	✓	✓	✓	✓
Interleaved 2 of 5 (ITF)	*	✓	✓	✓	✓	✓	✓
MOD 10 Check on ITF		✓	✓	✓	✓	✓	✓
Code 11		✓	✓	✓	✓	✓	✓
Code 39	*	✓	✓	✓	✓	✓	✓
Full ASCII Code 39		✓	✓	✓	✓	✓	✓
MOD 43 Check on Code 39		✓	✓	✓	✓	✓	✓
MSI-Plessey		✓	✓	✓	✓	✓	✓
Airline (15 Digit) 2 of 5		✓	✓	✓	✓	✓	✓
Airline (13 Digit) 2 of 5		✓	✓	✓	✓	✓	✓
Matrix 2 of 5		✓	✓	✓	✓	✓	✓
Telepen		✓	✓	✓	✓	✓	✓
UK Plessey		✓	✓	✓	✓	✓	✓
STD 2 of 5		✓	✓	✓	✓	✓	✓
MSI-Plessey 10/10 Check Digit		✓	✓	✓	✓	✓	✓
MSI-Plessey MOD 10 Check Digit	*	✓	✓	✓	✓	✓	✓
Paraf Support		✓	✓	✓	✓	✓	✓
ITF Symbol Lengths	Variable	✓	✓	✓	✓	✓	✓
Minimum Symbol Length	4	✓	✓	✓	✓	✓	✓
Symbol Length Lock	None	✓	✓	✓	✓	✓	✓
Bars High as Code 39	*			✓			

DEFAULT SETTINGS (CONTINUED)

Parameter	Default	OCIA	RS-232	Light Pen	IBM 46XX	KBW	USB
Spaces High as Code 39				✓			
Bars High as Scanned				✓			
Spaces High as Scanned				✓			
DTS/SIEMENS		✓					
DTS/NIXDORF	*	✓					
NCR F		✓					
NCR S		✓					
Poll Light Pen Source				✓			
Beeper Tone	Normal	✓	✓	✓	✓	✓	✓
Beep/Transmit Sequence	Before Transmit	✓	✓	✓	✓	✓	✓
Beeper Volume	Loudest	✓	✓	✓	✓	✓	✓
Communication Timeout	None	✓	✓	✓	✓	✓	✓
Razzberry Tone on Timeout		✓	✓	✓	✓	✓	✓
Three Beeps on Timeout		✓	✓	✓	✓	✓	✓
No Beeps on Timeout	*	✓	✓	✓	✓	✓	✓
Enter Power Save Mode	10 mins.	✓	✓	✓	✓	✓	✓
Blink Power Save Mode	*	✓	✓	✓	✓	✓	✓
Laser OFF Power Save Mode		✓	✓	✓	✓	✓	✓
Laser & Motor OFF Power Save Mode		✓	✓	✓	✓	✓	✓
Dual Action Power Save Mode #1		✓	✓	✓	✓	✓	✓
Dual Action Power Save Mode #2		✓	✓	✓	✓	✓	✓
Same Symbol Rescan Timeout: 200 msec		✓	✓	✓	✓	✓	✓
Same Symbol Rescan Timeout: 500 msec Programmable in 50 msec steps (MAX 6.35 seconds)	*	✓	✓	✓	✓	✓	✓
Same Symbol Rescan Timeout: 1250 msec		✓	✓	✓	✓	✓	✓

DEFAULT SETTINGS (CONTINUED)

Parameter	Default	OCIA	RS-232	Light Pen	IBM 46XX	KBW	USB
Same Symbol Rescan Timeout: 2000 msec		✓	✓	✓	✓	✓	✓
Intercharacter Delay Programmable in 1 msec steps (MAX 255 msec)	1 msec 10 msec in KBW	✓	✓		✓	✓	
Number of Scan Buffers	1	✓	✓	✓	✓	✓	✓
Transmit EAN-8 Check Digit	*	✓	✓		✓	✓	✓
Transmit EAN-13 Check Digit	*	✓	✓		✓	✓	✓
Transmit UPC-A Check Digit	*	✓	✓		✓	✓	✓
Transmit UPC-E Check Digit			✓		✓	✓	✓
Expand UPC-E		✓	✓		✓	✓	✓
Convert UPC-A to EAN-13		✓	✓		✓	✓	✓
UPC GTIN-14 Format		✓	✓		✓	✓	✓
Transmit Lead Zero on UPC-E		✓	✓	✓	✓	✓	✓
Convert EAN-8 to EAN-13		✓	✓		✓	✓	✓
Transmit UPC-A Number System	*	✓	✓	✓	✓	✓	✓
Transmit UPC-A Manufacturer ID#	*	✓	✓	✓	✓	✓	✓
Transmit UPC-A Item ID#	*	✓	✓	✓	✓	✓	✓
Transmit Codabar Start/Stop Characters		✓	✓		✓	✓	✓
CLSI Editing (Enable)		✓	✓		✓	✓	✓
Transmit Mod 43 Check Digit on Code 39		✓	✓		✓	✓	✓
Transmit Code 39 Stop/Start Characters		✓	✓		✓	✓	✓
Transmit Mod 10/ITF		✓	✓		✓	✓	✓
Transmit MSI-Plessey Check Characters		✓	✓		✓	✓	✓
Parity	Space		✓				
Baud Rate	9600		✓				

DEFAULT SETTINGS (CONTINUED)

Parameter	Default	OCIA	RS-232	Light Pen	IBM 46XX	KBW	USB
8 Data Bits			✓				
7 Data Bits	*		✓				
Transmit Sanyo ID Characters			✓			✓	✓
Nixdorf ID			✓			✓	✓
LRC Enabled			✓			✓	✓
UPC Prefix			✓			✓	✓
UPC Suffix			✓			✓	✓
Transmit AIM ID Characters			✓			✓	✓
STX Prefix			✓			✓	✓
ETX Suffix			✓			✓	✓
Carriage Return	*		✓			✓	✓
Line Feed - disabled by default in KBW	*		✓			✓	✓
Tab Prefix			✓			✓	✓
Tab Suffix			✓			✓	✓
"DE" Disable Command			✓				✓
"FL" Laser Enable Command			✓				✓
DTR Handshaking Support			✓				
RTS/CTS Handshaking			✓				
Character RTS/CTS	*		✓				
Message RTS/CTS			✓				
XON/XOFF Handshaking			✓				
ACK/NAK			✓				
Two Digit Supplements		✓	✓	as code 39	✓	✓	✓
Five Digit Supplements		✓	✓	as code 39	✓	✓	✓
Bookland 978		✓	✓	as code 39	✓	✓	✓

DEFAULT SETTINGS (CONTINUED)

Parameter	Default	OCIA	RS-232	Light Pen	IBM 46XX	KBW	USB
Bookland 977 (2 digit) Supplemental Requirement		✓	✓	✓	✓	✓	✓
Supplements are not Required	*	✓	✓	✓	✓	✓	✓
Two Digit Redundancy	*	✓	✓	✓	✓	✓	✓
Five Digit Redundancy		✓	✓	✓	✓	✓	✓
100 msec to Find Supplement Programmable in 100 msec steps (MAX 800 msec)	*	✓	✓	✓	✓	✓	✓
Coupon Code 128		✓	✓	as code 39	✓	✓	✓
Programmable Code Lengths	7 avail.	✓	✓	✓	✓	✓	✓
Programmable Prefix Characters	10 avail.		✓			✓	✓
Suffix Characters			✓			✓	✓
Prefixes for individual Code Types			✓			✓	✓
Editing		✓	✓	✓	✓	✓	✓
Inter Scan-Code Delay Programmable (100 µsec steps)	800 µsec					✓	✓
Function/Control Key Support						✓	✓
Minimum Element Width Programmable in 5.6 µsec steps	1 msec			✓			
Depth of Field							
Variable Depth of Field	*	✓	✓	✓	✓	✓	✓
Normal Depth of Field	*	✓	✓	✓	✓	✓	✓
Extended Depth of Field		✓	✓	✓	✓	✓	✓
Long Depth of Field	*	✓	✓	✓	✓	✓	✓
Ultra Close Depth of Field		✓	✓	✓	✓	✓	✓

DEFAULT SETTINGS (CONTINUED)

Default settings for “Aux” interface

The secondary scanner and the MS7320 always communicate via RS232. Data is relayed to the host via various primary interfaces.

Parameter	Default	OCIA	RS-232	Light Pen	IBM 46XX	KBW	USB
Aux Baud Rate	38400	✓	✓	✓	✓	✓	✓
Aux parity	space	✓	✓	✓	✓	✓	✓
Aux data bits	7	✓	✓	✓	✓	✓	✓
Aux stop bits	2	✓	✓	✓	✓	✓	✓
Aux character RTS	*	✓	✓	✓	✓	✓	✓
Aux message RTS		✓	✓	✓	✓	✓	✓
Aux Ack/Nak	*	✓	✓	✓	✓	✓	✓
Aux Xon/Xoff	*	✓	✓	✓	✓	✓	✓
Aux D/E commands		✓	✓	✓	✓	✓	✓
Aux M/O commands		✓	✓	✓	✓	✓	✓
Aux F/L commands		✓	✓	✓	✓	✓	✓
Aux Intercharacter Delay	1 msec	✓	✓	✓	✓	✓	✓
Aux Port Data Format	None (Disabled)	✓	✓	✓	✓	✓	✓

MS7220 STANDS

Vertical Stand Kit [MLPN 46-46405]

See page 40 for installation instructions.

Kit Includes:

- | | | |
|---------------------------------|-------------------|--------|
| a. #8 x 1 round head wood screw | [MLPN 18-18057] | Qty. 4 |
| b. M3 x .5 x 6mm pan head screw | [MLPN 18-18670] | Qty. 3 |
| c. Vertical base cover | [MLPN 36-00363] | Qty. 1 |
| d. Cable door | [MLPN 18-18057] | Qty. 2 |

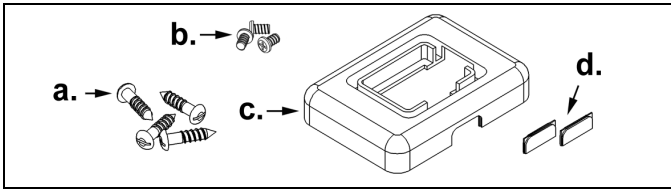

Tools required for installation:

- Flat head screw driver
- Phillips head screw driver
- ¼"-20 wrench
- Drill with #39 drill bit (*Needed for hard mount installation only*)

Optional Flex Stand Kit [MLPN 46-46404]

See 41 for installation instructions.

Kit Includes:

- | | | |
|-------------------------------|-------------------|--------|
| a. Long coupler | [MLPN 36-00324] | Qty. 1 |
| b. Bearing plate | [MLPN 36-00501] | Qty. 1 |
| c. Bellows | [MLPN 36-36615] | Qty. 1 |
| d. Flex pole | [MLPN 36-00351] | Qty. 1 |
| e. ¼"-20 x 3/8 pan head screw | [MLPN 18-18602] | Qty. 1 |

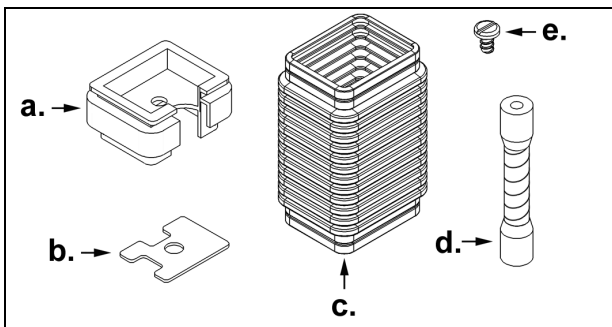

Tools required for installation:

- Flat head screw driver
- Phillips head screw driver
- ¼"-20 wrench
- Drill with #39 drill bit (*Needed for hard mount installation only*)

MS7220 STANDS

Vertical Stand Installation [MLPN 46-46405]

- 1 Remove the three screws securing the cable cover to the unit and slide it up and off the scanner.
- 2 Disconnect the cable and slide the horizontal stand up and off the unit.

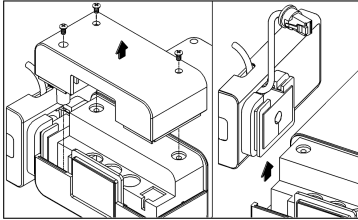

- 3 Disassemble the horizontal stand and remove the horizontal cover plate.

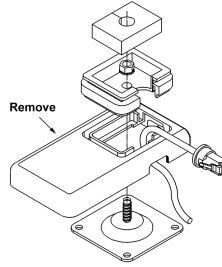

- 4 Mounting the MS7220: Peel off the base plate's tape backing and affix it to the countertop or drill four #39 pilot holes and secure the base plate to the countertop with the four #8 wood screws provided.

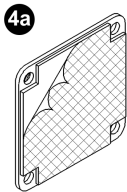

OR

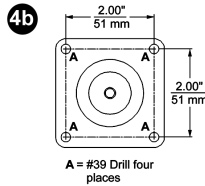

A = #39 Drill four places

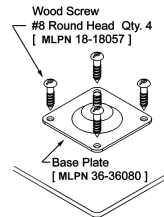

- 5 Replace the horizontal base cover with the vertical base cover [36-00363] then reassemble.

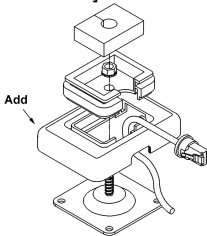

- 6 Move the side cover from the vertical to the horizontal position on the unit.

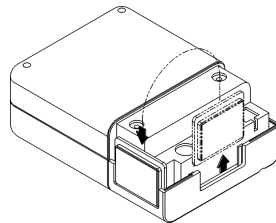

- 7 Slide the vertical stand onto the unit.

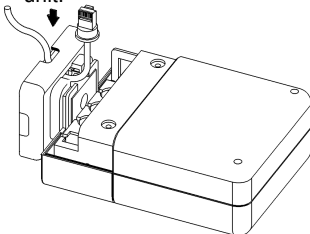

- 8 Reattach the cable and secure the cable cover with the three M3 screws.

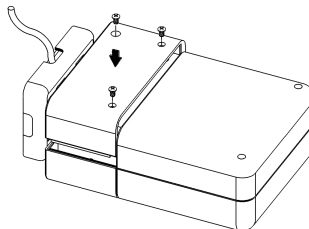

MS7220 STANDS

Optional Flexible Stand Installation [MLPN 46-46404]

- 1 Remove the three screws securing the cable cover to the unit and slide it up and off the scanner.
- 2 Disconnect the cable and slide the horizontal stand up and off the unit.

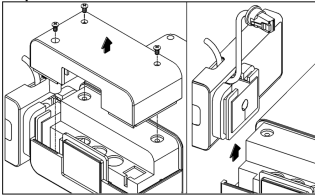

- 3 Disassemble the horizontal stand. Remove the lock nut and the short coupler. They will not be used on the flex stand.

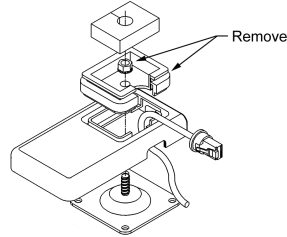

- 4 Mounting the MS7220: Peel off the base plate's tape backing and affix it to the countertop or drill four #39 pilot holes and secure the base plate to the countertop with the four #8 wood screws provided.

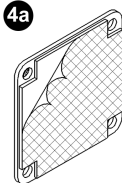

OR

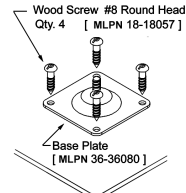
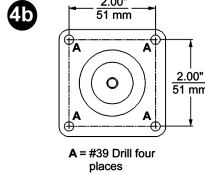

- 5 Slide the bearing plate over the stud on the base plate then attach the flex pole.

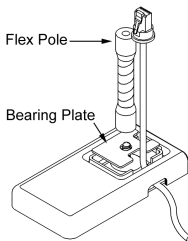

- 6 Slide the bellows over the flex pole and cable. Position the long coupler over the top of the bellows. Secure the long coupler in place with the 1/4-20 pan head screw provided then position the foam insert over the screw head.

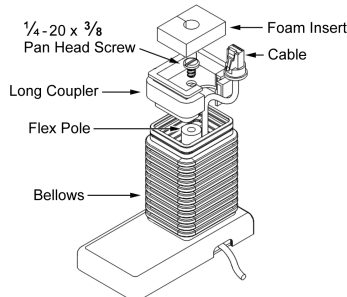

- 7 Slide the flex stand on the unit.

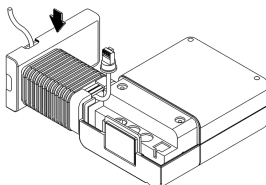

- 8 Reconnect the cable and secure the cable cover with the three M3 screws.

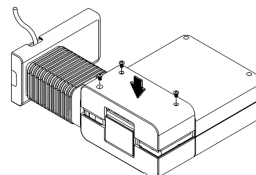

Scanner Pinout Connections

The MS7220 scanner interfaces terminate to 10-pin modular jacks located on the back of the unit. The serial # label indicates the interface enabled when the scanner is shipped from the factory.

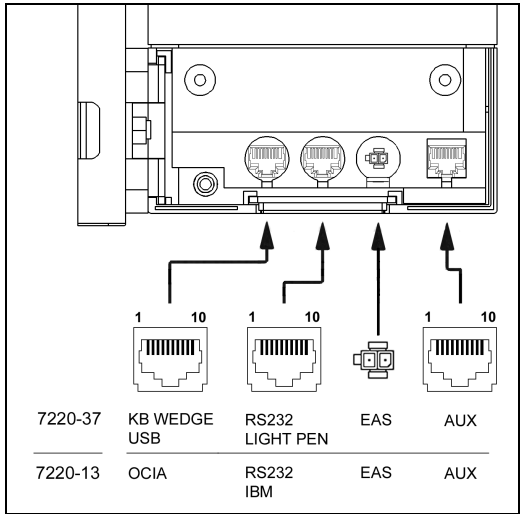

Figure 15: EAS Scanner Interface Ports

MS7220-13 OCIA	
Pin	Function
1	Ground
2	NC
3	NC
4	RDATA
5	RDATA Return
6	Clock in
7	Clock out
8	Clock in Return/ Clock out Rtrn
9	+5VDC
10	Shield Ground

MS7220-13 IBM 46xx	
Pin	Function
1	Ground
2	RS232 Transmit Output
3	RS232 Receive Input
4	RTS Output
5	CTS Input
6	DTR
7	IBM B- (D-)
8	IBM A+ (D+)
9	+5V IN
10	NC

Continued next page

SCANNER AND CABLE TERMINATIONS (CONTINUED)

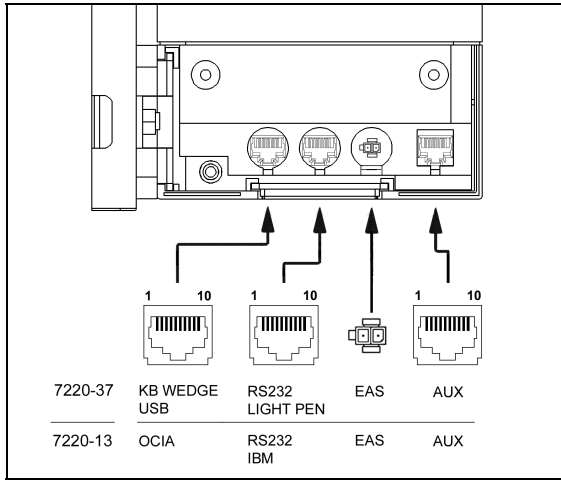

Figure 16: Scanner Interface Ports

MS7220-37 Keyboard Wedge, Stand Alone Keyboard or USB	
Pin	Function
1	Ground
2	USB D-
3	USB D+
4	PC Data
5	PC Clock
6	KB Clock
7	PC +5V, V-USB
8	KB Data
9	+5VDC
10	Shield Ground

MS7220-37 RS-232 or Light Pen	
Pin	Function
1	Ground
2	RS-232 Transmit Output
3	RS-232 Receive Input
4	RTS Output
5	CTS Input
6	DTR Input/LTPN Source
7	Reserved
8	LTPN Data
9	+5VDC
10	Shield Ground

MS7220-13/37 Auxiliary Port RS232 IN Only	
Pin	Function
1	Ground
2	RS-232 Receive Input
3	RS-232 Transmit Output
4	RTS in
5	CTS out
6-10	NC

SCANNER AND CABLE TERMINATIONS (CONTINUED)

Cable Connector Configurations (Host End)

PowerLink Cable MLPN 54-54xxx*	
Pin	Function
1	Shield Ground
2	RS-232 Transmit Output
3	RS-232 Receive Input
4	DTR Input
5	Power/Signal Ground
6	Reserved
7	CTS Input
8	RTS Output
9	+5VDC

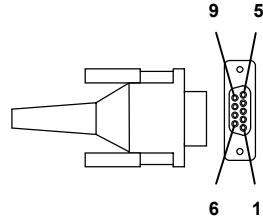

9-Pin D-Type Conn.

xxx* specifies connection to the host

USB PowerLink Cable (MLPN 54-54165, Type A)	
Pin	Function
1	N/C
2	D-
3	D+
4	Ground



USB Type A (Top)
Locking Type A (Bottom)

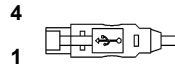

PowerLink, RS232 AUX Cable MLPN 54-54667	
Pin	Function
1	Ground
2	RS-232 Transmit Output
3	RS-232 Receive Input
4	RTS Output
5	CTS Input
6-10	N/C

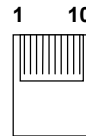

10-pin Modular Plug

Stand Alone Keyboard Cable MLPN 54-54020	
Pin	Function
1	PC Data
2	NC
3	Power Ground
4	+5VDC PC Power to KB
5	PC Clock
6	NC

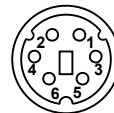

6-Pin Male Mini-DIN Conn.

Cable Connector Configuration

The PowerLink cable is terminated with a 5-pin DIN female connector on one end, and a 6-pin mini DIN male on the other.

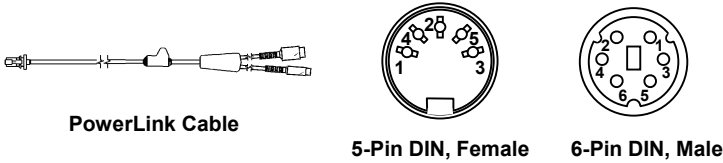

Metrologic will supply an adapter cable with a 5-pin DIN male connector on one end and a 6-pin mini DIN female connector on the other.

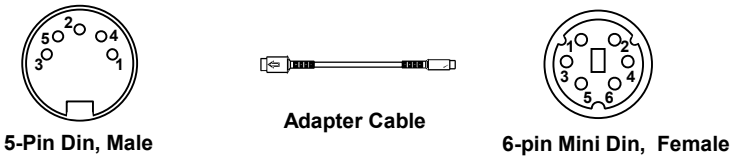

According to the termination required, connect the appropriate end of the adapter cable to the PowerLink cable, leaving the necessary termination exposed for connecting to the keyboard and the keyboard port on the PC. The pin assignments are as follows:

PowerLink Cable

5-pin Female DIN	
Pin	Function
1	Keyboard Clock
2	Keyboard Data
3	No Connect
4	Power Ground
5	+5 Volts DC
6-pin Male Mini-DIN	
Pin	Function
1	Keyboard Data
2	No Connect
3	Power Ground
4	+5 Volts DC
5	PC Clock
6	No Connect

Adapter Cable

5-pin Male DIN	
Pin	Function
1	PC Clock
2	PC Data
3	No Connect
4	Power Ground
5	+5 Volts DC
6-pin Female Mini-DIN	
Pin	Function
1	Keyboard Data
2	No Connect
3	Power Ground
4	+5 Volts DC
5	Keyboard Clock
6	No Connect

LIMITED WARRANTY

The MS7220 scanners are manufactured by Metrologic at its Blackwood, New Jersey, U.S.A. facility. The MS7220 scanners have a two (2) year limited warranty from the date of manufacture. Metrologic warrants and represents that all MS7220 scanners are free of all defects in material, workmanship and design, and have been produced and labeled in compliance with all applicable U.S. Federal, state and local laws, regulations and ordinances pertaining to their production and labeling.

This warranty is limited to repair, replacement of Product or refund of Product price at the sole discretion of Metrologic. Faulty equipment must be returned to the Metrologic facility in Blackwood, New Jersey, U.S.A. or Puchheim, Germany. To do this, contact Metrologic's Customer Service/Repair Department to obtain a Returned Material Authorization (RMA) number.

In the event that it is determined the equipment failure is covered under this warranty, Metrologic shall, at its sole option, repair the Product or replace the Product with a functionally equivalent unit and return such repaired or replaced Product without charge for service or return freight, whether distributor, dealer/reseller, or retail consumer, or refund an amount equal to the original purchase price.

This limited warranty does not extend to any Product which, in the sole judgement of Metrologic, has been subjected to abuse, misuse, neglect, improper installation, or accident, nor any damage due to use or misuse produced from integration of the Product into any mechanical, electrical or computer system. The warranty is void if the case of Product is opened by anyone other than Metrologic's repair department or authorized repair centers.

THIS LIMITED WARRANTY, EXCEPT AS TO TITLE, IS IN LIEU OF ALL OTHER WARRANTIES OR GUARANTEES, EITHER EXPRESS OR IMPLIED, AND SPECIFICALLY EXCLUDES, WITHOUT LIMITATION, WARRANTIES OF MERCHANTABILITY AND FITNESS FOR A PARTICULAR PURPOSE UNDER THE UNIFORM COMMERCIAL CODE, OR ARISING OUT OF CUSTOM OR CONDUCT. THE RIGHTS AND REMEDIES PROVIDED HEREIN ARE EXCLUSIVE AND IN LIEU OF ANY OTHER RIGHTS OR REMEDIES. IN NO EVENT SHALL METROLOGIC BE LIABLE FOR ANY INDIRECT OR CONSEQUENTIAL DAMAGES, INCIDENTAL DAMAGES, DAMAGES TO PERSON OR PROPERTY, OR EFFECT ON BUSINESS OR PROPERTY, OR OTHER DAMAGES OR EXPENSES DUE DIRECTLY OR INDIRECTLY TO THE PRODUCT, EXCEPT AS STATED IN THIS WARRANTY. IN NO EVENT SHALL ANY LIABILITY OF METROLOGIC EXCEED THE ACTUAL AMOUNT PAID TO METROLOGIC FOR THE PRODUCT. METROLOGIC RESERVES THE RIGHT TO MAKE ANY CHANGES TO THE PRODUCT DESCRIBED HEREIN.

Corporate Headquarters

Metrologic Instruments, Inc.
90 Coles Road
Blackwood, NJ 08012-4683

Customer Service: 1-800-ID-METRO
Tel: 856-228-8100
Fax: 856-228-6673
Email: info@metrologic.com
Website: www.metrologic.com

Germany

Metrologic Instruments GmbH
Dornierstrasse 2
82178 Puchheim b.
Munich, Germany

Tel: 49-89-89019-0
Fax: 49-89-89019-200
Email: info@europa.metrologic.com

Notice

This device complies with Part 15 of the FCC Rules. Operation is subject to the following two conditions: (1) This device may not cause harmful interference, and (2) this device must accept any interference received, including interference that may cause undesired operation.

This equipment has been tested and found to comply with the limits for a Class B digital device, pursuant to Part 15 of the FCC rules. These limits are designed to provide reasonable protection against harmful interference in a residential installation. This equipment generates, uses and can radiate radio frequency energy and, if not installed and used in accordance with the instructions, may cause harmful interference to radio communications. However, there is no guarantee that interference will not occur in a particular installation. If this equipment does cause harmful interference to radio or television reception, which can be determined by turning the equipment off and on, the user is encouraged to try to correct the interference by one or more of the following measures:

- Reorient or relocate the receiving antenna
- Increase the separation between the equipment and receiver
- Connect the equipment into an outlet on a circuit different from that to which the receiver is connected
- Consult the dealer or an experienced radio/TV technician for help

Notice

This Class B digital apparatus complies with Canadian ICES-003.

Avertissement

Cet appareil numérique de la class B est conforme à la norme NMB-003.

Caution

Use of controls or adjustments or performance of procedures other than those specified herein may result in hazardous laser light exposure. Under no circumstances should the customer attempt to service the laser scanner. Never attempt to look at the laser beam, even if the scanner appears to be nonfunctional. Never open the scanner in an attempt to look into the device. Doing so could result in hazardous laser light exposure. The use of optical instruments with the laser equipment will increase eye hazard.

Atención

La modificación de los procedimientos, o la utilización de controles o ajustes distintos de los especificados aquí, pueden provocar una luz de láser peligrosa. Bajo ninguna circunstancia el usuario deberá realizar el mantenimiento del láser del escáner. Ni intentar mirar al haz del láser incluso cuando este no esté operativo. Tampoco deberá abrir el escáner para examinar el aparato. El hacerlo puede conllevar una exposición peligrosa a la luz de láser. El uso de instrumentos ópticos con el equipo láser puede incrementar el riesgo para la vista.

Attention

L'emploi de commandes, réglages ou procédés autres que ceux décrits ici peut entraîner de graves irradiations. Le client ne doit en aucun cas essayer d'entretenir lui-même le scanner ou le laser. Ne regardez jamais directement le rayon laser, même si vous croyez que le scanner est inactif. N'ouvrez jamais le scanner pour regarder dans l'appareil. Ce faisant, vous vous exposez à une rayonnement laser qui est dangereux. L'emploi d'appareils optiques avec cet équipement laser augmente le risque d'endommagement de la vision.

Achtung

Die Verwendung anderer als der hier beschriebenen Steuerungen, Einstellungen oder Verfahren kann eine gefährliche Laserstrahlung hervorrufen. Der Kunde sollte unter keinen Umständen versuchen, den Laser-Scanner selbst zu warten. Sehen Sie niemals in den Laserstrahl, selbst wenn Sie glauben, daß der Scanner nicht aktiv ist. Öffnen Sie niemals den Scanner, um in das Gerät hineinzusehen. Wenn Sie dies tun, können Sie sich einer gefährlichen Laserstrahlung aussetzen. Der Einsatz optischer Geräte mit dieser Laserausrüstung erhöht das Risiko einer Sehschädigung.

Attenzione

L'utilizzo di sistemi di controllo, di regolazioni o di procedimenti diversi da quelli descritti nel presente Manuale può provocare delle esposizioni a raggi laser rischiose. Il cliente non deve assolutamente tentare di riparare egli stesso lo scanner laser. Non guardate mai il raggio laser, anche se credete che lo scanner non sia attivo. Non aprite mai lo scanner per guardare dentro l'apparecchio. Facendolo potete esporVi ad una esposizione laser rischiosa. L'uso di apparecchi ottici, equipaggiati con raggi laser, aumenta il rischio di danni alla vista.

PATENTS

“Patent Information

This METROLOGIC product may be covered by one or more of the following U.S. Patents:

U.S. Patent No.;

4,960,985; 5,081,342; 5,216,232; 5,260,553; 5,340,971; 5,343,027;
5,557,093; 5,627,359; 5,637,852; 5,661,292; 5,686,717; 5,777,315;
5,789,731; 5,828,049; 6,029,894; 6,098,885; 6,209,789;

4,360,798; 4,369,361; 4,387,297; 4,460,120; 4,496,831; 4,593,186;
4,607,156; 4,673,805; 4,736,095; 4,758,717; 4,816,660; 4,845,350;
4,896,026; 4,923,281; 4,933,538; 4,992,717; 5,081,342; 5,015,833;
5,017,765; 5,059,779; 5,117,098; 5,124,539; 5,130,520; 5,132,525;
5,140,144; 5,149,950; 5,180,904; 5,200,599; 5,229,591; 5,247,162;
5,250,790; 5,250,791; 5,250,792; 5,260,553; 5,262,628; 5,280,162;
5,280,164; 5,304,788; 5,321,246; 5,324,924; 5,340,973; 5,396,053;
5,396,055; 5,408,081; 5,410,139; 5,424,525; 5,436,440; 5,449,891;
5,468,949; 5,468,951; 5,479,000; 5,484,992; 5,525,789; 5,528,024;
5,532,469; 5,545,889; 5,591,953; 5,616,908; 5,627,359

No license right or sublicense is granted, either expressly or by implication, estoppel, or otherwise, under any METROLOGIC or third party intellectual property rights (whether or not such third party rights are licensed to METROLOGIC), including any third party patent listed above, except for an implied license only for the normal intended use of the specific equipment, circuits, and devices represented by or contained in the METROLOGIC products that are physically transferred to the user, and only to the extent of METROLOGIC'S license rights and subject to any conditions, covenants and restrictions therein.”

Other worldwide patents pending.

INDEX

A

Accessories 2
Adapter 2, 45
Audible 16
Autodiscriminates 31

B

Bar Code 20, 21, 22
Beep 16, 34

C

Cable 2, 5, 9, 13, 27, 28, 31, 39,
42-45
Caution 5, 6, 7, 8, 9, 11
CE 48
Communication 30, 34
Connector 44, 45
Customer Service 2, 46

D

Decode Capability 31
Default Settings 33-38
Design Specifications 31, 32

E

EAS 23
Electrical 32
Extended Depth of Field 37

F

Failure Modes 17
Function 37, 42-45

G

Ground 42-45

H

Host 11

I

Indicators 16, 18, 31
Input Voltage 32
Installation 2, 5, 6, 9-12, 39, 40, 41
Interfaces 5, 7-10, 24

K

Keyboard Type 30
Keyboard Wedge 1, 2, 6, 30, 31, 43

L

Labels 19
LED 13, 16, 18, 24, 25, 31
Light Levels 32
Light Pen 1, 2, 10, 30-31, 33-38, 43
Light Source 31

M

Maintenance 23
Mechanical 31
Min Bar Width 31
Modes 14

N

Normal Depth of Field 37
Notices 48

O

OCIA 1, 2, 5, 30, 31, 33-38, 42
Operating Current 32
Operation 31
Operational 31
Output Window 13

P

Parts 13
Patents 48
Port 38, 43
Power Save 14
Programming Guide 2, 16, 28, 30
Protocols 30

R

Razberry Tone 16, 17, 34
RDATA 42
Repair 46

S

Scan Lines 31
Scan Pattern 31
Scan Speed 31
Specifications 20-22, 31, 32
Stand 2, 31, 39, 40, 41
Storage 32
System Interfaces 31

T

Termination 31
Transformers 32
Troubleshooting 24-28

V

Ventilation 32
Visual 18
Voltage 5-9, 11

W

Warranty 46
Weight 31

July 2003

Printed in USA



0 0 - 0 2 5 4 B