

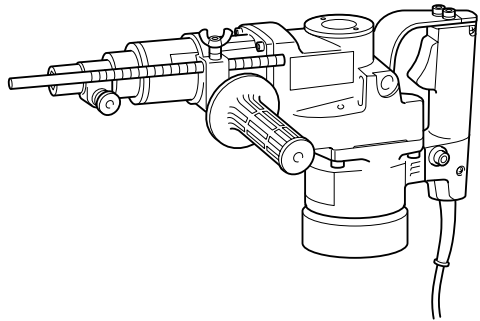

# Rotary Hammer

38 mm (1 - 1/2")  
MODEL HR3851



003098

## I N S T R U C T I O N M A N U A L

**⚠ WARNING:**

For your personal safety, READ and UNDERSTAND before using.  
SAVE THESE INSTRUCTIONS FOR FUTURE REFERENCE.

[www.makitatools.com](http://www.makitatools.com)

---

# SPECIFICATIONS

Model		HR3851
Capacities	Carbide-tipped bit	38 mm (1-1/2")
	Core bit	118 mm (4-5/8")
No load speed (RPM)		240/min.
Blows per minute		2,900
Overall length		445 mm (17-1/2")
Net weight		7.5 kg (16.5 lbs)

- Manufacturer reserves the right to change specifications without notice.
- Specifications may differ from country to country.

---

# GENERAL SAFETY RULES

USA001-2

(For All Tools)

## **WARNING:**

**Read and understand all instructions.** Failure to follow all instructions listed below, may result in electric shock, fire and/or serious personal injury.

---

# SAVE THESE INSTRUCTIONS

## Work Area

1. **Keep your work area clean and well lit.** Cluttered benches and dark areas invite accidents.
2. **Do not operate power tools in explosive atmospheres, such as in the presence of flammable liquids, gases, or dust.** Power tools create sparks which may ignite the dust or fumes.

3. **Keep bystanders, children, and visitors away while operating a power tool.** Distractions can cause you to lose control.

## Electrical Safety

4. **Grounded tools must be plugged into an outlet properly installed and grounded in accordance with all codes and ordinances. Never remove the grounding prong or modify the plug in any way. Do not use any adaptor plugs. Check with a qualified electrician if you are in doubt as**

- to whether the outlet is properly grounded. If the tools should electrically malfunction or break down, grounding provides a low resistance path to carry electricity away from the user.
- 5. Avoid body contact with grounded surfaces such as pipes, radiators, ranges and refrigerators.** There is an increased risk of electric shock if your body is grounded.
  - 6. Do not expose power tools to rain or wet conditions.** Water entering a power tool will increase the risk of electric shock.
  - 7. Do not abuse the cord. Never use the cord to carry the tools or pull the plug from an outlet. Keep cord away from heat, oil, sharp edges or moving parts. Replace damaged cords immediately.** Damaged cords increase the risk of electric shock.
  - 8. When operating a power tool outside, use an outdoor extension cord marked “W-A” or “W”.** These cords are rated for outdoor use and reduce the risk of electric shock.

## Personal Safety

- 9. Stay alert, watch what you are doing and use common sense when operating a power tool. Do not use tool while tired or under the influence of drugs, alcohol, or medication.** A moment of inattention while operating power tools may result in serious personal injury.
- 10. Dress properly. Do not wear loose clothing or jewelry. Contain long hair. Keep your hair, clothing, and gloves away from moving parts.** Loose clothes, jewelry, or long hair can be caught in moving parts.
- 11. Avoid accidental starting. Be sure switch is off before plugging in.** Carrying tools with your finger on the switch or plugging in tools that have the switch on invites accidents.
- 12. Remove adjusting keys or wrenches before turning the tool on.** A wrench or a key that is left attached to a rotating part of the tool may result in personal injury.
- 13. Do not overreach. Keep proper footing and balance at all times.** Proper footing and balance enables better control of the tool in unexpected situations.
- 14. Use safety equipment. Always wear eye protection.** Dust mask, non-skid safety shoes, hard hat, or hearing protection must be used for appropriate conditions. Ordinary eye or sun glasses are NOT eye protection.

## Tool Use and Care

- 15. Use clamps or other practical way to secure and support the workpiece to a stable platform.** Holding the work by hand or against your body is unstable and may lead to loss of control.
- 16. Do not force tool. Use the correct tool for your application.** The correct tool will do the job better and safer at the rate for which it is designed.
- 17. Do not use tool if switch does not turn it on or off.** Any tool that cannot be controlled with the switch is dangerous and must be repaired.
- 18. Disconnect the plug from the power source before making any adjustments, changing accessories, or storing the tool.** Such preventive safety measures reduce the risk of starting the tool accidentally.
- 19. Store idle tools out of reach of children and other untrained persons.** Tools are dangerous in the hands of untrained users.
- 20. Maintain tools with care. Keep cutting tools sharp and clean.** Properly maintained tools with sharp cutting edges are less likely to bind and are easier to control.
- 21. Check for misalignment or binding of moving parts, breakage of parts, and any other condition that may affect the tools operation. If damaged, have the tool serviced before using.** Many accidents are caused by poorly maintained tools.
- 22. Use only accessories that are recommended by the manufacturer for your**

**model.** Accessories that may be suitable for one tool, may become hazardous when used on another tool.

**SERVICE**

**23. Tool service must be performed only by qualified repair personnel.** Service or main-

tenance performed by unqualified personnel could result in a risk of injury.

**24. When servicing a tool, use only identical replacement parts. Follow instructions in the Maintenance section of this manual.**

Use of unauthorized parts or failure to follow Maintenance instructions may create a risk of electric shock or injury.

**USE PROPER EXTENSION CORD:** Use only three-wire extension cords that have three-prong grounding-type plugs and three-pole receptacles that accept the tool's plug. Make sure your extension cord is in good condition. Replace or repair damaged or worn cord immediately. When using an extension cord, be sure to use one heavy enough to carry the current your product will draw. An undersized cord will cause a drop in line voltage resulting in loss of power and overheating. Table 1 shows the correct size to use depending on cord length and nameplate ampere rating. If in doubt, use the next heavier gage. The smaller the gage number, the heavier the cord.

**Table 1: Minimum gage for cord**

Ampere Rating		Volts	Total length of cord in feet				
		120 V	25 ft.	50 ft.	100 ft.	150 ft.	
More Than	Not More Than	AWG					
0	6		18	16	16	14	
6	10		18	16	14	12	
10	12		16	16	14	12	
12	16		14	12	Not Recommended		

**GROUNDING INSTRUCTIONS**

This tool should be grounded while in use to protect the operator from electric shock. The tool is equipped with a three-conductor cord and three-prong grounding type plug to fit the proper grounding type receptacle. The green (or green and yellow) conductor in the cord is the grounding wire. Never connect the green (or green and yellow) wire to a live terminal. Your unit is for use on 120 volts and has a plug that looks like Fig. "A".

An adapter Fig. "B" and "C" is available for connecting Fig. "A" type plugs to two-prong receptacles. The green-colored rigid ear, lug, etc., extending from the adapter must be connected to a permanent ground, such as a properly grounded outlet box.

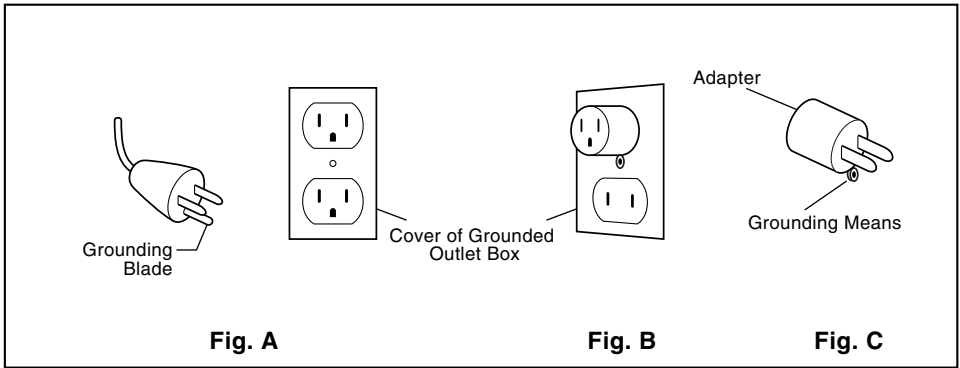

## SPECIFIC SAFETY RULES

USB010-2

**DO NOT** let comfort or familiarity with product (gained from repeated use) replace strict adherence to rotary hammer safety rules. If you use this tool unsafely or incorrectly, you can suffer serious personal injury.

1. Hold tools by insulated gripping surfaces when performing an operation where the cutting tool may contact hidden wiring or its own cord. Contact with a "live" wire will make exposed metal parts of the tool "live" and shock the operator.
2. Wear ear protectors when using the tool for extended periods. Prolonged exposure to high intensity noise can cause hearing loss.
3. Wear a hard hat (safety helmet), safety glasses and/or face shield. Ordinary eye or sun glasses are NOT safety glasses. It is also highly recommended that you wear a dust mask and thickly padded gloves.
4. Be sure the bit is secured in place before operation.
5. Under normal operation, the tool is designed to produce vibration. The screws can come loose easily, causing a breakdown or accident. Check tightness of screws carefully before operation.
6. In cold weather or when the tool has not been used for a long time, let the tool warm up for a while by operating it under no load. This will loosen up the lubrication. Without proper warm-up, hammering operation is difficult.
7. Always be sure you have a firm footing. Be sure no one is below when using the tool in high locations.

- 
8. Hold the tool firmly with both hands.
  9. Keep hands away from moving parts.
  10. Do not leave the tool running. Operate the tool only when hand-held.
  11. Do not point the tool at any one in the area when operating. The bit could fly out and injure someone seriously.
  12. Do not touch the bit or parts close to the bit immediately after operation; they may be extremely hot and could burn your skin.
  13. Some material contains chemicals which may be toxic. Take caution to prevent dust inhalation and skin contact. Follow material supplier safety data.

---

## SAVE THESE INSTRUCTIONS

**⚠ WARNING:**  
**MISUSE** or failure to follow the safety rules stated in this instruction manual may cause serious personal injury.

# FUNCTIONAL DESCRIPTION

## ⚠ CAUTION:

- Always be sure that the tool is switched off and unplugged before adjusting or checking function on the tool.

## Switch action

### ⚠ CAUTION:

- Before plugging in the tool, always check to see that the switch trigger actuates properly and returns to the “OFF” position when released.

To start the tool, simply pull the switch trigger. Release the switch trigger to stop.

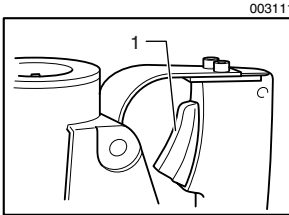

1. Switch trigger

## Selecting the action mode

### Rotation with hammering

For drilling in concrete, masonry, etc., rotate the change lever to the  symbol.

### Hammering only

For chipping, scaling or demolition operations, rotate the change lever to the  symbol.

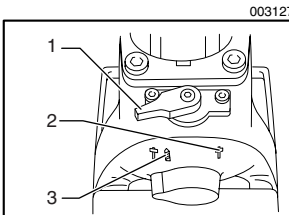

1. Change lever
2. For hammering only
3. For rotation with hammering

### ⚠ CAUTION:

- Do not rotate the change lever when the tool is running under load. The tool will be damaged.
- To avoid rapid wear on the mode change mechanism, be sure that the change lever is always positively located in one of the two action mode positions.

# ASSEMBLY

## ⚠ CAUTION:

- Always be sure that the tool is switched off and unplugged before carrying out any work on the tool.

### Side grip (auxiliary handle)

For maximum control and safer operation, always use the side grip with this tool. The side grip swings around to either side, allowing easy handling of the tool in any position. Loosen the side grip by turning it counterclockwise, swing it to the desired position and then tighten it by turning clockwise.

003146

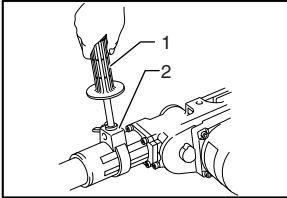

1. Side grip
2. Grip base

003149

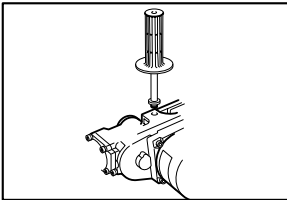

The side grip can also be installed in the position shown in the figure. Remove the side grip from the grip base by turning the side grip counterclockwise. Screw the side grip on either side of the tool, whichever is convenient.

### Installing or removing the bit

Press in the tool retainer and turn it until the red dots on the tool retainer and the tool holder are aligned. Release the tool retainer.

003153

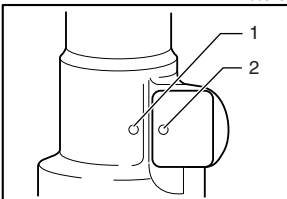

1. Red dot (Tool holder)
2. Red dot (Tool retainer)

003154

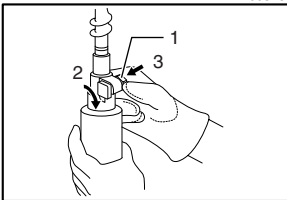

1. Tool retainer
2. Turn 180°
3. Press in

Insert the bit into the tool holder as far as it will go. Press in the tool retainer and turn it a full 180 degrees. Then release it to secure the bit.

To remove the bit, follow the installation procedure in reverse.



003183

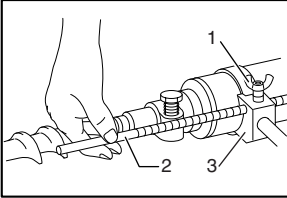

1. Clamp screw
2. Depth gauge
3. Grip base

## Depth gauge

The depth gauge is convenient for drilling holes of uniform depth. Insert the depth gauge into the hole in the grip base. Adjust the depth gauge to the desired depth and then tighten the clamp screw to secure the depth gauge.

### NOTE:

- The depth gauge cannot be used at the position where the depth gauge strikes against the tool body.

## OPERATION

003199

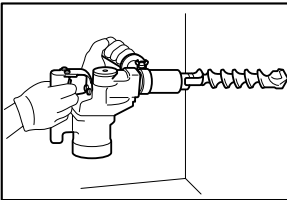

## Hammer drilling operation

Set the change lever to the  symbol.

Position the bit at the desired location for the hole, then pull the switch trigger. Do not force the tool. Light pressure gives best results. Keep the tool in position and prevent it from slipping away from the hole.

Do not apply more pressure when the hole becomes clogged with chips or particles. Instead, run the tool at an idle, then remove the bit partially from the hole. By repeating this several times, the hole will be cleaned out and normal drilling may be resumed.

### ⚠ CAUTION:

- There is a tremendous and sudden twisting force exerted on the tool/bit at the time of hole break-through, when the hole becomes clogged with chips and particles, or when striking reinforcing rods embedded in the concrete. Always use the side grip (auxiliary handle) and firmly hold the tool by both side grip and switch handle during operations. Failure to do so may result in the loss of control of the tool and potentially severe injury.

002449

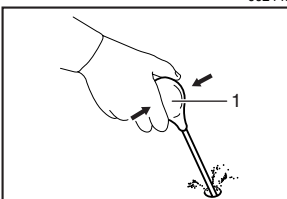

1. Blow-out bulb

## Blow-out bulb (optional accessory)

After drilling the hole, use the blow-out bulb to clean the dust out of the hole.

003205

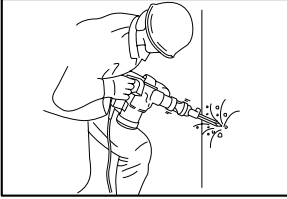

## Chipping/Scaling/Demolition

Set the change lever to the  symbol.

Hold the tool firmly with both hands. Turn the tool on and apply slight pressure on the tool so that the tool will not bounce around, uncontrolled. Pressing very hard on the tool will not increase the efficiency.

## Core bit (optional accessory)

### When using the center bit

003209

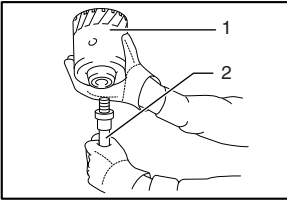

1. Core bit
2. Adapter

Screw the core bit on the adapter. Install the adapter with the core bit in the tool in the same manner as a drill bit.

003210

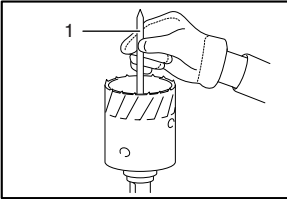

1. Center bit

Install the center bit.

003211

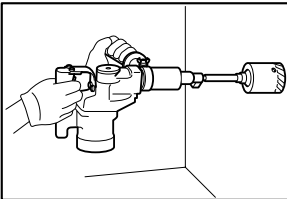

Rest the core bit on the concrete and turn the tool on. Once the core bit has cut a shallow groove into the concrete, remove the center bit. Then resume drilling.

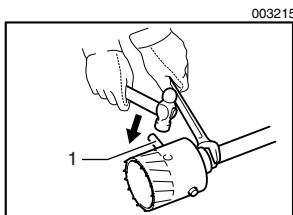
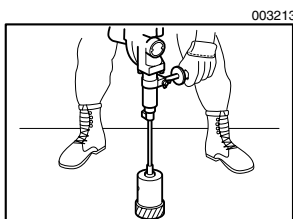

1. Rod

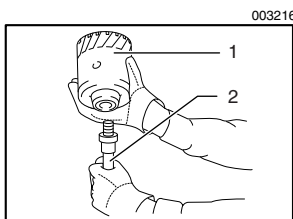

1. Core bit  
2. Adapter

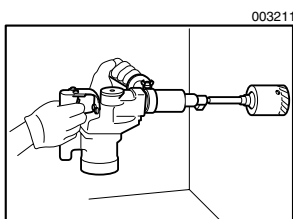



To remove the core bit, follow the procedures 1 or 2.

1. Rotate the change lever to the  position. Then rest the core bit on the concrete and turn the tool on. The core bit will come loose from the hammering action.
2. Hold the adapter with the wrench, insert the rod (optional accessory) into the hole in the core bit and tap with a hammer to unscrew.

### When not using the center bit

Screw the core bit on the adapter. Install the adapter with the core bit in the tool in the same manner as a drill bit.

Rotate the change lever to the  position. Rest the core bit on the concrete and turn the tool on. Once the core bit has cut a shallow groove into the concrete, rotate the change lever to the  position and resume drilling.

### NOTE:

- No problem is caused even if the core bit unscrews slightly during brief use since the core bit rotates in the tightening direction.

To remove the core bit, follow the same removal procedures covered in “When using the center bit”.

## MAINTENANCE

### CAUTION:

- Always be sure that the tool is switched off and unplugged before attempting to perform inspection or maintenance.

001146

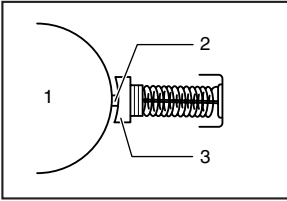

1. Commutator
2. Insulating tip
3. Carbon brush

## Replacing carbon brushes

When the resin insulating tip inside the carbon brush is exposed to contact the commutator, it will automatically shut off the motor. When this occurs, both carbon brushes should be replaced. Keep the carbon brushes clean and free to slip in the holders. Both carbon brushes should be replaced at the same time. Use only identical carbon brushes.

003225

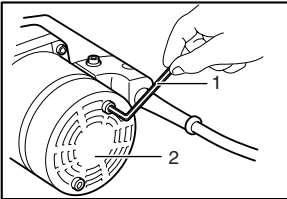

1. Hex wrench
2. Rear cover

Use a hex wrench to remove the rear cover.

003231

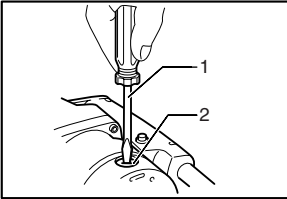

1. Screwdriver
2. Brush holder cap

Use a screwdriver to remove the brush holder caps. Take out the worn carbon brushes, insert the new ones and secure the brush holder caps.

## Lubrication

This tool requires no hourly or daily lubrication because it has a grease-packed lubrication system. It should be relubricated after every 6 months of operation. Send the complete tool to Makita Authorized or Factory Service Center for this lubrication service. However, if circumstances require that you should lubricate it by yourself, proceed as follows.

Run the tool for several minutes to warm it up. Switch off and unplug the tool.

Remove the crank cap using a Makita lock nut wrench 35 (optional accessory). Rest the tool on the table with the bit end pointing upwards. This will allow the old grease to collect inside the crank housing.

003236

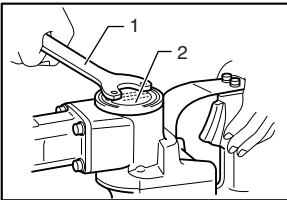

1. Lock nut wrench
2. Crank cap

---

Wipe out the old grease inside and replace with a fresh grease (60 g; 2 oz). Use only Makita genuine hammer grease (optional accessory). Filling with more than the specified amount of grease (approx. 60 g; 2 oz) can cause faulty hammering action or tool failure. Fill only with the specified amount of grease.

Reinstall the crank cap and tighten with the lock nut wrench.

**⚠ CAUTION:**

- Do not tighten the crank cap excessively. It is made of resin and is subject to breakage.

To maintain product SAFETY and RELIABILITY, repairs, any other maintenance or adjustment should be performed by Makita Authorized or Factory Service Centers, always using Makita replacement parts.

## ACCESSORIES

**⚠ CAUTION:**

- These accessories or attachments are recommended for use with your Makita tool specified in this manual. The use of any other accessories or attachments might present a risk of injury to persons. Only use accessory or attachment for its stated purpose.

If you need any assistance for more details regarding these accessories, ask your local Makita service center.

- Spline shank Carbide-tipped bits
- Bull point
- Cold chisel
- Scaling chisel
- Grooving chisel
- Spline shank to A-Taper adapter
- Spline shank to SDS adapter
- Core bit
- Core bit adapter
- Hammer grease
- Depth gauge
- Blow-out bulb
- Safety goggles
- Lock nut wrench 35
- Hex wrench
- Plastic carrying case









Cut



First-Class  
Postage  
Required

Post Office will  
not deliver  
without proper  
postage.

**Makita U.S.A., Inc.**  
14930 Northam Street  
La Mirada, CA 90638-5753



Fold

# MAIL THIS PORTION

Your answers to the following questions are appreciated.

**1. This product was purchased from:**

- Home Center       Other (                    )  
 Hardware/Lumber Store  
 Tool Distributor  
 Industrial Supply  
 Construction Supply

**3. How did you learn about this product:**

- Magazine       Radio  
 From Dealer       Exhibition  
 Newspaper       From Friend  
 Store Display       Previous Usage  
 Catalog       Other (                    )

**2. Use of the product is intended for:**

- Construction Trade  
 Industrial Maintenance  
 Home Maintenance  
 Hobby  
 Other (                    )

**4. Most favored points are:**

- Design       Repair Service  
 Features       Durability  
 Size       Power  
 Price       Other (                    )  
 Makita Brand

**5. Any comments:**

---



---



---



---

DATE PURCHASED			MODEL NO.														
MONTH		DAY		YEAR		SERIAL NO.											
INTL. LAST NAME / COMPANY NAME											STATUS		SEX				
											Married Single		M F				
STREET ADDRESS																	
CITY																	
STATE		ZIP CODE			PHONE			AREA CODE									
AGE:		<input type="checkbox"/> Under 19		<input type="checkbox"/> 20-29		<input type="checkbox"/> 30-39		<input type="checkbox"/> 40-49		<input type="checkbox"/> 50-60		<input type="checkbox"/> Over 60					

BE SURE TO COMPLETE THE CUSTOMER'S PORTION OF THIS FORM AND RETAIN FOR YOUR RECORDS.

Please return this portion by facsimile or mail.

Facsimile No: (714) 522-8133

# FACTORY SERVICE CENTERS

1-800-4-MAKITA

RETAIN THIS PORTION FOR YOUR RECORDS

## ALABAMA

2365 Pelham Parkway  
Pelham, AL 35124  
(205) 620-1791

## ARIZONA

3707 E. Broadway Rd., Ste. 6  
Phoenix, AZ 85040  
(602) 437-2850

## ARKANSAS

Shackelford Shopping Center  
240 South Shackelford Rd.,  
Ste. C  
Little Rock, AR 72211  
(501) 224-5733

## CALIFORNIA

41850 Christy St.  
Fremont, CA 94538-5107  
(510) 657-9881

1421 N. Clovis Ave., Ste. 112  
Fresno, CA 93727  
(559) 252-5166

14930 Northam St.  
La Mirada, CA 90638-5753  
(714) 522-9089

1970 Fulton Avenue  
Sacramento, CA 95825  
(916) 482-5197

1440 South "E" Street  
San Bernardino, CA 92408  
(909) 885-1289

7674 Clairemont Mesa Blvd.  
San Diego, CA 92111  
(858) 278-4471

1714 E. McFadden Ave., Unit M  
Santa Ana, CA 92705  
(714) 667-5066

1565 Winchester B.  
Campbell, CA 95008-0501  
(408) 379-0377

16735 Satcoy St., Ste. 105  
Van Nuys, CA 91406  
(818) 782-2440

## COLORADO

11839 E. 51st Ave.  
Denver, CO 80239-2709  
(303) 371-2850

## CONNECTICUT

508 Spring St.  
Windsor Locks, CT 06096  
(860) 292-6405

## FLORIDA

620 Douglas Ave. Suite 1302  
Altamonte Springs, FL 32714  
(407) 774-6000

750 East Sample Road  
Pompano Beach, FL 33064  
(954) 781-6333

Thompson Center Waters  
5501 W. Waters Ave., Ste. 406  
Tampa, FL 33634  
(813) 886-8292

## GEORGIA

4680 River Green Parkway  
Duluth, GA 30096-2566  
(770) 476-8911

## HAWAII

4510 Salt Lake Blvd., Suite A7  
Honolulu, HI 96818  
(808) 847-0038

## ILLINOIS

1450 Feehanville Dr.  
Mt. Prospect, IL 60056-6011  
(847) 297-3100

## INDIANA

8403 Michigan Road, Unit 1  
Indianapolis, IN 46268  
(317) 334-9980

## KANSAS

8819 W. 95th St.  
Overland Park, KS 66212  
(913) 642-1111

## KENTUCKY

1215 S. Hurstbourne Parkway  
Louisville, KY 40222  
(502) 326-3740

## LOUISIANA

5626 Jefferson Hwy.  
Harahan, LA 70123  
(504) 733-4138

## MARYLAND

7541 - 45 Ritchie Highway  
Glen Burnie, MD 21061  
(410) 590-0160

## MASSACHUSETTS

232 Providence Hwy.  
Westwood, MA 02090  
(617) 461-9754

## MICHIGAN

37454 Ann Arbor Trail  
Livonia, MI 48150  
(313) 432-1012

## MINNESOTA

6427 Penn Ave. South  
Richfield, MN 55423  
(612) 869-5199

## MISSOURI

9876 Watson Road  
St. Louis, MO 63126-2221  
(314) 909-9889

## NEBRASKA

4129 S. 84th St.  
Omaha, NE 68127  
(402) 597-2925

## NEVADA

3375 S. Decatur Blvd.  
SuiteS 22 - 24  
Las Vegas, NV 89102  
(702) 368-4277

## NEW JERSEY

251 Herrod Blvd.  
Dayton, NJ 08810-1539  
(609) 655-1212

## NEW MEXICO

5805 Menaul Blvd. NE  
Albuquerque, NM 87110  
(505) 881-4619

## NEW YORK

4917 Genessee Street  
Cheektowaga, NY 14225  
(716) 685-9503

131-35 31st Ave.  
Flushing, NY 11354  
(718) 866-0971

## NORTH CAROLINA

3501-G S. Tryon St.  
Charlotte, NC 28217  
(704) 527-0611

## OHIO

6253 E. Main St.  
Columbus, OH 43213  
(614) 860-0222

6379 Pearl Road  
Parma Heights, OH 44130  
(440) 843-7555

1617 E. Kemper Rd.  
Sharonville, OH 45246  
(513) 771-0788

## OKLAHOMA

552 E. Memorial Road  
Oklahoma City, OK 73114  
(405) 252-2655

## OREGON

828 19th Avenue., N.W.  
Portland, OR 97209  
(503) 222-1823

## PENNSYLVANIA

Springwater Plaza  
364 Wilmington W. Chester  
Pike  
Glen Mills, PA 19342  
(610) 459-4122

6200 Babcock Blvd  
Pittsburgh, PA 15237  
(412) 366-6363

## PUERTO RICO

200 Guayama St.  
Hato Rey, PR 00917  
(787) 250-8776

## TENNESSEE

4655 Nolensville Rd.  
Nashville, TN 37211  
(615) 331-9922

## TEXAS

4655 Nolensville Rd.  
Farmers Branch, TX 75234  
(972) 243-1150

12701 Directors Dr.  
Stafford, TX 77477-3701  
(281) 955-8665

3453 IH-35 North, Ste. 101  
San Antonio, TX 78219  
(210) 228-0676

## UTAH

145 E. 1300 S., Ste. 101  
Salt Lake City, UT 84115  
(801) 359-3410

## VIRGINIA

5760 Northampton Blvd., Ste.  
102  
Virginia Beach, VA 23455  
(757) 460-0280

## WASHINGTON

22220 84th Ave. So., Bldg. A  
Kent, WA 98032  
(253) 395-8055

## WISCONSIN

Lincoln Plaza Shopping Ctr.  
2245 S. 108th St. West Allis, WI  
53227  
(414) 541-4776

## CUSTOMER'S RECORD

<p><b>When you need service:</b> Send complete tool (prepaid) to one of the Makita Factory Service Centers listed, or to an Authorized Makita Service Center. Be sure to attach a letter to the outside of the carton detailing the problem with your tool.</p>	Date Purchased
	Dealer's Name & Address
	Model No.
	Serial No.

# WARNING

Some dust created by power sanding, sawing, grinding, drilling, and other construction activities contains chemicals known to the State of California to cause cancer, birth defects or other reproductive harm. Some examples of these chemicals are:

- lead from lead-based paints,
- crystalline silica from bricks and cement and other masonry products, and
- arsenic and chromium from chemically-treated lumber.

Your risk from these exposures varies, depending on how often you do this type of work. To reduce your exposure to these chemicals: work in a well ventilated area, and work with approved safety equipment, such as those dust masks that are specially designed to filter out microscopic particles.

## MAKITA LIMITED ONE YEAR WARRANTY

### Warranty Policy

Every Makita tool is thoroughly inspected and tested before leaving the factory. It is warranted to be free of defects from workmanship and materials for the period of ONE YEAR from the date of original purchase. Should any trouble develop during this one-year period, return the COMPLETE tool, freight prepaid, to one of Makita's Factory or Authorized Service Centers. If inspection shows the trouble is caused by defective workmanship or material, Makita will repair (or at our option, replace) without charge.

This Warranty does not apply where:

- repairs have been made or attempted by others:
- repairs are required because of normal wear and tear:
- the tool has been abused, misused or improperly maintained:
- alterations have been made to the tool.

IN NO EVENT SHALL MAKITA BE LIABLE FOR ANY INDIRECT, INCIDENTAL OR CONSEQUENTIAL DAMAGES FROM THE SALE OR USE OF THE PRODUCT. THIS DISCLAIMER APPLIES BOTH DURING AND AFTER THE TERM OF THIS WARRANTY.

MAKITA DISCLAIMS LIABILITY FOR ANY IMPLIED WARRANTIES, INCLUDING IMPLIED WARRANTIES OF "MERCHANTABILITY" AND "FITNESS FOR A SPECIFIC PURPOSE," AFTER THE ONE-YEAR TERM OF THIS WARRANTY.

This Warranty gives you specific legal rights, and you may also have other rights which vary from state to state. Some states do not allow the exclusion or limitation of incidental or consequential damages, so the above limitation or exclusion may not apply to you. Some states do not allow limitation on how long an implied warranty lasts, so the above limitation may not apply to you.

**Makita Corporation**  
3-11-8, Sumiyoshi-cho,  
Anjo, Aichi 446-8502 Japan