

MAGNUM™ SG CONTROL MODULE

Safety Depends on You

Lincoln arc welding and cutting equipment is designed and built with safety in mind. However, your overall safety can be increased by proper installation ... and thoughtful operation on your part. **DO NOT INSTALL, OPERATE OR REPAIR THIS EQUIPMENT WITHOUT READING THIS MANUAL AND THE SAFETY PRECAUTIONS CONTAINED THROUGHOUT.** And, most importantly, think before you act and be careful.



Date of Purchase: _____

Serial Number: _____

Code Number: _____

Model: _____

Where Purchased: _____

OPERATOR'S MANUAL



• World's Leader in Welding and Cutting Products •

• Sales and Service through Subsidiaries and Distributors Worldwide •

Cleveland, Ohio 44117-1199 U.S.A. TEL: 216.481.8100 FAX: 216.486.1751 WEB SITE: www.lincolnelectric.com

SAFETY

WARNING

CALIFORNIA PROPOSITION 65 WARNINGS

Diesel engine exhaust and some of its constituents are known to the State of California to cause cancer, birth defects, and other reproductive harm.

The Above For Diesel Engines

The engine exhaust from this product contains chemicals known to the State of California to cause cancer, birth defects, or other reproductive harm.

The Above For Gasoline Engines

ARC WELDING CAN BE HAZARDOUS. PROTECT YOURSELF AND OTHERS FROM POSSIBLE SERIOUS INJURY OR DEATH. KEEP CHILDREN AWAY. PACEMAKER WEARERS SHOULD CONSULT WITH THEIR DOCTOR BEFORE OPERATING.

Read and understand the following safety highlights. For additional safety information, it is strongly recommended that you purchase a copy of "Safety in Welding & Cutting - ANSI Standard Z49.1" from the American Welding Society, P.O. Box 351040, Miami, Florida 33135 or CSA Standard W117.2-1974. A Free copy of "Arc Welding Safety" booklet E205 is available from the Lincoln Electric Company, 22801 St. Clair Avenue, Cleveland, Ohio 44117-1199.

BE SURE THAT ALL INSTALLATION, OPERATION, MAINTENANCE AND REPAIR PROCEDURES ARE PERFORMED ONLY BY QUALIFIED INDIVIDUALS.



FOR ENGINE powered equipment.

1.a. Turn the engine off before troubleshooting and maintenance work unless the maintenance work requires it to be running.



1.b. Operate engines in open, well-ventilated areas or vent the engine exhaust fumes outdoors.



1.c. Do not add the fuel near an open flame welding arc or when the engine is running. Stop the engine and allow it to cool before refueling to prevent spilled fuel from vaporizing on contact with hot engine parts and igniting. Do not spill fuel when filling tank. If fuel is spilled, wipe it up and do not start engine until fumes have been eliminated.

1.d. Keep all equipment safety guards, covers and devices in position and in good repair. Keep hands, hair, clothing and tools away from V-belts, gears, fans and all other moving parts when starting, operating or repairing equipment.

1.e. In some cases it may be necessary to remove safety guards to perform required maintenance. Remove guards only when necessary and replace them when the maintenance requiring their removal is complete. Always use the greatest care when working near moving parts.



1.f. Do not put your hands near the engine fan. Do not attempt to override the governor or idler by pushing on the throttle control rods while the engine is running.

1.g. To prevent accidentally starting gasoline engines while turning the engine or welding generator during maintenance work, disconnect the spark plug wires, distributor cap or magneto wire as appropriate.



1.h. To avoid scalding, do not remove the radiator pressure cap when the engine is hot.



ELECTRIC AND MAGNETIC FIELDS may be dangerous

2.a. Electric current flowing through any conductor causes localized Electric and Magnetic Fields (EMF). Welding current creates EMF fields around welding cables and welding machines

2.b. EMF fields may interfere with some pacemakers, and welders having a pacemaker should consult their physician before welding.

2.c. Exposure to EMF fields in welding may have other health effects which are now not known.

2.d. All welders should use the following procedures in order to minimize exposure to EMF fields from the welding circuit:

2.d.1. Route the electrode and work cables together - Secure them with tape when possible.

2.d.2. Never coil the electrode lead around your body.

2.d.3. Do not place your body between the electrode and work cables. If the electrode cable is on your right side, the work cable should also be on your right side.

2.d.4. Connect the work cable to the workpiece as close as possible to the area being welded.

2.d.5. Do not work next to welding power source.

Mar '95

SAFETY



ELECTRIC SHOCK can kill.

- 3.a. The electrode and work (or ground) circuits are electrically "hot" when the welder is on. Do not touch these "hot" parts with your bare skin or wet clothing. Wear dry, hole-free gloves to insulate hands.
- 3.b. Insulate yourself from work and ground using dry insulation. Make certain the insulation is large enough to cover your full area of physical contact with work and ground.

In addition to the normal safety precautions, if welding must be performed under electrically hazardous conditions (in damp locations or while wearing wet clothing; on metal structures such as floors, gratings or scaffolds; when in cramped positions such as sitting, kneeling or lying, if there is a high risk of unavoidable or accidental contact with the workpiece or ground) use the following equipment:

- Semiautomatic DC Constant Voltage (Wire) Welder.
- DC Manual (Stick) Welder.
- AC Welder with Reduced Voltage Control.

- 3.c. In semiautomatic or automatic wire welding, the electrode, electrode reel, welding head, nozzle or semiautomatic welding gun are also electrically "hot".
- 3.d. Always be sure the work cable makes a good electrical connection with the metal being welded. The connection should be as close as possible to the area being welded.
- 3.e. Ground the work or metal to be welded to a good electrical (earth) ground.
- 3.f. Maintain the electrode holder, work clamp, welding cable and welding machine in good, safe operating condition. Replace damaged insulation.
- 3.g. Never dip the electrode in water for cooling.
- 3.h. Never simultaneously touch electrically "hot" parts of electrode holders connected to two welders because voltage between the two can be the total of the open circuit voltage of both welders.
- 3.i. When working above floor level, use a safety belt to protect yourself from a fall should you get a shock.
- 3.j. Also see Items 6.c. and 8.



ARC RAYS can burn.

- 4.a. Use a shield with the proper filter and cover plates to protect your eyes from sparks and the rays of the arc when welding or observing open arc welding. Headshield and filter lens should conform to ANSI Z87.1 standards.
- 4.b. Use suitable clothing made from durable flame-resistant material to protect your skin and that of your helpers from the arc rays.
- 4.c. Protect other nearby personnel with suitable, non-flammable screening and/or warn them not to watch the arc nor expose themselves to the arc rays or to hot spatter or metal.



FUMES AND GASES can be dangerous.

- 5.a. Welding may produce fumes and gases hazardous to health. Avoid breathing these fumes and gases. When welding, keep your head out of the fume. Use enough ventilation and/or exhaust at the arc to keep fumes and gases away from the breathing zone. **When welding with electrodes which require special ventilation such as stainless or hard facing (see instructions on container or MSDS) or on lead or cadmium plated steel and other metals or coatings which produce highly toxic fumes, keep exposure as low as possible and below Threshold Limit Values (TLV) using local exhaust or mechanical ventilation. In confined spaces or in some circumstances, outdoors, a respirator may be required. Additional precautions are also required when welding on galvanized steel.**
- 5.b. Do not weld in locations near chlorinated hydrocarbon vapors coming from degreasing, cleaning or spraying operations. The heat and rays of the arc can react with solvent vapors to form phosgene, a highly toxic gas, and other irritating products.
- 5.c. Shielding gases used for arc welding can displace air and cause injury or death. Always use enough ventilation, especially in confined areas, to insure breathing air is safe.
- 5.d. Read and understand the manufacturer's instructions for this equipment and the consumables to be used, including the material safety data sheet (MSDS) and follow your employer's safety practices. MSDS forms are available from your welding distributor or from the manufacturer.
- 5.e. Also see item 1.b.

Mar '95

SAFETY

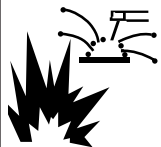

WELDING SPARKS can cause fire or explosion.

6.a. Remove fire hazards from the welding area. If this is not possible, cover them to prevent the welding sparks from starting a fire.

Remember that welding sparks and hot materials from welding can easily go through small cracks and openings to adjacent areas. Avoid welding near hydraulic lines. Have a fire extinguisher readily available.

6.b. Where compressed gases are to be used at the job site, special precautions should be used to prevent hazardous situations. Refer to "Safety in Welding and Cutting" (ANSI Standard Z49.1) and the operating information for the equipment being used.

6.c. When not welding, make certain no part of the electrode circuit is touching the work or ground. Accidental contact can cause overheating and create a fire hazard.

6.d. Do not heat, cut or weld tanks, drums or containers until the proper steps have been taken to insure that such procedures will not cause flammable or toxic vapors from substances inside. They can cause an explosion even though they have been "cleaned". For information, purchase "Recommended Safe Practices for the Preparation for Welding and Cutting of Containers and Piping That Have Held Hazardous Substances", AWS F4.1 from the American Welding Society (see address above).

6.e. Vent hollow castings or containers before heating, cutting or welding. They may explode.

6.f. Sparks and spatter are thrown from the welding arc. Wear oil free protective garments such as leather gloves, heavy shirt, cuffless trousers, high shoes and a cap over your hair. Wear ear plugs when welding out of position or in confined places. Always wear safety glasses with side shields when in a welding area.

6.g. Connect the work cable to the work as close to the welding area as practical. Work cables connected to the building framework or other locations away from the welding area increase the possibility of the welding current passing through lifting chains, crane cables or other alternate circuits. This can create fire hazards or overheat lifting chains or cables until they fail.

6.h. Also see item 1.c.



CYLINDER may explode if damaged.

7.a. Use only compressed gas cylinders containing the correct shielding gas for the process used and properly operating regulators designed for the gas and pressure used. All hoses, fittings, etc. should be suitable for the application and maintained in good condition.

7.b. Always keep cylinders in an upright position securely chained to an undercarriage or fixed support.

7.c. Cylinders should be located:
• Away from areas where they may be struck or subjected to physical damage.

• A safe distance from arc welding or cutting operations and any other source of heat, sparks, or flame.

7.d. Never allow the electrode, electrode holder or any other electrically "hot" parts to touch a cylinder.

7.e. Keep your head and face away from the cylinder valve outlet when opening the cylinder valve.

7.f. Valve protection caps should always be in place and hand tight except when the cylinder is in use or connected for use.

7.g. Read and follow the instructions on compressed gas cylinders, associated equipment, and CGA publication P-1, "Precautions for Safe Handling of Compressed Gases in Cylinders," available from the Compressed Gas Association 1235 Jefferson Davis Highway, Arlington, VA 22202.



FOR ELECTRICALLY powered equipment.

8.a. Turn off input power using the disconnect switch at the fuse box before working on the equipment.

8.b. Install equipment in accordance with the U.S. National Electrical Code, all local codes and the manufacturer's recommendations.

8.c. Ground the equipment in accordance with the U.S. National Electrical Code and the manufacturer's recommendations.

Mar '95

PRÉCAUTIONS DE SÛRETÉ

Pour votre propre protection lire et observer toutes les instructions et les précautions de sûreté spécifiques qui paraissent dans ce manuel aussi bien que les précautions de sûreté générales suivantes:

Sûreté Pour Soudage A L'Arc

1. Protégez-vous contre la secousse électrique:
 - a. Les circuits à l'électrode et à la pièce sont sous tension quand la machine à souder est en marche. Eviter toujours tout contact entre les parties sous tension et la peau nue ou les vêtements mouillés. Porter des gants secs et sans trous pour isoler les mains.
 - b. Faire très attention de bien s'isoler de la masse quand on soude dans des endroits humides, ou sur un plancher métallique ou des grilles métalliques, principalement dans les positions assis ou couché pour lesquelles une grande partie du corps peut être en contact avec la masse.
 - c. Maintenir le porte-électrode, la pince de masse, le câble de soudage et la machine à souder en bon et sûr état de fonctionnement.
 - d. Ne jamais plonger le porte-électrode dans l'eau pour le refroidir.
 - e. Ne jamais toucher simultanément les parties sous tension des porte-électrodes connectés à deux machines à souder parce que la tension entre les deux pinces peut être le total de la tension à vide des deux machines.
 - f. Si on utilise la machine à souder comme une source de courant pour soudage semi-automatique, ces précautions pour le porte-électrode s'appliquent aussi au pistolet de soudage.
2. Dans le cas de travail au dessus du niveau du sol, se protéger contre les chutes dans le cas où on reçoit un choc. Ne jamais enrouler le câble-électrode autour de n'importe quelle partie du corps.
3. Un coup d'arc peut être plus sévère qu'un coup de soleil, donc:
 - a. Utiliser un bon masque avec un verre filtrant approprié ainsi qu'un verre blanc afin de se protéger les yeux du rayonnement de l'arc et des projections quand on soude ou quand on regarde l'arc.
 - b. Porter des vêtements convenables afin de protéger la peau de soudeur et des aides contre le rayonnement de l'arc.
 - c. Protéger l'autre personnel travaillant à proximité au soudage à l'aide d'écrans appropriés et non-inflammables.
4. Des gouttes de laitier en fusion sont émises de l'arc de soudage. Se protéger avec des vêtements de protection libres de l'huile, tels que les gants en cuir, chemise épaisse, pantalons sans revers, et chaussures montantes.
5. Toujours porter des lunettes de sécurité dans la zone de soudage. Utiliser des lunettes avec écrans latéraux dans les

zones où l'on pique le laitier.

6. Eloigner les matériaux inflammables ou les recouvrir afin de prévenir tout risque d'incendie dû aux étincelles.
7. Quand on ne soude pas, poser la pince à un endroit isolé de la masse. Un court-circuit accidentel peut provoquer un échauffement et un risque d'incendie.
8. S'assurer que la masse est connectée le plus près possible de la zone de travail qu'il est pratique de le faire. Si on place la masse sur la charpente de la construction ou d'autres endroits éloignés de la zone de travail, on augmente le risque de voir passer le courant de soudage par les chaînes de levage, câbles de grue, ou autres circuits. Cela peut provoquer des risques d'incendie ou d'échauffement des chaînes et des câbles jusqu'à ce qu'ils se rompent.
9. Assurer une ventilation suffisante dans la zone de soudage. Ceci est particulièrement important pour le soudage de tôles galvanisées plombées, ou cadmiées ou tout autre métal qui produit des fumées toxiques.
10. Ne pas souder en présence de vapeurs de chlore provenant d'opérations de dégraissage, nettoyage ou pistelage. La chaleur ou les rayons de l'arc peuvent réagir avec les vapeurs du solvant pour produire du phosgène (gas fortement toxique) ou autres produits irritants.
11. Pour obtenir de plus amples renseignements sur la sûreté, voir le code "Code for safety in welding and cutting" CSA Standard W 117.2-1974.

PRÉCAUTIONS DE SÛRETÉ POUR LES MACHINES À SOUDER À TRANSFORMATEUR ET À REDRESSEUR

1. Relier à la terre le châssis du poste conformément au code de l'électricité et aux recommandations du fabricant. Le dispositif de montage ou la pièce à souder doit être branché à une bonne mise à la terre.
2. Autant que possible, l'installation et l'entretien du poste seront effectués par un électricien qualifié.
3. Avant de faire des travaux à l'intérieur de poste, la débrancher à l'interrupteur à la boîte de fusibles.
4. Garder tous les couvercles et dispositifs de sûreté à leur place.

Mar. '93

Thank You

for selecting a **QUALITY** product by Lincoln Electric. We want you to take pride in operating this Lincoln Electric Company product
•• as much pride as we have in bringing this product to you!

Please Examine Carton and Equipment For Damage Immediately

When this equipment is shipped, title passes to the purchaser upon receipt by the carrier. Consequently, Claims for material damaged in shipment must be made by the purchaser against the transportation company at the time the shipment is received.

Please record your equipment identification information below for future reference. This information can be found on your machine nameplate.

Model Name & Number _____

Code & Serial Number _____

Date of Purchase _____

Whenever you request replacement parts for or information on this equipment always supply the information you have recorded above.

Read this Operators Manual completely before attempting to use this equipment. Save this manual and keep it handy for quick reference. Pay particular attention to the safety instructions we have provided for your protection. The level of seriousness to be applied to each is explained below:

⚠ WARNING

This statement appears where the information **must** be followed **exactly** to avoid **serious personal injury** or **loss of life**.

⚠ CAUTION

This statement appears where the information **must** be followed to avoid **minor personal injury** or **damage to this equipment**.

TABLE OF CONTENTS

	Page
SAFETY PRECAUTIONS	2-5
PRODUCT DESCRIPTION	8
SPECIFICATIONS	8
REQUIRED EQUIPMENT	8
OPTIONAL ACCESSORIES	8-10
INSTALLATION	11
Safety Precautions	11
Unpacking the Control Module	11
Control Module Familiarization	11
Connection to Power Source	12
Installation of K492-10 Input Cable to Power Sources with a Terminal Strip	12
Installation of K493-10 Input Cable to Power Sources with a 14-pin Connector	12
Installation of K691-10 Input Cable with 14-Pin Connector to 115V Plug	13
Setting the Mode Switch on Rear Panel	13
Connection to Spool Gun	14
Work Lead Connection	13
OPERATING INSTRUCTIONS	15
Safety Precautions	15
Initial Checkout of Magnum SG System Installation	15
Setting Gas Flow Rate on Gas Cylinder Regulator	16
Setting Gas Preflow Time on Control Module	16
Setting the Wire Speed	16
Setting Wire Speed When Using a K469 Spool Gun	16
Setting Wire Speed When Using a K487 Spool Gun Having Remote Speed Control	16
Making a Weld	16
MAINTENANCE	16
Safety Precautions	16
Routine Maintenance	16
WIRING DIAGRAM	17
PARTS LIST	P198 Series

Product Description

The Magnum SG Control Module is an interface between the welding power source and the Magnum Spool Gun. The Control Module and Spool Gun combination provide a system for welding primarily with aluminum electrode wire using a constant voltage welding power source.

The Control Module provides control of both wire speed and gas flow. It also provides connections from the welding power cable, control cable, and gas hose from the power source and gas cylinder regulator to the spool gun.

The Control Module will operate with any power source that provides constant voltage welding output and has an output contactor.

Required Equipment

To operate the Magnum SG Control Module, the following equipment is required and ordered separately:

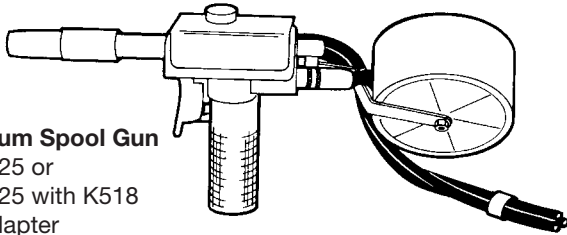

Magnum Spool Gun
K487-25 or
K469-25 with K518
Adapter

Power Source

The Control Module will operate with any Lincoln CV or CV/CC power sources, with many Lincoln engine-driven welders (see the complete list at the end of this section), and with many non-Lincoln type power sources.

In general, power sources must have the following:

1. A constant voltage (CV) type welding output.
2. Capability to supply 115 volt AC power to the control module.
3. Optional for “cold electrode” switched welding output: An output contactor. It can be either of two types:
 - A. Switch closure: Internally-energized type actuated by an external switch.
 - B. 115 VAC: Externally-energized type actuated by 115 volts AC supplied from the control module to the power source.

A selector switch on the back of the control module is used to select which of these two types of control circuit is being used. It is imperative that this switch be set correctly before attaching to the power source. See “Setting the Mode Switch on Rear Panel” for more details.

The control module is not required when connecting Magnum spool guns to Lincoln models SP-150 or SP-200, which have built-in wire feed control circuits. In addition, the Lincoln models SP-250, SP-255, Wire-Matic 250, Wire-Matic 255 do not require the control module when the optional K607-1 or K672-1 Spool Gun Adapter kit is installed, since these kits also provide wire feed control circuits.

Specifications

Model:	Magnum SG Control Module
Type:	K488
Power Requirements: Voltage	115 VAC, 50/60 Hz
Current	0.5 amps maximum
Welding Current Rating:	250 amps at 60% duty cycle
Motor Output:	5-28 VDC
Preflow Time:	0-1 second
Contacting Circuit Output:	Normally open relay contacts (“Closure”) or 115 VAC; selectable
Dimensions, H* x W x D	10.0 x 8.25 x 9.0 inches
*dimension includes handle	(254 x 210 x 229mm)
Weight	13 Lbs. (5.9kg)

Optional Accessories

Several accessories are optionally available for use with the K488 control module, and they are as follows:

1. Three 10 ft. (3.0m) input cable assemblies are available and consist of control and electrode cables and gas line. The proper input cable assembly must be ordered in addition to the control module; as none are included with the control module:
 - A. K492-10 for use with Lincoln CV power sources having terminal strip control connections (Lincoln R3S, CV-400, and DC family machines). Can also be used with non-Lincoln CV power sources.
 - B. K493-10 for use with Lincoln CV power sources having 14-pin control cable connection (Lincoln CV and CV-I series, Invertec V-200).
 - C. K691-10 for use with Lincoln engine-driven power sources having 14-pin control cable connection and/or 115VAC outlet.
2. K473 Spool Gun Extension Cable. 25’ extension cable extends distance between spool gun and K488 control module.
3. K518 Adapter for K469 Spool Gun. Adapts K469 spool gun to K488 Control Module or to K473 Extension Cable.

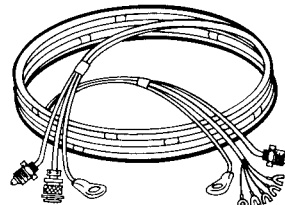

K492-10

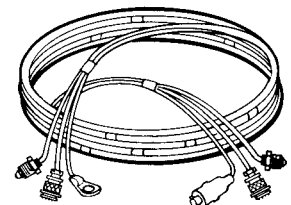

K493-10

For convenience, here is a summary of needed equipment to use the various combinations of available Magnum spool guns and accessories:

ACCESSORIES

For Static (Transformer Type) Power Sources

Power Source	SP-150	SP-200	SP-250/SP 250-I & Wire-Matic 250	SP-255/SP 255-I & Wire-Matic 255	CV Output Machine with Contactor
Spool Gun					
K469-25	None required	None required	K518 Adapter K607-1 Spool Gun Adapter Kit	K518 Adapter K672-1 Spool Gun Adapter Kit	K518 Adapter K488 Control Module K492-10 Input Cable for machines with terminal strip -OR- K493-10 Input Cable for Lincoln machines with 14-pin connector
K469-25 with K473 Extension Cable	K518 Adapter K516 Adapter	K518 Adapter K517 Adapter	K518 Adapter K607-1 Spool Gun Adapter Kit (K473 requires minor modification)	K518 Adapter K672-1 Spool Gun Adapter Kit	same as above
K487-25	K516 Adapter (No remote WFS control)	K517 Adapter (No remote WFS control)	K607-1 Spool Gun Adapter Kit	K672-1 Spool Gun Adapter Kit	K488 Control Module K492-10 Input Cable for machines with terminal strip -OR- K493-10 Input Cable for Lincoln machines with 14-pin connector
K487-25 with K473 Extension Cable	K516 Adapter (No remote WFS control)	K517 Adapter (No remote WFS control)	K607-1 Spool Gun Adapter Kit (K473 requires minor modification)	K672-1 Spool Gun Adapter Kit	same as above

ACCESSORIES

For Rotating (Engine-Driven Type) Power Sources:

Machine*	14-pin Amphenol connector?	Terminal Strip (2,4,31,32)	Internal Contactor?	115V AC Outlet?	Recommended Input Cable Assembly	Cold Electrode?
Classic II	N	N	N	Y	K691-10	N
Classic II w/Wire Feeder Module	Y	N	Y	Y	K691-10	Y
Classic III	N	N	N	Y	K691-10	N
Classic III w/Wire Feed Module	Y	N	Y	Y	K691-10	Y
Classic IIID	N	N	N	Y	K691-10	N
Classic IIID w/Wire Feed Module	Y	N	Y	Y	K691-10	Y
Commander 300	Y	N	Y	Y	K691-10	Y
Commander 400 (Stick)	N	N	N	Y	K691-10	N
Commander 400 (Stick & Wire)	Y	N	Y	Y	K691-10	Y
Ranger 10	N	N	N	Y	K691-10	N
Ranger 10LX (Incl. CSA)	Y	N	Y	Y	K691-10	Y
Ranger 275	Y	N	Y	Y	K691-10	Y
Ranger 300D	N	N	N	Y	K691-10	N
Ranger 300DLX	Y	N	Y	Y	K691-10	Y
Ranger 8 (Incl. CSA & LPG)	N	N	N	Y	K691-10	N
Ranger 9 (Incl. CSA)	Y	N	Y	Y	K691-10	Y
SA-250	N	N	N	Y	K691-10	N
SA-250 w/CV Adapter	N	N	N	Y	K691-10	N
SA-250 w/Wire Feed Module	Y	N	Y	Y	K691-10	Y
350-SA	N	N	N	Y	K691-10	N
350-SA w/Wire Feed Module	Y	N	Y	Y	K691-10	Y
SAE-350 w/CV Adapter	N	N	N	Y	K691-10	N
SAE-400 w/CV Adapter	N	N	N	Y	K691-10	N
SAE-400 WELD 'N AIR w/CV Adapter	N	N	N	Y	K691-10	N
SAM-400	N	Y	Y	Y	K492-10	Y
450 SAE w/CV Adapter	N	N	N	Y	K691-10	N
SAM-650	N	Y	Y	Y	K492-10	Y
Weldanpower 150 AC/DC	N	N	N	Y	K691-10	N
Weldanpower 225 G7	N	N	N	Y	K691-10	N
Weldanpower 250 D10	N	N	N	Y	K691-10	N
Weldanpower 250 D10 PRO	N	Y	Y	Y	K492-10	Y
Weldanpower 250 G9 PRO	N	Y	Y	Y	K492-10	Y
Weldanpower G8000	N	N	N	Y	K691-10	N

* For non-Lincoln equipment having a terminal strip and either switch closure or 115VAC activated output contactor (if present), use K492-10.

INSTALLATION

Safety Precautions

	WARNING
	ELECTRIC SHOCK can kill

- Have an electrician install and service this equipment.
- Turn the input power off at the fuse box before working on equipment.
- Do not touch electrically hot parts.

Read “Arc Welding Safety Precautions” in the Operating Manual before proceeding. Only personnel that have read and understood the Operating Manual should install and operate this equipment.

Power source must be connected to system ground per the U.S. National Electrical Code and any applicable local codes.

Unpacking The SG Control Module

Carefully unpack the Control Module and make sure you have the following contents:

Control Module

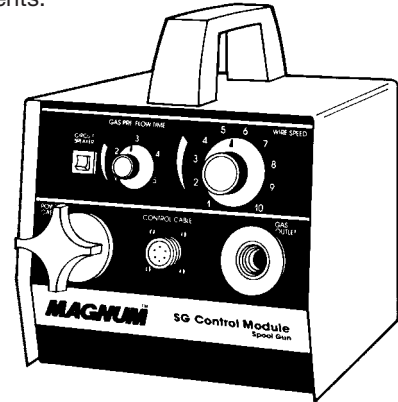

Operating Manual

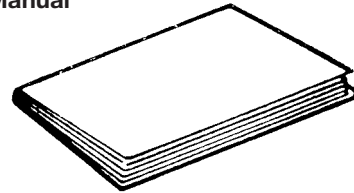

Control Module Familiarization

Become familiar with the various controls and connectors on the Control Module before connecting to power source. Refer to illustrations and numbered items below for brief description.

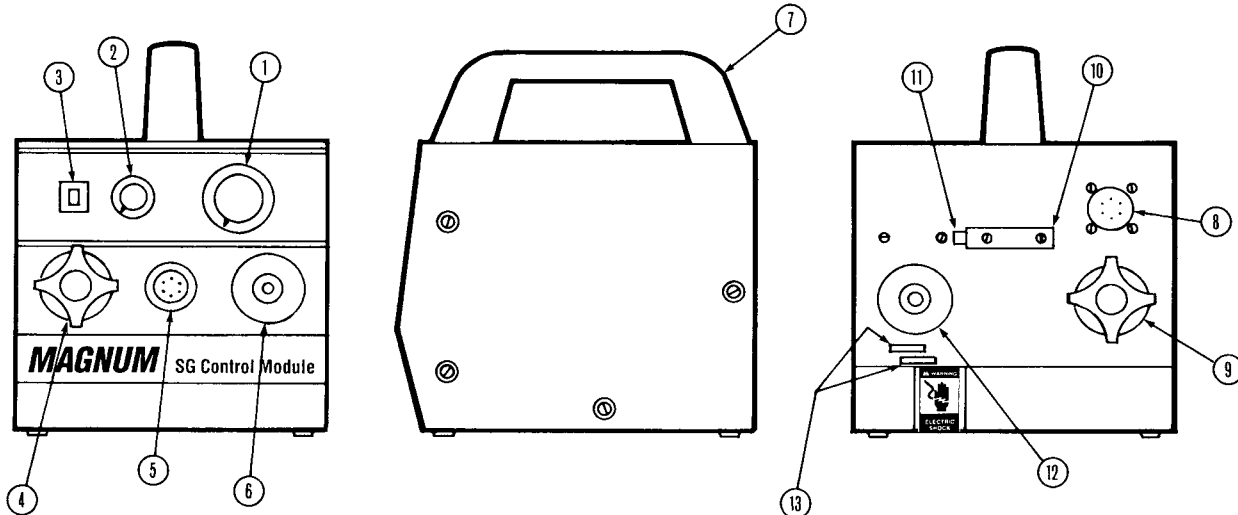

1. Wire speed control potentiometer for varying wire feed speed
2. Preflow timer (0-1 second) adjusts wire feeder start-up delay time from when gas flow starts
3. 2A circuit breaker, manual reset; protects control circuitry
4. Output connector for spool gun electrode cable
5. Connector for spool gun control cable
6. Gas fitting for spool gun gas line
7. Carrying handle
8. Connector for input cable assembly control cable to power source
9. Input connector for input cable assembly electrode cable
10. Lockout bar for mode switch
11. Mode switch for selecting type of contactor circuit in power source
12. Gas fitting for input cable assembly gas line
13. Control Module code and serial numbers

INSTALLATION

to Power Source

Connect the control module to the power source using either a K492-10, K493-10 or K691-10 Input Cable Assembly (ordered separately), and follow the simple steps below.

Installation of K492-10 Input Cable to Power Sources with a Terminal Strip

1. Identify the cable end which has the Amphenol connector associated with it. This end attaches to the Control Module.

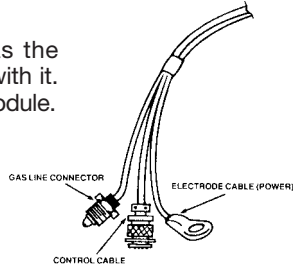

2. Attach the control cable Amphenol connector, gas line connector, and electrode cable terminal to their respective connectors on the rear panel of the Control Module.

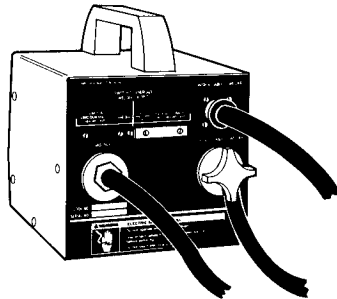

3. At the other end of the cable:

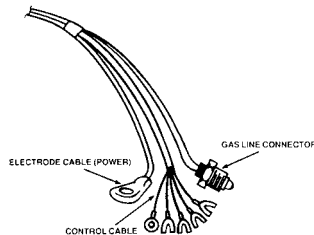

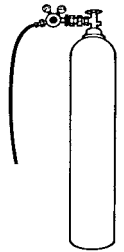

Connection

Connect the gas line to the gas cylinder regulator

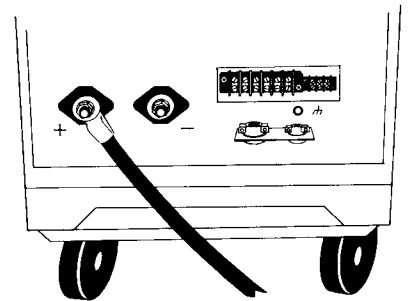

4. Connect the electrode cable to the positive(+) output stud on the power source.



5. Locate and open the access panel for the terminal strip on the power source and connect the control cable:
 - a. Connect the terminal on the green-lead (marked "GND") to the ground screw () on the chassis panel or terminal strip.
 - b. Connect the white- and black-lead terminals marked "31" and "32" to the corresponding 115 VAC terminals on the terminal strip.
 - c. Connect the remaining two leads marked "2" and "4" to the corresponding terminals which activate the output contactor whether it be by switch closure or 115 VAC supplied to the power source from the Control Module.

6. Set mode switch on back of the Control Module for the type of contactor circuit in the power source being used. See "Setting the Mode Switch on Rear Panel".

WARNING: Improper switch position may result in equipment damage.

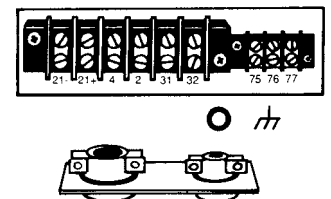

Installation of K493-10 Input Cable to Power Sources with a 14-pin Connector

1. Identify the cable end which has a lug on the end of the electrode cable. This end attaches to the Control Module.

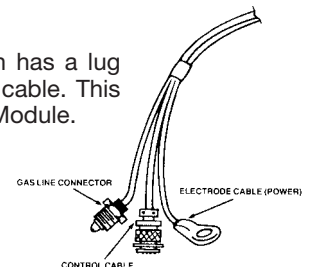

INSTALLATION

2. Attach the control cable Amphenol, gas line connector, and electrode cable terminal to their respective connectors on the rear panel of the Control Module.

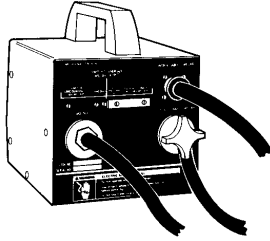

2. Connect the gas line to the gas cylinder regulator, connect the electrode cable to the positive (+) output stud on the power source, connect the control cable to the 14-pin Amphenol connector on the power source (if present), and plug the 115V plug into the outlet for 115V auxiliary power.

3. At the other end of the cable:

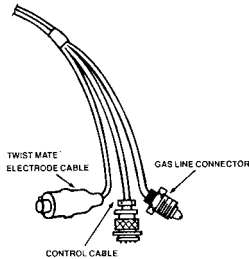

Make appropriate power source connections

and

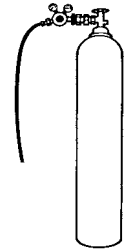

3. At the other end of the cable, attach the control cable Amphenol connector, gas line connector, and electrode cable terminal to their respective connectors on the rear panel of the control module.

Connect the gas line to the gas cylinder regulator

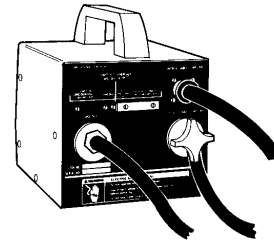
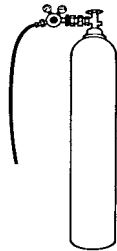

4. Connect the Twist-Mate™ plug on the electrode cable to the positive (+) polarity mating plug on the power source.

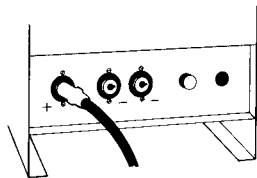

5. Connect the 14-pin Amphenol connector to the mating connector on the power source.

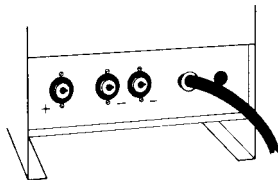

6. Set the Mode Switch on back of the Control Module for the type of contactor circuit in the power source being used. See "Setting the Mode Switch on Rear Panel". **WARNING:** Improper switch position may result in equipment damage.

4. Set the Mode Switch on back of the Control Module for the type of contactor circuit in the power source being used. See "Setting the Mode Switch on Rear Panel". **WARNING:** Improper switch position may result in equipment damage.

Setting the Mode Switch on Rear Panel

The slide switch on the rear panel selects between power sources whose output contactors are either internally energized or externally energized from 115 VAC. The Control Module is shipped with the mode switch in the left switch position and is for power sources requiring only circuit closure (i.e., continuity) to energize the output contactor. Lincoln machines are of this type. Right switch position is for power sources requiring that 115 VAC be supplied to the contactor.

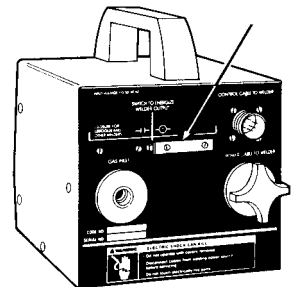

Installation of K691-10 Input Cable to Power Sources with a 14-pin Connector

1. Identify the cable end which has a 115V cordset with plug attached to the Amphenol connector. This end attaches to the engine-driven power source.

INSTALLATION

When connecting the Control Module to a non-Lincoln power source, determine which type of output contactor your power source has. If the switch is not in the correct position, remove the single screw securing the lockout bar and remove. Slide the switch to the correct position and reinstall lockout bar on other side using screw already in place there. Replace first screw in original location.

CAUTION: Be sure that mode switch is in correct position before attempting to operate control module. Incorrect switch position could result in damage to the control module and/or power source. Consult your power source instruction manual to see what type of output contactor circuit it has. Be sure to reinstall lockout bar if switch position is altered.

Work Lead Connection

Connect the work lead to the negative (-) polarity output stud or connector on the power source. Make sure the lead is of sufficient length and gauge for your setup per standard welding practice.

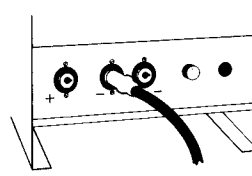

Connection to 487-25 Spool Gun

Connect the electrode cable, gas line, and control cable of the spool gun to their respective connectors on the front of the Control Module.

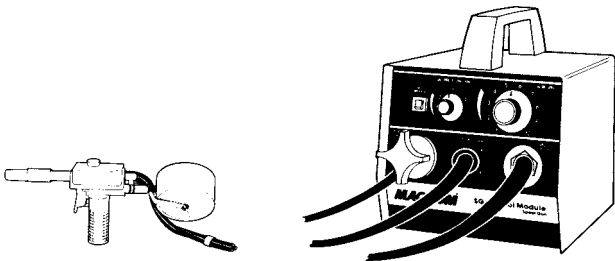

Connection to 469-25 Spool Gun*

1. Connect K518 adapter to spool gun control cable.

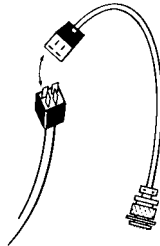

2. Connect the electrode cable, gas line, and control cable of the spool gun to their respective connectors on the front of the Control Module.

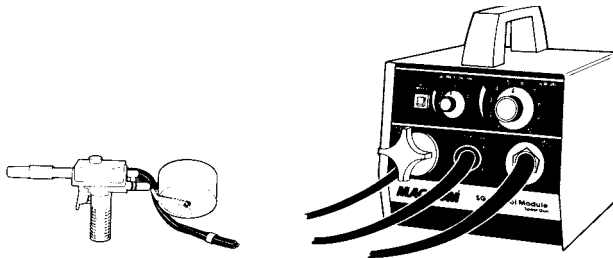





*Requires K518 adapter (ordered separately)



OPERATION

Safety Precautions

 WARNING	
	<ul style="list-style-type: none">• Do not touch electrically live parts or electrode with skin or wet clothing.• Insulate yourself from work and ground.
ELECTRIC SHOCK can kill	
	<ul style="list-style-type: none">• Keep your head out of fumes.• Use ventilation or exhaust to remove fumes from breathing zone.
FUMES AND GASES can be dangerous.	
	<ul style="list-style-type: none">• Keep flammable material away.
WELDING SPARKS can cause fire or explosion.	
	<ul style="list-style-type: none">• Wear eye, ear and body protection.
ARC RAYS can burn.	

Initial Checkout of Magnum SG System Installation

If all of the following steps check okay, then your system is correctly installed and operational.

1. Inspect all cables and connectors for missing or incorrect connections.

In particular, ensure that ground lead is correctly attached to chassis ground inside welder with terminal strip control connections.
2. Open gas cylinder valve and adjust regulator.
3. Set power source to minimum tap or output setting.
4. Set power source mode switch for CV output, if applicable.
5. Remove idle roll pressure in spool gun by pushing release lever up so that it will not feed wire.
6. Apply power to power source.
7. Pick up spool gun and squeeze spool gun trigger. Solenoid valve in Control Module should energize. Gas should be heard flowing from cone of spool gun. Drive roll in spool gun should rotate clockwise.
8. Rotate wire speed control knob on Module from minimum to maximum with trigger pressed and verify that drive roll speed increases significantly.
9. For K847 spool gun only, rotate speed control in handle and verify that speed varies between 0 and 100% of setting on Control Module.
10. Release trigger. Gas flow should be heard to stop.
11. Set preflow time on Control Module to minimum and press trigger. Drive roll should start rotating after approximately 1 second.
12. Turn preflow control on Control Module to minimum and squeeze trigger. Drive roll should start rotating immediately. Release trigger.
13. Verify that the output contactor in power source is operational with the spool gun by pressing the trigger. On some machines the contactor will be audible; on others it may be silent.

Observe that voltage is present (observed with power sources equipped with a voltmeter).

OPERATION

Setting Gas Flow Rate on Gas Cylinder Regulator

Gas handling systems having adjustable flow valves should be set per the information in the spool gun operating manual. A typical value is 30 cubic feet per hour (cfh), or 14 liters per minute.

Setting Gas Preflow Time on Control Module

Set the preflow to achieve good bead appearance at the start of the bead. A contaminated appearance at the start of the bead probably indicates a longer preflow time is needed.

Setting the Wire Speed

Set the wire speed, per the instructions in sections 1 and 2 below, to obtain the wire speed specified in the procedure settings given in the spool gun manual. Measure the wire speed with a wire speed meter or drive roll tachometer, if available. Alternatively, the wire speed can be set by adjusting until the welding current per desired welding procedure is achieved.

Setting Wire Speed When Using a K469 Spool Gun

The wire speed control knob on the Control Module varies the wire speed from approximately 50 to 650 ipm (1.3 to 16.5 m/min.). Use this control to set the desired wire feed speed.

Setting Wire Speed When Using a K487 Spool Gun Having Remote Speed Control

Set the wire speed control knob on the Control Module to maximum. The control in the handle of the spool gun now varies the wire speed across the entire range [approximately 50 to 650 ipm (1.3 to 16.5m/min.)]. In general, the spool gun potentiometer varies the speed between 0 and 100% of the Control Module wire speed control setting. A good practice is to set the Control Module speed potentiometer for the maximum anticipated wire speed needed so that the control in the handle of the spool gun gives good range control. Alternatively, the spool gun handle potentiometer can be set to maximum and the Control Module potentiometer used as a conventional speed control.

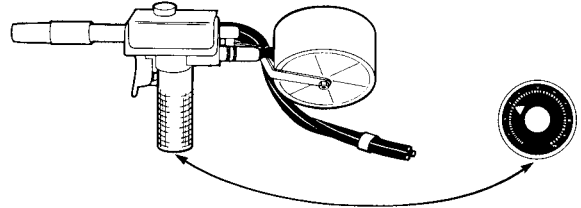



Making a Weld

Refer to your spool gun operating manual for instructions for welding.

MAINTENANCE

Safety Precautions

	WARNING
	<ul style="list-style-type: none">• Do not operate with covers removed.• Disconnect input power from power source before servicing control module.• Do not touch electrically live parts.
ELECTRIC SHOCK can kill	

Routine Maintenance

The Control Module is designed to give years of trouble-free service with little maintenance.

Recommended maintenance is limited to keeping the case and cables clean. Use a damp rag to wipe down the case parts and cables. Mild detergent can also be used, but do not use solvent-based cleaners on nameplate, plastic parts, or cables. Any questionable cleaner should be tried first on an inconspicuous place on the machine.

DIAGRAMS

Wiring Diagram

NOTE: This diagram is for reference only. It is not accurate for all machines covered by this manual. The specific diagram for a particular code is pasted inside the machine on one of the enclosure panels. If the diagram is illegible, write to the Service Department for a replacement. Give the welder code number.

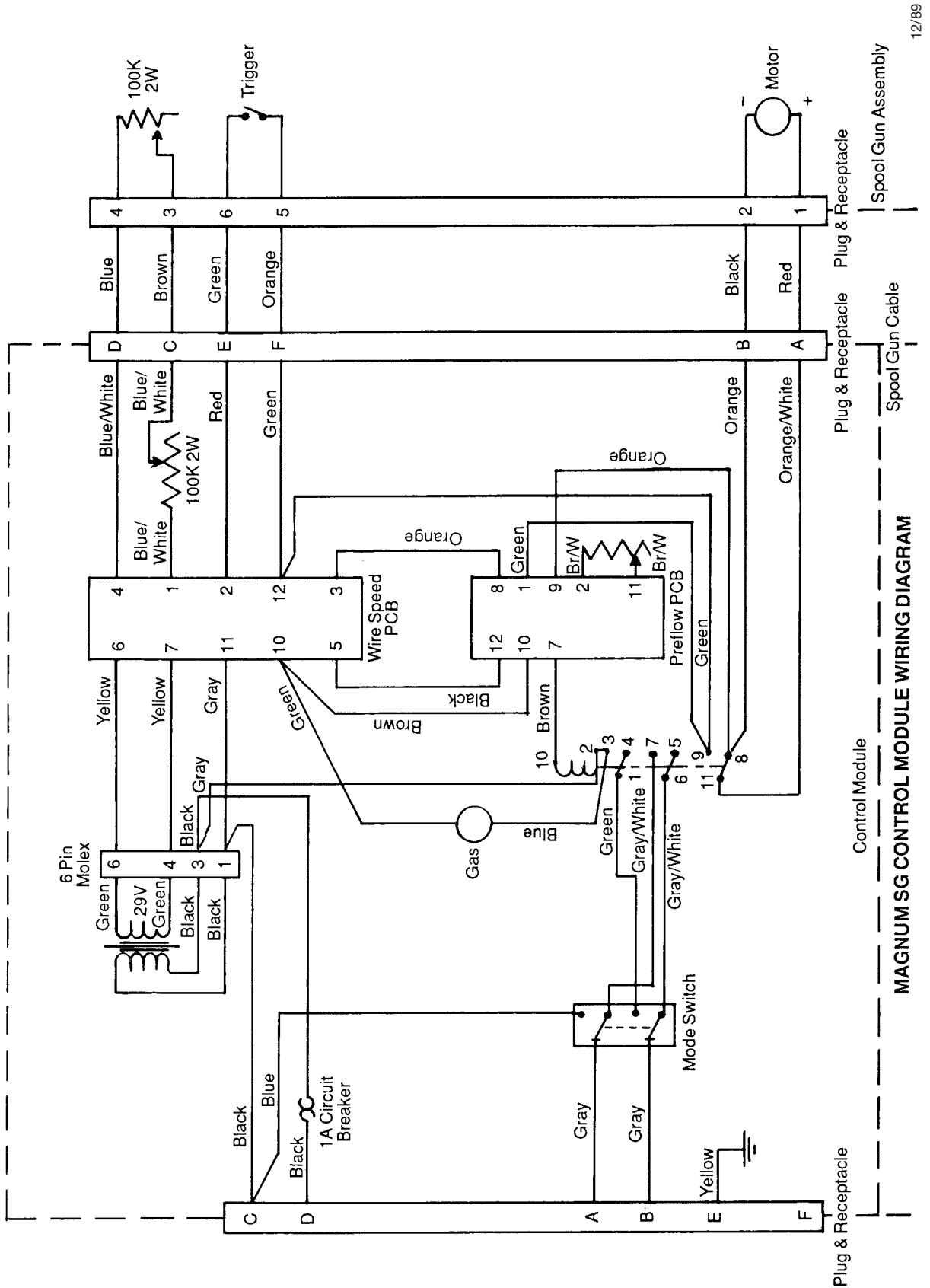

12/89

NOTES

WARNING	<ul style="list-style-type: none"> ● Do not touch electrically live parts or electrode with skin or wet clothing. ● Insulate yourself from work and ground. 	<ul style="list-style-type: none"> ● Keep flammable materials away. 	<ul style="list-style-type: none"> ● Wear eye, ear and body protection.
Spanish AVISO DE PRECAUCION	<ul style="list-style-type: none"> ● No toque las partes o los electrodos bajo carga con la piel o ropa mojada. ● Aíslese del trabajo y de la tierra. 	<ul style="list-style-type: none"> ● Mantenga el material combustible fuera del área de trabajo. 	<ul style="list-style-type: none"> ● Protéjase los ojos, los oídos y el cuerpo.
French ATTENTION	<ul style="list-style-type: none"> ● Ne laissez ni la peau ni des vêtements mouillés entrer en contact avec des pièces sous tension. ● Isolez-vous du travail et de la terre. 	<ul style="list-style-type: none"> ● Gardez à l'écart de tout matériel inflammable. 	<ul style="list-style-type: none"> ● Protégez vos yeux, vos oreilles et votre corps.
German WARNUNG	<ul style="list-style-type: none"> ● Berühren Sie keine stromführenden Teile oder Elektroden mit Ihrem Körper oder feuchter Kleidung! ● Isolieren Sie sich von den Elektroden und dem Erdboden! 	<ul style="list-style-type: none"> ● Entfernen Sie brennbares Material! 	<ul style="list-style-type: none"> ● Tragen Sie Augen-, Ohren- und Körperschutz!
Portuguese ATENÇÃO	<ul style="list-style-type: none"> ● Não toque partes elétricas e electrodos com a pele ou roupa molhada. ● Isole-se da peça e terra. 	<ul style="list-style-type: none"> ● Mantenha inflamáveis bem guardados. 	<ul style="list-style-type: none"> ● Use proteção para a vista, ouvido e corpo.
Japanese 注意事項	<ul style="list-style-type: none"> ● 通電中の電気部品、又は溶材にヒフやぬれた布で触れないこと。 ● 施工物やアースから身体が絶縁されている様にして下さい。 	<ul style="list-style-type: none"> ● 燃えやすいものの側での溶接作業は絶対にしてはなりません。 	<ul style="list-style-type: none"> ● 目、耳及び身体に保護具をして下さい。
Chinese 警告	<ul style="list-style-type: none"> ● 皮肤或湿衣物切勿接触带电部件及焊条。 ● 使你自已与地面和工作件绝缘。 	<ul style="list-style-type: none"> ● 把一切易燃物品移离工作场所。 	<ul style="list-style-type: none"> ● 佩戴眼、耳及身体劳动保护用具。
Korean 위험	<ul style="list-style-type: none"> ● 전도체나 용접봉을 젖은 형갑 또는 피부로 절대 접촉치 마십시오. ● 모재와 접지를 접촉치 마십시오. 	<ul style="list-style-type: none"> ● 인화성 물질을 접근시키지 마십시오. 	<ul style="list-style-type: none"> ● 눈, 귀와 몸에 보호장구를 착용하십시오.
Arabic تحذير	<ul style="list-style-type: none"> ● لا تلمس الاجزاء التي يسري فيها التيار الكهربائي أو الألكترود بجسد الجسم أو بالملابس المبللة بالماء. ● ضع عازلا على جسمك خلال العمل. 	<ul style="list-style-type: none"> ● ضع المواد القابلة للاشتعال في مكان بعيد. 	<ul style="list-style-type: none"> ● ضع أدوات وملابس واقية على عينيك وأذنيك وجسمك.

READ AND UNDERSTAND THE MANUFACTURER'S INSTRUCTION FOR THIS EQUIPMENT AND THE CONSUMABLES TO BE USED AND FOLLOW YOUR EMPLOYER'S SAFETY PRACTICES.

SE RECOMIENDA LEER Y ENTENDER LAS INSTRUCCIONES DEL FABRICANTE PARA EL USO DE ESTE EQUIPO Y LOS CONSUMIBLES QUE VA A UTILIZAR, SIGA LAS MEDIDAS DE SEGURIDAD DE SU SUPERVISOR.

LISEZ ET COMPRENEZ LES INSTRUCTIONS DU FABRICANT EN CE QUI REGARDE CET EQUIPMENT ET LES PRODUITS A ETRE EMPLOYES ET SUIVEZ LES PROCEDURES DE SECURITE DE VOTRE EMPLOYEUR.

LESEN SIE UND BEFOLGEN SIE DIE BETRIEBSANLEITUNG DER ANLAGE UND DEN ELEKTRODENEINSATZ DES HERSTELLERS. DIE UNFALLVERHÜTUNGSVORSCHRIFTEN DES ARBEITGEBERS SIND EBENFALLS ZU BEACHTEN.

<ul style="list-style-type: none"> ● Keep your head out of fumes. ● Use ventilation or exhaust to remove fumes from breathing zone. 	<ul style="list-style-type: none"> ● Turn power off before servicing. 	<ul style="list-style-type: none"> ● Do not operate with panel open or guards off. 	WARNING
<ul style="list-style-type: none"> ● Los humos fuera de la zona de respiración. ● Mantenga la cabeza fuera de los humos. Utilice ventilación o aspiración para gases. 	<ul style="list-style-type: none"> ● Desconectar el cable de alimentación de poder de la máquina antes de iniciar cualquier servicio. 	<ul style="list-style-type: none"> ● No operar con panel abierto o guardas quitadas. 	Spanish AVISO DE PRECAUCION
<ul style="list-style-type: none"> ● Gardez la tête à l'écart des fumées. ● Utilisez un ventilateur ou un aspirateur pour ôter les fumées des zones de travail. 	<ul style="list-style-type: none"> ● Débranchez le courant avant l'entretien. 	<ul style="list-style-type: none"> ● N'opérez pas avec les panneaux ouverts ou avec les dispositifs de protection enlevés. 	French ATTENTION
<ul style="list-style-type: none"> ● Vermeiden Sie das Einatmen von Schweißrauch! ● Sorgen Sie für gute Be- und Entlüftung des Arbeitsplatzes! 	<ul style="list-style-type: none"> ● Strom vor Wartungsarbeiten abschalten! (Netzstrom völlig öffnen; Maschine anhalten!) 	<ul style="list-style-type: none"> ● Anlage nie ohne Schutzgehäuse oder Innenschutzverkleidung in Betrieb setzen! 	German WARNUNG
<ul style="list-style-type: none"> ● Mantenha seu rosto da fumaça. ● Use ventilação e exaustão para remover fumo da zona respiratória. 	<ul style="list-style-type: none"> ● Não opere com as tampas removidas. ● Desligue a corrente antes de fazer serviço. ● Não toque as partes elétricas nuas. 	<ul style="list-style-type: none"> ● Mantenha-se afastado das partes moventes. ● Não opere com os painéis abertos ou guardas removidas. 	Portuguese ATENÇÃO
<ul style="list-style-type: none"> ● ヒュームから頭を離すようにして下さい。 ● 換気や排煙に十分留意して下さい。 	<ul style="list-style-type: none"> ● メンテナンス・サービスに取りかかる際には、まず電源スイッチを必ず切して下さい。 	<ul style="list-style-type: none"> ● パネルやカバーを取り外したまま機械操作をしないで下さい。 	Japanese 注意事項
<ul style="list-style-type: none"> ● 頭部遠離煙霧。 ● 在呼吸區使用通風或排風器除煙。 	<ul style="list-style-type: none"> ● 維修前切斷電源。 	<ul style="list-style-type: none"> ● 儀表板打開或沒有安全罩時不準作業。 	Chinese 警告
<ul style="list-style-type: none"> ● 얼굴로부터 용접가스를 멀리하십시오. ● 호흡지역으로부터 용접가스를 제거하기 위해 가스제거기나 통풍기를 사용하십시오. 	<ul style="list-style-type: none"> ● 보수전에 전원을 차단하십시오. 	<ul style="list-style-type: none"> ● 판넬이 열린 상태로 작동치 마십시오. 	Korean 위험
<ul style="list-style-type: none"> ● ابعِد رأسك بعيداً عن الدخان. ● استعمل التهوية أو جهاز ضغط الدخان للخارج لكي تبعد الدخان عن المنطقة التي تتنفس فيها. 	<ul style="list-style-type: none"> ● أقطع التيار الكهربائي قبل القيام بأية صيانة. 	<ul style="list-style-type: none"> ● لا تشغيل هذا الجهاز اذا كانت الاغطية الحديدية الواقية ليست عليه. 	Arabic تحذير

LEIA E COMPREENDA AS INSTRUÇÕES DO FABRICANTE PARA ESTE EQUIPAMENTO E AS PARTES DE USO, E SIGA AS PRÁTICAS DE SEGURANÇA DO EMPREGADOR.

使う機械や溶材のメーカーの指示書をよく読み、まず理解して下さい。そして貴社の安全規定に従って下さい。

請詳細閱讀並理解製造廠提供的說明以及應該使用的銀焊材料，並請遵守貴方的有閣勞動保護規定。

이 제품에 동봉된 작업지침서를 숙지하시고 귀사의 작업자 안전수칙을 준수하시기 바랍니다.

اقرأ بتمعن وافهم تعليمات المصنع المنتج لهذه المعدات والمواد قبل استعمالها واتبع تعليمات الوقاية لصاحب العمل.



• World's Leader in Welding and Cutting Products •

• Sales and Service through Subsidiaries and Distributors Worldwide •

Cleveland, Ohio 44117-1199 U.S.A. TEL: 216.481.8100 FAX: 216.486.1751 WEB SITE: www.lincolnelectric.com