

Commander™ 500

For use with machines having Code Numbers: **10599 (Standard),**
10600 (Deluxe)
10704 (Standard),
10705 (Deluxe)

Safety Depends on You

Lincoln arc welding and cutting equipment is designed and built with safety in mind. However, your overall safety can be increased by proper installation ... and thoughtful operation on your part. **DO NOT INSTALL, OPERATE OR REPAIR THIS EQUIPMENT WITHOUT READING THIS MANUAL AND THE SAFETY PRECAUTIONS CONTAINED THROUGHOUT.** And, most importantly, think before you act and be careful.

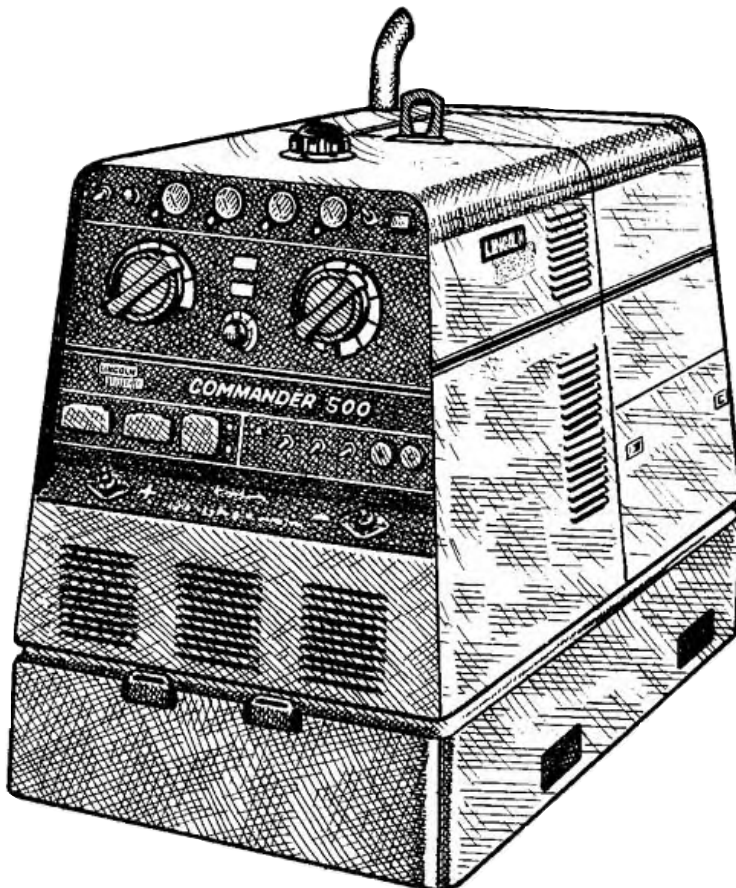

Date of Purchase: _____
 Serial Number: _____
 Code Number: _____
 Model: _____
 Where Purchased: _____

OPERATOR'S MANUAL



Copyright © 2001 Lincoln Global Inc.

• World's Leader in Welding and Cutting Products •
 • Sales and Service through Subsidiaries and Distributors Worldwide •
 Cleveland, Ohio 44117-1199 U.S.A. TEL: 216.481.8100 FAX: 216.486.1751 WEB SITE: www.lincolnelectric.com

⚠ WARNING

⚠ CALIFORNIA PROPOSITION 65 WARNINGS ⚠

For Diesel Engines: Diesel engine exhaust and some of its constituents are known to the State of California to cause cancer, birth defects, and other reproductive harm.

For Gasoline Engines: The engine exhaust from this product contains chemicals known to the State of California to cause cancer, birth defects, or other reproductive harm.

ARC WELDING CAN BE HAZARDOUS. PROTECT YOURSELF AND OTHERS FROM POSSIBLE SERIOUS INJURY OR DEATH. KEEP CHILDREN AWAY. PACEMAKER WEARERS SHOULD CONSULT WITH THEIR DOCTOR BEFORE OPERATING.

Read and understand the following safety highlights. For additional safety information, it is strongly recommended that you purchase a copy of "Safety in Welding & Cutting - ANSI Standard Z49.1" from the American Welding Society, P.O. Box 351040, Miami, Florida 33135 or CSA Standard W117.2-1974. A Free copy of "Arc Welding Safety" booklet E205 is available from the Lincoln Electric Company, 22801 St. Clair Avenue, Cleveland, Ohio 44117-1199.

BE SURE THAT ALL INSTALLATION, OPERATION, MAINTENANCE AND REPAIR PROCEDURES ARE PERFORMED ONLY BY QUALIFIED INDIVIDUALS.



FOR ENGINE powered equipment.

1.a. Turn the engine off before troubleshooting and maintenance work unless the maintenance work requires it to be running.



1.b. Operate engines in open, well-ventilated areas or vent the engine exhaust fumes outdoors.



1.c. Do not add the fuel near an open flame welding arc or when the engine is running. Stop the engine and allow it to cool before refueling to prevent spilled fuel from vaporizing on contact with hot engine parts and igniting. Do not spill fuel when filling tank. If fuel is spilled, wipe it up and do not start engine until fumes have been eliminated.

1.d. Keep all equipment safety guards, covers and devices in position and in good repair. Keep hands, hair, clothing and tools away from V-belts, gears, fans and all other moving parts when starting, operating or repairing equipment.

1.e. In some cases it may be necessary to remove safety guards to perform required maintenance. Remove guards only when necessary and replace them when the maintenance requiring their removal is complete. Always use the greatest care when working near moving parts.



1.f. Do not put your hands near the engine fan. Do not attempt to override the governor or idler by pushing on the throttle control rods while the engine is running.

1.g. To prevent accidentally starting gasoline engines while turning the engine or welding generator during maintenance work, disconnect the spark plug wires, distributor cap or magneto wire as appropriate.



1.h. To avoid scalding, do not remove the radiator pressure cap when the engine is hot.



ELECTRIC AND MAGNETIC FIELDS may be dangerous

2.a. Electric current flowing through any conductor causes localized Electric and Magnetic Fields (EMF). Welding current creates EMF fields around welding cables and welding machines

2.b. EMF fields may interfere with some pacemakers, and welders having a pacemaker should consult their physician before welding.

2.c. Exposure to EMF fields in welding may have other health effects which are now not known.

2.d. All welders should use the following procedures in order to minimize exposure to EMF fields from the welding circuit:

2.d.1. Route the electrode and work cables together - Secure them with tape when possible.

2.d.2. Never coil the electrode lead around your body.

2.d.3. Do not place your body between the electrode and work cables. If the electrode cable is on your right side, the work cable should also be on your right side.

2.d.4. Connect the work cable to the workpiece as close as possible to the area being welded.

2.d.5. Do not work next to welding power source.

Mar '95



ELECTRIC SHOCK can kill.

3.a. The electrode and work (or ground) circuits are electrically "hot" when the welder is on. Do not touch these "hot" parts with your bare skin or wet clothing. Wear dry, hole-free gloves to insulate hands.

3.b. Insulate yourself from work and ground using dry insulation. Make certain the insulation is large enough to cover your full area of physical contact with work and ground.

In addition to the normal safety precautions, if welding must be performed under electrically hazardous conditions (in damp locations or while wearing wet clothing; on metal structures such as floors, gratings or scaffolds; when in cramped positions such as sitting, kneeling or lying, if there is a high risk of unavoidable or accidental contact with the workpiece or ground) use the following equipment:

- Semiautomatic DC Constant Voltage (Wire) Welder.
- DC Manual (Stick) Welder.
- AC Welder with Reduced Voltage Control.

3.c. In semiautomatic or automatic wire welding, the electrode, electrode reel, welding head, nozzle or semiautomatic welding gun are also electrically "hot".

3.d. Always be sure the work cable makes a good electrical connection with the metal being welded. The connection should be as close as possible to the area being welded.

3.e. Ground the work or metal to be welded to a good electrical (earth) ground.

3.f. Maintain the electrode holder, work clamp, welding cable and welding machine in good, safe operating condition. Replace damaged insulation.

3.g. Never dip the electrode in water for cooling.

3.h. Never simultaneously touch electrically "hot" parts of electrode holders connected to two welders because voltage between the two can be the total of the open circuit voltage of both welders.

3.i. When working above floor level, use a safety belt to protect yourself from a fall should you get a shock.

3.j. Also see Items 6.c. and 8.



ARC RAYS can burn.

4.a. Use a shield with the proper filter and cover plates to protect your eyes from sparks and the rays of the arc when welding or observing open arc welding. Headshield and filter lens should conform to ANSI Z87.1 standards.

4.b. Use suitable clothing made from durable flame-resistant material to protect your skin and that of your helpers from the arc rays.

4.c. Protect other nearby personnel with suitable, non-flammable screening and/or warn them not to watch the arc nor expose themselves to the arc rays or to hot spatter or metal.



FUMES AND GASES can be dangerous.

5.a. Welding may produce fumes and gases hazardous to health. Avoid breathing these fumes and gases. When welding, keep your head out of the fume. Use enough ventilation and/or exhaust at the arc to keep

fumes and gases away from the breathing zone. **When welding with electrodes which require special ventilation such as stainless or hard facing (see instructions on container or MSDS) or on lead or cadmium plated steel and other metals or coatings which produce highly toxic fumes, keep exposure as low as possible and below Threshold Limit Values (TLV) using local exhaust or mechanical ventilation. In confined spaces or in some circumstances, outdoors, a respirator may be required. Additional precautions are also required when welding on galvanized steel.**

5.b. Do not weld in locations near chlorinated hydrocarbon vapors coming from degreasing, cleaning or spraying operations. The heat and rays of the arc can react with solvent vapors to form phosgene, a highly toxic gas, and other irritating products.

5.c. Shielding gases used for arc welding can displace air and cause injury or death. Always use enough ventilation, especially in confined areas, to insure breathing air is safe.

5.d. Read and understand the manufacturer's instructions for this equipment and the consumables to be used, including the material safety data sheet (MSDS) and follow your employer's safety practices. MSDS forms are available from your welding distributor or from the manufacturer.

5.e. Also see item 1.b.

Mar '95

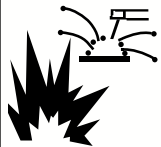

WELDING SPARKS can cause fire or explosion.

6.a. Remove fire hazards from the welding area.

If this is not possible, cover them to prevent the welding sparks from starting a fire.

Remember that welding sparks and hot materials from welding can easily go through small cracks and openings to adjacent areas. Avoid welding near hydraulic lines. Have a fire extinguisher readily available.

6.b. Where compressed gases are to be used at the job site, special precautions should be used to prevent hazardous situations. Refer to "Safety in Welding and Cutting" (ANSI Standard Z49.1) and the operating information for the equipment being used.

6.c. When not welding, make certain no part of the electrode circuit is touching the work or ground. Accidental contact can cause overheating and create a fire hazard.

6.d. Do not heat, cut or weld tanks, drums or containers until the proper steps have been taken to insure that such procedures will not cause flammable or toxic vapors from substances inside. They can cause an explosion even though they have been "cleaned". For information, purchase "Recommended Safe Practices for the Preparation for Welding and Cutting of Containers and Piping That Have Held Hazardous Substances", AWS F4.1 from the American Welding Society (see address above).

6.e. Vent hollow castings or containers before heating, cutting or welding. They may explode.

6.f. Sparks and spatter are thrown from the welding arc. Wear oil free protective garments such as leather gloves, heavy shirt, cuffless trousers, high shoes and a cap over your hair. Wear ear plugs when welding out of position or in confined places. Always wear safety glasses with side shields when in a welding area.

6.g. Connect the work cable to the work as close to the welding area as practical. Work cables connected to the building framework or other locations away from the welding area increase the possibility of the welding current passing through lifting chains, crane cables or other alternate circuits. This can create fire hazards or overheat lifting chains or cables until they fail.

6.h. Also see item 1.c.

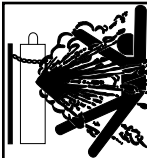

CYLINDER may explode if damaged.

7.a. Use only compressed gas cylinders containing the correct shielding gas for the process used and properly operating regulators designed for the gas and pressure used. All hoses, fittings, etc. should be suitable for the application and maintained in good condition.

7.b. Always keep cylinders in an upright position securely chained to an undercarriage or fixed support.

7.c. Cylinders should be located:

- Away from areas where they may be struck or subjected to physical damage.

- A safe distance from arc welding or cutting operations and any other source of heat, sparks, or flame.

7.d. Never allow the electrode, electrode holder or any other electrically "hot" parts to touch a cylinder.

7.e. Keep your head and face away from the cylinder valve outlet when opening the cylinder valve.

7.f. Valve protection caps should always be in place and hand tight except when the cylinder is in use or connected for use.

7.g. Read and follow the instructions on compressed gas cylinders, associated equipment, and CGA publication P-1, "Precautions for Safe Handling of Compressed Gases in Cylinders," available from the Compressed Gas Association 1235 Jefferson Davis Highway, Arlington, VA 22202.



FOR ELECTRICALLY powered equipment.

8.a. Turn off input power using the disconnect switch at the fuse box before working on the equipment.

8.b. Install equipment in accordance with the U.S. National Electrical Code, all local codes and the manufacturer's recommendations.

8.c. Ground the equipment in accordance with the U.S. National Electrical Code and the manufacturer's recommendations.

Mar '95

PRÉCAUTIONS DE SÛRETÉ

Pour votre propre protection lire et observer toutes les instructions et les précautions de sûreté spécifiques qui paraissent dans ce manuel aussi bien que les précautions de sûreté générales suivantes:

Sûreté Pour Soudage A L'Arc

1. Protégez-vous contre la secousse électrique:
 - a. Les circuits à l'électrode et à la pièce sont sous tension quand la machine à souder est en marche. Eviter toujours tout contact entre les parties sous tension et la peau nue ou les vêtements mouillés. Porter des gants secs et sans trous pour isoler les mains.
 - b. Faire très attention de bien s'isoler de la masse quand on soude dans des endroits humides, ou sur un plancher métallique ou des grilles métalliques, principalement dans les positions assis ou couché pour lesquelles une grande partie du corps peut être en contact avec la masse.
 - c. Maintenir le porte-électrode, la pince de masse, le câble de soudage et la machine à souder en bon et sûr état de fonctionnement.
 - d. Ne jamais plonger le porte-électrode dans l'eau pour le refroidir.
 - e. Ne jamais toucher simultanément les parties sous tension des porte-électrodes connectés à deux machines à souder parce que la tension entre les deux pinces peut être le total de la tension à vide des deux machines.
 - f. Si on utilise la machine à souder comme une source de courant pour soudage semi-automatique, ces précautions pour le porte-électrode s'appliquent aussi au pistolet de soudage.
2. Dans le cas de travail au dessus du niveau du sol, se protéger contre les chutes dans le cas où on reçoit un choc. Ne jamais enrouler le câble-électrode autour de n'importe quelle partie du corps.
3. Un coup d'arc peut être plus sévère qu'un coup de soleil, donc:
 - a. Utiliser un bon masque avec un verre filtrant approprié ainsi qu'un verre blanc afin de se protéger les yeux du rayonnement de l'arc et des projections quand on soude ou quand on regarde l'arc.
 - b. Porter des vêtements convenables afin de protéger la peau de soudeur et des aides contre le rayonnement de l'arc.
 - c. Protéger l'autre personnel travaillant à proximité au soudage à l'aide d'écrans appropriés et non-inflammables.
4. Des gouttes de laitier en fusion sont émises de l'arc de soudage. Se protéger avec des vêtements de protection libres de l'huile, tels que les gants en cuir, chemise épaisse, pantalons sans revers, et chaussures montantes.
5. Toujours porter des lunettes de sécurité dans la zone de soudage. Utiliser des lunettes avec écrans latéraux dans les zones où l'on pique le laitier.

6. Eloigner les matériaux inflammables ou les recouvrir afin de prévenir tout risque d'incendie dû aux étincelles.
7. Quand on ne soude pas, poser la pince à un endroit isolé de la masse. Un court-circuit accidentel peut provoquer un échauffement et un risque d'incendie.
8. S'assurer que la masse est connectée le plus près possible de la zone de travail qu'il est pratique de le faire. Si on place la masse sur la charpente de la construction ou d'autres endroits éloignés de la zone de travail, on augmente le risque de voir passer le courant de soudage par les chaînes de levage, câbles de grue, ou autres circuits. Cela peut provoquer des risques d'incendie ou d'échauffement des chaînes et des câbles jusqu'à ce qu'ils se rompent.
9. Assurer une ventilation suffisante dans la zone de soudage. Ceci est particulièrement important pour le soudage de tôles galvanisées plombées, ou cadmiées ou tout autre métal qui produit des fumées toxiques.
10. Ne pas souder en présence de vapeurs de chlore provenant d'opérations de dégraissage, nettoyage ou pistolage. La chaleur ou les rayons de l'arc peuvent réagir avec les vapeurs du solvant pour produire du phosgène (gas fortement toxique) ou autres produits irritants.
11. Pour obtenir de plus amples renseignements sur la sûreté, voir le code "Code for safety in welding and cutting" CSA Standard W 117.2-1974.

PRÉCAUTIONS DE SÛRETÉ POUR LES MACHINES À SOUDER À TRANSFORMATEUR ET À REDRESSEUR

1. Relier à la terre le châssis du poste conformément au code de l'électricité et aux recommandations du fabricant. Le dispositif de montage ou la pièce à souder doit être branché à une bonne mise à la terre.
2. Autant que possible, l'installation et l'entretien du poste seront effectués par un électricien qualifié.
3. Avant de faire des travaux à l'intérieur de poste, la débrancher à l'interrupteur à la boîte de fusibles.
4. Garder tous les couvercles et dispositifs de sûreté à leur place.

Mar. '93

Thank You

for selecting a **QUALITY** product by Lincoln Electric. We want you to take pride in operating this Lincoln Electric Company product ••• as much pride as we have in bringing this product to you!

Please Examine Carton and Equipment For Damage Immediately

When this equipment is shipped, title passes to the purchaser upon receipt by the carrier. Consequently, Claims for material damaged in shipment must be made by the purchaser against the transportation company at the time the shipment is received.

Please record your equipment identification information below for future reference. This information can be found on your machine nameplate.

Model Name & Number _____

Code & Serial Number _____

Date of Purchase _____

Whenever you request replacement parts for or information on this equipment always supply the information you have recorded above.

Read this Operators Manual completely before attempting to use this equipment. Save this manual and keep it handy for quick reference. Pay particular attention to the safety instructions we have provided for your protection. The level of seriousness to be applied to each is explained below:

⚠ WARNING

This statement appears where the information **must** be followed **exactly** to avoid **serious personal injury** or **loss of life**.

⚠ CAUTION

This statement appears where the information **must** be followed to avoid **minor personal injury** or **damage to this equipment**.

TABLE OF CONTENTS

	Page
Safety	i-iv
<hr/>	
Installation	Section A
Technical Specifications	A-1
Safety Precautions.....	A-2
Location/ Ventilation.....	A-2
Storing.....	A-2
Stacking.....	A-2
Angle of Operation	A-2
Lifting.....	A-3
High Altitude Operation.....	A-3
High Temperature Operation.....	A-3
Towing	A-3
Pre-Operation Engine Service.....	A-4
Oil.....	A-4
Fuel	A-4
Fuel Cap.....	A-4
Engine Cooling System.....	A-4
Battery Connection	A-4
Muffler Outlet Pipe	A-5
Spark Arrester	A-5
High Frequency Generators for TIG Applications.....	A-5
Remote Control	A-5
Welding Terminals	A-5
Welding Output Cables	A-6
Machine Grounding	A-6
Auxiliary Power Receptacles	A-6
Standby Power Connections	A-6
Connection of Lincoln Electric Wire Feeders	A-8
<hr/>	
Operation	Section B
Safety Instructions	B-1
General Description.....	B-1
Recommended Applications	B-1
Design Features and Advantages.....	B-1
Welding Capability	B-2
Controls and Settings	B-3
Engine Controls.....	B-3
Welder Controls	B-5
Auxiliary Power Controls	B-5
Engine Operation.....	B-6
Starting the Engine	B-6
Stopping the Engine.....	B-6
Break-In Period	B-7
Typical Fuel Consumption.....	B-7
Welder Operation.....	B-7
Stick Welding.....	B-7
TIG Welding	B-7
Wire Feed (Constant Voltage) Welding	B-9
Auxiliary Power Operation	B-9
Simultaneous Welding and Auxiliary Power Loads.....	B-9
Extension Cord Length Recommendations.....	B-10

TABLE OF CONTENTS

Accessories	Section C
Optional Field Installed Accessories	C-1
Recommended Optional Equipment	C-1
High Frequency Generators For TIG Applications	C-1

Maintenance	Section D
Safety Precautions	D-1
Routine and Periodic Maintenance	D-1
Engine Maintenance.....	D-1
Air Filter.....	D-1
Fuel Filters	D-2
Cooling System.....	D-3
Cooling Blower Belt.....	D-3
Battery Handling	D-3
Nameplate / Warning Decal Maintenance.....	D-4
Welder / Generator Maintenance	D-4
Engine Maintenance Components	D-4

Troubleshooting	Section E
------------------------------	------------------

Diagrams and Dimension Print.....	Section F
--	------------------

Parts Lists	P343 Series
--------------------------	--------------------

TECHNICAL SPECIFICATIONS - Commander 500 (K1639-1 & -2)

INPUT - DIESEL ENGINE					
Make/Model	Description	Speed (RPM)	Displacement	Starting System	Capacities
Deutz F3L 912 Diesel Engine	3 cylinder 44 HP(33 kw) @ 1800 RPM	High Idle 1900 Low Idle 1400 Full Load 1800	173 cu. in (2.83 L)	12VDC battery & Starter	Fuel: 25 gal. 94.6 L Oil: 9.5 Qts. 9.0 L
			Bore x Stroke 3.94" x 4.72" (100mm x 120mm)		
RATED OUTPUT - WELDER					
Duty Cycle	Welding Output			Volts at Rated Amps	
100%	500 Amps (DC multi-purpose)			40 Volts	
60%	550 Amps (DC multi-purpose)			36 Volts	
50%	575 Amps (DC multi-purpose)			35 Volts	
OUTPUT - WELDER AND GENERATOR					
Welding Range		Open Circuit Voltage		Auxiliary Power ¹	
30 - 575 Amps CC/CV 15 - 200 Amps TIG		90 Max OCV @ 1900 RPM		120/240 VAC 12,000 Watts, 60 Hz. 100% Duty Cycle	
PHYSICAL DIMENSIONS					
HEIGHT ²	WIDTH		DEPTH		WEIGHT
42.0 in. 1066.8 mm	31.5 in. 800.1 mm		63.1 in. 1602.7 mm		1640 lbs.(744 kg) (Approx.)

1. Output rating in watts is equivalent to volt-amperes at unity power factor.

Output voltage is within +/- 10% at all loads up to rated capacity. When welding, available auxiliary power will be reduced.

2. Top of Enclosure. Add 8.9" (226.1mm) for exhaust.

COMMANDER 500



Read this entire installation section before you start installation.

SAFETY PRECAUTIONS

WARNING

Do not attempt to use this equipment until you have thoroughly read all operating and maintenance manuals supplied with your machine. They include important safety precautions, detailed engine starting, operating and maintenance instructions and parts lists.



ELECTRIC SHOCK can kill.

- Do not touch electrically live parts such as output terminals or internal wiring.
- Insulate yourself from the work and ground.
- Always wear dry insulating gloves.



ENGINE EXHAUST can kill.

- Use in open, well ventilated areas or vent exhaust outside
- Do not stack anything near the engine.



MOVING PARTS can injure.

- Do not operate with doors open or guards off.
- Stop engine before servicing.
- Keep away from moving parts

Only qualified personnel should install, use or service this equipment

LOCATION / VENTILATION

The welder should be located to provide an unrestricted flow of clean, cool air to the cooling air inlets and to avoid restricting the cooling air outlets. Also, locate the welder so that the engine exhaust fumes are properly vented to an outside area.

STORING

1. Store the machine in a cool, dry place when it is not in use. Protect it from dust and dirt. Keep it where it can't be accidentally damaged from construction activities, moving vehicles, and other hazards.
2. Drain the engine oil and refill with fresh 10W30 oil. Run the engine for about five minutes to circulate oil to all the parts. See the MAINTENANCE section of this manual for details on changing oil.
3. Remove the battery, recharge it, and adjust the electrolyte level. Store the battery in a dry, dark place.

STACKING

Commander 500 machines cannot be stacked.

ANGLE OF OPERATION

To achieve optimum engine performance the Commander 500 should be run in a level position. The maximum angle of operation for the Deutz engine is 20 degrees in a direction to cause the control panel to be angled up, 30 degrees for side to side tilting and for the control panel to be angled down. If the engine is to be operated at an angle, provisions must be made for checking and maintaining the oil level at the normal (FULL) oil capacity in the crankcase. When operating the welder at an angle, the effective fuel capacity will be slightly less than the specified 25 gallons.

LIFTING

The Commander lift bale should be used to lift the machine. The Commander is shipped with the lift bale retracted. Before attempting to lift the Commander the lift bale must be secured in a raised position. Secure the lift bale as follows:

- a. Open the engine compartment door.
- b. Locate the 2 access holes on the upper middle region of compartment wall just below the lift bale.
- c. Use the lifting strap to raise the lift bale to the full upright position. This will align the mounting holes on the lift bale with the access holes.
- d. Secure the lift bale with 2 thread forming screws. The screws are provided in the shipped loose parts bag.

⚠ WARNING



FALLING EQUIPMENT can cause injury.

- Do not lift this machine using lift bale if it is equipped with a heavy accessory such as a trailer or gas cylinder.
- Lift only with equipment of adequate lifting capacity.
- Be sure machine is stable when lifting.

HIGH ALTITUDE OPERATION

At higher altitudes, output derating may be necessary. For maximum rating, derate the welder output 5% for every 300 meters (984 ft.) above 1500 meters (4920 ft.). For output of 500A and below, derate the welder output 5% for every 300 meters (984 ft.) above 2100 meters (6888 ft.)

Contact a Deutz Service Representative for any engine adjustments that may be required.

HIGH TEMPERATURE OPERATION

At temperatures above 30°C (86°F), output voltage derating is necessary. For maximum output current ratings, derate welder voltage rating 2 volts for every 10°C (21°F) above 30°C (86°F).

TOWING

The recommended trailer for use with this equipment for road, in-plant and yard towing by a vehicle⁽¹⁾ is Lincoln's K953-1. If the user adapts a non-Lincoln trailer, he must assume responsibility that the method of attachment and usage does not result in a safety hazard nor damage the welding equipment. Some of the factors to be considered are as follows:

1. Design capacity of trailer vs. weight of Lincoln equipment and likely additional attachments.
2. Proper support of, and attachment to, the base of the welding equipment so that there will be no undue stress to the trailer's framework.
3. Proper placement of the equipment on the trailer to insure stability side to side and front to back when being moved and when standing by itself.
4. Typical conditions of use, such as travel speed, roughness of surface on which the trailer will be operated, and environmental conditions.
5. Proper preventative maintenance of trailer.
6. Conformance with federal, state and local laws.¹

¹Consult applicable federal, state and local laws regarding specific requirements for use on public highways.

PRE-OPERATION ENGINE SERVICE

READ the engine operating and maintenance instructions supplied with this machine.

⚠ WARNING



- Keep hands away from the engine muffler or HOT engine parts.
- Stop engine and allow to cool before fueling.

- Do not smoke when fueling.
- Fill fuel tank at a moderate rate and do not overfill.
- Wipe up spilled fuel and allow fumes to clear before starting engine.
- Keep sparks and flame away from tank.

OIL

The Commander is shipped with the engine crankcase filled with high quality SAE 10W-30 oil (API class CD or better). Check the oil level before starting the engine. If it is not up to the full mark on the dip stick, add oil as required. Check the oil level every four hours of running time during the first 35 running hours. Refer to the engine Operator's Manual for specific oil recommendations and break-in information. The oil change interval is dependent on the quality of the oil and the operating environment. Refer to the engine Operator's Manual for the proper service and maintenance intervals.

FUEL USE DIESEL FUEL ONLY



Fill the fuel tank with clean, fresh diesel fuel. The capacity of the fuel tank is 25 gallons (94.6 liters). See engine Operator's Manual for specific fuel recommendations. The Commander 500 Deluxe is protected by a low fuel shutdown to prevent the engine from running out of fuel. The machine will indicate a low fuel condition by turning on the low fuel light. A time of 30 minutes will elapse once the low fuel light illuminates before the machine will shut-down. A restart of the machine will restart the timer to allow the operator to override this feature. The amount of reserve fuel remaining in the tank after the first shutdown will vary from machine to machine. The operator must determine the amount of fuel remaining before re-starting the machine. **Running out of fuel may require bleeding the fuel injection pump.**

NOTE: Before starting the engine, open the fuel shutoff valve (pointer to be in line with hose).

FUEL CAP

Remove the plastic cap covering from the Fuel Tank Filler neck and install the Fuel Cap.

ENGINE COOLING SYSTEM

The Deutz engine is air cooled by a belt driven axial blower. The oil cooler and engine cooling fins should be blown out with compressed air or steam to maintain proper cooling (See the engine Owners Manual for procedures and frequency).

BATTERY CONNECTION

⚠ WARNING



- GASES FROM BATTERY** can explode.
- Keep sparks, flame and cigarettes away from battery.

To prevent **EXPLOSION** when:

- **INSTALLING A NEW BATTERY** — disconnect negative cable from old battery first and connect to new battery last.
- **CONNECTING A BATTERY CHARGER** — remove battery from welder by disconnecting negative cable first, then positive cable and battery clamp. When reinstalling, connect negative cable last. Keep well ventilated.
- **USING A BOOSTER** — connect positive lead to battery first then connect negative lead to negative battery lead at engine foot.

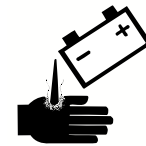

BATTERY ACID can burn eyes and skin.

- Wear gloves and eye protection and be careful when working near battery.
- Follow instructions printed on battery.

IMPORTANT: To prevent **ELECTRICAL DAMAGE** WHEN:

- Installing new batteries.
- Using a booster.

Use correct polarity — **Negative Ground.**

The Commander is shipped with the negative battery cable disconnected. Before you operate the machine, make sure the Engine Switch is in the OFF position and attach the disconnected cable securely to the negative (-) battery terminal.

Remove the insulating cap from the negative battery terminal. Replace and tighten negative battery cable terminal. **NOTE:** This machine is furnished with a wet charged battery; if unused for several months, the battery may require a booster charge. Be sure to use the correct polarity when charging the battery.

COMMANDER 500



MUFFLER OUTLET PIPE

Remove the plastic plug covering the muffler outlet tube. Using the clamp provided secure the outlet pipe to the outlet tube with the pipe positioned such that it will direct the exhaust in the desired direction.

SPARK ARRESTER

Some federal, state or local laws may require that gasoline or diesel engines be equipped with exhaust spark arresters when they are operated in certain locations where unarrested sparks may present a fire hazard. The standard muffler included with this welder does not qualify as a spark arrester. When required by local regulations, a suitable spark arrester, must be installed and properly maintained.

CAUTION

An incorrect arrester may lead to damage to the engine or adversely affect performance.

HIGH FREQUENCY GENERATORS FOR TIG APPLICATIONS

The K799 Hi-Freq Unit and the K930-1 or-2 TIG Module are suitable for use with the Commander 500. The Commander 500 is equipped with the required R.F. bypass circuitry for the connection of high frequency generating equipment. The high frequency bypass network supplied with the K799 Hi-Freq Unit does NOT need to be installed into the Commander 500.

The Commander 500 and any high frequency generating equipment must be properly grounded. See the K799 Hi-Freq Unit and the K930-1 or-2 TIG Module operating manuals for complete instructions on installation, operation, and maintenance.

REMOTE CONTROL

OUTPUT

The Commander 500 is equipped with a 6 pin & 14-pin connector. The 6 pin connector is for connecting the K857 or K857-1 Remote Control (Optional) or in the case of TIG welding applications, with the foot or hand Amptrol. (K870 or K963-1 respectively).

The 14 pin connector is used to directly connect a wire feeder or TIG Module (K930-1 or-2) control cable. When remote output control is used, the output control toggle switch is to be set at "Remote."

NOTE: When using the 14 pin connector, if the wire feeder has a built in power source output control, do not connect anything to the 6 pin connector.

WELDING TERMINALS

The Commander is equipped with a toggle switch for selecting "hot" welding terminals when in the "WELDING TERMINALS ALWAYS ON" position or "cold" welding terminals when in the "WELDING TERMINALS REMOTELY CONTROLLED" position.

WELDING OUTPUT CABLES

With the engine off, route the electrode and work cables thru the strain relief bracket provided on the front of the base and connect to the terminals provided. These connections should be checked periodically and tightened if necessary.

Listed in Table A.1 are copper cable sizes recommended for the rated current and duty cycle. Lengths stipulated are the distance from the welder to work and back to the welder again. Cable sizes are increased for greater lengths primarily for the purpose of minimizing cable voltage drop.

Table A.1 Combined Length of Electrode and Work Cables.

AMPS @ 100% Duty Cycle	TOTAL COMBINED LENGTH OF ELECTRODE AND WORK CABLES		
	Up to 150 FT.	150-200 FT.	200-250 FT.
500	3/0 AWG	3/0 AWG	4/0 AWG

MACHINE GROUNDING

Because this portable engine driven welder creates its own power, it is not necessary to connect its frame to an earth ground, unless the machine is connected to premises wiring (home, shop, etc.).

To prevent dangerous electric shock, other equipment powered by this engine driven welder must:

- a) be grounded to the frame of the welder using a grounded type plug,
- or
- b) be double insulated.

When this welder is mounted on a truck or trailer, its frame must be securely connected to the metal frame of the vehicle. When this engine driven welder is connected to premises wiring such as that in a home or shop, its frame must be connected to the system earth ground. See further connection instructions in the section entitled "Standby Power Connections" as well as the article on grounding in the latest U.S. National Electrical Code and the local code.

In general, if the machine is to be grounded, it should be connected with a #8 or larger copper wire to a solid earth ground such as a metal water pipe going into the ground for at least ten feet and having no insulated

joints, or to the metal framework of a building which has been effectively grounded. The U.S. National Electrical Code lists a number of alternate means of grounding electrical equipment. A machine grounding stud marked with the  symbol is provided on the front of the welder.

AUXILIARY POWER RECEPTACLES

The auxiliary power capacity of the Commander 500 is 12,000 watts of 60 Hz, single phase power. The auxiliary power capacity rating in watts is equivalent to volt-amperes at unity power factor. The maximum permissible current of the 240 VAC output is 50 A. The 240 VAC output can be split to provide two separate 120 VAC outputs with a maximum permissible current of 50 A per output to two separate 120 VAC branch circuits. The output voltage is within $\pm 10\%$ at all loads up to rated capacity.

NOTE: The 120/240V receptacle has two 120V outlets of different phases and cannot be paralleled.

The Commander has two 20 Amp-120VAC (5-20R) duplex receptacles and one 50 Amp-120/240 VAC (14-50R) receptacle. The 120/240 VAC receptacle can be split for single phase 120 VAC operation. The auxiliary power receptacles should only be used with three wire grounded type plugs or approved double insulated tools with two wire plugs. The current rating of any plug used with the system must be at least equal to the current capacity of the associated receptacle.

STANDBY POWER CONNECTIONS

The Commander 500 is suitable for temporary, standby or emergency power using the engine manufacturer's recommended maintenance schedule.

The Commander 500 can be permanently installed as a standby power unit for 240 volt-3 wire, 50 amp service. Connections must be made by a licensed electrician who can determine how the 120/240 VAC power can be adapted to the particular installation and comply with all applicable electrical codes. The following information can be used as a guide by the electrician for most applications. Refer to the connection diagram shown in Figure A.2.

1. Install the double-pole, double-throw switch between the power company meter and the premises disconnect.

Switch rating must be the same or greater than the customer's premises disconnect and service over current protection.

COMMANDER 500



2. Take necessary steps to assure load is limited to the capacity of the Commander by installing a 50 amp, 240 VAC double pole circuit breaker. Maximum rated load for each leg of the 240 VAC auxiliary is 50 amperes. Loading above the rated output will reduce output voltage below the allowable -10% of rated voltage which may damage appliances or other motor-driven equipment and may result in overheating of the Commander 500 engine.

3. Install a 50 amp 120/240 VAC plug (NEMA Type 14-50) to the double-pole circuit breaker using No. 6, 4 conductor cable of the desired length. (The 50 amp, 120/240 VAC plug is available in the optional K802R plug kit.)

4. Plug this cable into the 50 Amp 120/240 Volt receptacle on the Commander 500 case front.

Figure A.2 Connection of the Commander 500 to Premises Wiring

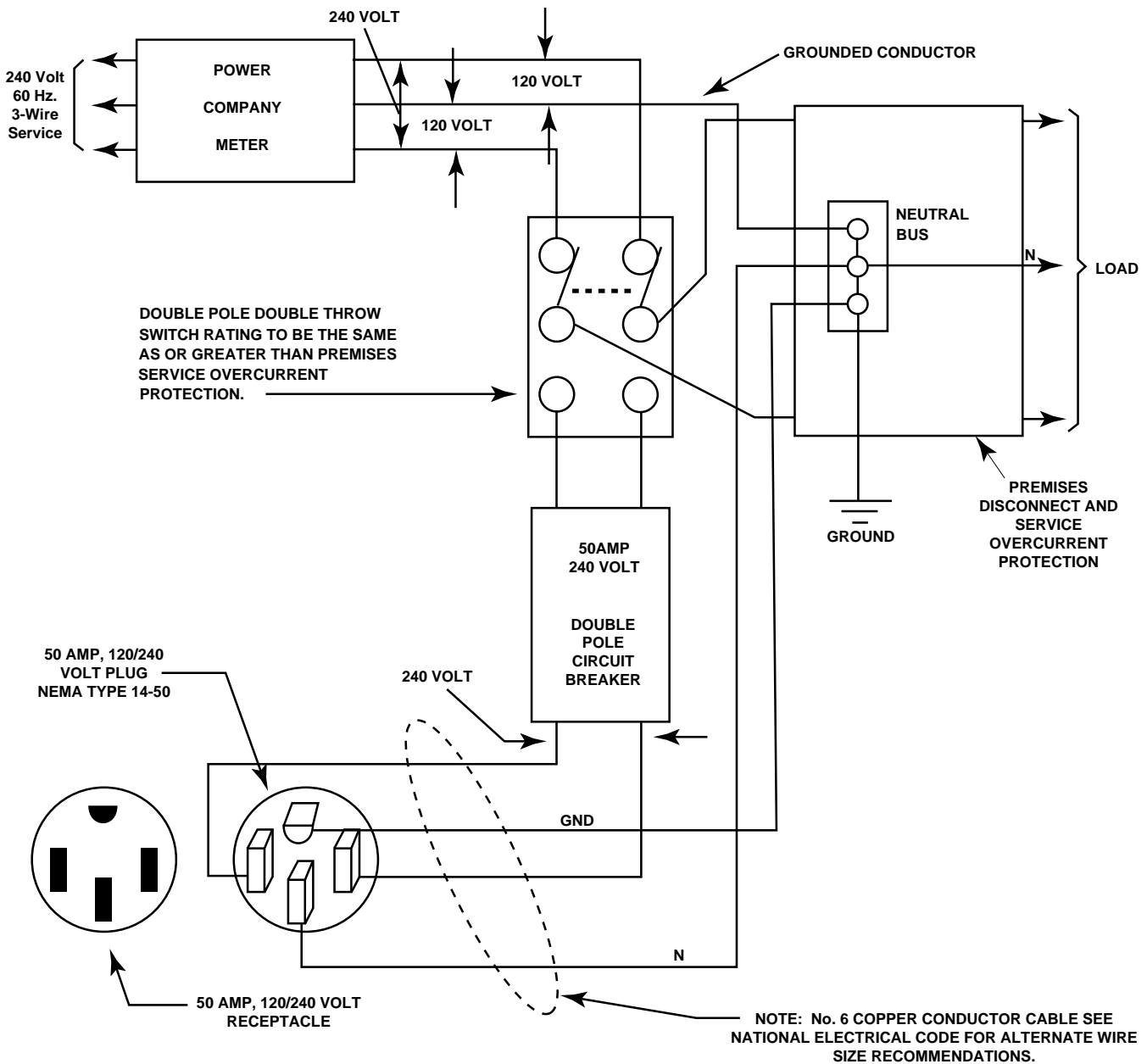

COMMANDER 500



CONNECTION OF LINCOLN ELECTRIC WIRE FEEDERS

⚠ WARNING

Shut off welder before making any electrical connections.

CONNECTION OF THE LN-25 TO THE COMMANDER 500

The LN-25 with or without an external contactor may be used with the Commander 500. See the appropriate connection diagram in the DIAGRAMS section.

NOTE: The LN-25 (K431) Remote Control Module and (K432) Remote Cable are not recommended for use with the Commander 500.

- a. Shut the welder off.
- b. For electrode Positive, connect the electrode cable from the LN-25 to the “+” terminal of the welder and work cable to the “-” terminal of the welder. For electrode Negative, connect the electrode cable from the LN-25 to the “-” terminal of the welder and work cable to the “+” terminal of the welder.
- c. Attach the single lead from the front of the LN-25 to work using the spring clip at the end of the lead. This is a sense lead to supply current to the wire feeder motor; it does not carry welding current.
- d. Set the SELECTOR switch to the “WIRE WELDING” position.
- e. Set the “WELDING TERMINALS” switch to “WELDING TERMINALS ALWAYS ON”
- f. Adjust the “ARC CONTROL” knob to desired crispness. Generally, welding is best if the “ARC CONTROL” is set to SOFT for MIG and CRISP for Innershield.
- g. Set the “IDLE” switch to the “AUTO” position. When not welding, the Commander 500 engine will be at the low idle speed. If you are using an LN-25 with an internal contactor, the electrode is not energized until the gun trigger is closed.

⚠ CAUTION

If you are using an LN-25 without an internal contactor, the electrode will be energized when the Commander 500 is started.

- h. When the gun trigger is closed, the current sensing circuit will cause the Commander 500 engine to go to the high idle speed, the wire will begin to feed and the welding process started. When welding is stopped, the engine will revert to low idle speed after approximately 12 seconds unless welding is resumed.

CONNECTION OF LN-7 OR LN-8 TO THE COMMANDER 500

- a. Shut the welder off.
- b. Connect the LN-7 or LN-8 per instructions on the appropriate connection diagram in the DIAGRAMS section.
- c. Set the “LOCAL /REMOTE” switch to “REMOTE” for the LN-8 or LN-7 with a K857 (or K857-1) remote voltage control cable attached; “LOCAL” for LN-7 with no remote voltage control.
- d. Set the “WIRE FEEDER VOLTMETER” switch to either “+” or “-” as required by the electrode being used.
- e. Set the “SELECTOR” switch to the “WIRE WELDING” position.
- f. Adjust the “ARC CONTROL” knob to desired Crispness. SOFT for MIG and CRISP for Innershield.
- g. Set the “WELDING TERMINALS” switch to the “WELDING TERMINALS” REMOTELY CONTROLLED” position.
- h. Set the “IDLE” switch to the “HIGH” position. When not welding, the Commander 500 engine will be at the low idle speed.

CONNECTION OF AN LN-23P WIRE FEEDER TO THE COMMANDER 500

- a. Shut the welder off.
- b. Connect the LN-23P per instructions on the appropriate connection diagram in the DIAGRAMS section. (NOTE): When connecting an LN-23P to the Commander 500, a K350-1 adapter kit must be used.
- c. Set the "VOLTMETER" switch to "-".
- d. Set the "SELECTOR" switch to "WIRE WELDING" position.
- e. Set the "WELDING TERMINALS" switch to "WELDING TERMINALS ALWAYS ON".
- f. Set the ARC CONTROL to desired crispness. SOFT for MIG - crisp for Innershield.
- g. Set the "LOCAL/ REMOTE" switch to the desired setting depending upon where the power sources output is being controlled from.
- h. Set the "IDLE" switch to the "HIGH" position. If you are using an LN-23P with the K350-1 adapter kit, the electrode is not energized until the gun trigger is closed.

CONNECTION OF AN NA-3 AUTOMATIC WELDING SYSTEM TO THE COMMANDER 500

For connection diagrams and instructions for connecting an NA-3 Welding System to the Commander 500, refer to the NA-3 Welding System instruction manual. The connection diagram for the LN-8 can be used for connecting the NA-3.

CONNECTION OF AN LN-742 TO THE COMMANDER 500 (Requires optional K1597-1, 42 VAC Transformer Kit).

- a. Shut the welder off.
- b. Connect the LN-742 per instructions on the appropriate connection diagram in the DIAGRAMS section.
- c. Set the "LOCAL/ REMOTE" switch to REMOTE.
- d. Set the "WIRE FEEDER VOLTMETER" switch to either "+" or "-" as required by the electrode being used.
- e. Set the "SELECTOR" switch to the "WIRE WELDING-CV" position.
- f. Adjust the "ARC CONTROL" knob to desired Crispness. SOFT for MIG and CRISP for Innershield.
- g. Set the "WELDING TERMINALS" switch to the "WELDING TERMINALS" REMOTELY CONTROLLED" position.
- h. Set the "IDLE" switch to the "AUTO" position. When not welding, the Commander 500 engine will be at the low idle speed.

OPERATING INSTRUCTIONS

Read and understand this entire section before operating your Commander 500.

SAFETY INSTRUCTIONS

WARNING

Do not attempt to use this equipment until you have thoroughly read all operating and maintenance manuals supplied with your machine. They include important safety precautions, detailed engine starting, operating and maintenance instructions and parts lists.



ELECTRIC SHOCK can kill.

- Do not touch electrically live parts such as output terminals or internal wiring.
- Insulate yourself from the work and ground.
- Always wear dry insulating gloves.



ENGINE EXHAUST can kill.

- Use in open, well ventilated areas or vent exhaust outside
- Do not stack anything near the engine.



MOVING PARTS can injure.

- Do not operate with doors open or guards off.
- Stop engine before servicing.
- Keep away from moving parts

Only qualified personnel should operate this equipment.

ADDITIONAL SAFETY PRECAUTIONS

Always operate the welder with the hinged door closed and the side panels in place as these provide maximum protection from moving parts and insure proper cooling air flow.

GENERAL DESCRIPTION

The Commander 500 is a diesel engine-driven welding power source. The machine uses a brush type alternating current generator for DC multi-purpose welding and for 120/240 VAC auxiliary standby power. The welding control system uses state of the art **Chopper Technology**. The Commander 500 is **not recommended** for pipe thawing.

The generator has a single sealed bearing for maintenance free service. The rotor is a copper wound design with two slip rings and brushes. The stator is wound entirely with heavy gauge copper wire and insulated with NEMA class F insulation material. The stator is then impregnated with three layers of high quality varnish. After the stator is assembled using tie bars, the entire assembly covered with an environmentally protective coating. These measures insure trouble-free operation in the harshest environments.

The fuel tank is made from high density polyethylene and holds 25 gallons of diesel fuel. This will provide enough fuel to run for more than 12 hours at full load.

The Deutz F3L-912 engine is equipped with a standard, heavy duty, combination fuel filter/water separator element.

RECOMMENDED APPLICATIONS WELDER

The Commander 500 provides excellent constant current DC welding output for stick (SMAW) and TIG welding. The Commander 500 also provides excellent constant voltage DC welding output for MIG (GMAW) and Innershield (FCAW) welding.

GENERATOR

The Commander 500 provides smooth 120/240 VAC output for auxiliary power and emergency standby power.

DESIGN FEATURES AND ADVANTAGES

K1639-2 Commander 500 Deluxe Model Features For Welding:

- Excellent DC multi-purpose welding for stick, MIG, TIG, cored wire and arc gouging applications.
- 30 to 500 amps output in five slope controlled ranges for out-of position and pipe electrodes, one constant current output range for general purpose welding, one constant voltage range for MIG wire and cored wire welding and one 15-200 amp range for "Touch Start" TIG welding.

COMMANDER 500



- 100% duty cycle at 500 amps output and 50% duty cycle at 575 amps output.
- Dual 3-digit output meters are provided (optional on K1639-1) for presetting the weld amperage or voltage and displaying the actual amperage and voltage during welding. The meters use superbrite L.E.D.'s for improved readability in full sunlight.
- Standard remote control capability with 14 pin and 6 pin connectors for easy connection of Lincoln remote control accessories.
- An internal "Solid State" contactor allows for the selection of "hot" or "cold" output terminals with a toggle switch on the control panel.
- "Arc Control" potentiometer in Wire and Stick modes for precise adjustment of arc characteristics.
- Advanced circuitry to prevent pop-outs in the five slope modes.
- Indicator lights for low oil pressure, high oil temperature, engine alternator low output/broken belt and low fuel level (on K1639-2 only).
- Automatic low fuel shutdown before running out of fuel (K1639-2 only).
- Engine hour meter standard on all models.
- Extended range 25 gallon (94.6 l) fuel tank.
- Automatic idler reduces engine speed when not welding or drawing auxiliary power. This feature reduces fuel consumption and extends engine life.
- Compact size fits crosswise in full size pick-up truck.
- Single side engine service.
- Copper alternator windings and high temperature insulation for dependability and long life.
- New paint system on case and base for outstanding corrosion protection.

FOR AUXILIARY POWER

- 12,000 watts of 120/240 VAC, 60Hz auxiliary power.
- Power for tools, 120/240 VAC lights, electric pumps and for standby emergency power.
- Drive a 5 HP motor (provided it is started under no load).
- Two 20 amp 120 VAC duplex receptacles for up to 40 amps of 120 VAC power.
- One 50 amp, 120/240 VAC dual voltage receptacle for up to 50 amps of 240 VAC, and up to 50 amps per side to separate branch circuits (not in parallel) of 120 VAC single phase auxiliary power. Allows easy connection to premises wiring.
- Weld and AC auxiliary power at the same time (within machine total capacity).

OTHER FEATURES

- Deutz 3-cylinder, air/oil cooled diesel engine. Designed for long life, easy maintenance and excellent fuel economy.
- Engine protection system shuts the engine down for low oil pressure, high oil temperature or a broken fan/engine alternator belt.
- Gauges for oil pressure, oil temperature, engine alternator output and fuel level.

K1639-1 Commander 500 Standard Model

- The K1639-1 is the standard version of the Commander 500, and has all the features of the K1639-2 Deluxe version except that there are no gauges, low fuel light nor dual output meters. This version does have fully functional engine protection for low oil pressure, high oil temperature, and alternator output with associated lights.
- A field installed Dual Output Meter and Gauge Kit (K-1596-2) is available for the K1639-1 Commander 500. The kit includes dual output meters, oil pressure gauge, oil temperature gage, and alternator ammeter.

WELDING CAPABILITY

The Commander 500 is rated at 500 amps, 40 VDC at 100% duty cycle and 575 amps, 36 VDC at 50% duty cycle. The maximum open circuit voltage at 1900 RPM is 90 volts. The weld current is variable from 30 to 575 amps.

COMMANDER 500



CONTROLS AND SETTINGS

All welder and engine controls are located on the case front panel. Refer to Figure B.1 and the explanations that follow.

Figure B.1 Case Front Panel Controls

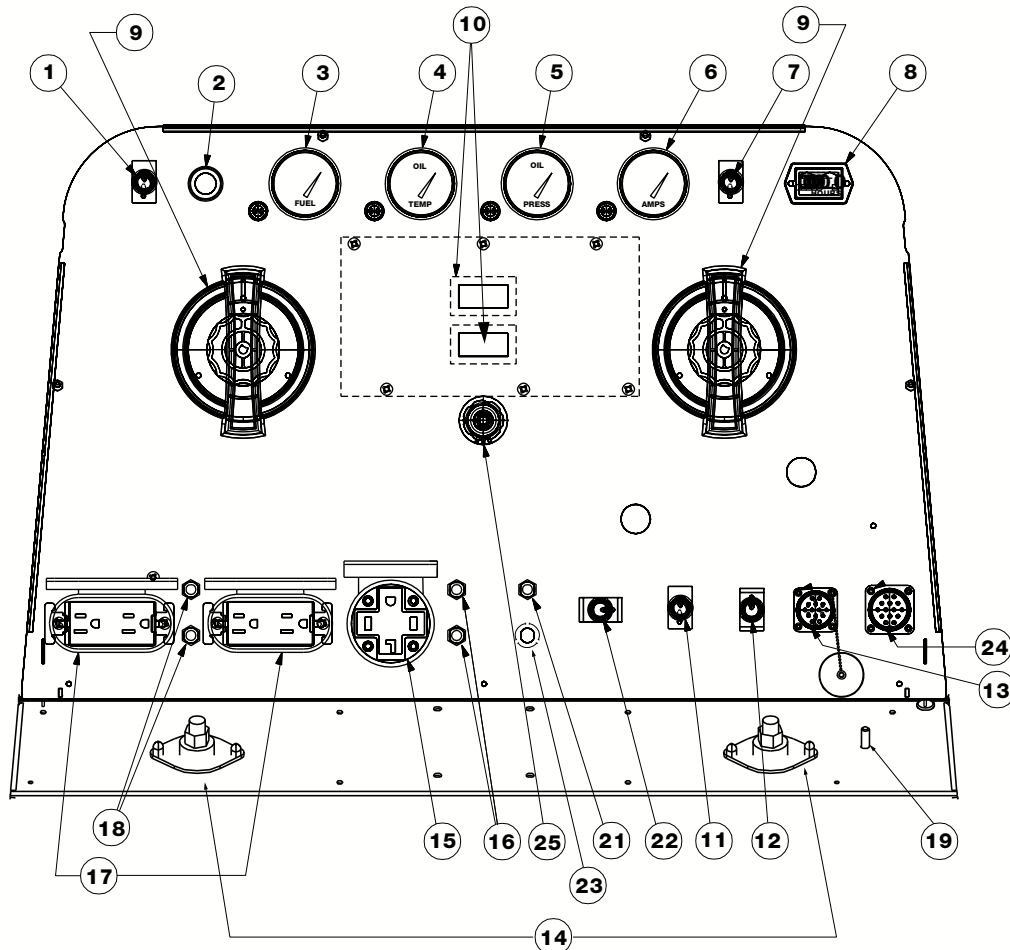

ENGINE CONTROLS (Items 1 through 8)

1. RUN- STOP SWITCH

When placed in the "RUN" position, this switch energizes the fuel solenoid and other electric accessories. When placed in the "STOP" position, the flow of fuel to the injection pump is stopped to shut down the engine. (Note: If the switch is left in the "RUN" position and the engine is not running, the fuel solenoid will be engaged for 15 seconds and then shut down. This is to protect the battery from discharge. After 15 seconds, the Run / Stop switch must be toggled off then on before starting.)

2. START PUSHBUTTON

Energizes the starter motor to crank the engine. With the engine "Run / Stop" switch in the "Run" position, push and hold the Start button to crank the engine; release as the engine starts. Start button must be depressed for a minimum of two seconds. Do not press while engine is running since this can cause damage to the ring gear and/or starter motor.

3. FUEL LEVEL GAUGE AND LIGHT

(K1639-2 only) - Displays the level of diesel fuel in the 25-gallon fuel tank. The  yellow light turns on when the fuel gage reaches the reserve level. Once the reserve level is reached, the engine protection system will shut down the engine after 30 minutes of operation. The machine can be restarted and operated for an additional 30 minutes before the protection system will shut down the engine. This ability to override the engine protection is to allow the operator to "finish up" if necessary. The operator must watch the fuel level closely to prevent running out of fuel and having to bleed the system.

COMMANDER 500

LINCOLN
ELECTRIC

4. ENGINE TEMPERATURE GAUGE (K1639-2 Std., K1639-1 Opt.) AND LIGHT

The gauge displays the engine oil temperature. The yellow temperature light remains off under normal operating temperatures. If the light turns on, the engine protection system will shut down the engine. Check for restrictions at the engine cooling air inlets and outlets (consult the engine Operator's Manual). Check for loose or disconnected leads at the temperature sender located on the engine. Check engine cooling blower belt. Also, check to be sure that the welder loads are within the rating of the welder. The light will remain on when the engine has been shut down due to an over-temperature condition.

5. OIL PRESSURE GAUGE (K1639-2 Std., K1639-1 Opt.) AND LIGHT

The gauge displays the engine oil pressure when the engine is running. The yellow oil pressure light remains off with proper oil pressure. If the light turns on, the engine protection system will stop the engine. Check for proper oil level and add oil if necessary. Check for loose or disconnected leads at the oil pressure sender located on the engine. The light will go on and stay on when the RUN-STOP switch is switched to the "Run" position with engine not running.

6. ENGINE ALTERNATOR AMMETER (K1639-2 Std., K1639-1 Opt.) AND LIGHT

The yellow engine alternator light is off when battery charging system is functioning normally. If light turns on, the engine protection system will shut down the engine. Check the engine cooling blower belt. Also, the alternator or the voltage regulator may not be operating correctly. The light may also come on due to a faulty flashing circuit. The light will remain on when the engine has been shut down due to a fault in the alternator, regulator, or the cooling blower belt.

7. IDLER SWITCH

Has two positions as follows:

A) In the "High" position  , the engine runs at the high idle speed controlled by the governor.

B) In the "Auto"  /  position, the idler operates as follows:

a. When switched from "High" to "Auto" or after starting the engine, the engine will operate at full speed for approximately 12 seconds and then go to low idle speed.

b. When the electrode touches the work or power is drawn for lights or tools (approximately 100 Watts minimum) the engine accelerates and operates at full speed.

c. When welding ceases or the AC power load is turned off, a fixed time delay of approximately 12 seconds starts.

d. If the welding or AC power load is not restarted before the end of the time delay, the idler reduces the engine speed to low idle speed.

e. The engine will automatically return to high idle speed when the welding load or A.C. power load is reapplied.

Idler Operational exceptions

When the WELDING TERMINALS switch is in the "Welding Terminals Remotely Controlled" position the idler will operate as follows:

a. When the triggering device (Amptrol, Arc Start Switch, etc.) is pressed the engine will accelerate and operate at full speed provided a welding load is applied within approximately 12 seconds.

- If the triggering device remains pressed but no welding load is applied within approximately 12 seconds the engine will return to low idle speed.

- If the triggering device is released or welding ceases the engine will return to low idle speed after approximately 12 seconds.

8. HOUR METER



The hour meter displays the total time that the engine has been running. This meter is a useful indicator for scheduling preventive maintenance.

WELDER CONTROLS (Items 9 through 14)

9. OUTPUT SELECTOR SWITCH & OUTPUT CONTROL

These two controls allow you to select between various welding output slopes and adjust the desired welding output. Refer to Table B.1 for a description of how these two controls work.

Table B.1 Output Range Switch and Output Control Functions

Application	 Selector Switch ¹	 Control ²
Sloped Output for Pipe Welding.	5 Range Settings 90, 150, 250, 350, 500 (Max. current on each setting)	Provides a fine adjustment of welding current from Min (1) to Max (10) within each range
Touch Start TIG Welding	1 Range setting 15-200 Amps	
Constant Current Output for Fabrication and General Purpose Welding	1 Range setting 30-575 Amps	
Constant Voltage Output for MIG Wire or CORED WIRE Welding	1 Range setting 12 to 48 Volts	Provides Fine Voltage Adjustment

¹ If the SELECTOR switch is positioned between settings the previous setting is maintained until the switch is properly positioned on a setting.

² CONTROL also controls O.C.V. while in the 5 sloped output ranges.

10. DIGITAL OUTPUT METERS

The digital output meters are located in the center of the control panel between the two large control knobs. The meters allow the output current level to be set prior to welding in stick mode, and voltage level to be set prior to welding in the wire modes. During the welding process the meters display the actual output current and voltage, within $\pm 5\%$ accuracy.

11. WELDING TERMINALS SWITCH

The toggle switch on the control panel labeled “Welding Terminals Always On” and “Welding Terminals Remotely Controlled”: is used to control the operation of the “solid state contactor” which allows for the selection of “Hot” or “Cold” welding terminals.

With the switch in the “Welding Terminals Always On” position the contactor is closed and the welding terminals are always “Hot”.

With the switch in the “Welding Terminals Remotely Controlled” position the contactor operation is controlled by an Amptrol, Arc Start Switch or some other type of triggering device through the use of a control cable connected to the 14-pin MS connector.

When the triggering device is pressed the contactor is closed and the welding terminals are “Hot”.

When the triggering device is released the contactor is opened and the welding terminals are “Cold”.

12. LOCAL /REMOTE SWITCH

The toggle switch on the control panel labeled “Local/Remote” gives the operator the option of controlling the output at the welder control panel or at a remote station.

For remote control the toggle switch is set in the “Remote” position.

For control at the welder control panel, the toggle switch is set in the “Local” position.

13. 6 - PIN CONNECTOR

The 6-pin connector located on the control panel allows for connection of interfacing equipment.

14. WELD OUTPUT TERMINALS + AND -

These 1/2 - 13 studs with flange nuts provide welding connection points for the electrode and work cables. For positive polarity welding the electrode cable connects to the “+” terminal and the work cable connects to this “-” terminal. For negative polarity welding the work cable connects to the “+” terminal and the electrode cable connects to this “-” terminal.

AUXILIARY POWER CONTROLS (Items 15 - 19)

15. 120/240VAC RECEPTACLE

This is a 120/240VAC (14-50R) receptacle that provides 240VAC or can be split for 120VAC single phase auxiliary power. This receptacle has a 50 amp rating. Refer to the AUXILIARY POWER RECEPTACLES section in the installation chapter for further information about this receptacle. Also refer to the AUXILIARY POWER OPERATION section later in this chapter.

16. 50 AMP CIRCUIT BREAKERS

These circuit breakers provide separate overload current protection for each 120V circuit at the 240V receptacle.

17. 120VAC RECEPTACLES

These two 120VAC (5-20R) receptacles provide 120VAC for auxiliary power. Each receptacle has a 20 amp total rating. Refer to the AUXILIARY POWER RECEPTACLES section in the installation chapter for further information about these receptacles. Also refer to the AUXILIARY POWER OPERATION section later in this chapter.

18. 20 AMP CIRCUIT BREAKERS

These circuit breakers provide separate overload current protection for each 120V receptacle.



19. GROUND STUD

Provides a connection point for connecting the machine case to earth ground for the safest grounding procedure. Refer to "MACHINE GROUNDING" in the Installation chapter for proper machine grounding information.

21. 15 AMP CIRCUIT BREAKER

This circuit breaker provides overload protection for the 120 VAC in the 14-pin connector.

22. VOLTMETER +/- SWITCH

Changes the polarity display on the wire feeder.

23. 20 AMP CIRCUIT BREAKER (Optional)

This circuit breaker provides overload protection for the 42 VAC in the 14-pin connector.

24. 14 - PIN CONNECTOR

For quick connection of interfacing equipment.

25. ARC CONTROL

The "ARC CONTROL" potentiometer is active in two modes: "STICK / CC" and "WIRE WELDING" with different purposes in each mode.

"STICK / CC" mode: In this mode, the "ARC CONTROL" knob sets the short circuit current during stick welding. Increasing the number from 1 to 10 increases the short circuit current. This prevents sticking of the electrode to the plate at low welding current settings. This also increases spatter. It is recommended that the control be set to the minimum number without electrode sticking.

"WIRE WELDING" mode: In this mode increasing the number from 1 to 10 changes the arc from soft and washed in to crisp and narrow. It acts as an inductance control. The proper setting depends on the application and operator preference.

In general, Mig welding performs best in the "SOFT" range and Innershield in the "CRISP" range.

ENGINE OPERATION

STARTING THE ENGINE

1. Open the engine compartment door and check that the fuel shutoff valve located to the left of the fuel filter housing is in the open position (lever to be in line with the hose).
2. Check for proper oil level on the oil dipstick. Close engine compartment door.
3. Remove all plugs connected to the AC power receptacles.
4. Set IDLER switch to "AUTO".
5. Set the RUN/STOP switch to "RUN". Observe that all engine protection lights momentarily turn on, some lights may turn off before starting. Check the fuel gauge (K1639-2 only) to make sure that there is an adequate fuel level.
6. Press and hold the engine START button for a minimum of 2 seconds.
7. Release the engine START button when the engine starts.
8. Check that the indicator lights are off. If the LOW FUEL light is on (K1639-2 only), the engine will shutdown 30 minutes after starting. If any other indicator light is on after starting, the engine will shutdown in a few seconds. Investigate any indicated problem.
9. Allow the engine to warm up at low idle speed for several minutes before applying a load and/or switching to high idle. Allow a longer warm up time in cold weather.

COLD WEATHER STARTING

With a fully charged battery and the proper weight oil, the engine should start satisfactorily even down to about 0°F. If the engine must be frequently started below 10°F, it may be desirable to install the optional ether starter kit (K825-1). Installation and operating instructions are included in the kit.

STOPPING THE ENGINE

1. Switch the RUN/STOP switch to "STOP". This turns off the voltage supplied to the shutdown solenoid. A backup shutdown can be accomplished by shutting off the fuel valve located on the fuel line.

BREAK-IN PERIOD

The engine used to supply power for your welder is a heavy duty, industrial engine. It is designed and built for rugged use. It is very normal for any engine to use small quantities of oil until the break-in is accomplished. Check the oil level twice a day during the break-in period (about 200 running hours).

IMPORTANT

IN ORDER TO ACCOMPLISH THIS BREAK-IN, THE UNIT SHOULD BE SUBJECTED TO HEAVY LOADS, WITHIN THE RATING OF THE MACHINE. AVOID LONG IDLE RUNNING PERIODS.

TYPICAL FUEL CONSUMPTION

Refer to Table B.2 for typical fuel consumption of the Commander 500's Engine for various operating scenarios.

Table B.2 Deutz F3L 912 Engine Fuel Consumption

	Deutz F3L 912 44.2 Hp @ 1800 RPM	Running Time for 25 gallons (Hours)
Low Idle - No Load 1400 RPM	.37 gallons/hour (1.40 liters/hour)	67.6
High Idle - No Load 1900 RPM	.66 gallons/hour (2.50 liters/hour)	37.9
DC CC Weld Output 500 Amps @ 40 Volts	1.94 gallons/hour (7.34 liters/hour)	12.9
Auxiliary Power 12,000 VA	1.31 gallons/hour (4.96 liters/hour)	19.1

WELDER OPERATION

STICK WELDING

The Commander 500 can be used with a broad range of DC stick electrodes.

The SELECTOR switch provides five overlapping slope controlled current ranges. The CONTROL adjusts the current from minimum to maximum within each range. Voltage is also controlled by the CONTROL in the slope controlled setting. These slope controlled settings are intended for "out-of-position" weld-

ing, including pipe welding, where the operator would like to control the current level by changing the arc length.

PIPE WELDING

The Commander 500 is equipped with special circuitry to minimize pop-outs in the five slope modes at any open circuit voltage.

For a soft arc characteristic, set the "SELECTOR" Switch to the lowest setting that still provides the current you need and set the "CONTROL" near maximum. For example: to obtain 140 amps and a soft arc, set the "SELECTOR" Switch to the "150 MAX" position and then adjust the "CONTROL" for 140 amps.

When a forceful "digging" arc is required, use a higher setting and lower the open circuit voltage. For example: to obtain 140 amps and a forceful arc, set the "SELECTOR" to the "250 MAX" position and then adjust the "CONTROL" to get 140 amps.

CONSTANT CURRENT (CC) WELDING

The STICK-CC position of "30 to 575", the "SELECTOR" Switch is designed for horizontal welds with all types of electrodes especially low hydrogen. The "CONTROL" adjusts the full range of 30 to 575 amps. This setting provides a soft, constant current arc. If a more forceful arc is desired, then select the proper range from the slope controlled current ranges.

In the CC mode, sticking can be prevented by adjusting the "ARC CONTROL". Turning this control clockwise, increases the short circuit current, thus preventing sticking. This is another way of increasing arc force.

TIG WELDING

The most clockwise position of the SELECTOR switch is for TIG welding in the range of 15 amps to 200 amps, with a "Touch Start" feature. To initiate a weld, the CONTROL is first set to the desired current and the tungsten is touched to the work. During the time the tungsten is touching the work there is very little voltage or current and, in general, no tungsten contamination. Then, the tungsten is gently lifted off the work in a rocking motion, which establishes the arc.

The Commander 500 can be used in a wide variety of DC Tungsten Inert Gas (TIG) welding applications. In general the "Touch Start" feature allows contamination free starting without the use of a Hi-Freq unit. But the K930-1 or -2 TIG module or K799 Hi-Freq unit, can be used with the Commander 500. The settings for these follow the tungsten current range table.

Table B.3 TYPICAL CURRENT RANGES ⁽¹⁾ FOR TUNGSTEN ELECTRODES ⁽²⁾

Tungsten Electrode Diameter in. (mm)	DCEN (-)	DCEP (+)	Approximate Argon Gas Flow Rate C.F.H. (l/min.)		TIG TORCH Nozzle Size (4), (5)
	1%, 2% Thoriated Tungsten	1%, 2% Thoriated Tungsten	Aluminum	Stainless Steel	
0.010 (.25)	2-15	(3)	3-8 (2-4)	3-8 (2-4)	#4, #5, #6
0.020 (.50)	5-20	(3)	5-10 (3-5)	5-10 (3-5)	
0.040 (1.0)	15-80	(3)	5-10 (3-5)	5-10 (3-5)	
1/16 (1.6)	70-150	10-20	5-10 (3-5)	9-13 (4-6)	#5, #6
3/32 (2.4)	150-250	15-30	13-17 (6-8)	11-15 (5-7)	#6, #7, #8
1/8 (3.2)	250-400	25-40	15-23 (7-11)	11-15 (5-7)	
5/32 (4.0)	400-500	40-55	21-25 (10-12)	13-17 (6-8)	#8, #10
3/16 (4.8)	500-750	55-80	23-27 (11-13)	18-22 (8-10)	
1/4 (6.4)	750-1000	80-125	28-32 (13-15)	23-27 (11-13)	

(1) When used with argon gas. The current ranges shown must be reduced when using argon/helium or pure helium shielding gases.

(2) Tungsten electrodes are classified as follows by the American Welding Society (AWS):

Pure	EWP
1% Thoriated	EWTh-1
2% Thoriated	EWTh-2

Though not yet recognized by the AWS, Ceriated Tungsten is now widely accepted as a substitute for 2% Thoriated Tungsten in AC and DC applications.

(3) DCEP is not commonly used in these sizes.

(4) TIG torch nozzle "sizes" are in multiples of 1/16ths of an inch:

# 4 = 1/4 in.	(6 mm)
# 5 = 5/16 in.	(8 mm)
# 6 = 3/8 in.	(10 mm)
# 7 = 7/16 in.	(11 mm)
# 8 = 1/2 in.	(12.5 mm)
#10 = 5/8 in.	(16 mm)

(5) TIG torch nozzles are typically made from alumina ceramic. Special applications may require lava nozzles, which are less prone to breakage, but cannot withstand high temperatures and high duty cycles.

Commander 500 SETTINGS WHEN USING THE K799 HI-FREQ UNIT

- Set the SELECTOR switch to the "15-200 setting" (TIG)
- Set the IDLER switch to the "HIGH" position.
- Set the LOCAL/REMOTE switch to the "REMOTE" position.
- Set the WELDING TERMINALS switch to the "Welding Terminals Always On" position. This will close the solid state contactor and provide an always "hot" electrode.

(Note: This is necessary because the K799 circuitry with respect to the #2 and #4 leads does not provide the proper signal to open and close the solid state contactor in the Commander 500).

Commander 500 SETTINGS WHEN USING THE K930-1 TIG MODULE

- Set the SELECTOR switch to the 15-200 Setting (TIG).
- Set the IDLER switch to the "AUTO" position.
- Set the LOCAL/REMOTE switch to the "REMOTE" position.
- Set the WELDING TERMINALS switch to the "Welding Terminals Remotely Controlled" position. This will keep the solid state contactor open and provide a "cold" electrode until the triggering device (Amptrol or Arc Start Switch) is pressed.

COMMANDER 500



WIRE FEED (CONSTANT VOLTAGE) WELDING

Connect a wire feeder to the Commander 500 and set welder controls according to the instructions listed earlier in this section.

The Commander 500 in the "WIRE WELDING" position, permits it to be used with a broad range of flux cored wire (Innershield and Outershield) electrodes and solid wires for MIG welding (gas metal arc welding). Welding can be finely tuned using the "ARC CONTROL".

Some recommended Innershield electrodes are: NR-311, NS-3M, NR-207, NR-203 Ni 1%, NR-204-H.

Recommended Outershield electrodes are: 0S-70, 0S-71M.

Some recommended solid wires for MIG welding are: .035 (0.9 mm), .045 (1.1 mm) and .052 (1.3 mm), L-50 and L-56, .035 (0.9 mm) and .045 (1.1 mm) Blue Max MIG 308 LS.

For any electrodes, including the above recommendations, the procedures should be kept within the rating of the machine. For additional electrode information, see Lincoln publications N-675, GS-100 and GS-210.

AUXILIARY POWER OPERATION

Start the engine and set the IDLER control switch to the desired operating mode. Full power is available regardless of the welding control settings, if no welding current is being drawn.

The auxiliary power of the Commander consists of two 20 Amp-120VAC (5-20R) duplex receptacles and one 50 Amp-120/240 VAC (14-50R) receptacle. The 120/240VAC receptacle can be split for single phase 120 VAC operation.

The auxiliary power capacity is 12,000 watts of 60 Hz, single phase power. The auxiliary power capacity rating in watts is equivalent to volt-amperes at unity power factor. The maximum permissible current of the 240 VAC output is 50 A. The 240 VAC output can be split to provide two separate 120 VAC outputs with a maximum permissible current of 50 A per output to two separate 120 VAC branch circuits. Output voltage is within $\pm 10\%$ at all loads up to rated capacity.

NOTE: The 120/240V receptacle has two 120V outputs of different phases and cannot be paralleled.

The auxiliary power receptacles should only be used with three wire grounded type plugs or approved double insulated tools with two wire plugs.

The current rating of any plug used with the system must be at least equal to the current capacity of the associated receptacle.

SIMULTANEOUS WELDING AND AUXILIARY POWER LOADS

It must be noted that the above auxiliary power ratings are with no welding load. Simultaneous welding and power loads are specified in table B.4. The permissible currents shown assume that current is being drawn from either the 120 VAC or 240 VAC supply (not both at the same time).

TABLE B.4 Commander 500 Simultaneous Welding and Power Loads

Welding Output Range Setting	Welding Output	Permissible Power - Watts (Unity Power Factor)	Permissible Auxiliary Current in Amperes	
			@ 120 V \pm 10% *	@ 240 V \pm 10%
30-575	500A/40V	0	0	0
500	500A/40V	0	0	0
350	350A/30V	9500	80*	40
250	250A/29V	12000	100**	50
150	150A/27V	12000	100**	50
90	90A/25V	12000	100**	50

* Each duplex receptacle is limited to 20 amps.

** Not to exceed 50 A per 120 VAC branch circuit when splitting the 240 VAC output.

TABLE B.5 Commander 500 Extension Cord Length Recommendations

Current (Amps)	Voltage (Volts)	Load (Watts)	Maximum Allowable Cord Length in ft. (m) for Conductor Size											
			14 AWG		12 AWG		10 AWG		8 AWG		6 AWG		4 AWG	
15	120	1800	30	(9)	40	(12)	75	(23)	125	(38)	175	(53)	300	(91)
15	240	3600	60	(18)	75	(23)	150	(46)	225	(69)	350	(107)	600	(183)
20	120	2400			30	(9)	50	(15)	88	(27)	138	(42)	225	(69)
20	240	4800			60	(18)	100	(30)	175	(53)	275	(84)	450	(137)
25	240	6000					90	(27)	150	(46)	225	(69)	250	(76)
30	240	7200					75	(23)	120	(37)	175	(53)	300	(91)
38	240	9000							100	(30)	150	(46)	250	(76)
50	240	12000									125	(38)	200	(61)

Conductor size is based on maximum 2.0% voltage drop.

OPTIONAL FIELD INSTALLED ACCESSORIES

K802N POWER PLUG KIT - Provides a plug for each receptacle.

K857 28 ft. (8.5 m) or K857-1 100 ft. (30.4 m) REMOTE CONTROL - Portable control provides same dial range as the output control on the welder from a location up to the specified length from the welder. Has convenient plug for easy connection to the welder. The Commander 500 is equipped with a 6-pin connector for connecting the remote control and a toggle switch for selecting "LOCAL" output control or "REMOTE" output control.

K704 ACCESSORY SET - Includes 35 feet (10 m) of electrode cable and 30 feet (9 m) of work cable, headshield, work clamp and electrode holder. Cable is rated at 500 amps, 60% duty cycle.

K953-1 TWO WHEEL TRAILER - For road, in-plant and yard towing. Road towing with optional fender & light kit. (For highway use, consult applicable federal, state and local laws regarding possible additional requirements)

- K953-1 Trailer
- K958-1 Ball Hitch
- K958-2 Lunette Eye Hitch
- K959-1 Fender & Light Kit
- K965-1 Cable Storage Rack

K825-1 ETHER START KIT - Provides maximum cold weather starting assistance for frequent starting below 10 °F (-12.2 °C). Required Ether tank is not provided with kit.

K899-1 SPARK ARRESTOR KIT - Easily mounts to standard muffler.

K949-1 OIL DRAIN KIT - Includes ball valve, hose and clamp.

K1690-1 (1 Duplex) GFCI Kit - Includes one UL approved 115V ground fault circuit interrupter duplex type receptacle with cover and installation instructions. Replaces the factory installed 115V duplex receptacle. The receptacle of the GFCI duplex is rated at 20 amps, the maximum total current from the GFCI duplex is limited to 20 amps. Two kits are required.

K1596-2 Dual Output Meters and Gauges - Dual output meters provide preset ability of voltage for wire welding and current for stick welding. Measures both current and voltage when welding. Gauges include: battery ammeter, engine temperature, and engine oil pressure. Fuel gauge is not available in kit form.

K1597-1 42vac Transformer Kit. - For products requiring 42 VAC power source.

K1751-1 Cool Weather Kit.-(For Codes Above 10600)
Designed to improve cold weather running in temperatures between 0° to -35°F(-10° to -37°C). Diverts warmer engine compartment air back into the cooling air.

RECOMMENDED OPTIONAL EQUIPMENT

STICK

- K704 Accessory Kit which includes:
- Electrode holder and cable.
 - Ground clamp and cable.
 - Headshield.

K857 Remote Control Kit is optional for remote current control.

TIG

Magnum TIG Torch
Magnum Parts Kit and Argon gas
K930-ALL TIG Module (not required for scratch start DC TIG welding)

K936-1 Control Cable
K870 Foot Amptrol

Also available:

K963-1/-2 Hand Amptrol
K814 Arc Start Switch
K937-22 Control Cable Extension
K937-45 Control Cable Extension
K844-1 Water Valve

WIRE FEED WELDING

- LN-25 • LN-7
- LN-23P • LN-8
- NA-3 • Spool Gun & K488 Module
- LN-742 (requires optional K1597-1 42vac transformer kit).

HIGH FREQUENCY GENERATORS FOR TIG APPLICATIONS

The K799 Hi-Freq Unit and the K930-ALL TIG Modules are suitable for use with the Commander 500. The Commander is equipped with the required R.F. bypass circuitry for the connection of high frequency generating equipment. The high frequency bypass network supplied with the K799 Hi-Freq Unit does NOT need to be installed into the Commander.

The Commander and any high frequency generating equipment must be properly grounded. See the K799 Hi-Freq Unit and the K930-ALL TIG Module operating manuals for complete instructions on installation, operation, and maintenance.

COMMANDER 500



SAFETY PRECAUTIONS

WARNING

- Have a qualified technician do the maintenance and troubleshooting work.
- Turn the engine off before working inside the machine.
- Remove guards only when necessary and replace them when the maintenance requiring their removal is complete.
- Always use the greatest care when working near moving parts.

Read the Safety Precautions in front of this manual and the engine instruction manual before working on this machine.

Keep all equipment safety guards, covers and devices in position and in good repair. Keep hands, hair, clothing and tools away from V-belts, gears, fans and all other moving parts when starting, operating or repairing the equipment.

ROUTINE AND PERIODIC MAINTENANCE

DAILY

- a. Check the crankcase oil level .
- b. Refill the fuel tank to minimize moisture condensation in the tank.
- c. Open the water drain valve located on the bottom of the water separator element 1 or 2 turns and allow to drain into a container suitable for diesel fuel for 2 to 3 seconds. Repeat the above drainage procedure until diesel fuel is detected in the container.

WEEKLY

Blow out the machine with low pressure air periodically. In particularly dirty locations, this may be required once a week.

ENGINE MAINTENANCE

Refer to the “Periodic Checks” section of the Engine Operator’s Manual for the recommended maintenance schedule of the following:

- a) Engine Oil and Filter
- b) Air Cleaner
- c) Fuel Filter - and Delivery System
- d) Cooling Blower Belt
- e) Battery
- f) Cooling System

Refer to Table D.1 at the end of this section for various engine maintenance components.

AIR FILTER

CAUTION

EXCESSIVE AIR FILTER RESTRICTION WILL RESULT IN REDUCED ENGINE LIFE.

The air filter element is a dry cartridge type. It can be cleaned and reused; however, damaged elements should not be reused. Stop engine after 100 hours of running time and clean filter element , replace the filter if necessary. Service air cleaner regularly according to Engine Operator’s Manual.

1. Locate the air filter canister located behind the engine door on the top of the engine.
2. Remove air filter element.
3. Remove loose dirt from element with compressed air or water hose directed from inside out.

Compressed Air: 100 psi maximum with nozzles at least one inch away from element.

Water Hose: 40 psi maximum without nozzle.

4. Soak element in a mild detergent solution for 15 minutes. Do not soak more than 24 hours. Swish element around in the solution to help remove dirt.
5. Rinse elements from inside out with a gentle stream of water (less than 40 psi) to remove all suds and dirt.
6. Dry element before reuse with warm air at less than 160° F (71° C). Do not use a light bulb to dry the element.

7. Inspect for holes and tears by looking through the element toward a bright light. Check for damaged gaskets or dented metal parts. Do not reuse damaged elements. Protect element from dust and damage during drying and storage.

8. Reinstall air filter element.

After six cleanings replace air filter. A cleaned filter will have approximately 70% of the life of a new filter element. A restricted filter element may not appear excessively dirty.

FUEL FILTERS

WARNING

When working on the fuel system



- Keep naked lights away, do not smoke !
- Do not spill fuel !

The Commander 500 is equipped with a Fuel Pre-Filter/Water Separator Assembly located before the lift pump and a Secondary Fuel Filter located after the lift pump and before the fuel injectors. The Fuel Pre-Filter/Water Separator is mounted to the engine block just below the lift pump. The Secondary Fuel Filter is mounted directly to the engine just above the oil filter.

FUEL PRE-FILTER/WATER SEPARATOR ASSEMBLY

The pre-filter is a 150 micron screen designed to protect against gross fuel contamination of the water separator element and the Secondary Fuel Filter. If the pre-filter becomes plugged it may be removed, inspected, cleaned and reinstalled. In general this only needs to be done with each water separator element change (about every 1,000 hrs.) However if at any time excessive fuel contamination is suspected or a sudden fall-off in engine performance is detected the pre-filter screen should be inspected and cleaned. Follow the following procedure:

1. Close the fuel shutoff valve (Lever should be perpendicular to the hose) located on the side of the Fuel Pre-Filter/Water Separator Assembly.
2. Unscrew the cap ring located on the top of the filter header and remove the plastic center cap and O-ring.

3. Remove the large white volume plug located directly under the center cap in the upper cavity of the filter header. Use a small screwdriver (or similar device) to lift the plug part way out of the cavity to assist with its removal.

Be careful not to damage the pre-filter screen with the tool used to remove the plug.

4. Using a pair of pliers, gently tug on the pull tabs of the pre-filter screen in an alternating pattern to gradually remove the pre-filter screen.
5. Brush off any debris and rinse in diesel fuel.
6. Re-install the pre-filter screen into the upper cavity of the filter header making sure the four pull tabs are pointing up. Putting your fingers on the pull tabs, push down evenly until the lower body of the pre-filter screen contacts the floor of the upper cavity.
7. Re-insert the large white volume plug into the upper cavity.
8. Place the O-ring onto the angled seal surface of the filter header and re-install the plastic cap. Make sure its flange rests on the O-ring.
9. Screw on the cap ring and tighten hand tight.
10. Remember to open the fuel shutoff valve (Lever in line with the hose) before starting the engine.

WATER SEPARATOR ELEMENT

The water separator element is a two stage filter with a special filtration/water separating media, and an expanded water reservoir providing maximum protection against water in the fuel. The recommended change interval for the water separator element is 1,000 hours. The procedure for changing the element is as follows:

1. Close the fuel shutoff valve (Lever should be perpendicular to the hose) located on the side of the Fuel Pre-Filter/Water Separator Assembly.
2. Rotate the quick change ring (located just below filter header) clockwise approximately 1/2 turn and slide it down and off of the element.
3. Grasp the element and pull down with a slight rocking motion to remove the element from the grommet post on the bottom of the filter header.

4. Slide the new element onto the grommet post on the bottom of the filter header until the element no longer easily moves up into the filter header. Now rotate the element (may take almost 1 full turn) with a slight upward pressure until the element begins to further engage the header. With the proper orientation now established apply additional pressure to seat the element in the filter header. You should feel the element “pop” into place when properly seated.

Note: The element will only go on one way. Never use excessive force when mounting the element to the header.

5. Slide the quick change ring up over the element and rotate counter clockwise until an audible click or pop is heard. If you do not hear the click you have not rotated the ring far enough and the element is not in the locked position. Another indication that the ring is in the locked position is that one set (it doesn't matter which one) of arrows located on the outside of the ring should be located directly under the air vent valve.

6. Open the fuel shutoff valve (lever in line with the hose).

7. Open the air vent valve on the front of the filter header until fuel emerges free of air bubbles and then close the air vent valve.

Note : Consult your engine operation manual for information on air -bleeding the entire fuel system.

SECONDARY FUEL FILTER

The Secondary Fuel Filter is a spin on cartridge type mount directly to the engine. Consult your engine operation manual for complete information on service intervals and element changing procedures.

COOLING SYSTEM

The cooling system of the Deutz engine needs to be checked and cleaned periodically. Consult the engine owners manual for the proper frequency and procedure.

COOLING BLOWER BELT

The following procedure should be followed to replace the cooling blower belt:

1. Allow the machine to cool.
2. Unfasten and slide the battery holder out from the welder.
3. Disconnect the negative battery cable.
4. Remove engine case side.
5. Loosen air cleaner hose clamp and detach hose.
6. Remove the engine end panel with air box and air cleaner attached for access to the engine.

7. Loosen the alternator mounting bolts and rotate the alternator towards the engine.

8. Remove the old cooling blower belt and install a new one.

9. Adjust the cold belt tension to 63-73 lbs. midway between any two pulleys.

10. Reinstall the air cleaner hose, engine case side and end panel. Reattach the negative battery cable. Slide in and refasten the battery holder.

11. Check the cooling blower belt tension after 100 hours of operation. (Follow steps 1,2,3,4,5,6,9 & 10)

BATTERY HANDLING

WARNING

GASES FROM BATTERY can explode.

- Keep sparks, flame and cigarettes away from battery.



To prevent EXPLOSION when:

- INSTALLING A NEW BATTERY - disconnect negative cable from old battery first and connect to new battery last.



- CONNECTING A BATTERY CHARGER - Remove battery from welder by disconnecting negative cable first, then positive cable and battery clamp. When reinstalling, connect negative cable last. Keep well ventilated.

- USING A BOOSTER - connect positive lead to battery first then connect negative lead to engine foot.



BATTERY ACID CAN BURN EYES AND SKIN.

- Wear gloves and eye protection and be careful when working near battery. Follow instructions printed on battery.

PREVENTING ELECTRICAL DAMAGE

1. When replacing, jumping, or otherwise connecting the battery to the battery cables, the proper polarity must be observed. Failure to observe the proper polarity could result in damage to the charging circuit. The positive (+) battery cable has a red terminal cover.

2. If the battery requires charging from an external charger, disconnect the negative battery cable first and then the positive battery cable before attaching the charger leads. Failure to do so can result in damage to the internal charger components. When reconnecting the cables, connect the positive cable first and the negative cable last.

PREVENTING BATTERY DISCHARGE

If you have an ignition switch, turn it off when engine is not running.

PREVENTING BATTERY BUCKLING

Tighten nuts on battery clamp until snug.

CHARGING THE BATTERY

When you charge, jump, replace, or otherwise connect battery cables to the battery, be sure the polarity is correct. Improper polarity can damage the charging circuit. The Commander positive (+) battery terminal has a red terminal cover.

If you need to charge the battery with an external charger, disconnect the negative cable first, then the positive cable before you attach the charger leads. After the battery is charged, reconnect the positive battery cable first and the negative cable last. Failure to do so can result in damage to the internal charger components.

Follow the instructions of the battery charger manufacturer for proper charger settings and charging time.

NAMEPLATES / WARNING DECALS MAINTENANCE

Whenever routine maintenance is performed on this machine - or at least yearly - inspect all nameplates and labels for legibility. Replace those which are no longer clear. Refer to the parts list for the replacement item number.

WELDER / GENERATOR MAINTENANCE

STORAGE

Store the Commander in clean, dry protected areas.

CLEANING

Blow out the generator and controls periodically with low pressure air. Do this at least once a week in particularly dirty areas.

BRUSH REMOVAL AND REPLACEMENT

It is normal for the brushes and slip rings to wear and darken slightly. Inspect the brushes when a generator overhaul is necessary.

WARNING

Do not attempt to polish slip rings while the engine is running.

Table D.1 Engine Maintenance Components

ITEM	MAKE	PART NUMBER
Air Cleaner Element	Donaldson AC	P181052 A302C
Cooling Blower Belt	Lincoln Gates	T13536-3 7585
Oil Filter Element	Deutz Purulator Napa Fram	1174418 PER2168 1820 PH3776
Fuel Filter Element	Deutz Purulator Napa Fram	1174423 PC42 3358 P4102
Water Separator Element	Lincoln Stanadyne	M16890-C 31572
Fuel Pre-Filter Screen	Lincoln Stanadyne	M16890-B 29575
Battery		BCI Group 34

COMMANDER 500

HOW TO USE TROUBLESHOOTING GUIDE

WARNING

Service and Repair should only be performed by Lincoln Electric Factory Trained Personnel. Unauthorized repairs performed on this equipment may result in danger to the technician and machine operator and will invalidate your factory warranty. For your safety and to avoid Electrical Shock, please observe all safety notes and precautions detailed throughout this manual.

This Troubleshooting Guide is provided to help you locate and repair possible machine malfunctions. Simply follow the three-step procedure listed below.

Step 1. LOCATE PROBLEM (SYMPTOM). Look under the column labeled “PROBLEM (SYMPTOMS)”. This column describes possible symptoms that the machine may exhibit. Find the listing that best describes the symptom that the machine is exhibiting. Symptoms are grouped into the following categories: engine problems, function problems and output problems.

Step 2. PERFORM EXTERNAL TESTS. The second column labeled “POSSIBLE AREAS OF MISADJUSTMENT(S)” lists the obvious external possibilities that may contribute to the machine symptom. Perform these tests/checks in the order listed. In general, these tests can be conducted without removing the case wrap-around cover.

Step 3. RECOMMENDED COURSE OF ACTION

If you have exhausted all of the items in step 2. Contact your Local Lincoln Authorized Field Service Facility.

CAUTION

If for any reason you do not understand the test procedures or are unable to perform the tests/repairs safely, contact your Local Lincoln Authorized Field Service Facility for technical troubleshooting assistance before you proceed.

COMMANDER 500



Observe all Safety Guidelines detailed throughout this manual

PROBLEMS (SYMPTOMS)	POSSIBLE AREAS OF MISADJUSTMENTS(S)	RECOMMENDED COURSE OF ACTION
ENGINE PROBLEMS		
Major Physical or Electrical Damage is Evident.	1. Contact your Local Lincoln Authorized Field Service Facility.	
Engine will not "crank".	1. Battery is low. Charge Battery. 2. Loose battery cable connections. Inspect, clean and tighten.	
Engine will "crank" but not start.	1. Out of fuel. Fill fuel tank. 2. Fuel shut off valve is in off position. 3. High oil temperature (Indicator light lit. Check engine cooling system. (Consult engine service dealer. 4. Low battery voltage.	Contact your Local Lincoln Authorized Field Service Facility for technical troubleshooting assistance.
Engine shuts down shortly after starting.	1. Low fuel. (Indicator light lit K1585-2 only) Add fuel. 2. Low output of battery charging alternator. (Indicator light lit) Check cooling blower belt. Replace if necessary. 3. High oil temperature (Indicator light lit). Check engine cooling system. (Consult engine service dealer.	
Battery does not stay charged.	1. Faulty battery. Replace	

 **CAUTION**

If for any reason you do not understand the test procedures or are unable to perform the tests/repairs safely, contact your Local Lincoln Authorized Field Service Facility for technical troubleshooting assistance before you proceed.

COMMANDER 500



Observe all Safety Guidelines detailed throughout this manual

PROBLEMS (SYMPTOMS)	POSSIBLE AREAS OF MISADJUSTMENTS(S)	RECOMMENDED COURSE OF ACTION
FUNCTION PROBLEMS		
Engine will not idle down to low speed.	<ol style="list-style-type: none"> 1. Idler switch in High idle position. Set switch to Auto. 2. External load on welder or auxiliary power. Remove all external loads. 	Contact your Local Lincoln Authorized Field Service Facility for technical troubleshooting assistance.
Engine will not go to high idle when attempting to weld.	<ol style="list-style-type: none"> 1. Poor work lead connection to work. Make sure work clamp is tightly connected to clean base metal. 2. "Welding Terminals" switch is in wrong position. Set to "Always On" when welding without a welding terminal control cable. Refer to Operations chapter for proper use of this switch. 	
Engine will not go to high idle when using auxiliary power.	<ol style="list-style-type: none"> 1. Auxiliary power load is less than 100 watts. Idler may not respond with less than a 100 watt load. Set Idler to "High" 	

 **CAUTION**

If for any reason you do not understand the test procedures or are unable to perform the tests/repairs safely, contact your Local Lincoln Authorized Field Service Facility for technical troubleshooting assistance before you proceed.

COMMANDER 500



Observe all Safety Guidelines detailed throughout this manual

PROBLEMS (SYMPTOMS)	POSSIBLE AREAS OF MISADJUSTMENTS(S)	RECOMMENDED COURSE OF ACTION
OUTPUT PROBLEMS		
No welding power output.	<ol style="list-style-type: none"> 1. Welding terminals switch in wrong position. Place switch in "Always On" position when welding without welding terminal control cable. Refer to Operation chapter for proper switch function. 	Contact your Local Lincoln Authorized Field Service Facility for technical troubleshooting assistance.
Welder has output and no control.	<ol style="list-style-type: none"> 1. Local/Remote switch is in wrong position. Place switch in Local position to control output at welder. Place switch in Remote position to control output remotely. Refer to Operation chapter for proper switch function. 2. Poor remote kit connection. Check connections. 3. Faulty remote kit. Replace if necessary. 	
No auxiliary power.	<ol style="list-style-type: none"> 1. Open circuit breakers. Reset breakers. If breakers keep tripping check connections to auxiliary receptacles. Also make sure load does not exceed receptacles current rating. Refer to Auxiliary Connections in the Installation and Operation chapters. 2. Faulty connections to auxiliary receptacles. Check connections. 3. Faulty auxiliary circuit wiring. 	

 **CAUTION**

If for any reason you do not understand the test procedures or are unable to perform the tests/repairs safely, contact your Local Lincoln Authorized Field Service Facility for technical troubleshooting assistance before you proceed.

COMMANDER 500



CONNECTION DIAGRAM:

COMMANDER / K691-10 / K488 / K487 SPOOL GUN CONNECTION DIAGRAM

	<h1>WARNING</h1>	
<p>ELECTRIC SHOCK can kill</p> <ul style="list-style-type: none"> Do not operate with panels open. Disconnect NEGATIVE (-) BATTERY LEAD before servicing. Do not touch electrically live parts. 	<p>MOVING PARTS can injure</p> <ul style="list-style-type: none"> Keep guards in place. Keep away from moving parts. Only qualified personnel should install, use or service this equipment. 	

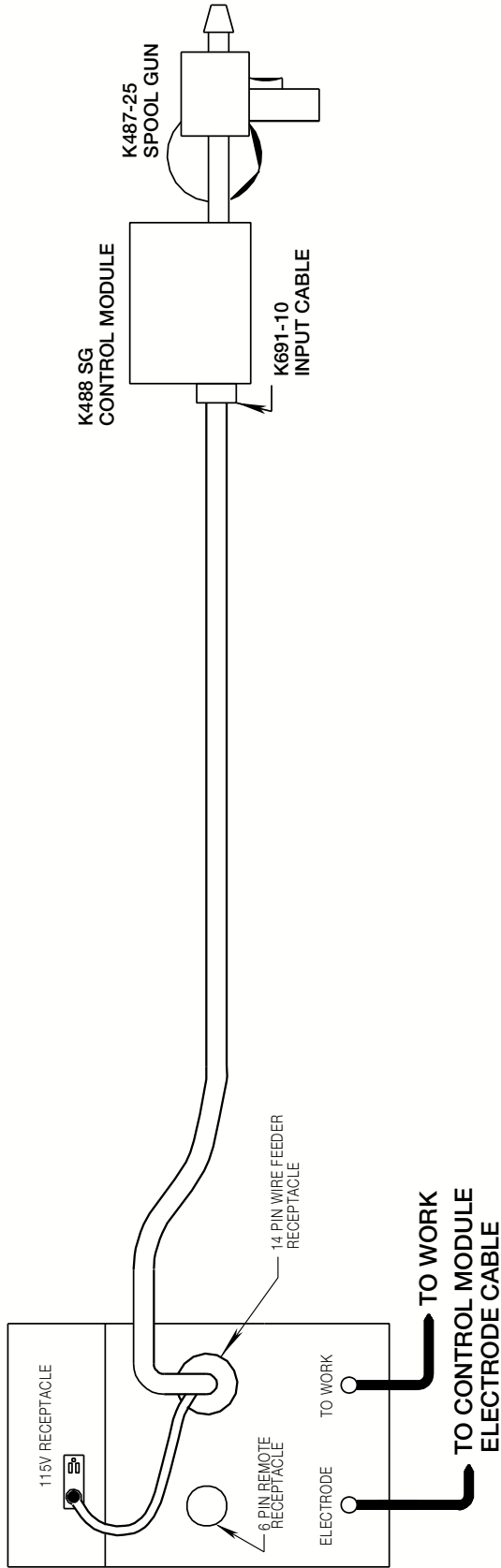

CAUTION : BE SURE THAT CONTROL MODULE MODE SLIDE SWITCH IS IN THE "LINCOLN" (CONTACT CLOSURE) POSITION BEFORE ATTEMPTING TO OPERATE CONTROL MODULE. INCORRECT SWITCH POSITION COULD RESULT IN DAMAGE TO THE CONTROL MODULE AND/OR POWER SOURCE.

ANY INCREASE OF THE HIGH IDLE ENGINE RPM BY CHANGING THE GOVERNOR SETTING OR OVERRIDING THE THROTTLE LINKAGE WILL CAUSE AN INCREASE IN THE THE AC AUXILIARY VOLTAGE. IF THIS VOLTAGE GOES OVER 140 VOLTS, WIRE FEEDER CONTROL CIRCUITS MAY BE DAMAGED. THE ENGINE GOVERNOR SETTING IS PRE-SET AT THE FACTORY - DO NOT ADJUST ABOVE RPM SPECIFICATIONS LISTED IN THE ENGINE WELDER OPERATING MANUAL.

- N.A.** WELDING CABLE MUST BE OF PROPER CAPACITY FOR THE CURRENT AND DUTY CYCLE OF IMMEDIATE AND FUTURE APPLICATIONS. SEE OPERATING MANUAL.
- N.B.** USE VOLTMETER SWITCH TO SELECT DESIRED ELECTRODE POLARITY. POSITION THE SELECTOR SWITCH TO "WIRE WELDING CV". PLACE WELDING TERMINALS SWITCH TO "REMOTELY CONTROLLED" POSITION.
- N.C.** IF OPTIONAL K857 REMOTE OUTPUT CONTROL IS CONNECTED TO 6 PIN RECEPTACLE, PLACE LOCAL REMOTE SWITCH IN "REMOTE" POSITION.
- N.D.** PLACE IDLE SWITCH IN "HIGH" IDLE POSITION.

CONNECTION DIAGRAM:

COMMANDER / K867 / K775 / LN-7 CONNECTION DIAGRAM

⚠ WARNING

ELECTRIC SHOCK can kill

- Do not operate with panels open.
- Disconnect NEGATIVE (-) BATTERY LEAD before servicing.
- Do not touch electrically live parts.

MOVING PARTS can injure

- Keep guards in place.
- Keep away from moving parts.
- Only qualified personnel should install, use or service this equipment.

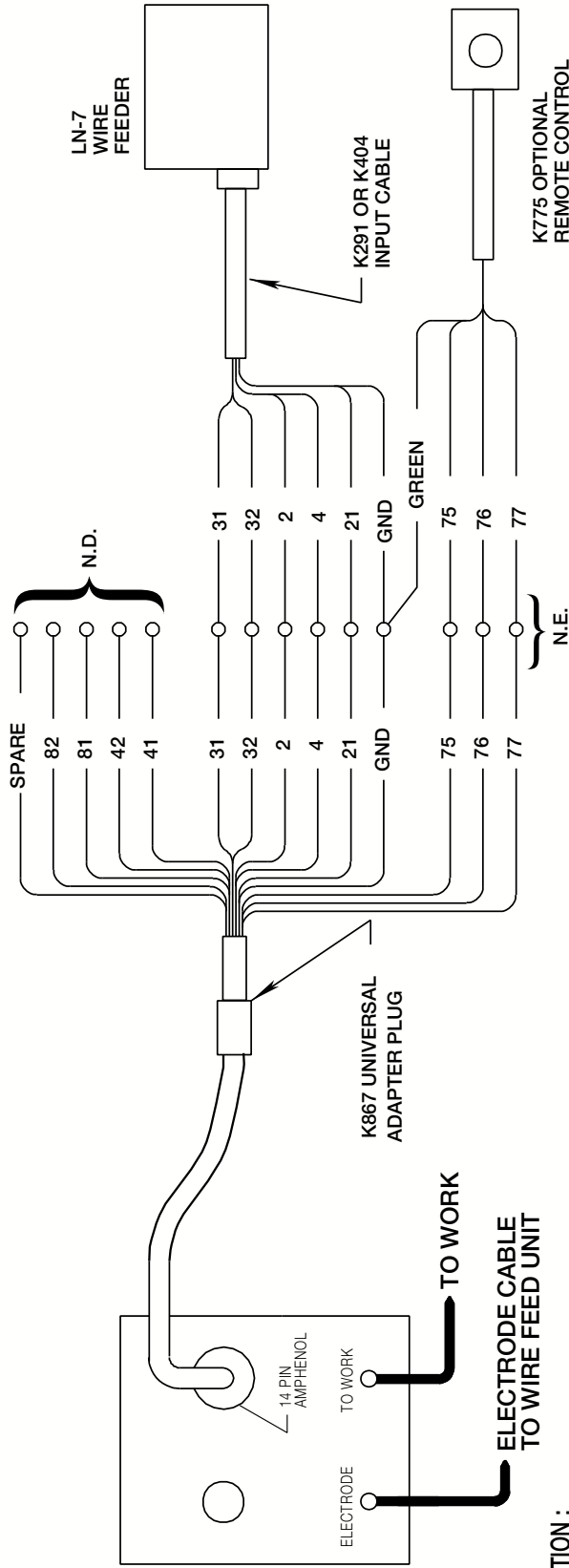

CAUTION :

ANY INCREASE OF THE HIGH IDLE ENGINE RPM BY CHANGING THE GOVERNOR SETTING OR OVERRIDING THE THROTTLE LINKAGE WILL CAUSE AN INCREASE IN THE AC AUXILIARY VOLTAGE. IF THIS VOLTAGE GOES OVER 140 VOLTS, WIRE FEEDER CONTROL CIRCUITS MAY BE DAMAGED. THE ENGINE GOVERNOR SETTING IS PRE-SET AT THE FACTORY - DO NOT ADJUST ABOVE RPM SPECIFICATIONS LISTED IN THE ENGINE WELDER OPERATING MANUAL.

N.A. WELDING CABLE MUST BE OF PROPER CAPACITY FOR THE CURRENT AND DUTY CYCLE OF IMMEDIATE AND FUTURE APPLICATIONS. SEE OPERATING MANUAL.

N.B. USE VOLTMETER SWITCH TO SELECT DESIRED ELECTRODE POLARITY. POSITION THE "SELECTOR" SWITCH TO "WIRE WELDING CV". PLACE WIRE FEEDER SWITCH TO "WIRE FEEDER WITH CONTROL CABLE POSITION."

N.C. IF OPTIONAL REMOTE OUTPUT CONTROL IS USED, PLACE LOCAL / REMOTE SWITCH IN "REMOTE" POSITION.

N.D. INSULATE EACH UNUSED LEAD INDIVIDUALLY.

N.E. SPLICE LEADS AND INSULATE.

7-18-98

S23983

CONNECTION DIAGRAM:

COMMANDER / LN-7 CONNECTION DIAGRAM

	<h2 style="margin: 0;">WARNING</h2>		<h2 style="margin: 0;">MOVING PARTS can injure</h2>
<h3 style="margin: 0;">ELECTRIC SHOCK can kill</h3>		<h3 style="margin: 0;">ELECTRIC SHOCK can kill</h3>	
<ul style="list-style-type: none"> ● Do not operate with panels open. ● Disconnect NEGATIVE (-) BATTERY LEAD before servicing. ● Do not touch electrically live parts. 		<ul style="list-style-type: none"> ● Keep guards in place. ● Keep away from moving parts. ● Only qualified personnel should install, use or service this equipment. 	

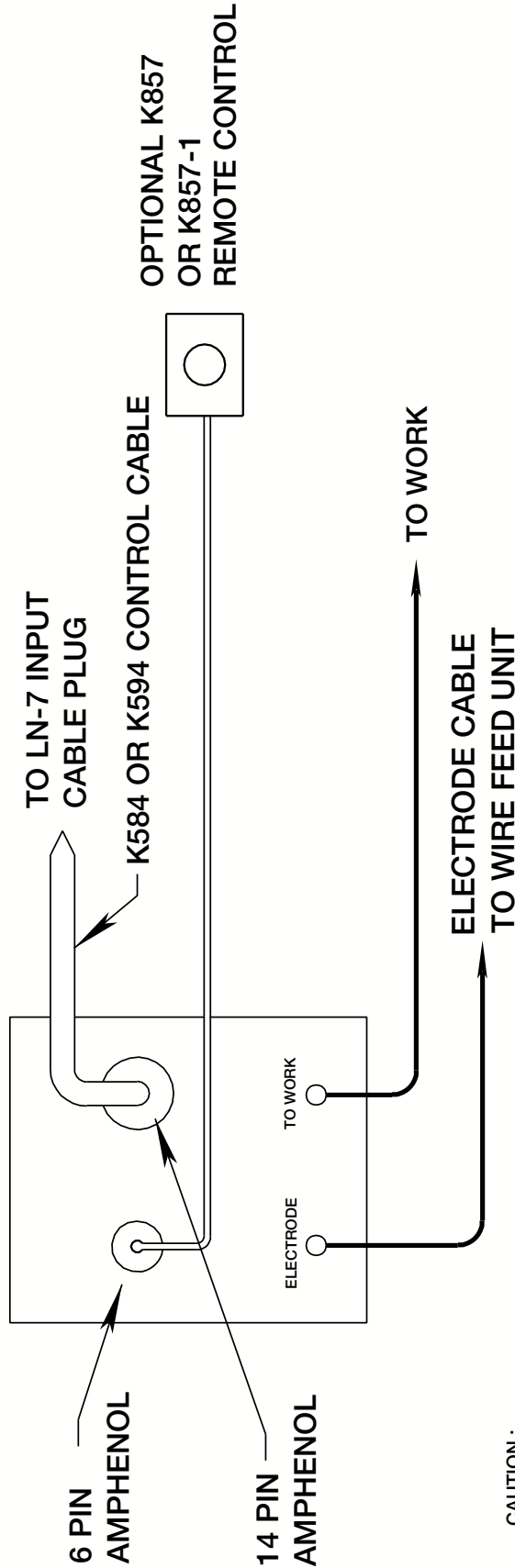

CAUTION :

ANY INCREASE OF THE HIGH IDLE ENGINE RPM BY CHANGING THE GOVERNOR SETTING OR OVERRIDING THE THROTTLE LINKAGE WILL CAUSE AN INCREASE IN THE AC AUXILIARY VOLTAGE. IF THIS VOLTAGE GOES OVER 140 VOLTS, WIRE FEEDER CONTROL CIRCUITS MAY BE DAMAGED. THE ENGINE GOVERNOR SETTING IS PRE-SET AT THE FACTORY - DO NOT ADJUST ABOVE RPM SPECIFICATIONS LISTED IN THE ENGINE WELDER OPERATING MANUAL.

N.A. USE VOLTMETER SWITCH TO SELECT DESIRED ELECTRODE POLARITY. POSITION THE SELECTOR SWITCH TO "WIRE WELDING CV".

N.B. WELDING CABLES MUST BE OF PROPER CAPACITY FOR THE CURRENT AND DUTY CYCLE OF IMMEDIATE AND FUTURE APPLICATIONS. SEE OPERATING MANUAL.

N.C. IF OPTIONAL REMOTE OUTPUT CONTROL IS USED, PLACE LOCAL REMOTE SWITCH IN "REMOTE" POSITION.

CONNECTION DIAGRAM:

COMMANDER TO K867 ADAPTER CONNECTION DIAGRAM

⚠ WARNING

ELECTRIC SHOCK can kill

- Do not operate with panels open.
- Disconnect NEGATIVE (-) BATTERY LEAD before servicing.
- Do not touch electrically live parts.

MOVING PARTS can injure

- Keep guards in place.
- Keep away from moving parts.
- Only qualified personnel should install, use or service this equipment.

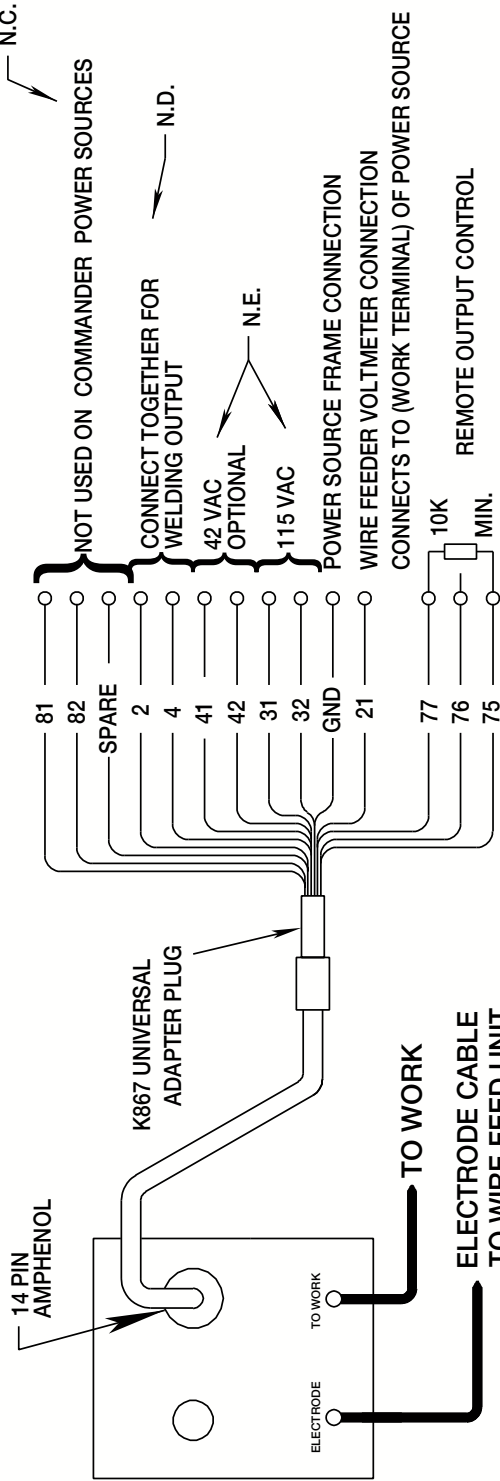

CAUTION:

ANY INCREASE OF THE HIGH IDLE ENGINE RPM BY CHANGING THE GOVERNOR SETTING OR OVERRIDING THE THROTTLE LINKAGE WILL CAUSE AN INCREASE IN THE AC AUXILIARY VOLTAGE. IF THIS VOLTAGE GOES OVER 140 VOLTS, WIRE FEEDER CONTROL CIRCUITS MAY BE DAMAGED. THE ENGINE GOVERNOR SETTING IS PRE-SET AT THE FACTORY - DO NOT ADJUST ABOVE RPM SPECIFICATIONS LISTED IN THE ENGINE WELDER OPERATING MANUAL.

N.A. WELDING CABLE MUST BE OF PROPER CAPACITY FOR THE CURRENT AND DUTY CYCLE OF IMMEDIATE AND FUTURE APPLICATIONS. SEE OPERATING MANUAL.

N.B. USE VOLTMETER SWITCH TO SELECT DESIRED ELECTRODE POLARITY.

N.C. INSULATE EACH UNUSED LEAD INDIVIDUALLY.

N.D. FOR WIRE FEEDERS THAT RETURN A SIGNAL FOR WELDING OUTPUT, USE ISOLATION RELAY TO CLOSE LEADS 2 & 4.

N.E. REFER TO POWER SOURCE INSTRUCTION MANUAL FOR MAXIMUM AUXILIARY CURRENT DRAW.

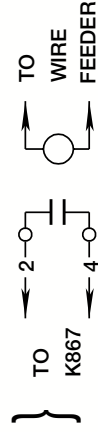

CONNECTION DIAGRAM:

COMMANDER / K867 / LN-8 CONNECTION DIAGRAM

	<h1>WARNING</h1>	
<p>ELECTRIC SHOCK can kill</p> <ul style="list-style-type: none"> Do not operate with panels open. Disconnect NEGATIVE (-) BATTERY LEAD before servicing. Do not touch electrically live parts. 	<p>MOVING PARTS can injure</p> <ul style="list-style-type: none"> Keep guards in place. Keep away from moving parts. Only qualified personnel should install, use or service this equipment. 	

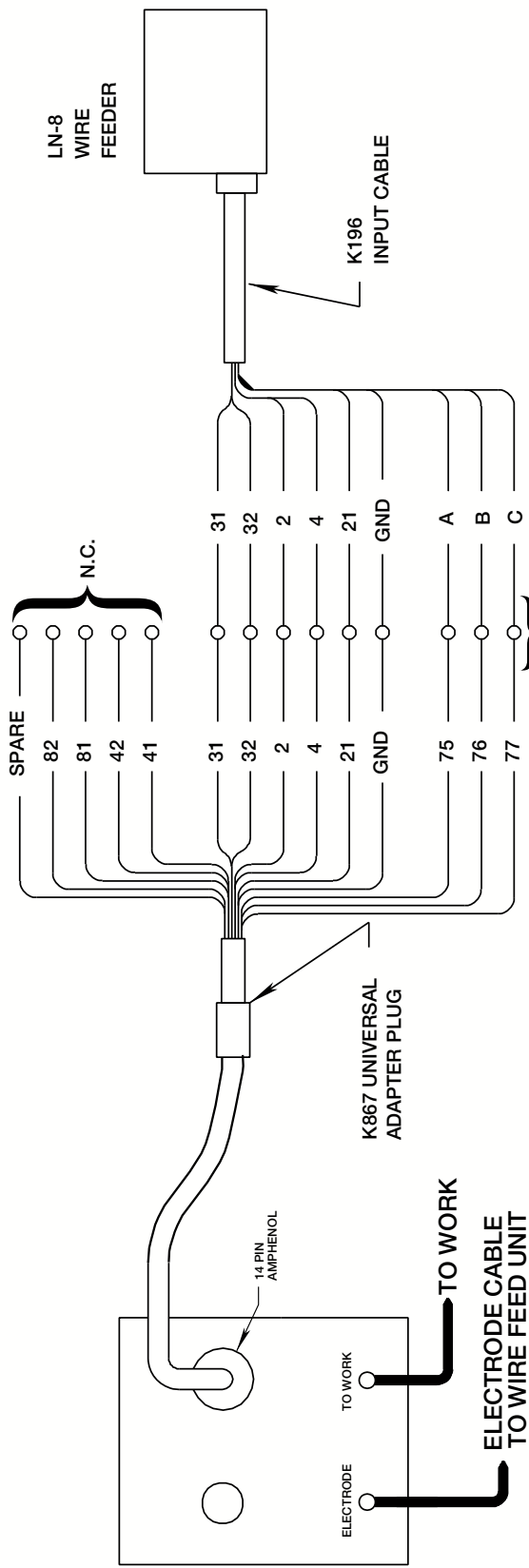

CAUTION :
 ANY INCREASE OF THE HIGH IDLE ENGINE RPM BY CHANGING THE GOVERNOR SETTING OR OVERRIDING THE THROTTLE LINKAGE WILL CAUSE AN INCREASE IN THE AC AUXILIARY VOLTAGE. IF THIS VOLTAGE GOES OVER 140 VOLTS, WIRE FEEDER CONTROL CIRCUITS MAY BE DAMAGED. THE ENGINE GOVERNOR SETTING IS PRE-SET AT THE FACTORY - DO NOT ADJUST ABOVE RPM SPECIFICATIONS LISTED IN THE ENGINE WELDER OPERATING MANUAL.

- N.A. WELDING CABLE MUST BE OF PROPER CAPACITY FOR THE CURRENT AND DUTY CYCLE OF IMMEDIATE AND FUTURE APPLICATIONS. SEE OPERATING MANUAL.
- N.B. USE VOLTMETER SWITCH TO SELECT DESIRED ELECTRODE POLARITY. POSITION THE SELECTOR SWITCH TO "WIRE WELDING CV". PLACE LOCAL / REMOTE SWITCH IN "REMOTE" POSITION.
- N.C. INSULATE EACH UNUSED LEAD INDIVIDUALLY.
- N.D. SPLICE LEADS AND INSULATE.



CONNECTION DIAGRAM:

CONNECTION DIAGRAM & INSTALLATION DETAIL
COMMANDER TO LN-23P WITH ADAPTER KIT

INSTALLATION INSTRUCTIONS

1. REPLACE EXISTING BRACKET ON ADAPTER KIT ASSEMBLY WITH THE ADAPTER BRACKET THAT HAS A HALF INCH SQUARE HOLE IN IT.
2. REMOVE THE THREE SCREWS SHOWN AND USE THEM TO FASTEN THE ADAPTER KIT ASSEMBLY ONTO THE WELDER.

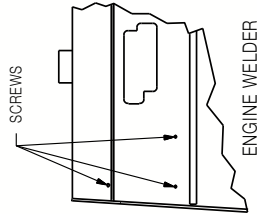

WARNING

ELECTRIC SHOCK can kill

- Do not operate with panels open.
- Disconnect NEGATIVE (-) BATTERY LEAD before servicing.
- Do not touch electrically live parts.

MOVING PARTS can injure

- Keep guards in place.
- Keep away from moving parts.
- Only qualified personnel should install, use or service this equipment.

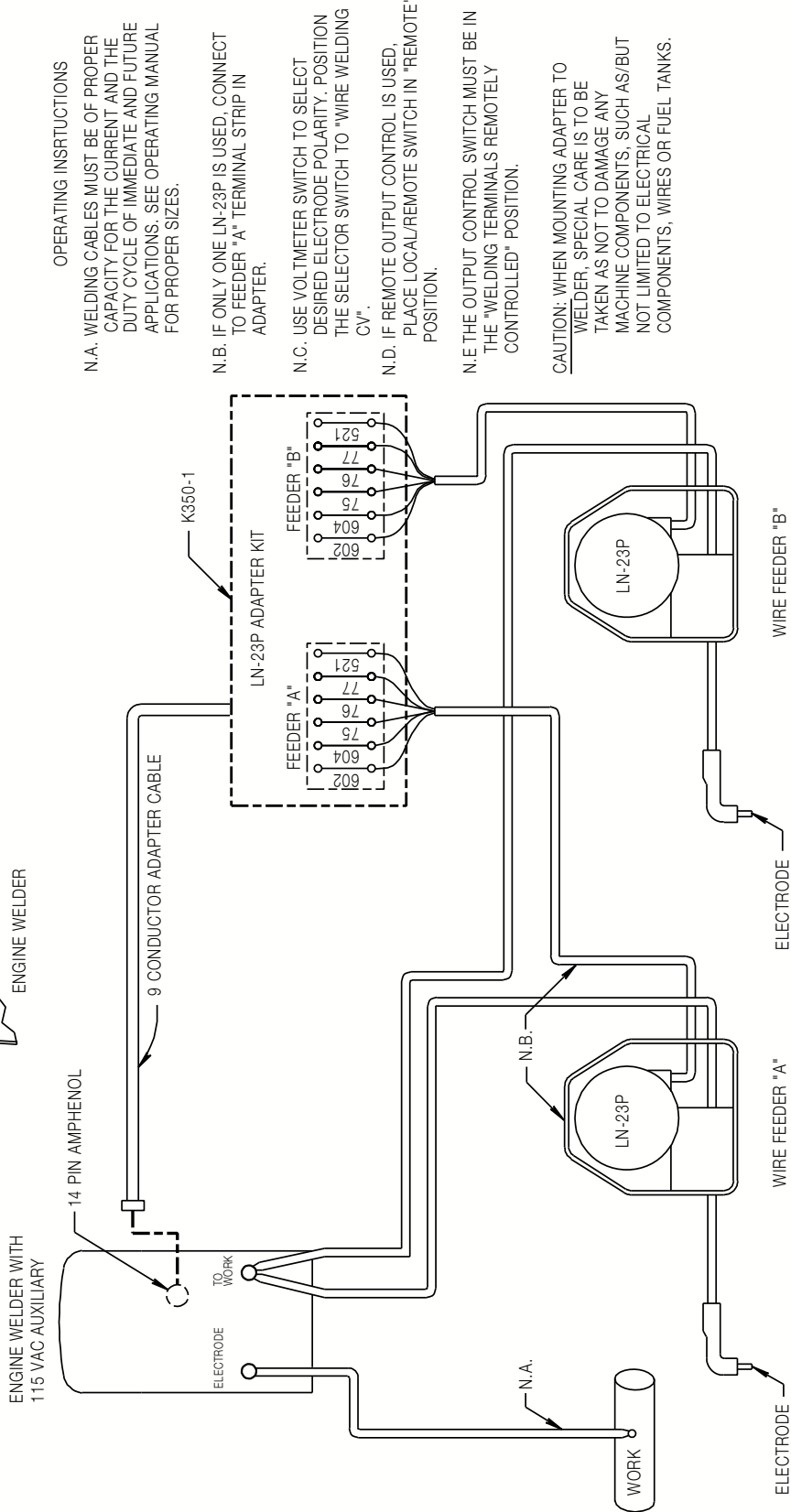

OPERATING INSTRUCTIONS

N.A. WELDING CABLES MUST BE OF PROPER CAPACITY FOR THE CURRENT AND THE DUTY CYCLE OF IMMEDIATE AND FUTURE APPLICATIONS. SEE OPERATING MANUAL FOR PROPER SIZES.

N.B. IF ONLY ONE LN-23P IS USED, CONNECT TO FEEDER "A" TERMINAL STRIP IN ADAPTER.

N.C. USE VOLTMETER SWITCH TO SELECT DESIRED ELECTRODE POLARITY. POSITION THE SELECTOR SWITCH TO "WIRE WELDING CV".

N.D. IF REMOTE OUTPUT CONTROL IS USED, PLACE LOCAL/REMOTE SWITCH IN "REMOTE" POSITION.

N.E THE OUTPUT CONTROL SWITCH MUST BE IN THE "WELDING TERMINALS REMOTELY CONTROLLED" POSITION.

CAUTION: WHEN MOUNTING ADAPTER TO WELDER, SPECIAL CARE IS TO BE TAKEN AS NOT TO DAMAGE ANY MACHINE COMPONENTS, SUCH AS/BUT NOT LIMITED TO ELECTRICAL COMPONENTS, WIRES OR FUEL TANKS.

CONNECTION DIAGRAM:

COMMANDER / LN-25 ACROSS THE ARC CONNECTION DIAGRAM WITH OPTIONAL K857 REMOTE CONTROL

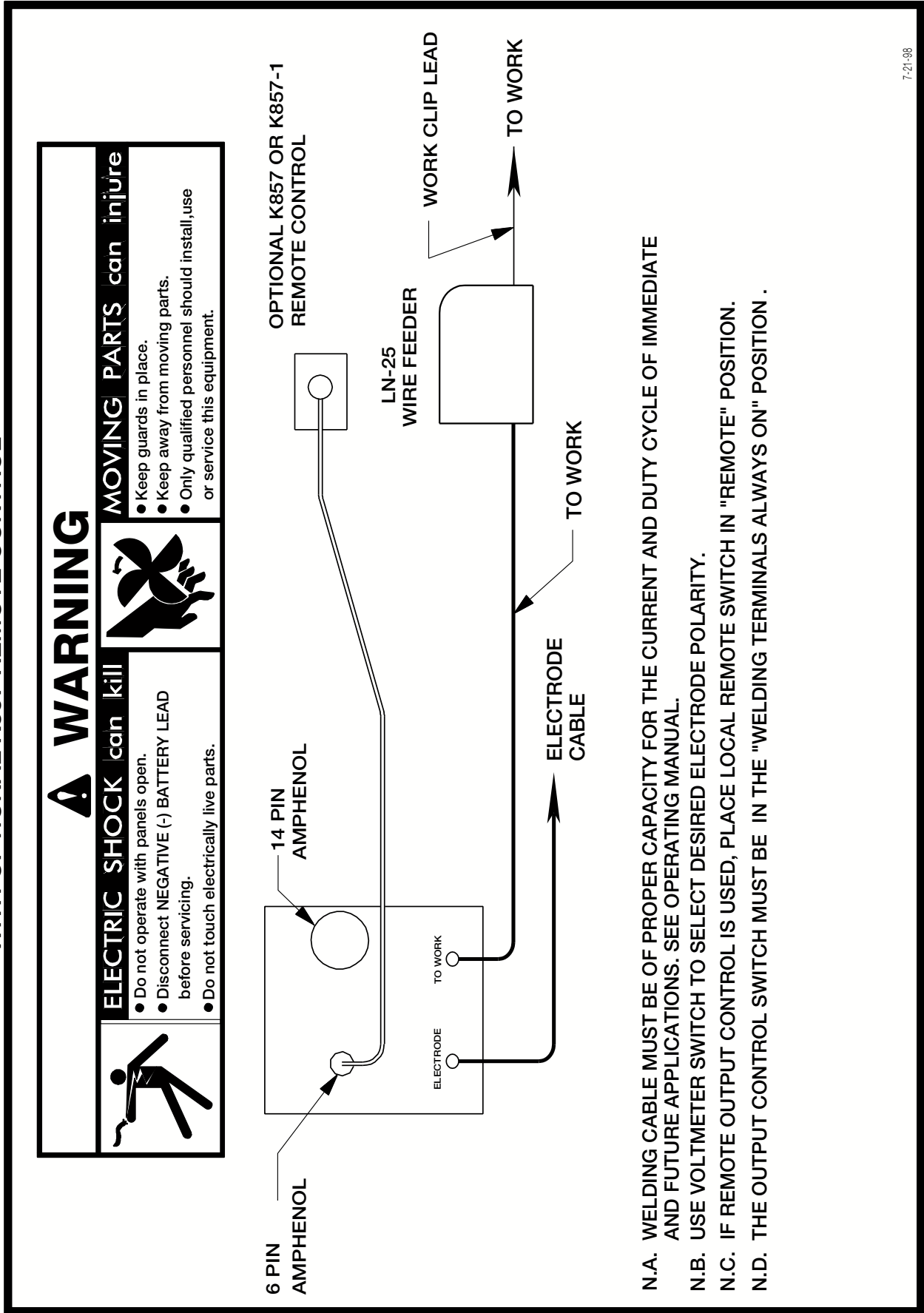

CONNECTION DIAGRAM:

COMMANDER / LN-8 CONNECTION DIAGRAM

	<p>⚠ WARNING</p> <p>ELECTRIC SHOCK can kill</p> <ul style="list-style-type: none"> • Do not operate with panels open. • Disconnect NEGATIVE (-) BATTERY LEAD before servicing. • Do not touch electrically live parts. 	<p>MOVING PARTS can injure</p> <ul style="list-style-type: none"> • Keep guards in place. • Keep away from moving parts. • Only qualified personnel should install, use or service this equipment.
---	---	--

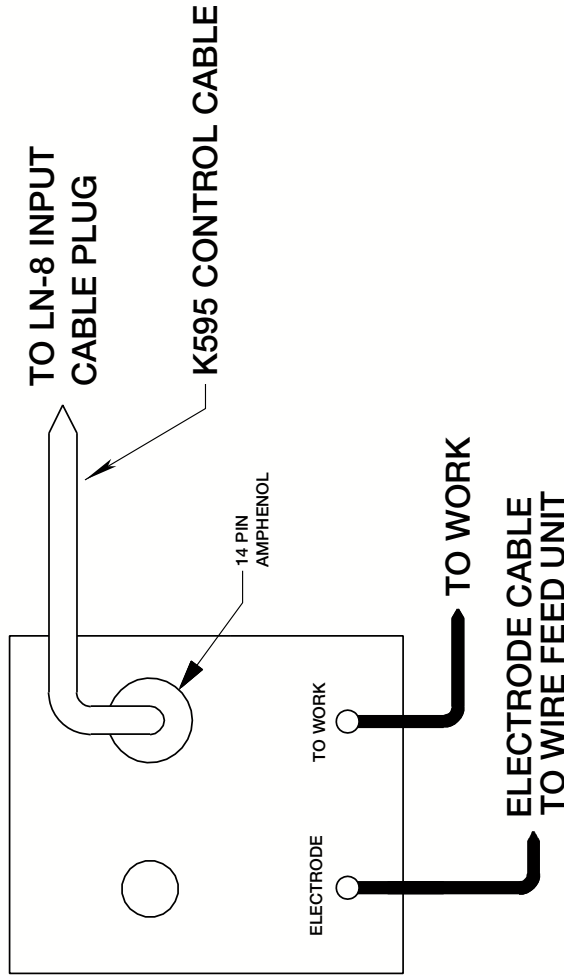

CAUTION :

ANY INCREASE OF THE HIGH IDLE ENGINE RPM BY CHANGING THE GOVERNOR SETTING OR OVERRIDING THE THROTTLE LINKAGE WILL CAUSE AN INCREASE IN THE AC AUXILIARY VOLTAGE. IF THIS VOLTAGE GOES OVER 140 VOLTS, WIRE FEEDER CONTROL CIRCUITS MAY BE DAMAGED. THE ENGINE GOVERNOR SETTING IS PRE-SET AT THE FACTORY - DO NOT ADJUST ABOVE RPM SPECIFICATIONS LISTED IN THE ENGINE WELDER OPERATING MANUAL.

- N.A. WELDING CABLES MUST BE OF PROPER CAPACITY FOR THE CURRENT AND DUTY CYCLE OF IMMEDIATE AND FUTURE APPLICATIONS. SEE OPERATING MANUAL.
- N.B. USE VOLTMETER SWITCH TO SELECT DESIRED ELECTRODE POLARITY. POSITION THE SELECTOR SWITCH TO "WIRE WELDING CV". PLACE LOCAL / REMOTE SWITCH IN "REMOTE" POSITION.

CONNECTION DIAGRAM:

COMMANDER/ LN-25 WITH L431, K433 & K432-"L" OPTION
CONNECTION DIAGRAM

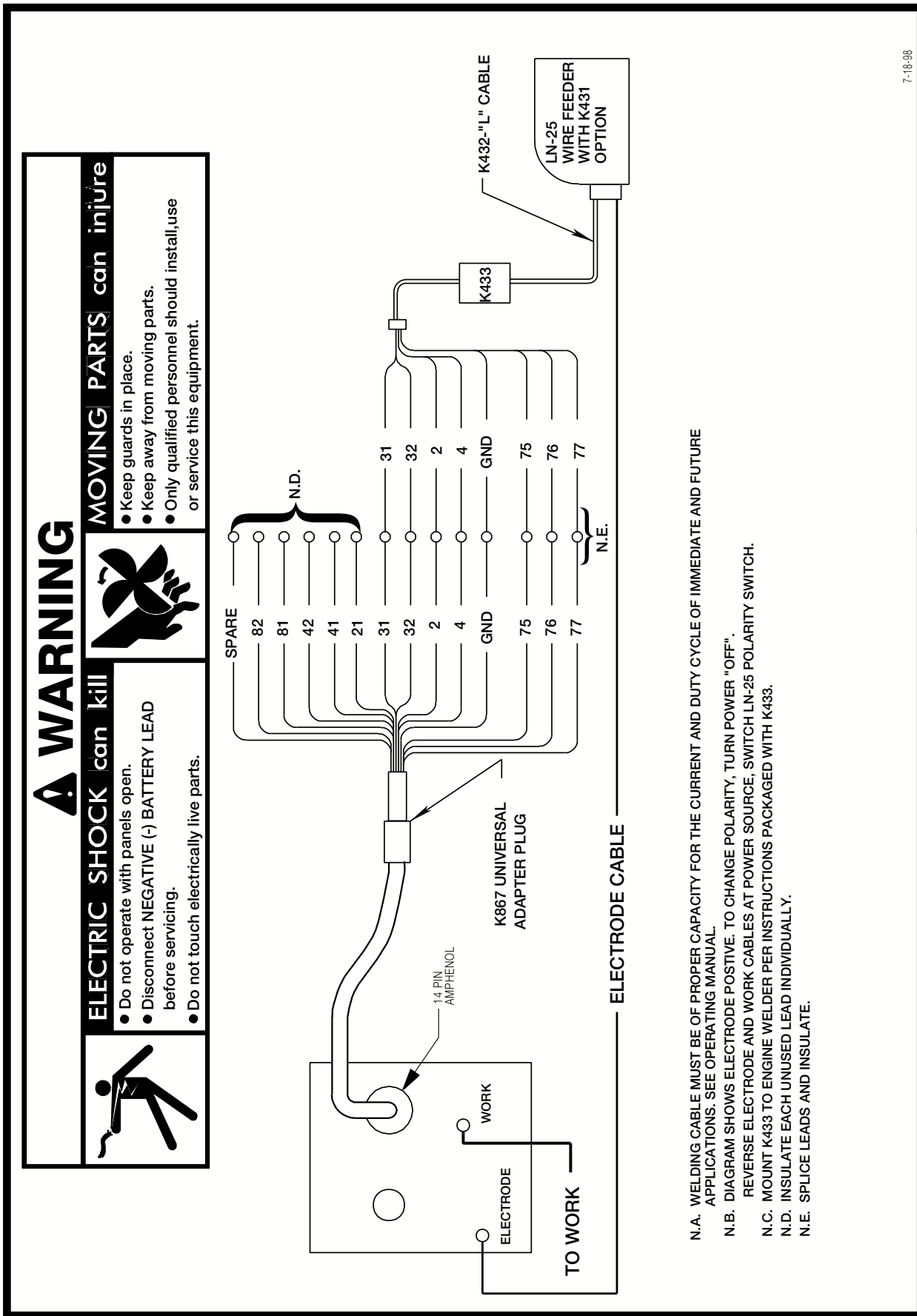

CONNECTION DIAGRAM:

COMMANDER/ LN-25 ACROSS THE ARC CONNECTION DIAGRAM WITH OPTIONAL K444-1 REMOTE CONTROL

	<h1>WARNING</h1>	
<p>ELECTRIC SHOCK can kill</p> <ul style="list-style-type: none"> Do not operate with panels open. Disconnect NEGATIVE (-) BATTERY LEAD before servicing. Do not touch electrically live parts. 	<p>MOVING PARTS can injure</p> <ul style="list-style-type: none"> Keep guards in place. Keep away from moving parts. Only qualified personnel should install, use or service this equipment. 	

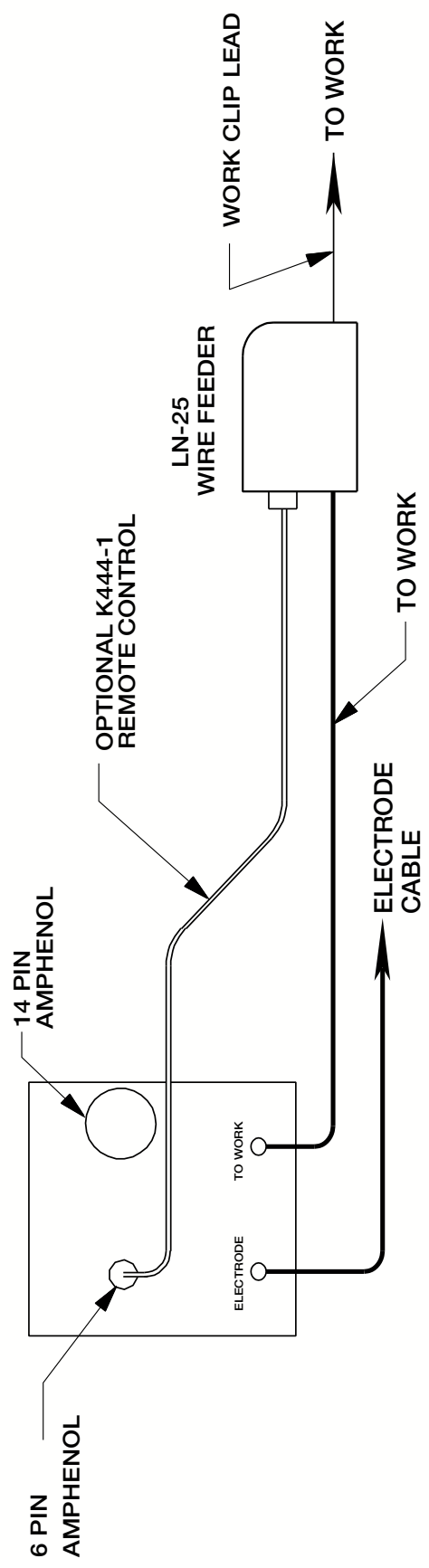

- N.A. WELDING CABLE MUST BE OF PROPER CAPACITY FOR THE CURRENT AND DUTY CYCLE OF IMMEDIATE AND FUTURE APPLICATIONS. SEE OPERATING MANUAL.
- N.B. USE VOLTMETER SWITCH TO SELECT DESIRED ELECTRODE POLARITY.
- N.C. IF REMOTE OUTPUT CONTROL IS USED, PLACE LOCAL REMOTE SWITCH IN "REMOTE" POSITION.
- N.D. THE OUTPUT CONTROL SWITCH MUST BE IN THE "WELDING TERMINALS ALWAYS ON" POSITION .

7-18-98
S23994



CONNECTION DIAGRAM:

COMMANDER / K930 TIG MODULE / CONNECTION DIAGRAM

	<h1>WARNING</h1>	
<p>ELECTRIC SHOCK can kill</p> <ul style="list-style-type: none"> Do not operate with panels open. Disconnect NEGATIVE (-) BATTERY LEAD before servicing. Do not touch electrically live parts. 		<p>MOVING PARTS can injure</p> <ul style="list-style-type: none"> Keep guards in place. Keep away from moving parts. Only qualified personnel should install, use or service this equipment.

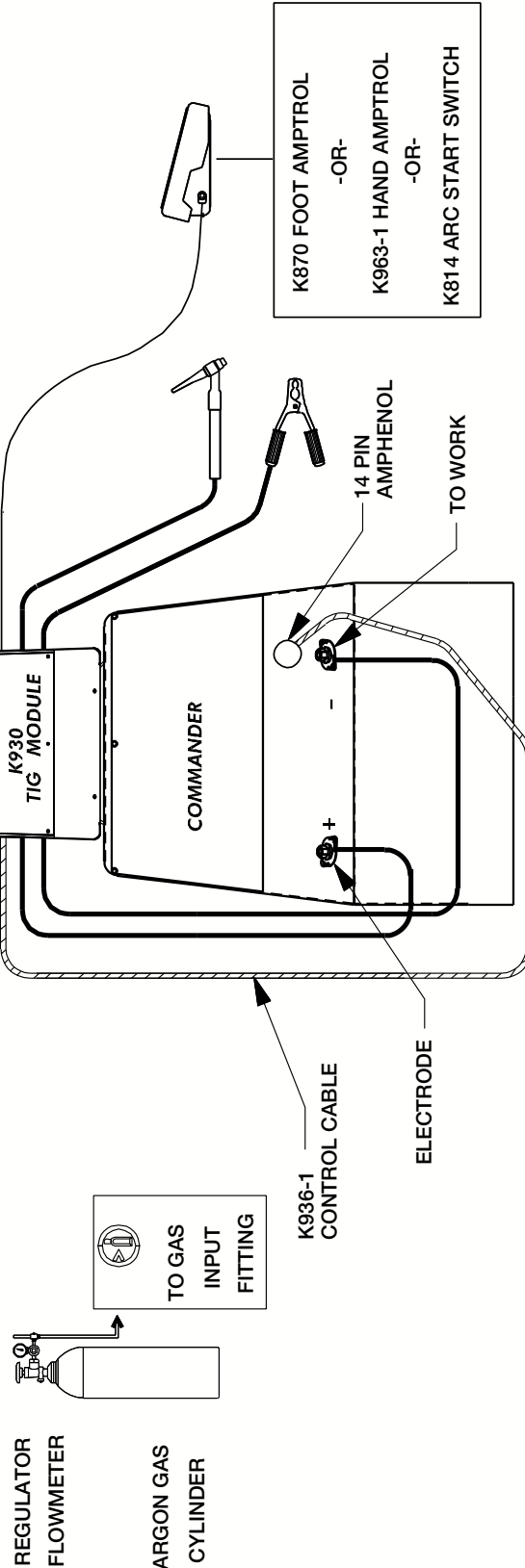

CAUTION :

ANY INCREASE OF THE HIGH IDLE ENGINE RPM BY CHANGING THE GOVERNOR SETTING OR OVERRIDING THE THROTTLE LINKAGE WILL CAUSE AN INCREASE IN THE AC AUXILIARY VOLTAGE. IF THIS VOLTAGE GOES OVER 140 VOLTS, WIRE FEEDER CONTROL CIRCUITS MAY BE DAMAGED. THE ENGINE GOVERNOR SETTING IS PRE-SET AT THE FACTORY - DO NOT ADJUST ABOVE RPM SPECIFICATIONS LISTED IN THE ENGINE WELDER OPERATING MANUAL.

N.A. WELDING CABLES MUST BE OF PROPER CAPACITY FOR THE CURRENT AND DUTY CYCLE OF IMMEDIATE AND FUTURE APPLICATIONS. SEE OPERATING MANUAL.

N.B. ATTACH ELECTRODE AND WORK LEADS OF TIG MODULE TO THE POSITIVE AND NEGATIVE STUDS OF WELDER TO SELECT DESIRED ELECTRODE POLARITY.

N.C. PLACE WELDER TERMINALS SWITCH TO " REMOTELY CONTROLLED" POSITION.

N.D. PLACE OUTPUT CONTROL SWITCH IN "REMOTE CONTROL" POSITION.

N.E. PLACE IDLER SWITCH IN "AUTO" OR "HIGH" IDLE AS DESIRED.

CONNECTION DIAGRAM:

COMMANDER / LN-742 CONNECTION DIAGRAM

	<p>⚠ WARNING</p> <p>ELECTRIC SHOCK can kill</p> <ul style="list-style-type: none"> Do not operate with panels open. Disconnect NEGATIVE (-) BATTERY LEAD before servicing. Do not touch electrically live parts. 	<p>MOVING PARTS can injure</p> <ul style="list-style-type: none"> Keep guards in place. Keep away from moving parts. Only qualified personnel should install, use or service this equipment.
---	---	--

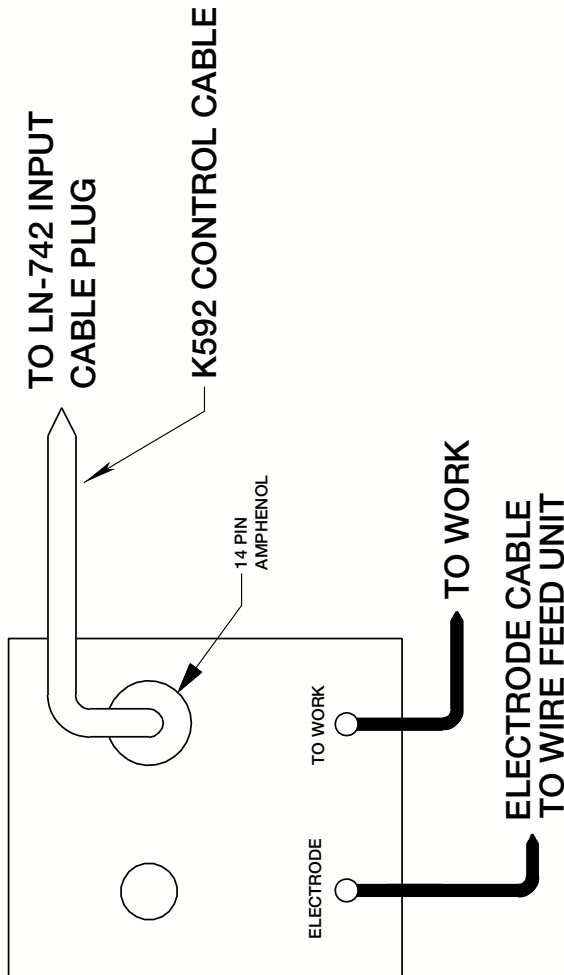

CAUTION :
 ANY INCREASE OF THE HIGH IDLE ENGINE RPM BY CHANGING THE GOVERNOR SETTING OR OVERRIDING THE THROTTLE LINKAGE WILL CAUSE AN INCREASE IN THE AC AUXILIARY VOLTAGE. IF THIS VOLTAGE GOES OVER 140 VOLTS, WIRE FEEDER CONTROL CIRCUITS MAY BE DAMAGED. THE ENGINE GOVERNOR SETTING IS PRE-SET AT THE FACTORY - DO NOT ADJUST ABOVE RPM SPECIFICATIONS LISTED IN THE ENGINE WELDER OPERATING MANUAL.

N.A. WELDING CABLES MUST BE OF PROPER CAPACITY FOR THE CURRENT AND DUTY CYCLE OF IMMEDIATE AND FUTURE APPLICATIONS. SEE OPERATING MANUAL.

N.B. USE VOLTMETER SWITCH TO SELECT DESIRED ELECTRODE POLARITY. POSITION THE SELECTOR SWITCH TO "WIRE WELDING CV". PLACE LOCAL / REMOTE SWITCH IN "REMOTE" POSITION.

N.C. REQUIRES OPTIONAL K1597-1 42VAC TRANSFORMER KIT.

A

S24609



DIMENSION PRINT

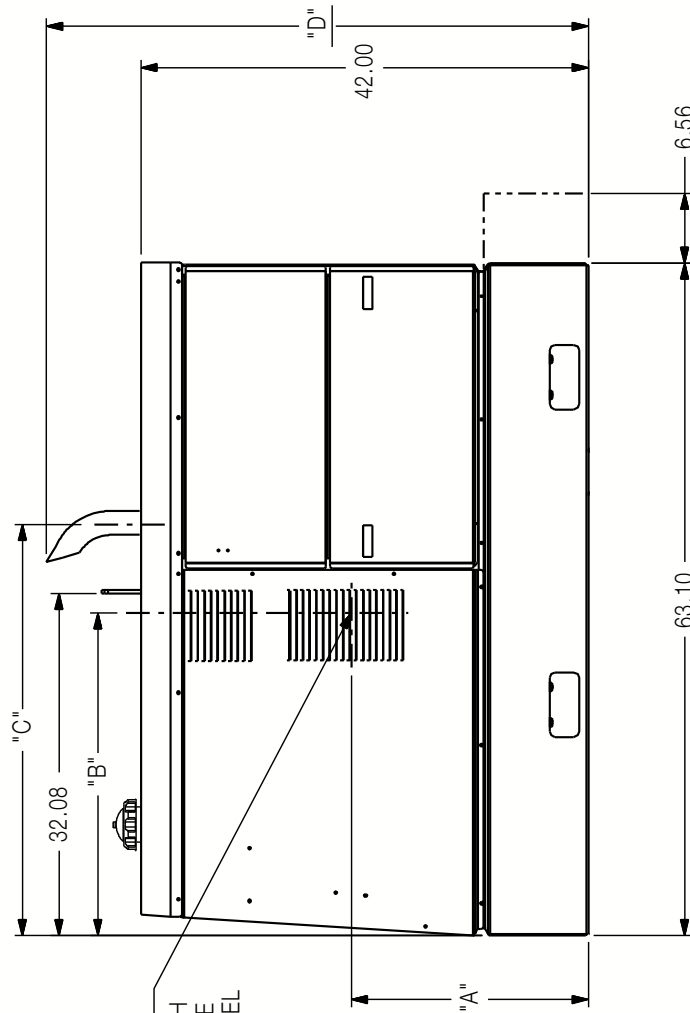
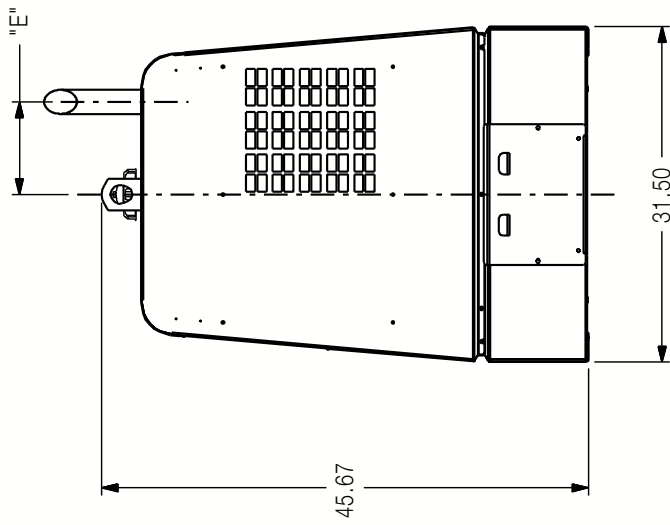

FOR BATTERY REMOVAL.

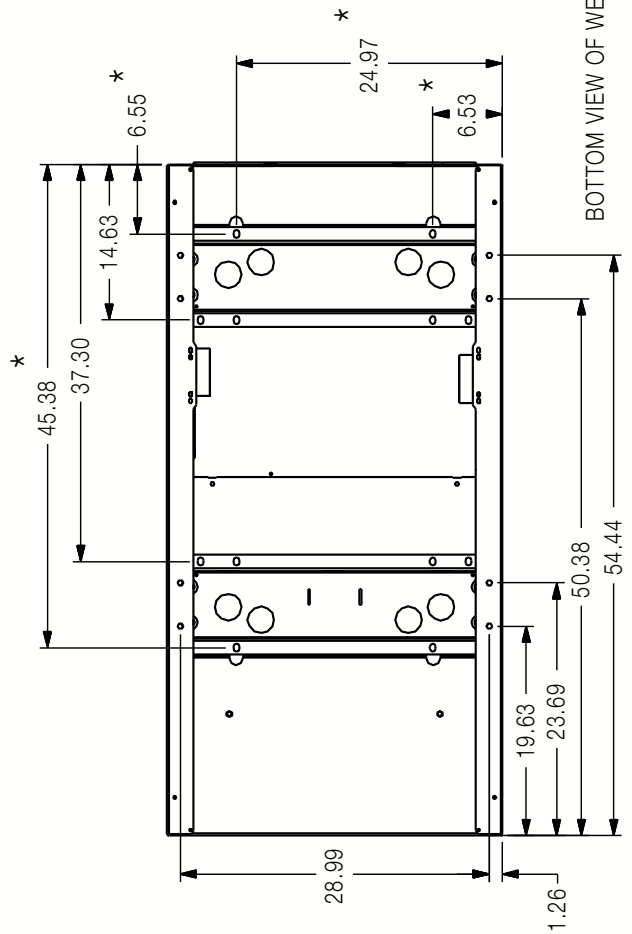

BOTTOM VIEW OF WELDER BASE.

* TRAILER MOUNTING HOLE LOCATIONS.

M18962-1	23.38	31.13	49.05	48.64	10.22
PART NO.	"A"	"B"	"C"	"D"	"E"

A
M18962

WARNING	<ul style="list-style-type: none"> ● Do not touch electrically live parts or electrode with skin or wet clothing. ● Insulate yourself from work and ground. 	<ul style="list-style-type: none"> ● Keep flammable materials away. 	<ul style="list-style-type: none"> ● Wear eye, ear and body protection.
Spanish AVISO DE PRECAUCION	<ul style="list-style-type: none"> ● No toque las partes o los electrodos bajo carga con la piel o ropa mojada. ● Aíslese del trabajo y de la tierra. 	<ul style="list-style-type: none"> ● Mantenga el material combustible fuera del área de trabajo. 	<ul style="list-style-type: none"> ● Protéjase los ojos, los oídos y el cuerpo.
French ATTENTION	<ul style="list-style-type: none"> ● Ne laissez ni la peau ni des vêtements mouillés entrer en contact avec des pièces sous tension. ● Isolez-vous du travail et de la terre. 	<ul style="list-style-type: none"> ● Gardez à l'écart de tout matériel inflammable. 	<ul style="list-style-type: none"> ● Protégez vos yeux, vos oreilles et votre corps.
German WARNUNG	<ul style="list-style-type: none"> ● Berühren Sie keine stromführenden Teile oder Elektroden mit Ihrem Körper oder feuchter Kleidung! ● Isolieren Sie sich von den Elektroden und dem Erdboden! 	<ul style="list-style-type: none"> ● Entfernen Sie brennbares Material! 	<ul style="list-style-type: none"> ● Tragen Sie Augen-, Ohren- und Körperschutz!
Portuguese ATENÇÃO	<ul style="list-style-type: none"> ● Não toque partes elétricas e electrodos com a pele ou roupa molhada. ● Isole-se da peça e terra. 	<ul style="list-style-type: none"> ● Mantenha inflamáveis bem guardados. 	<ul style="list-style-type: none"> ● Use proteção para a vista, ouvido e corpo.
Japanese 注意事項	<ul style="list-style-type: none"> ● 通電中の電気部品、又は溶材にヒフやぬれた布で触れないこと。 ● 施工物やアースから身体が絶縁されている様にして下さい。 	<ul style="list-style-type: none"> ● 燃えやすいものの側での溶接作業は絶対にしてはなりません。 	<ul style="list-style-type: none"> ● 目、耳及び身体に保護具をして下さい。
Chinese 警告	<ul style="list-style-type: none"> ● 皮肤或湿衣物切勿接触带电部件及焊条。 ● 使你自已与地面和工作件绝缘。 	<ul style="list-style-type: none"> ● 把一切易燃物品移离工作场所。 	<ul style="list-style-type: none"> ● 佩戴眼、耳及身体劳动保护用具。
Korean 위험	<ul style="list-style-type: none"> ● 전도체나 용접봉을 젖은 형갑 또는 피부로 절대 접촉치 마십시오. ● 모재와 접지를 접촉치 마십시오. 	<ul style="list-style-type: none"> ● 인화성 물질을 접근시키지 마십시오. 	<ul style="list-style-type: none"> ● 눈, 귀와 몸에 보호장구를 착용하십시오.
Arabic تحذير	<ul style="list-style-type: none"> ● لا تلمس الاجزاء التي يسري فيها التيار الكهربائي أو الألكترود بجسد الجسم أو بالملابس المبللة بالماء. ● ضع عازلا على جسمك خلال العمل. 	<ul style="list-style-type: none"> ● ضع المواد القابلة للاشتعال في مكان بعيد. 	<ul style="list-style-type: none"> ● ضع أدوات وملابس واقية على عينيك وأذنيك وجسمك.

READ AND UNDERSTAND THE MANUFACTURER'S INSTRUCTION FOR THIS EQUIPMENT AND THE CONSUMABLES TO BE USED AND FOLLOW YOUR EMPLOYER'S SAFETY PRACTICES.

SE RECOMIENDA LEER Y ENTENDER LAS INSTRUCCIONES DEL FABRICANTE PARA EL USO DE ESTE EQUIPO Y LOS CONSUMIBLES QUE VA A UTILIZAR, SIGA LAS MEDIDAS DE SEGURIDAD DE SU SUPERVISOR.

LISEZ ET COMPRENEZ LES INSTRUCTIONS DU FABRICANT EN CE QUI REGARDE CET EQUIPMENT ET LES PRODUITS A ETRE EMPLOYES ET SUIVEZ LES PROCEDURES DE SECURITE DE VOTRE EMPLOYEUR.

LESEN SIE UND BEFOLGEN SIE DIE BETRIEBSANLEITUNG DER ANLAGE UND DEN ELEKTRODENEINSATZ DES HERSTELLERS. DIE UNFALLVERHÜTUNGSVORSCHRIFTEN DES ARBEITGEBERS SIND EBENFALLS ZU BEACHTEN.

			
<ul style="list-style-type: none"> ● Keep your head out of fumes. ● Use ventilation or exhaust to remove fumes from breathing zone. 	<ul style="list-style-type: none"> ● Turn power off before servicing. 	<ul style="list-style-type: none"> ● Do not operate with panel open or guards off. 	WARNING
<ul style="list-style-type: none"> ● Los humos fuera de la zona de respiración. ● Mantenga la cabeza fuera de los humos. Utilice ventilación o aspiración para gases. 	<ul style="list-style-type: none"> ● Desconectar el cable de alimentación de poder de la máquina antes de iniciar cualquier servicio. 	<ul style="list-style-type: none"> ● No operar con panel abierto o guardas quitadas. 	Spanish AVISO DE PRECAUCION
<ul style="list-style-type: none"> ● Gardez la tête à l'écart des fumées. ● Utilisez un ventilateur ou un aspirateur pour ôter les fumées des zones de travail. 	<ul style="list-style-type: none"> ● Débranchez le courant avant l'entretien. 	<ul style="list-style-type: none"> ● N'opérez pas avec les panneaux ouverts ou avec les dispositifs de protection enlevés. 	French ATTENTION
<ul style="list-style-type: none"> ● Vermeiden Sie das Einatmen von Schweißrauch! ● Sorgen Sie für gute Be- und Entlüftung des Arbeitsplatzes! 	<ul style="list-style-type: none"> ● Strom vor Wartungsarbeiten abschalten! (Netzstrom völlig öffnen; Maschine anhalten!) 	<ul style="list-style-type: none"> ● Anlage nie ohne Schutzgehäuse oder Innenschutzverkleidung in Betrieb setzen! 	German WARNUNG
<ul style="list-style-type: none"> ● Mantenha seu rosto da fumaça. ● Use ventilação e exaustão para remover fumo da zona respiratória. 	<ul style="list-style-type: none"> ● Não opere com as tampas removidas. ● Desligue a corrente antes de fazer serviço. ● Não toque as partes elétricas nuas. 	<ul style="list-style-type: none"> ● Mantenha-se afastado das partes moventes. ● Não opere com os painéis abertos ou guardas removidas. 	Portuguese ATENÇÃO
<ul style="list-style-type: none"> ● ヒュームから頭を離すようにして下さい。 ● 換気や排煙に十分留意して下さい。 	<ul style="list-style-type: none"> ● メンテナンス・サービスに取りかかる際には、まず電源スイッチを必ず切ってください。 	<ul style="list-style-type: none"> ● パネルやカバーを取り外したまま機械操作をしないで下さい。 	Japanese 注意事項
<ul style="list-style-type: none"> ● 頭部遠離煙霧。 ● 在呼吸區使用通風或排風器除煙。 	<ul style="list-style-type: none"> ● 維修前切斷電源。 	<ul style="list-style-type: none"> ● 儀表板打開或沒有安全罩時不準作業。 	Chinese 警告
<ul style="list-style-type: none"> ● 얼굴로부터 용접가스를 멀리하십시오. ● 호흡지역으로부터 용접가스를 제거하기 위해 가스제거기나 통풍기를 사용하십시오. 	<ul style="list-style-type: none"> ● 보수전에 전원을 차단하십시오. 	<ul style="list-style-type: none"> ● 판넬이 열린 상태로 작동치 마십시오. 	Korean 위험
<ul style="list-style-type: none"> ● ابعد رأسك بعيداً عن الدخان. ● استعمل التهوية أو جهاز ضغط الدخان للخارج لكي تبعد الدخان عن المنطقة التي تتنفس فيها. 	<ul style="list-style-type: none"> ● أقطع التيار الكهربائي قبل القيام بأية صيانة. 	<ul style="list-style-type: none"> ● لا تشغيل هذا الجهاز اذا كانت الاغطية الحديدية الواقية ليست عليه. 	Arabic تحذير

LEIA E COMPREENDA AS INSTRUÇÕES DO FABRICANTE PARA ESTE EQUIPAMENTO E AS PARTES DE USO, E SIGA AS PRÁTICAS DE SEGURANÇA DO EMPREGADOR.

使う機械や溶材のメーカーの指示書をよく読み、まず理解して下さい。そして貴社の安全規定に従って下さい。

請詳細閱讀並理解製造廠提供的說明以及應該使用的銀焊材料，並請遵守貴方的有閣勞動保護規定。

이 제품에 동봉된 작업지침서를 숙지하시고 귀사의 작업자 안전수칙을 준수하시기 바랍니다.

اقرأ بتمعن وافهم تعليمات المصنع المنتج لهذه المعدات والمواد قبل استعمالها واتبع تعليمات الوقاية لصاحب العمل.



• World's Leader in Welding and Cutting Products •

• Sales and Service through Subsidiaries and Distributors Worldwide •

Cleveland, Ohio 44117-1199 U.S.A. TEL: 216.481.8100 FAX: 216.486.1751 WEB SITE: www.lincolnelectric.com