

# POWER WAVE™ AC/DC

For use with machines having Code Numbers: **10849**

**Safety Depends on You**

Lincoln arc welding and cutting equipment is designed and built with safety in mind. However, your overall safety can be increased by proper installation ... and thoughtful operation on your part. **DO NOT INSTALL, OPERATE OR REPAIR THIS EQUIPMENT WITHOUT READING THIS MANUAL AND THE SAFETY PRECAUTIONS CONTAINED THROUGHOUT.** And, most importantly, think before you act and be careful.



Date of Purchase: \_\_\_\_\_  
 Serial Number: \_\_\_\_\_  
 Code Number: \_\_\_\_\_  
 Model: \_\_\_\_\_  
 Where Purchased: \_\_\_\_\_

**ISO/IEC 60974-1**

## OPERATOR'S MANUAL



Copyright © 2002 Lincoln Global Inc.

• World's Leader in Welding and Cutting Products •  
 • Sales and Service through Subsidiaries and Distributors Worldwide •  
 Cleveland, Ohio 44117-1199 U.S.A. TEL: 216.481.8100 FAX: 216.486.1751 WEB SITE: [www.lincolnelectric.com](http://www.lincolnelectric.com)

## ⚠ WARNING

### ⚠ CALIFORNIA PROPOSITION 65 WARNINGS ⚠

Diesel engine exhaust and some of its constituents are known to the State of California to cause cancer, birth defects, and other reproductive harm.

The Above For Diesel Engines

The engine exhaust from this product contains chemicals known to the State of California to cause cancer, birth defects, or other reproductive harm.

The Above For Gasoline Engines

**ARC WELDING CAN BE HAZARDOUS. PROTECT YOURSELF AND OTHERS FROM POSSIBLE SERIOUS INJURY OR DEATH. KEEP CHILDREN AWAY. PACEMAKER WEARERS SHOULD CONSULT WITH THEIR DOCTOR BEFORE OPERATING.**

Read and understand the following safety highlights. For additional safety information, it is strongly recommended that you purchase a copy of "Safety in Welding & Cutting - ANSI Standard Z49.1" from the American Welding Society, P.O. Box 351040, Miami, Florida 33135 or CSA Standard W117.2-1974. A Free copy of "Arc Welding Safety" booklet E205 is available from the Lincoln Electric Company, 22801 St. Clair Avenue, Cleveland, Ohio 44117-1199.

**BE SURE THAT ALL INSTALLATION, OPERATION, MAINTENANCE AND REPAIR PROCEDURES ARE PERFORMED ONLY BY QUALIFIED INDIVIDUALS.**



### FOR ENGINE powered equipment.

1.a. Turn the engine off before troubleshooting and maintenance work unless the maintenance work requires it to be running.



1.b. Operate engines in open, well-ventilated areas or vent the engine exhaust fumes outdoors.



1.c. Do not add the fuel near an open flame welding arc or when the engine is running. Stop the engine and allow it to cool before refueling to prevent spilled fuel from vaporizing on contact with hot engine parts and igniting. Do not spill fuel when filling tank. If fuel is spilled, wipe it up and do not start engine until fumes have been eliminated.

1.d. Keep all equipment safety guards, covers and devices in position and in good repair. Keep hands, hair, clothing and tools away from V-belts, gears, fans and all other moving parts when starting, operating or repairing equipment.

1.e. In some cases it may be necessary to remove safety guards to perform required maintenance. Remove guards only when necessary and replace them when the maintenance requiring their removal is complete. Always use the greatest care when working near moving parts.



1.f. Do not put your hands near the engine fan. Do not attempt to override the governor or idler by pushing on the throttle control rods while the engine is running.

1.g. To prevent accidentally starting gasoline engines while turning the engine or welding generator during maintenance work, disconnect the spark plug wires, distributor cap or magneto wire as appropriate.



1.h. To avoid scalding, do not remove the radiator pressure cap when the engine is hot.



### ELECTRIC AND MAGNETIC FIELDS may be dangerous

2.a. Electric current flowing through any conductor causes localized Electric and Magnetic Fields (EMF). Welding current creates EMF fields around welding cables and welding machines

2.b. EMF fields may interfere with some pacemakers, and welders having a pacemaker should consult their physician before welding.

2.c. Exposure to EMF fields in welding may have other health effects which are now not known.

2.d. All welders should use the following procedures in order to minimize exposure to EMF fields from the welding circuit:

2.d.1. Route the electrode and work cables together - Secure them with tape when possible.

2.d.2. Never coil the electrode lead around your body.

2.d.3. Do not place your body between the electrode and work cables. If the electrode cable is on your right side, the work cable should also be on your right side.

2.d.4. Connect the work cable to the workpiece as close as possible to the area being welded.

2.d.5. Do not work next to welding power source.

Mar '95

POWER WAVE AC/DC

**LINCOLN**  
ELECTRIC



## ELECTRIC SHOCK can kill.

- 3.a. The electrode and work (or ground) circuits are electrically "hot" when the welder is on. Do not touch these "hot" parts with your bare skin or wet clothing. Wear dry, hole-free gloves to insulate hands.
- 3.b. Insulate yourself from work and ground using dry insulation. Make certain the insulation is large enough to cover your full area of physical contact with work and ground.
- In addition to the normal safety precautions, if welding must be performed under electrically hazardous conditions (in damp locations or while wearing wet clothing; on metal structures such as floors, gratings or scaffolds; when in cramped positions such as sitting, kneeling or lying, if there is a high risk of unavoidable or accidental contact with the workpiece or ground) use the following equipment:**
- Semiautomatic DC Constant Voltage (Wire) Welder.
  - DC Manual (Stick) Welder.
  - AC Welder with Reduced Voltage Control.
- 3.c. In semiautomatic or automatic wire welding, the electrode, electrode reel, welding head, nozzle or semiautomatic welding gun are also electrically "hot".
- 3.d. Always be sure the work cable makes a good electrical connection with the metal being welded. The connection should be as close as possible to the area being welded.
- 3.e. Ground the work or metal to be welded to a good electrical (earth) ground.
- 3.f. Maintain the electrode holder, work clamp, welding cable and welding machine in good, safe operating condition. Replace damaged insulation.
- 3.g. Never dip the electrode in water for cooling.
- 3.h. Never simultaneously touch electrically "hot" parts of electrode holders connected to two welders because voltage between the two can be the total of the open circuit voltage of both welders.
- 3.i. When working above floor level, use a safety belt to protect yourself from a fall should you get a shock.
- 3.j. Also see Items 6.c. and 8.



## ARC RAYS can burn.

- 4.a. Use a shield with the proper filter and cover plates to protect your eyes from sparks and the rays of the arc when welding or observing open arc welding. Headshield and filter lens should conform to ANSI Z87.1 standards.
- 4.b. Use suitable clothing made from durable flame-resistant material to protect your skin and that of your helpers from the arc rays.
- 4.c. Protect other nearby personnel with suitable, non-flammable screening and/or warn them not to watch the arc nor expose themselves to the arc rays or to hot spatter or metal.



## FUMES AND GASES can be dangerous.

- 5.a. Welding may produce fumes and gases hazardous to health. Avoid breathing these fumes and gases. When welding, keep your head out of the fume. Use enough ventilation and/or exhaust at the arc to keep fumes and gases away from the breathing zone. **When welding with electrodes which require special ventilation such as stainless or hard facing (see instructions on container or MSDS) or on lead or cadmium plated steel and other metals or coatings which produce highly toxic fumes, keep exposure as low as possible and below Threshold Limit Values (TLV) using local exhaust or mechanical ventilation. In confined spaces or in some circumstances, outdoors, a respirator may be required. Additional precautions are also required when welding on galvanized steel.**
- 5.b. Do not weld in locations near chlorinated hydrocarbon vapors coming from degreasing, cleaning or spraying operations. The heat and rays of the arc can react with solvent vapors to form phosgene, a highly toxic gas, and other irritating products.
- 5.c. Shielding gases used for arc welding can displace air and cause injury or death. Always use enough ventilation, especially in confined areas, to insure breathing air is safe.
- 5.d. Read and understand the manufacturer's instructions for this equipment and the consumables to be used, including the material safety data sheet (MSDS) and follow your employer's safety practices. MSDS forms are available from your welding distributor or from the manufacturer.
- 5.e. Also see item 1.b.

Mar '95

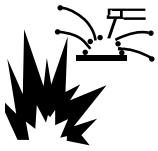

### WELDING SPARKS can cause fire or explosion.

6.a. Remove fire hazards from the welding area. If this is not possible, cover them to prevent the welding sparks from starting a fire.

Remember that welding sparks and hot materials from welding can easily go through small cracks and openings to adjacent areas. Avoid welding near hydraulic lines. Have a fire extinguisher readily available.

- 6.b. Where compressed gases are to be used at the job site, special precautions should be used to prevent hazardous situations. Refer to "Safety in Welding and Cutting" (ANSI Standard Z49.1) and the operating information for the equipment being used.
- 6.c. When not welding, make certain no part of the electrode circuit is touching the work or ground. Accidental contact can cause overheating and create a fire hazard.
- 6.d. Do not heat, cut or weld tanks, drums or containers until the proper steps have been taken to insure that such procedures will not cause flammable or toxic vapors from substances inside. They can cause an explosion even though they have been "cleaned". For information, purchase "Recommended Safe Practices for the Preparation for Welding and Cutting of Containers and Piping That Have Held Hazardous Substances", AWS F4.1 from the American Welding Society (see address above).
- 6.e. Vent hollow castings or containers before heating, cutting or welding. They may explode.
- 6.f. Sparks and spatter are thrown from the welding arc. Wear oil free protective garments such as leather gloves, heavy shirt, cuffless trousers, high shoes and a cap over your hair. Wear ear plugs when welding out of position or in confined places. Always wear safety glasses with side shields when in a welding area.
- 6.g. Connect the work cable to the work as close to the welding area as practical. Work cables connected to the building framework or other locations away from the welding area increase the possibility of the welding current passing through lifting chains, crane cables or other alternate circuits. This can create fire hazards or overheat lifting chains or cables until they fail.
- 6.h. Also see item 1.c.

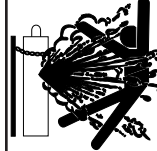

### CYLINDER may explode if damaged.

7.a. Use only compressed gas cylinders containing the correct shielding gas for the process used and properly operating regulators designed for the gas and pressure used. All hoses, fittings, etc. should be suitable for the application and maintained in good condition.

- 7.b. Always keep cylinders in an upright position securely chained to an undercarriage or fixed support.
- 7.c. Cylinders should be located:
  - Away from areas where they may be struck or subjected to physical damage.
  - A safe distance from arc welding or cutting operations and any other source of heat, sparks, or flame.
- 7.d. Never allow the electrode, electrode holder or any other electrically "hot" parts to touch a cylinder.
- 7.e. Keep your head and face away from the cylinder valve outlet when opening the cylinder valve.
- 7.f. Valve protection caps should always be in place and hand tight except when the cylinder is in use or connected for use.
- 7.g. Read and follow the instructions on compressed gas cylinders, associated equipment, and CGA publication P-1, "Precautions for Safe Handling of Compressed Gases in Cylinders," available from the Compressed Gas Association 1235 Jefferson Davis Highway, Arlington, VA 22202.



### FOR ELECTRICALLY powered equipment.

- 8.a. Turn off input power using the disconnect switch at the fuse box before working on the equipment.
- 8.b. Install equipment in accordance with the U.S. National Electrical Code, all local codes and the manufacturer's recommendations.
- 8.c. Ground the equipment in accordance with the U.S. National Electrical Code and the manufacturer's recommendations.

Mar '95

## PRÉCAUTIONS DE SÛRETÉ

Pour votre propre protection lire et observer toutes les instructions et les précautions de sûreté spécifiques qui paraissent dans ce manuel aussi bien que les précautions de sûreté générales suivantes:

### Sûreté Pour Soudage A L'Arc

1. Protégez-vous contre la secousse électrique:
  - a. Les circuits à l'électrode et à la pièce sont sous tension quand la machine à souder est en marche. Eviter toujours tout contact entre les parties sous tension et la peau nue ou les vêtements mouillés. Porter des gants secs et sans trous pour isoler les mains.
  - b. Faire très attention de bien s'isoler de la masse quand on soude dans des endroits humides, ou sur un plancher métallique ou des grilles métalliques, principalement dans les positions assis ou couché pour lesquelles une grande partie du corps peut être en contact avec la masse.
  - c. Maintenir le porte-électrode, la pince de masse, le câble de soudage et la machine à souder en bon et sûr état de fonctionnement.
  - d. Ne jamais plonger le porte-électrode dans l'eau pour le refroidir.
  - e. Ne jamais toucher simultanément les parties sous tension des porte-électrodes connectés à deux machines à souder parce que la tension entre les deux pinces peut être le total de la tension à vide des deux machines.
  - f. Si on utilise la machine à souder comme une source de courant pour soudage semi-automatique, ces précautions pour le porte-électrode s'appliquent aussi au pistolet de soudage.
2. Dans le cas de travail au dessus du niveau du sol, se protéger contre les chutes dans le cas où on reçoit un choc. Ne jamais enrouler le câble-électrode autour de n'importe quelle partie du corps.
3. Un coup d'arc peut être plus sévère qu'un coup de soleil, donc:
  - a. Utiliser un bon masque avec un verre filtrant approprié ainsi qu'un verre blanc afin de se protéger les yeux du rayonnement de l'arc et des projections quand on soude ou quand on regarde l'arc.
  - b. Porter des vêtements convenables afin de protéger la peau de soudeur et des aides contre le rayonnement de l'arc.
  - c. Protéger l'autre personnel travaillant à proximité au soudage à l'aide d'écrans appropriés et non-inflammables.
4. Des gouttes de laitier en fusion sont émises de l'arc de soudage. Se protéger avec des vêtements de protection libres de l'huile, tels que les gants en cuir, chemise épaisse, pantalons sans revers, et chaussures montantes.
5. Toujours porter des lunettes de sécurité dans la zone de soudage. Utiliser des lunettes avec écrans latéraux dans les

zones où l'on pique le laitier.

6. Eloigner les matériaux inflammables ou les recouvrir afin de prévenir tout risque d'incendie dû aux étincelles.
7. Quand on ne soude pas, poser la pince à un endroit isolé de la masse. Un court-circuit accidentel peut provoquer un échauffement et un risque d'incendie.
8. S'assurer que la masse est connectée le plus près possible de la zone de travail qu'il est pratique de le faire. Si on place la masse sur la charpente de la construction ou d'autres endroits éloignés de la zone de travail, on augmente le risque de voir passer le courant de soudage par les chaînes de levage, câbles de grue, ou autres circuits. Cela peut provoquer des risques d'incendie ou d'échauffement des chaînes et des câbles jusqu'à ce qu'ils se rompent.
9. Assurer une ventilation suffisante dans la zone de soudage. Ceci est particulièrement important pour le soudage de tôles galvanisées plombées, ou cadmiées ou tout autre métal qui produit des fumées toxiques.
10. Ne pas souder en présence de vapeurs de chlore provenant d'opérations de dégraissage, nettoyage ou pistolage. La chaleur ou les rayons de l'arc peuvent réagir avec les vapeurs du solvant pour produire du phosgène (gas fortement toxique) ou autres produits irritants.
11. Pour obtenir de plus amples renseignements sur la sûreté, voir le code "Code for safety in welding and cutting" CSA Standard W 117.2-1974.

## PRÉCAUTIONS DE SÛRETÉ POUR LES MACHINES À SOUDER À TRANSFORMATEUR ET À REDRESSEUR

1. Relier à la terre le châssis du poste conformément au code de l'électricité et aux recommandations du fabricant. Le dispositif de montage ou la pièce à souder doit être branché à une bonne mise à la terre.
2. Autant que possible, l'installation et l'entretien du poste seront effectués par un électricien qualifié.
3. Avant de faire des travaux à l'intérieur de poste, la débrancher à l'interrupteur à la boîte de fusibles.
4. Garder tous les couvercles et dispositifs de sûreté à leur place.

Mar. '93

# Thank You

for selecting a **QUALITY** product by Lincoln Electric. We want you to take pride in operating this Lincoln Electric Company product  
•• as much pride as we have in bringing this product to you!

## **Please Examine Carton and Equipment For Damage Immediately**

When this equipment is shipped, title passes to the purchaser upon receipt by the carrier. Consequently, Claims for material damaged in shipment must be made by the purchaser against the transportation company at the time the shipment is received.

Please record your equipment identification information below for future reference. This information can be found on your machine nameplate.

Model Name & Number \_\_\_\_\_

Code & Serial Number \_\_\_\_\_

Date of Purchase \_\_\_\_\_

Whenever you request replacement parts for or information on this equipment always supply the information you have recorded above.

**Read this Operators Manual completely** before attempting to use this equipment. Save this manual and keep it handy for quick reference. Pay particular attention to the safety instructions we have provided for your protection. The level of seriousness to be applied to each is explained below:

### **⚠ WARNING**

This statement appears where the information **must** be followed **exactly** to avoid **serious personal injury** or **loss of life**.

### **⚠ CAUTION**

This statement appears where the information **must** be followed to avoid **minor personal injury** or **damage to this equipment**.

	Page
<b>Installation .....</b>	<b>Section A</b>
Technical Specifications - POWER WAVE AC/DC .....	A-1
Safety Precautions.....	A-2
Select Suitable Location .....	A-2
Lifting.....	A-2
Stacking .....	A-2
Machine Grounding .....	A-2
High Frequency Protection .....	A-2
Input Connection.....	A-3
Input Fuse and Supply Wire Considerations .....	A-3
Input Voltage Changeover Procedure .....	A-3
Welding with Multiple Power Waves.....	A-4
Multiple Arc Configuration .....	A-5
Electrode and Work Cable Connections.....	A-6
Cable Inductance and its Effects on Pulse Welding.....	A-6
Voltage Sensing .....	A-7
Control Cable Connections Between Power Source and Wirefeeder.....	A-8
Control Cable Connections Between Power Sources Run in Parallel .....	A-8
Control Cable Connections between a Power Source and Phase Generator .....	A-8
Control Cable Specifications, Ethernet Connections .....	A-8
External I/O Connector.....	A-9
High Speed Gear Box .....	A-9
Dip Switch Settings and Locations.....	A-10
Control Board Dip Switch .....	A-10
Feed Head Board Dip Switch .....	A-10
DeviceNET/Gateway Board Dip Switch, .....	A-11
Multiple-Arc System Description .....	A-12
<b>Operation .....</b>	<b>Section B</b>
Safety Precautions.....	B-1
Graphic Symbols that appear on this machine or in this manual.....	B-2
Definition of Welding Terms.....	B-3
General Description .....	B-4
Recommended Processes and Equipment .....	B-4
Required Equipment.....	B-4
Limitations.....	B-4
Duty Cycle and Time Period .....	B-4
Case Front Controls .....	B-5
Constant Voltage Welding.....	B-6
Pulse Welding .....	B-7
<b>Accessories .....</b>	<b>Section C</b>
Optional Equipment.....	C-1
Factory Installed.....	C-1
Field Installed.....	C-1
<b>Maintenance .....</b>	<b>Section D</b>
Safety Precautions .....	D-1
Routine, Periodic, Calibration Specification.....	D-1
<b>Troubleshooting .....</b>	<b>Section E</b>
How to use Troubleshooting Guide .....	E-1
Troubleshooting the Power Wave / Power Feed System using the Status LED ...	E-2
Troubleshooting Guide.....	E-3 thru E-6
Error Codes for the Power Wave .....	E-7, E-8
<b>Diagrams .....</b>	<b>Section F</b>
Wiring Diagram .....	F-1
Pin, Lead Connector, Connection Diagrams, and Dimension Print.....	F-2 thru F-5
<b>Parts Lists .....</b>	<b>P392</b>

## TECHNICAL SPECIFICATIONS - POWER WAVE AC/DC (K1860-1)

INPUT AT RATED OUTPUT - THREE PHASE ONLY					
INPUT VOLTS 50/60HZ. 3 PHASE	OUTPUT CONDITIONS	INPUT CURRENT AMPS	IDLE POWER	POWER FACTOR @ RATED OUPUT	EFFICIENCY @ RATED OUPUT
460/500/575V	500A@40V.100%	31/29/25	800 Watts Max.	.95 MIN.	84%
OUTPUT					
OPEN CIRCUIT VOLTAGE	CURRENT RANGE DC	PULSE FREQUENCY	PULSE VOLTAGE RANGE	PULSE AND BACKGROUND TIME RANGE	AUXILIARY POWER (CIRCUIT BREAKER PROTECTED)
90VDC	20-500	0.15 - 1000 Hz	5 - 55 VDC	100 MICRO SEC. - 3.3 SEC.	40 VDC AT 10 AMPS 115 VAC AT 10 AMPS
PROCESS CURRENT RANGES (AC or DC)			CURRENT		
SAW / MIG / MAG FCAW Pulse			50-500 Average Amps 40-500 Average Amps 15-725 Peak Amps		
RECOMMENDED INPUT WIRE AND FUSE SIZES					
INPUT VOLTAGE / FREQUENCY 50/60HZ	TYPE 75°C COPPER WIRE IN CONDUIT AWG[IEC] SIZES (MM2)		TYPE 75°C GROUND WIRE IN CONDUIT AWG[IEC] SIZES (MM2)		TYPE 75°C (SUPER LAG) OR BREAKER SIZE (AMPS)
460V	8 (10)		10 (6)		45
500V	8 (10)		10 (6)		40
575V	10 (6)		10 (6)		35
PHYSICAL DIMENSIONS					
HEIGHT	WIDTH		DEPTH	WEIGHT	
38 in 965 mm	19 in 483 mm		33 in 838 mm	490 lbs. 222 kg.	
TEMPERATURE RANGES					
OPERATING TEMPERATURE RANGE			STORAGE TEMPERATURE RANGE		
-20°C to +40°C			-40°C to +40°C		

POWER WAVE AC/DC





## SAFETY PRECAUTIONS

Read this entire installation section before you start installation.



### WARNING

**ELECTRIC SHOCK can kill.**



- Only qualified personnel should perform this installation.

• Turn the input power OFF at the disconnect switch or fuse box before working on this equipment. Turn off the input power to any other equipment connected to the welding system at the disconnect switch or fuse box before working on the equipment.

- Do not touch electrically hot parts.
- Always connect the Power Wave grounding lug (located inside the reconnect input access door) to a proper safety (Earth) ground.

## SELECT SUITABLE LOCATION

Do not use Power Waves in outdoor environments. The Power Wave power source should not be subjected to falling water, nor should any parts of it be submerged in water. Doing so may cause improper operation as well as pose a safety hazard. The best practice is to keep the machine in a dry, sheltered area.

Do not mount the PowerWave over combustible surfaces. Where there is a combustible surface directly under stationary or fixed electrical equipment, that surface shall be covered with a steel plate at least .060" (1.6mm) thick, which shall extend not less than 5.90" (150mm) beyond the equipment on all sides.

Place the welder where clean cooling air can freely circulate in through the rear louvers and out through the case sides and bottom. Dirt, dust, or any foreign material that can be drawn into the welder should be kept at a minimum. Do not use air filters on the air intake because the air flow will be restricted. Failure to observe these precautions can result in excessive operating temperatures and nuisance shutdowns.

## LIFTING

Lift the machine by the lift bail only. The lift bail is designed to lift the power source only. Do not attempt to lift the Power Wave with accessories attached to it.

## STACKING

Power Wave AC/DC machine cannot be stacked.

## MACHINE GROUNDING

The frame of the welder must be grounded. A ground terminal marked with the symbol  $\oplus$  is located inside the reconnect/input access door for this purpose. See your local and national electrical codes for proper grounding methods.

## HIGH FREQUENCY PROTECTION

Locate the Power Wave away from radio controlled machinery.



### CAUTION

The normal operation of the Power Wave may adversely affect the operation of RF controlled equipment, which may result in bodily injury or damage to the equipment.

FIGURE A.1 - CONNECTION DIAGRAM ON CONNECTION/INPUT ACCESS DOOR

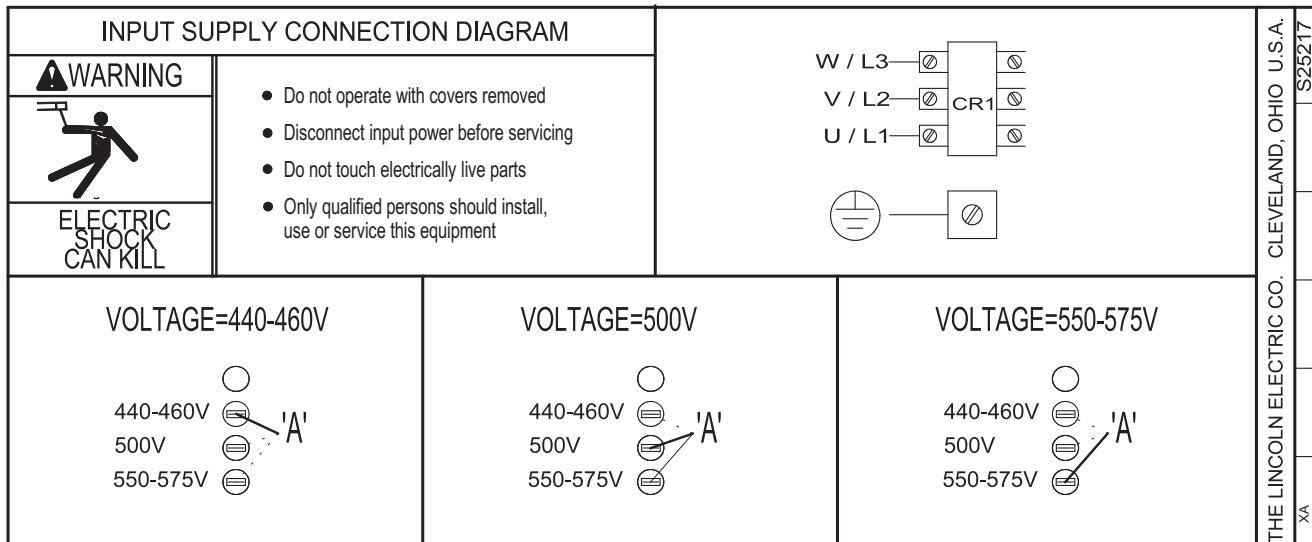

THE LINCOLN ELECTRIC CO. CLEVELAND, OHIO U.S.A.  
 S252T7  
 XA

**NOTE:** Turn main input power to the machine OFF before performing connection procedure. Failure to do so will result in damage to the machine.

## INPUT CONNECTION

### WARNING

Only a qualified electrician should connect the input leads to the Power Wave. Connections should be made in accordance with all local and national electrical codes and the connection diagram located on the inside of the reconnect/input access door of the machine. Failure to do so may result in bodily injury or death.

Use a three-phase supply line. A 1.75 inch (45 mm) diameter access hole for the input supply is located on the upper left case back next to the input access door. Connect L1, L2, L3 and ground according to the Input Supply Connection Diagram decal located on the inside of the input access door or refer to Figure A.1 .

## INPUT FUSE AND SUPPLY WIRE CONSIDERATIONS

Refer to the Technical Specifications at the beginning of this Installation section for recommended fuse and wire sizes. Fuse the input circuit with the recommended super lag fuse or delay type breakers (also called "inverse time" or "thermal/magnetic" circuit breakers). Choose an input and grounding wire size according to local or national electrical codes. Using fuses or circuit breakers smaller than recommended may result in "nuisance" shut-offs from welder inrush currents, even if the machine is not being used at high currents.

## INPUT VOLTAGE CHANGE OVER (FOR MULTIPLE INPUT VOLTAGE MACHINES ONLY)

Welders are shipped connected for the highest input voltage listed on the rating plate. To move this connection to a different input voltage, see the diagram located on the inside of the input access door.

If the Auxiliary (A) lead is placed in the wrong position, there are two possible results. If the lead is placed in a position higher than the applied line voltage, the welder may not come on at all. If the Auxiliary (A) lead is placed in a position lower than the applied line voltage, the welder will not come on, and the two circuit breakers in the reconnect area will open. If this occurs, turn off the input voltage, properly connect the (A) lead, reset the breakers, and try again.

POWER WAVE AC/DC



## WELDING WITH MULTIPLE UNSYNCHRONIZED POWER WAVES



### CAUTION

Special care must be taken when more than one Power Wave is welding unsynchronized on a single part. Arc blow and arc interference may occur or be magnified. Each power source requires a work lead to the work stud to the welding fixture. Do not combine all of the work leads into one lead. Performing welding in the direction away from the work leads. (In a synchronized multi arc system the weld should go towards the work leads to minimize arc blow). Connect all of the work sense leads from each power source to the work piece at the end of the weld, such that they are out of the path of the weld current. For additional information on work voltage sense leads see sections entitled "Voltage Sensing" and "Multiple Unsynchronized Arc Sense Lead and Work Lead Placement Guidelines".

For the best results when pulse welding, set the wire size and wire feed speed the same for all the Power Waves. When these parameters are identical, the pulsing frequency will be the same, helping to stabilize the arcs.

Every welding gun requires a separate shielding gas regulator for proper flow rate and shielding gas coverage. Do not attempt to supply shielding gas for two or more guns from only one regulator.

If an anti-spatter system is in use then each gun must have its own anti-spatter system. (See Figure A.2.)

FIGURE A.2

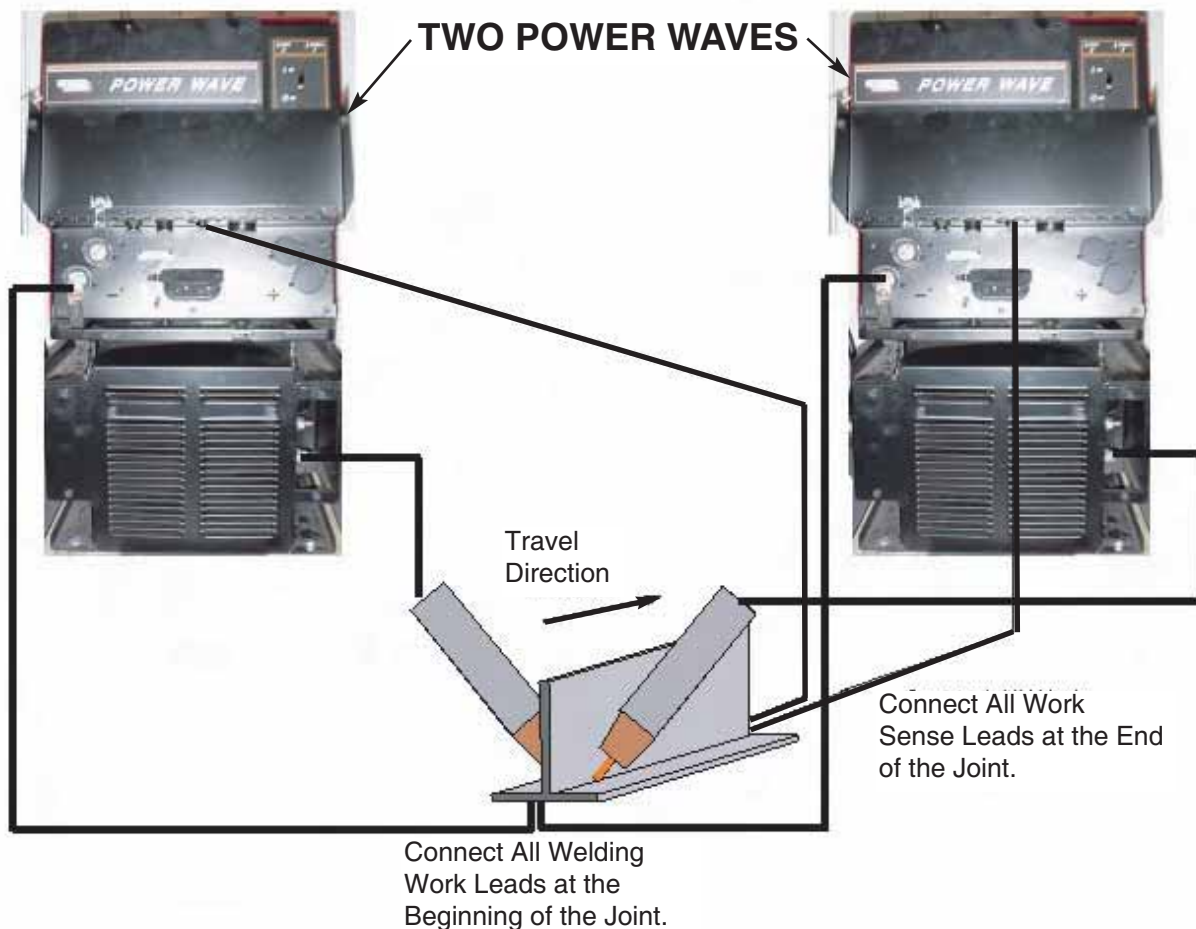

POWER WAVE AC/DC



## MULTIPLE UNSYNCHRONIZED ARC SENSE LEAD AND WORK LEAD PLACEMENT GUIDELINES

**BAD**

- fl Current flow from Arc #1 affects sense lead #2
- fl Current flow from Arc #2 affects sense lead #1
- fl Neither sense lead picks up the correct work voltage, causing starting and welding arc instability.

**BETTER**

- fl Sense #1 is only affected by weld current from Arc #1
- fl Sense #2 is only affected by weld current from Arc #2
- fl Due to voltage drops across work piece, Arc voltage may be low, causing need for deviation from standard procedures.

**BEST**

- fl Both Sense leads are out of the current paths.
- fl Both Sense leads detect arc voltage accurately.
- fl No voltage drop between Arc and Sense lead.
- fl Best starts, best arcs, most reliable results.

## ELECTRODE AND WORK CABLE CONNECTIONS

Due to the PowerWave AC/DC's ability to produce either a DC positive, DC negative or AC output the electrode and work connections do not need to be reversed for the different polarities. Additionally no DIP switch changes are required to switch between the different polarities. All of this is controlled internally by the Power Wave AC/DC. The following directions apply to all polarities:

Connect a work lead of sufficient size (Per Table 1) and length between the "work" stud (located beneath the spring loaded output cover on the front of the machine) and the work. For convenience, the work lead can be routed behind the left strain relief (under the spring loaded output cover), along the channels, and out the back of the machine. Be sure the connection to the work makes tight metal-to-metal electrical contact. The work piece connection must be firm and secure. Excessive voltage drops caused by poor work piece connections often result in unsatisfactory welding performance, especially if pulse welding is planned. To avoid interference problems with other equipment and to achieve the best possible operation, route all cables directly to the work and wire feeder. Avoid excessive lengths and do not coil excess cable.

Connect the electrode cable between the wire feeder and the "electrode" stud on the power source (located behind the cover plate on the lower right side). For convenience, the cable can be routed through the oval hole in the rear of the machine before being connected to the output terminals. Connect the other end of the electrode cable to the wire drive feed plate. Be sure the connection to the feed plate makes tight metal-to-metal electrical contact. The electrode cable should be sized according to the specifications given in (Table A.1).

### Suggested Copper Cable Sizes - 100 Duty Cycle Combined Length of Electrode and Work Cables (Table A.1)

Cable Length (ft (m))	Parallel Cables	Cable Size
0 (0) to 100 (30.4)	1	4/0 (120mm <sup>2</sup> )
100 (30.4) to 200 (60.8)	2	2/0 (70mm <sup>2</sup> )
200 (60.8) to 250 (76.2)	2	3/0 (95mm <sup>2</sup> )

When using inverter type power sources like the Power Wave, use the largest welding (electrode and work) cables that are practical. When pulsing, the pulse current can reach very high levels. Voltage drops can become excessive, leading to poor welding characteristics, if undersized welding cables are used.

**NOTE:** K1796 coaxial welding cable is recommended to reduce the cable inductance in long cable lengths. This is especially important when Pulse welding up to 350 amps.

## CABLE INDUCTANCE, AND ITS EFFECTS ON PULSE WELDING

For Pulse Welding processes, cable inductance will cause the welding performance to degrade. For the total welding loop length less than 50 feet, traditional welding cables may be used without any effects on welding performance. For the total welding loop length greater than 50 feet, the K1796 Coaxial Welding Cables are recommended.

The welding loop length is defined as the total of electrode cable length (A) + work cable length (B) + work length (C) (See Figure A.3).

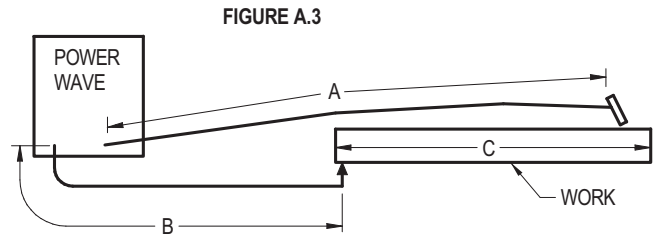

For long work piece lengths, a sliding ground should be considered to keep the total welding loop length less than 50 feet. (See Figure A.4.)

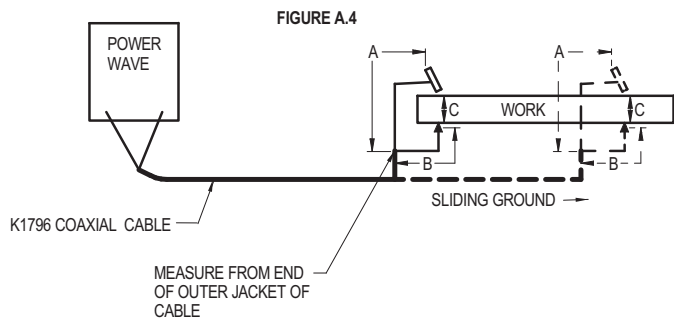

FOR A DETAILED CONNECTION DIAGRAM USING K1796 COAXIAL CABLE, SEE PAGE F-4.



### CAUTION

When pulsing, the pulse current can reach very high levels. Voltage drops can become excessive, leading to poor welding characteristics, if undersized welding cables are used.

### VOLTAGE SENSING

The best arc performance occurs when the PowerWave AC/DC has accurate data about the arc conditions. Depending upon the process, inductance within the electrode and work lead cables can influence the voltage apparent at the studs of the welder. Voltage sense leads improve the accuracy of the arc conditions and can have a dramatic effect on performance. Sense Lead Kits (K490-series) are available for this purpose.

**⚠ CAUTION**

If the voltage sensing is enabled but the sense leads are missing, improperly connected, or if the electrode polarity switch is improperly configured extremely high welding outputs may occur.

In extremely sensitive applications requiring voltage sense leads, it may be necessary to route the control cable (67 lead) and the work voltage sense lead (21 lead) away from the electrode and work welding cables. For more information regarding the placement of voltage sense leads, see the section entitled "Welding with Multiple Independent Power Waves."

The ELECTRODE sense lead (67) is built into the K1795 control cable. The WORK sense lead (21) connects to the Power Wave at the four-pin connector located underneath the output stud cover. Enable the voltage sense leads as follows:

**TABLE A.2**

Process	Electrode Voltage Sensing 67 lead *	Work Voltage Sensing 21 lead
GMAW	67 lead required	21 lead optional**
GMAW-P	67 lead required	21 lead optional**
FCAW	67 lead required	21 lead optional**
GTAW	Voltage sense at studs	Voltage sense at studs
SAW	67 lead required	21 lead optional

\* The electrode voltage 67 sense lead is part of the control cable to the wire feeder.

\*\* For consistent weld quality, work voltage sensing is recommended.

### Work Voltage Sensing

The Power Waves are shipped from the factory with the work sense lead disabled.

To use work voltage sensing, connect the (21) work voltage sense lead from the Power Wave to the work. Attach the sense lead to the work as close to the weld as practical. Enable the work voltage sensing in the Power Wave as follows:

**⚠ WARNING**

**ELECTRIC SHOCK can kill.**



- Do not touch electrically live parts or electrodes with your skin or wet clothing.
- Insulate yourself from the work and ground.

• Always wear dry insulating gloves.

1. Turn off power to the power source at the disconnect switch.

2. Remove the front cover from the power source.

3. The control board is on the left side of the power source. Locate the 8-position DIP switch and look for switch 8 of the DIP switch.

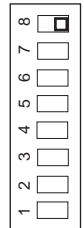

4. Using a pencil or other small object, slide the switch to the OFF position if the work sense lead is NOT connected. Conversely, slide the switch to the ON position if the work sense lead is present.



5. Replace the cover and screws. The PC board will (read) the switch at power up, and configure the work voltage sense lead appropriately.

### Electrode Voltage Sensing

Enabling or disabling electrode voltage sensing is automatically configured through software. The 67 electrode sense lead is internal to the cable to the wire feeder and always connected when a wire feeder is present.

## CONTROL CABLE CONNECTIONS BETWEEN POWER SOURCE AND WIREFEEDER

Connect the control cable between the power source and wire feeder. The wire feeder connection on the PowerWave AC/DC is located under the spring loaded output cover, on the case front. The control cable is keyed and polarized to prevent improper connect.

For convenience, the control cables can be routed behind the left or right strain relief (under the spring loaded output cover), along the channels of the Power Wave, out the back of the channels, and then to the wire feeder.



### CAUTION

Excessive voltage drops at the work piece connection often result in unsatisfactory pulse welding performance.

## CONTROL CABLE CONNECTIONS BETWEEN POWER SOURCES RUN IN PARALLEL

The connectors located on the rear of the machine are used for synchronizing the operation of multiple machines. To run machines in parallel connect the control cable (K1795 series) between power sources that are to run in parallel. The bottom (male) connector on the master connects to the top (female) connector on the slave. If needed the bottom connector on the slave machine is then used to connect to another slave machine. This connection scheme is duplicated for any additional slaves.

## CONTROL CABLE CONNECTIONS BETWEEN A POWER SOURCE AND PHASE GENERATOR

If multiple arcs need to be synchronized an external phase generator is required. The phase generator is connected to all of the master machines. A control cable (K1795 series) should be connected between the phase generator and the top (female) connector on the rear of the master machine.

## CONTROL CABLE SPECIFICATIONS

It is recommended that genuine Lincoln control cables be used at all times. Lincoln cables are specifically designed for the communication and power needs of the Power Wave / Power Feed system.



### CAUTION

The use of non-standard cables, especially in lengths greater than 25 feet, can lead to communication problems (system shutdowns), poor motor acceleration (poor arc starting) and low wire driving force (wire feeding problems). Use the shortest length of control cable possible. Do not coil excess cable as this can cause communication problems (system shutdowns).

Lincoln control cables are copper 22 conductor cable in a SO-type rubber jacket.

The K1795 series of control cables can be added in series as needed. Do not exceed more than 100 feet (30.5 m) total control cable length.

## ETHERNET CONNECTIONS

The PowerWave is equipped with an Ethernet connector, which is located under the spring loaded output cover. All Ethernet cables external to either a conduit or an enclosure should be solid, shielded with a drain, cat 5 cable. The drain should be grounded. Do not use cat 5+, cat 5E, cat 6 or stranded cable. If connection failure during welding persists reroute cables away from any other cables that carry current or other devices that would create a magnetic field. See Figure A.4a.

FIGURE A.4a

### POWER WAVE ETHERNET LAYOUT SETUP

- MAX TOTAL CABLE LENGTH IS 70 METERS (FROM POWER WAVE TO PATCH PANEL)
- SHIELDED CABLE SHOULD BE GROUNDED AT JUNCTION BOX
- REFER TO ISO / IEC 11801 FOR SPECIFICATIONS

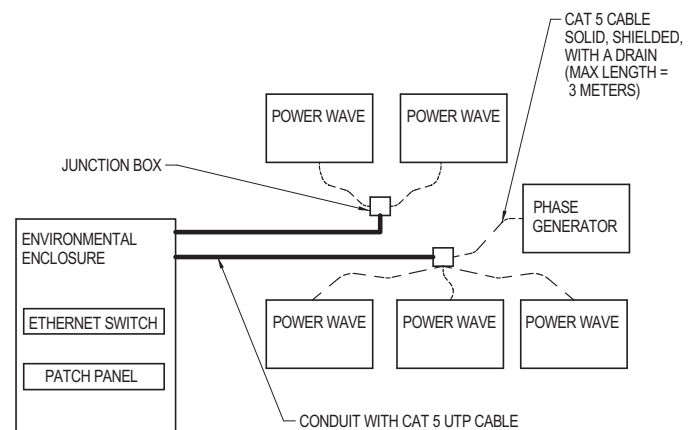

A.01  
S25560

POWER WAVE AC/DC



## EXTERNAL I/O CONNECTOR

The Power Wave is equipped with a terminal strip for making simple input signal connections. The terminal strip is located underneath the spring-loaded cover. It is divided into three groups: Trigger group, Cold Inch Group and Shutdown Group. Because the Power Wave is a 'slave' on the DeviceNet network, the Trigger and Cold Inch Groups are disabled when the DeviceNet/Gateway is active.

The shutdown group is always enabled. Shutdown2 is used for signaling low flow in the water cooler. Unused shutdowns must be jumpered. Machines from the factory come with the shutdowns already jumpered. (See Figure A.5)

FIGURE A.5

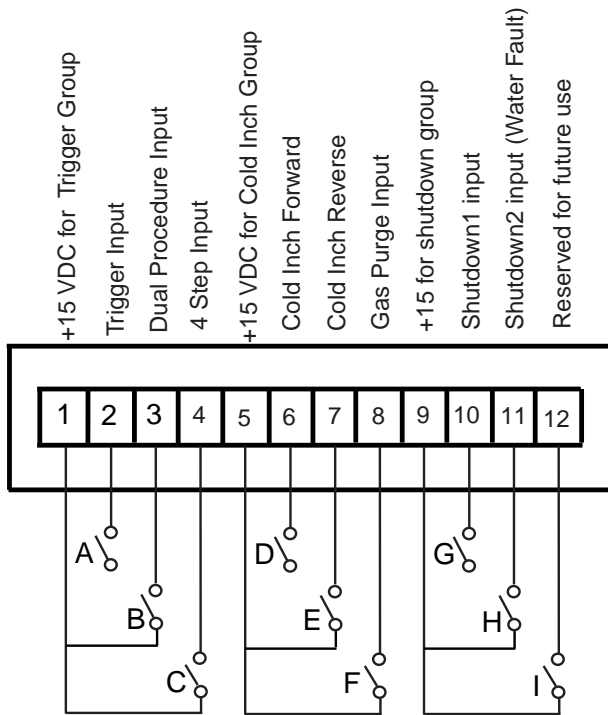

## HIGH SPEED GEAR BOX

Changing the ratio requires a gear change and a PC board DIP switch change. As shipped from the factory, the low speed (high torque) gear is configured. To change the gear ratio see the Wire Feeder Instruction Manual. The High/Low DIP switch code on Wire Drive PC board can be set as follows:

### ⚠ WARNING

#### ELECTRIC SHOCK can kill.



- Do not touch electrically live parts or electrodes with your skin or wet clothing.
- Insulate yourself from the work and ground.

- Always wear dry insulating gloves.

### ⚠ WARNING

1. Turn off power to the power source at the disconnect switch.
2. Remove the front cover from the power source.
3. The wire feed head board is on the right side of the power source. Locate the 8-position DIP switch and look for position 8 of the DIP switch.
4. Using a pencil or other small object, slide the switch to the OFF position, when the low speed gear is installed. Conversely, slide the switch to the ON position when the high speed gear is installed.
5. Replace the cover and screws. The PC board will "read" the switch at power up, automatically adjusting all control parameters for the speed range selected

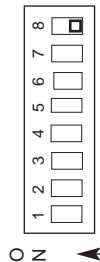



**DIP Switch Settings and Locations**

DIP switches on the P.C. Boards allow for custom configuration of the Power Wave. To access the DIP switches:

**⚠ WARNING**

- Turn off power at the disconnect switch.
- Remove the top four screws securing the front access panel.
- Loosen, but do not completely remove, the bottom two screws holding the access panel.
- Open the access panel, allowing the weight of the panel to be carried by the bottom two screws. Make sure to prevent the weight of the access panel from hanging on the harness.
- Adjust the DIP switches as necessary.
- Replace the panel and screws, and restore power.

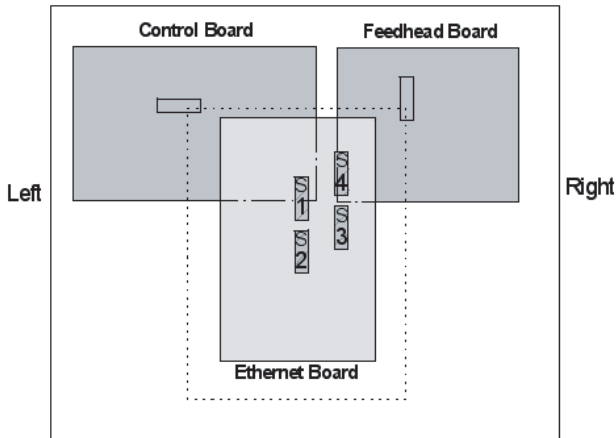

**FEED HEAD BOARD DIP SWITCH:**

Switch	Description	Comments
1	Object Instance LSB (see table A.3)	Used for ArcLink Configuration
2	Object Instance MSB (see table A.3)	
3	Equipment Group 1 Select	
4	Equipment Group 2 Select	
5	Equipment Group 3 Select	
6	Equipment Group 4 Select	
7	off Electrode polarity positive (default)	Used for configuring electrode polarity (See Electrode and Work Cable Connection in this Section)
	on Electrode polarity negative	<b>No changes required for Power Wave AC/DC</b>
8	off Low speed gear (default)	Used for configuring wirefeeder gear ratio (see High Speed Gear Box in this Section)
	on High speed gear	

**ETHERNET BOARD DIP SWITCH:**

**Bank S1**

Switch	Description	Comments
1	Object Instance LSB (see table A.3)	Used for ArcLink Configuration
2	Object Instance MSB (see table A.3)	
3	Equipment Group 1 Select	
4	Equipment Group 2 Select	
5	Equipment Group 3 Select	
6	Equipment Group 4 Select	
7	Reserved for future use	
8	Reserved for future use	

**Bank S2:**

Switch	Description	Comments
1	DeviceNet Baud Rate (See Table A.4)	Used for DeviceNet Configuration
2		
3		
4		
5	DeviceNet Mac ID (See Table A.5)	
6		
7		
8		

**CONTROL BOARD DIP SWITCH**

Switch	Description	Comments
1	Object Instance LSB (see table A.3)	Used for ArcLink configuration
2	Object Instance MSB (see table A.3)	
3	Equipment Group 1 Select	
4	Equipment Group 2 Select	
5	Equipment Group 3 Select	
6	Equipment Group 4 Select	
7	Reserved for future use	
8	off work sense lead not connected	Used for configuring work sense lead (See Work Voltage Sensing in Section A)
	on work sense lead connected	

**DeviceNet Baud Rate:**

switch 1	switch 2	Baud rate
off	off	125K
on	off	250K
off	on	500K
on	on	Programmable value

**TABLE A.4**

**OBJECT INSTANCE**

switch 2	switch 1	Instance
off	off	0 (default)
off	on	1
on	off	2
on	on	3

**TABLE A.3**

## DEVICENET MAC ID

TABLE A.5

Mac I.D.	Switch 8	Switch7	Switch6	Switch5	Switch4	Switch 3	
0	0	0	0	0	0	0	Software Selectable
1	0	0	0	0	0	1	
2	0	0	0	0	1	0	
3	0	0	0	0	1	1	
4	0	0	0	1	0	0	
5	0	0	0	1	0	1	
6	0	0	0	1	1	0	
7	0	0	0	1	1	1	
8	0	0	1	0	0	0	
9	0	0	1	0	0	1	
10	0	0	1	0	1	0	
11	0	0	1	0	1	1	
12	0	0	1	1	0	0	
13	0	0	1	1	0	1	
14	0	0	1	1	1	0	
15	0	0	1	1	1	1	
16	0	1	0	0	0	0	
17	0	1	0	0	0	1	
18	0	1	0	0	1	0	
19	0	1	0	0	1	1	
20	0	1	0	1	0	0	
21	0	1	0	1	0	1	
22	0	1	0	1	1	0	
23	0	1	0	1	1	1	
24	0	1	1	0	0	0	
25	0	1	1	0	0	1	
26	0	1	1	0	1	0	
27	0	1	1	0	1	1	
28	0	1	1	1	0	0	
29	0	1	1	1	0	1	
30	0	1	1	1	1	0	
31	0	1	1	1	1	1	
32	1	0	0	0	0	0	
33	1	0	0	0	0	1	
34	1	0	0	0	1	0	
35	1	0	0	0	1	1	
36	1	0	0	1	0	0	
37	1	0	0	1	0	1	
38	1	0	0	1	1	0	
39	1	0	0	1	1	1	
40	1	0	1	0	0	0	
41	1	0	1	0	0	1	
42	1	0	1	0	1	0	
43	1	0	1	0	1	1	
44	1	0	1	1	0	0	
45	1	0	1	1	0	1	
46	1	0	1	1	1	0	
47	1	0	1	1	1	1	
48	1	1	0	0	0	0	
49	1	1	0	0	0	1	
50	1	1	0	0	1	0	
51	1	1	0	0	1	1	
52	1	1	0	1	0	0	
53	1	1	0	1	0	1	
54	1	1	0	1	1	0	
55	1	1	0	1	1	1	
56	1	1	1	0	0	0	
57	1	1	1	0	0	1	
58	1	1	1	0	1	0	
59	1	1	1	0	1	1	
60	1	1	1	1	0	0	
61	1	1	1	1	0	1	
62	1	1	1	1	1	0	Default Setting

POWER WAVE AC/DC



Bank S3 and S4

Configuring the DIP Switches on the Ethernet-Gateway Board

MASTER WITH EXTERNAL PULSE GENERATOR

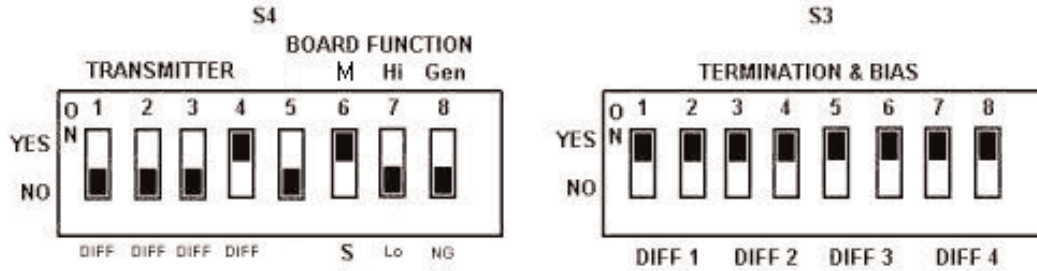

MASTER WITH INTERNAL PULSE GENERATOR

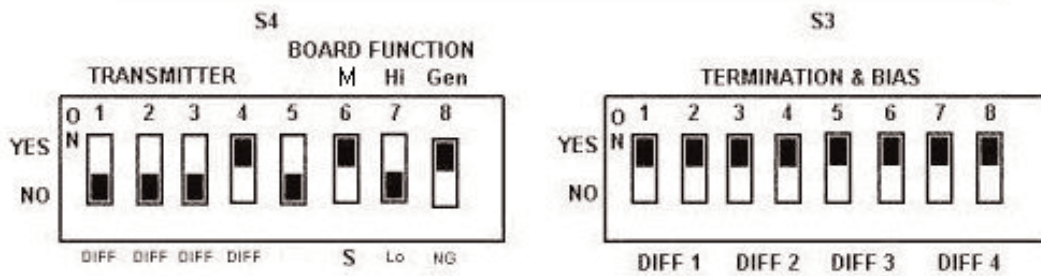

SLAVE

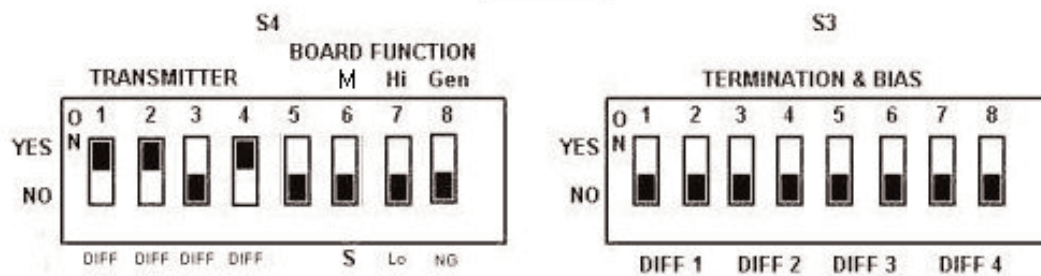

PULSE GENERATOR

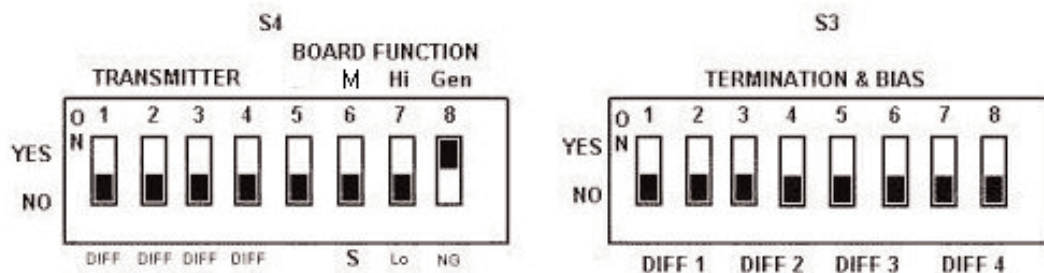

## MULTI-ARC SYSTEM DESCRIPTION

The following is a general description of how the PowerWave AC/DC can be configured in a multi-arc set-up.

Each welding arc may be driven by one machine or up to four machines connected in parallel. The hardware for the power source has been designed so that the power source can either operate as a master or a slave. A few DIP switches must be configured properly to set the machine's identity. Each power source has a rating of 500 amps average current, with a peak current of 725 amps. So, four machines are capable of driving 2000 amps of output current with up to 2900 amps of peak current available. Each arc must have one power source designated as the master. If only one machine is required for an arc, then it must be set up as the master. The master power source controls the AC switching for the arc. The slaves respond to what the master wants

Due to the flexibility of the platform the configuration may vary. A typical subarc system will consist of four welding arcs, which require ten power sources and one synchronous generator. Arc # 1 & #2 will be three machines in parallel. Arc #3 & #4 will be two machines connected in parallel (each individual machine is connected to the ethernet hub).

The PC will function as the control center for the AC/DC system as well as the user interface. The Ethernet hub splits the Ethernet port from the PC to all the power sources and the phase generator. The PC will act to coordinate the welding sequence of the multiple machines.

One machine will be designated the master, with the rest of the machines connected in parallel considered slaves. The master can generate it's own AC frequency or it can use an external signal as a reference. An external Phase Generator provides the means to synchronize the AC wave shape between multiple arcs. The phase angle between arcs can be adjusted to reduce "Arc Blow" and other welding related issues. An external phase control signal is required to keep the separate wave shapes synchronized with each other

An Ethernet-Gateway board can be used as the external Phase Generator. An Ethernet-Gateway PC board that can be configured to generate four phase signals onto four differential I/O lines. The phase signals can then be used to synchronize the four different arcs to a common carrier frequency. The frequency can range from 10 hertz to 300 hertz, with the most practical range being from 50 to 100 hertz. It may be desirable that sync signals 2, 3, or 4 are some multiple of the first signal. The frequency and phase shift are controlled by software.

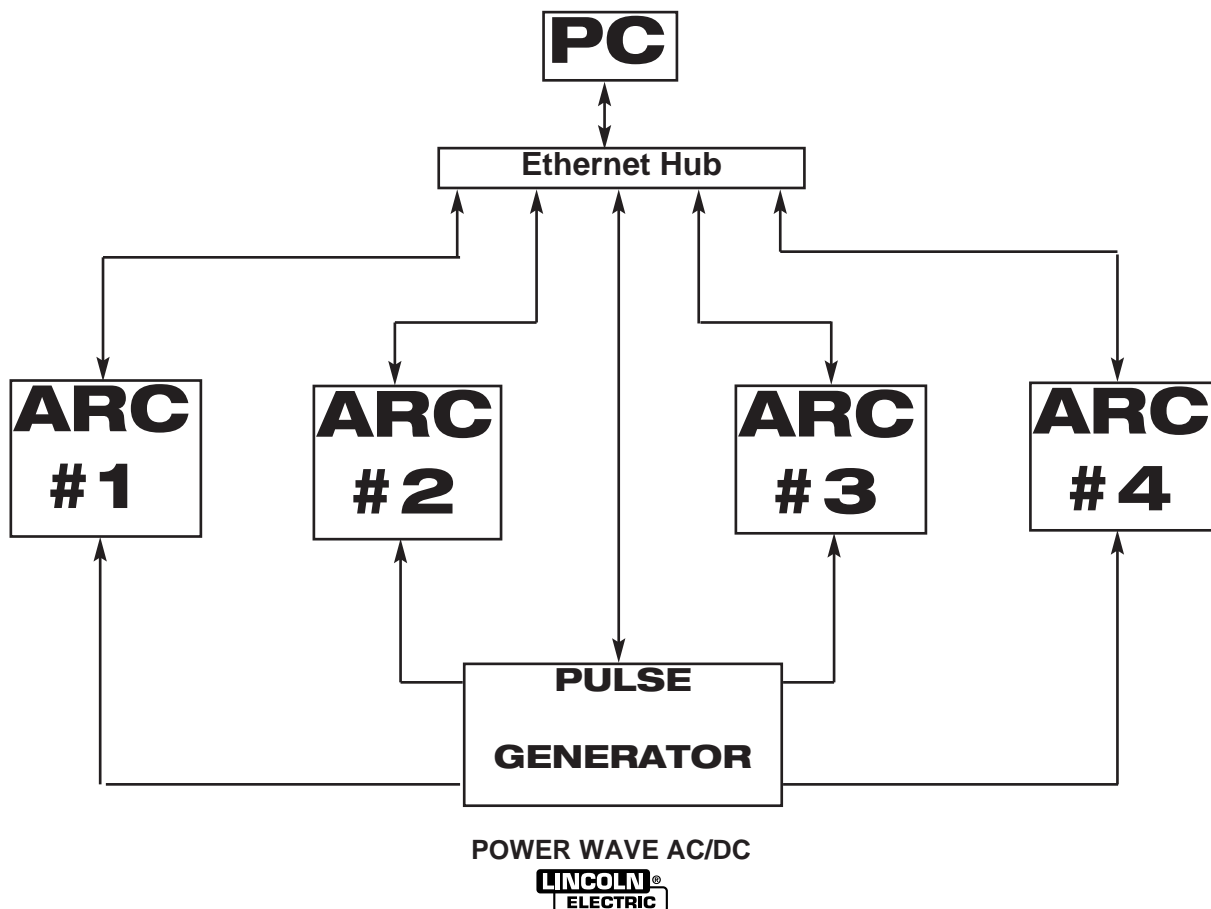

## SAFETY PRECUATIONS

Read this entire section of operating instructions before operating the machine.



### WARNING



#### ELECTRIC SHOCK can kill.

- Unless using cold feed feature, when feeding with gun trigger, the electrode and drive mechanism are always electrically energized and could remain energized several seconds after the welding ceases.
- Do not touch electrically live parts or electrodes with your skin or wet clothing.
- Insulate yourself from the work and ground.
- Always wear dry insulating gloves.



#### FUMES AND GASES can be dangerous.

- Keep your head out of fumes.
- Use ventilation or exhaust to remove fumes from breathing zone.

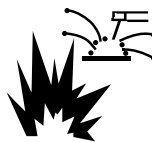

#### WELDING SPARKS can cause fire or explosion.

- Keep flammable material away.
- Do not weld on containers that have held combustibles.





















#### ARC RAYS can burn.

- Wear eye, ear, and body protection.

Observe additional guidelines detailed in the beginning of this manual.

## GRAPHIC SYMBOLS THAT APPEAR ON THIS MACHINE OR IN THIS MANUAL

	INPUT POWER		SMAW
	ON		GMAW
	OFF		FCAW
	HIGH TEMPERATURE		GTAW
	MACHINE STATUS	$U_0$	OPEN CIRCUIT VOLTAGE
	CIRCUIT BREAKER	$U_1$	INPUT VOLTAGE
	WIRE FEEDER	$U_2$	OUTPUT VOLTAGE
	POSITIVE OUTPUT	$I_1$	INPUT CURRENT
	NEGATIVE OUTPUT	$I_2$	OUTPUT CURRENT
	3 PHASE INVERTER		PROTECTIVE GROUND
	INPUT POWER		WARNING
$3 \sim$	THREE PHASE		
	DIRECT CURRENT		

## DEFINITION OF WELDING TERMS

### NON-SYNERGIC WELDING MODES

- A **Non-synergic** welding mode requires all welding process variables to be set by the operator.

### SYNERGIC WELDING MODES

- A **Synergic** welding mode offers the simplicity of single knob control. The machine will select the correct voltage and amperage based on the wire feed speed (WFS) set by the operator.

#### WFS

- Wire Feed Speed

#### CC

- Constant Current

#### CV

- Constant Voltage

#### GMAW (MIG)

- Gas Metal Arc welding

#### GMAW-P (MIG)

- Gas Metal Arc welding-(Pulse)

#### GMAW-PP (MIG)

- Gas Metal Arc welding-(Pulse-on-Pulse)

#### GTAW (TIG)

- Gas Tungsten Arc welding

#### SMAW (STICK)

- Shielded Metal Arc welding

#### FCAW (INNERSHIELD)

- Flux Core Arc Welding

#### SAW

- Submerged Arc welding

## GENERAL DESCRIPTION

The Power Wave AC/DC power source is designed to be a part of a modular welding system. Each welding arc may be driven by a single machine or by a number of machines in parallel. Additionally with the use of an external Phase Generator the phase angle and frequency of different machines can be synchronized.

The Power Wave AC/DC is a high performance, digitally controlled inverter welding power source capable of complex, high-speed waveform control. The Power Wave AC/DC is capable of producing a variable frequency and amplitude AC output, a DC positive output, or a DC negative output. The Power Wave AC/DC can support constant current, constant voltage and pulse welding modes.

The Power Wave AC/DC is designed to communicate with other Arc-Link equipment. Additionally it can communicate with other industrial machines via DeviceNET. Also the Power Wave AC/DC machines are capable of communicating by Ethernet. The result is a highly integrated and flexible welding cell.

## RECOMMENDED PROCESSES AND EQUIPMENT

### RECOMMENDED PROCESSES

The Power Wave AC/DC can be set up in a number of configurations, some requiring optional equipment or welding programs. Each machine is factory preprogrammed with multiple welding procedures, typically including SAW, GMAW, GMAW-P, FCAW, GTAW for a variety of materials, including mild steel, stainless steel, cored wires, and aluminum. It carries an output rating of 500 amps, 44 volts (at 100% duty cycle).

The Power Wave AC/DC can be configured for robotic, hard-automation or semi-automatic use.

### PROCESS LIMITATIONS

The Power Wave AC/DC is suitable only for the processes listed.

## RECOMMENDED EQUIPMENT /INTERFACE

### Robotic Operation

All welding programs and procedures are configured through software for the robotic Power Waves. With the proper configuration, Fanuc robots equipped with RJ-3 or RJ-3iB controllers may communicate directly to the Power Wave via ArcLink or DeviceNet. Proper configuration and options allow other equipment such as PLC's or computers to interface with a Power Wave through a serial, DeviceNet, ArcLink, or Ethernet interfaces. All wire welding processes require a robotic Power Feed wire feeder.

### Hard Automation

Operating the Power Wave AC/DC in a hard automation application requires a PC or PLC for the user interface. The power source communicates with the PC via Ethernet. A wire feeder can be controlled through Arc-link, DeviceNET or Ethernet.

### SemiAutomatic Operation

Operating the Power Wave AC/DC in the semi-automatic mode requires an Arc-Link compatible wire feeder and user interface.

## EQUIPMENT LIMITATIONS

- The Power Waves are not to be used in outdoor environments.
- Only Arc-Link Power Feed wire feeders may be used with standard interfaces. Other Lincoln wire feeders or non-Lincoln wire feeders can only be used with custom interfaces.
- Operating Temperature Range is -20C to + 40C.
- The Power Wave AC/DC will support a maximum average output current of 500 Amps at 100% Duty Cycle.

## REQUIRED EQUIPMENT

- Control Cables (22 pin to 22 pin), K1795-10,-25,-50,-100
- Control Cables (for use on FANUC robot arm, 22 pin to 14 pin, 10 ft), K1804-1
- Control Cables (for use on FANUC robot arm, 22 pin to 14 pin, 18 in), K1805-1
- Control Cables (for use on FANUC robot arm, 22 pin to 14 pin, 18 in), K1804-2

## DUTY CYCLE AND TIME PERIOD

The Power Wave AC/DC is capable of welding at a 100% duty cycle (continuous welding).



**CASE FRONT CONTROLS**

All operator controls and adjustments are located on the case front of the Power Wave. (See Figure B.1)

1. POWER SWITCH: Controls input power to the Power Wave.
2. STATUS LIGHT: A two color light that indicates system errors. Normal operation is a steady green light. Error conditions are indicated per table B1.

**NOTE:** The robotic PowerWaves' status light will flash green, for up to 15 seconds when the machine is first turned on. This is a normal situation as the machine goes through a self test at power up.

TABLE B1

Light Condition	Meaning
Steady Green	System OK. Power source communicating normally with wire feeder and its components.
Blinking Green	Occurs during a reset, and indicates the PW-AC/DC is mapping (identifying) each component in the system. Normal for first 1-10 seconds after power is turned on, or if the system configuration is changed during operation.
Alternating Green and Red	<p>Non-recoverable system fault. If the PS Status light is flashing any combination of red and green, errors are present in the PW-AC/DC. Read the error code before the machine is turned off.</p> <p>Error Code interpretation through the Status light is detailed in the Service Manual. Individual code digits are flashed in red with a long pause between digits. If more than one code is present, the codes will be separated by a green light.</p> <p>To clear the error, turn power source off, and back on to reset. See Troubleshooting Section.</p>
Steady Red	Not applicable.
Blinking Red	Not applicable.

3. HIGH TEMPERATURE LIGHT (thermal overload): A yellow light that comes on when an over temperature situation occurs. Output is disabled until the machine cools down. When cool, the light goes out and output is enabled.
4. 10 AMP WIRE FEEDER CIRCUIT BREAKER: Protects 40 volt DC wire feeder power supply.
5. AUXILIARY POWER CIRCUIT BREAKER: Protects case front receptacle auxiliary supply. (10 amp on non-CE models, 5 amp on CE models.)

6. LEAD CONNECTOR S2 (SENSE LEAD)
7. 5-PIN ARC LINK S1
8. 5-PIN DEVICENET CONNECTOR S5
9. I / O CONNECTOR
10. NEGATIVE STUD
11. INTERFACE CONNECTOR S6
12. POSITIVE STUD
13. AUXILIARY OUTPUT
14. ETHERNET CONTROLS (NOT SHOWN)

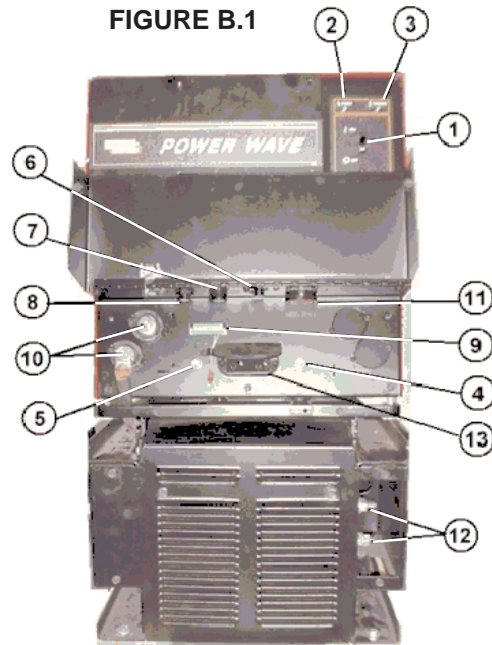

Case Front Layout  
Power Wave AC/DC (Domestic/Canadian Version)

**WELDER OPERATION**

**Making a Weld**

The serviceability of a product or structure utilizing the welding programs is and must be the sole responsibility of the builder/user. Many variables beyond the control of The Lincoln Electric Company affect the results obtained in applying these programs. These variables include, but are not limited to, welding procedure, plate chemistry and temperature, weldment design, fabrication methods and service requirements. The available range of a welding program may not be suitable for all applications, and the build/user is and must be solely responsible for welding program selection.

The steps for operating the Power Wave will vary depending upon the user interface of the welding system. The flexibility of the Power Wave lets the user customize operation for the best performance.

First, consider the desired welding process and the part to be welded. Choose an electrode material, diameter, shielding gas and process (GMAW, GMAW-P, SAW, etc.)

Second, find the program in the welding software that best matches the desired welding process. The standard software shipped with the Power Waves encompasses a wide range of common processes and will meet most needs. If a special welding program is desired, contact the local Lincoln Electric sales representative.

To make a weld, the Power Wave needs to know the desired welding parameters. ArcLink allows full customization for exacting performance. The Power Wave can be programmed with specific values for Strike, Run-in, Crater and other parameters as needed.

The Power Wave supports advanced features, like touch sensing and through-the-arc-seam tracking (TAST).

## WELDING ADJUSTMENTS

All adjustments are made on through the user interface which can vary. Because of the different configuration options your system may not have all of the following adjustments. Regardless of availability, all controls are described below.

## GENERAL WELDING ADJUSTMENTS

### 1. WFS / AMPS:

In synergic welding modes (synergic CV, pulse GMAW) WFS (wire feed speed) is the dominant control parameter, controlling all other variables. The user adjusts WFS according to factors such as weld size, penetration requirements, heat input, etc. The Power Wave then uses the WFS setting to adjust its output characteristics (output voltage, output current) according to pre-programmed settings contained in the Power Wave. In non-synergic modes, the WFS control behaves more like a conventional CV power source where WFS and voltage are independent adjustments. Therefore to maintain the arc characteristics, the operator must adjust the voltage to compensate for any changes made to the WFS.

### 2. VOLTS / TRIM:

In constant voltage modes (synergic CV, standard CV) the control adjusts the welding voltage.

In pulse synergic welding modes (pulse GMAW only) the user can change the Trim setting to adjust the arc length. It is adjustable from 0.500 to 1.500. A Trim setting of 1.000 is a good starting point for most conditions.

### 3. WELDING MODE:

May be selected by name (CV/MIG, CC/Stick Crisp, Gouge, etc.) or by a mode number (10, 24, 71, etc.). Selecting a welding mode determines the output characteristics of the Power Wave power source

### 4. ARC CONTROL:

Also known as Inductance or Wave Control. Allows operator to vary the arc characteristics from "soft" to "harsh" in all weld modes. It is adjustable from -10.0 to +10.0, with a nominal setting of 0.0.

## CV WELDING

### Synergic CV:

For each wire feed speed, a corresponding voltage is preprogrammed into the machine through special software at the factory. The nominal preprogrammed voltage is the best average voltage for a given wire feed speed, but may be adjusted to preference. With synergic programs, when the wire feed speed changes the Power Wave will automatically adjust the voltage correspondingly to maintain similar arc characteristics throughout the WFS range.

### Non Synergic CV:

This type of CV mode behaves more like a conventional CV power source. Voltage and WFS are independent adjustments. Therefore to maintain the arc characteristics, the operator must adjust the voltage to compensate for any changes made to the WFS.

### All CV Modes:

Wave control adjusts the inductance of the wave shape. (This adjustment is often referred to as "pinch".) Inductance is inversely proportional pinch.) Increasing wave control greater than 0.0 results in a crispier, colder arc while decreasing the wave control to less than 0.0 provides a softer, hotter arc.

(See Figure B.2 for **CURRENT WAVE FORM (CV)**)

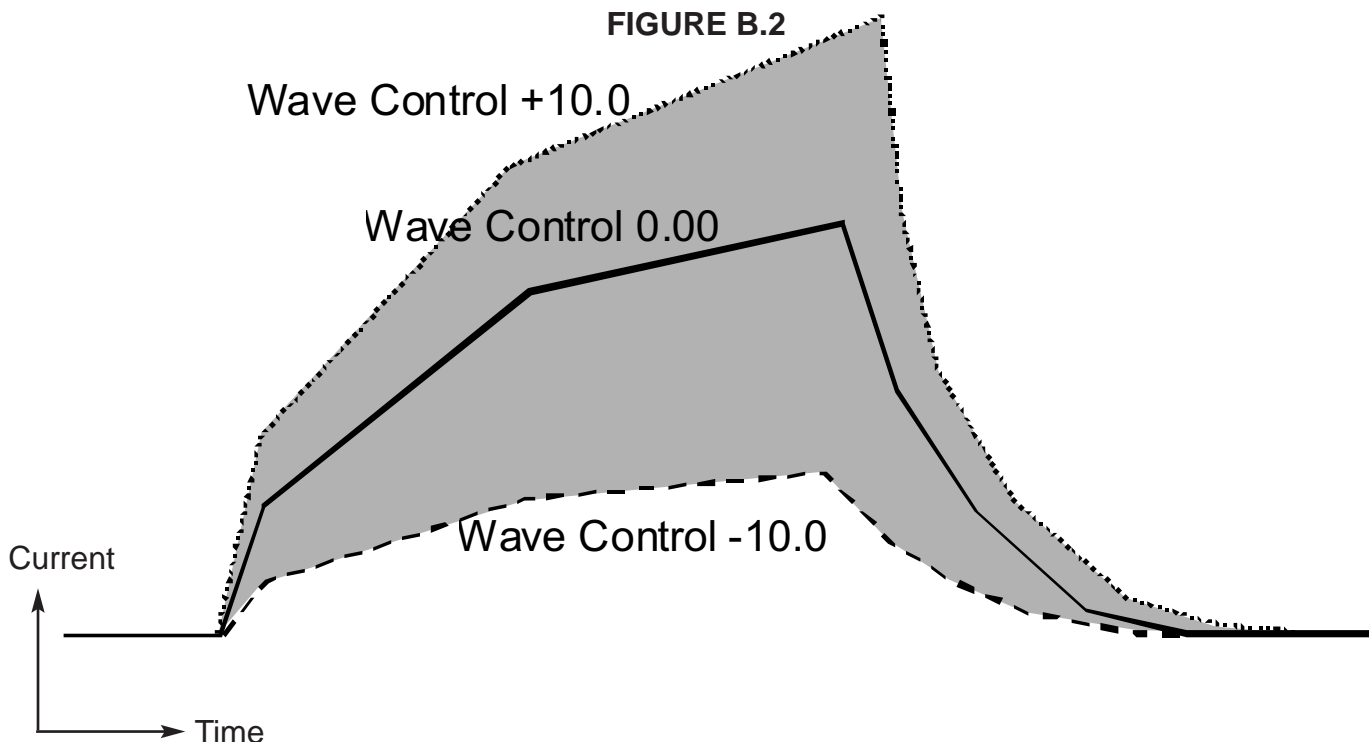

## PULSE WELDING

Pulse welding procedures are set by controlling an overall "arc length" variable. When pulse welding, the arc voltage is highly dependent upon the waveform. The peak current, back ground current, rise time, fall time and pulse frequency all affect the voltage. The exact voltage for a given wire feed speed can only be predicted when all the pulsing waveform parameters are known. Using a preset voltage becomes impractical, and instead the arc length is set by adjusting "trim".

Trim adjusts the arc length and ranges from 0.50 to 1.50, with a nominal value of 1.00. Trim values greater than 1.00 increase the arc length, while values less than 1.00 decrease the arc length.

Most pulse welding programs are synergetic. As the wire feed speed is adjusted, the Power Wave will automatically recalculate the waveform parameters to maintain similar arc properties.

The Power Wave utilizes "adaptive control" to compensate for changes in electrical stick-out while welding. (Electrical stick-out is the distance from the contact tip to the work piece.) **The Power Wave waveforms are optimized for a 0.75" (19mm) stick-out.** The adaptive behavior supports a range of stickouts from 0.50" (13mm) to 1.25" (32mm). At very low or high wire feed speeds, the adaptive range may be less due to reaching physical limitations of the welding process.

Wave control in pulse programs usually adjusts the focus or shape of the arc. Wave control values greater than 0 increase the pulse frequency while decreasing the background current, resulting in a tight, stiff arc best for high speed sheet metal welding. Wave control values less than 0 decrease the pulse frequency while increasing the background current, for a soft arc good for out-of-position welding. (See Figure B.3)

FIGURE B.3

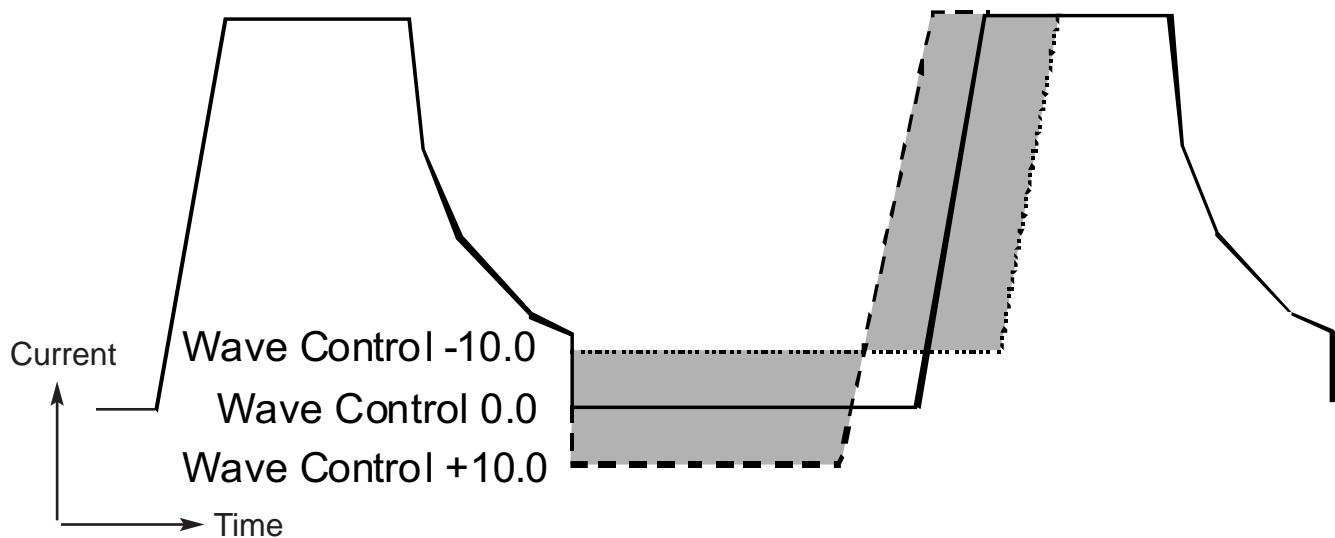

---

**OPTIONAL EQUIPMENT****FACTORY INSTALLED**

There are no factory installed options available for the Power Wave.

**FIELD INSTALLED OPTIONS / ACCESSORIES****Required Accessories****For Paralleling machines**

- Control Cables (22 pin to 22 pin), K1795-10,-25,-50,-100

**In Robotic Applications**

- Control Cables (for use on FANUC robot arm, 22 pin to 14 pin, 10 ft), K1804-1
- Control Cables (for use on FANUC robot arm, 14 pin to 22 pin, 18 in), K1805-1
- Control Cables (for use on FANUC robot arm, 22 pin to 14 pin, 18 in), K1804-2

**Optional Accessories**

- Work Voltage Sense Lead Kit K940
- Gas Guard Regulator, K659-1
- Coaxial welding Cable, K1796

**Compatible Lincoln equipment**

- PF-10/R Wire Feeder, K1780-1
- Any arc-link compatible wire feeding equipment

## SAFETY PRECAUTIONS



### WARNING

#### ELECTRIC SHOCK can kill.



- Only Qualified personnel should perform this maintenance.
- Turn the input power OFF at the disconnect switch or fuse box before working on this equipment.
- Do not touch electrically hot parts.

## ROUTINE MAINTENANCE

Routine maintenance consists of periodically blowing out the machine, using a low pressure airstream, to remove accumulated dust and dirt from the intake and outlet louvers, and the cooling channels in the machine.

## PERIODIC MAINTENANCE

Calibration of the Power Wave AC/DC is critical to its operation. Generally speaking the calibration will not need adjustment. However, neglected or improperly calibrated machines may not yield satisfactory weld performance. To ensure optimal performance, the calibration of output Voltage and Current should be checked yearly.

## CALIBRATION SPECIFICATION

Output Voltage and Current are calibrated at the factory. Generally speaking the machine calibration will not need adjustment. However, if the weld performance changes, or the yearly calibration check reveals a problem, contact the Lincoln Electric Company for the calibration software utility.

The calibration procedure itself requires the use of a grid, and certified actual meters for voltage and current. The accuracy of the calibration will be directly affected by the accuracy of the measuring equipment you use. Detailed instructions are available with the utility.

---

**HOW TO USE TROUBLESHOOTING GUIDE****⚠ WARNING**

Service and Repair should only be performed by Lincoln Electric Factory Trained Personnel. Unauthorized repairs performed on this equipment may result in danger to the technician and machine operator and will invalidate your factory warranty. For your safety and to avoid Electrical Shock, please observe all safety notes and precautions detailed throughout this manual.

This Troubleshooting Guide is provided to help you locate and repair possible machine malfunctions. Simply follow the three-step procedure listed below.

**Step 1. LOCATE PROBLEM (SYMPTOM).**

Look under the column labeled “PROBLEM (SYMPTOMS)”. This column describes possible symptoms that the machine may exhibit. Find the listing that best describes the symptom that the machine is exhibiting.

**Step 2. POSSIBLE CAUSE.**

The second column labeled “POSSIBLE CAUSE” lists the obvious external possibilities that may contribute to the machine symptom.

**Step 3. RECOMMENDED COURSE OF ACTION**

This column provides a course of action for the Possible Cause, generally it states to contact your local Lincoln Authorized Field Service Facility.

If you do not understand or are unable to perform the Recommended Course of Action safely, contact your local Lincoln Authorized Field Service Facility.

**⚠ CAUTION**

If for any reason you do not understand the test procedures or are unable to perform the tests/repairs safely, contact your **Local Lincoln Authorized Field Service Facility** for technical troubleshooting assistance before you proceed.

---

Observe all Safety Guidelines detailed throughout this manual

PROBLEMS (SYMPTOMS)	POSSIBLE AREAS OF MISADJUSTMENT(S)	RECOMMENDED COURSE OF ACTION
<b>OUTPUT PROBLEMS</b>		
Major physical or electrical damage is evident when the sheet metal covers are removed.	1. Contact your local authorized Lincoln Electric Field Service facility for technical assistance.	If all recommended possible areas of misadjustments have been checked and the problem persists, <b>contact your local Lincoln Authorized Field Service Facility.</b>
Input fuses keep blowing, or input breaker keeps tripping.	<ol style="list-style-type: none"> <li>1. Make certain that fuses or breakers are properly sized. See Installation section of this manual for recommended fuse and breaker sizes.</li> <li>2. Welding procedure is drawing too much output current, or duty cycle is too high. Reduce output current, duty cycle, or both.</li> <li>3. There is internal damage to the power source. Contact an authorized Lincoln Electric Service facility.</li> </ol>	
Machine will not power up (no lights, no fan, etc.)	<ol style="list-style-type: none"> <li>1. Make certain that the Power Switch (SW1) is in the "ON" position.</li> <li>2. Circuit breaker CB4 (in reconnect area) may have opened. Reset. Also, check input voltage selection, below.</li> <li>3. Input voltage selection made improperly. Power down, check input voltage reconnect according to diagram on reconnect cover.</li> </ol>	



## CAUTION

If for any reason you do not understand the test procedures or are unable to perform the tests/repairs safely, contact your local authorized Lincoln Electric Field Service Facility for technical assistance.

POWER WAVE AC/DC





Observe all Safety Guidelines detailed throughout this manual

PROBLEMS (SYMPTOMS)	POSSIBLE AREAS OF MISADJUSTMENT(S)	RECOMMENDED COURSE OF ACTION
<b>OUTPUT PROBLEMS</b>		
Thermal LED is lit.	<ol style="list-style-type: none"> <li>1. Machine's thermostat has opened. Check for proper fan operation. There are two main fans in the PowerWave AC/DC. One machine is located in the lower portion of the machine which should be running whenever the machine is on. The other fan is located in the upper portion of the machine and only runs when the machine is triggered. Check for material blocking intake or exhaust louvers, or for excessive dirt clogging cooling channels in machine.</li> <li>2. DC Bus PC board thermostat has opened check for excessive load on 40VDC supply.</li> <li>3. Be sure process does not exceed duty cycle limit of the machine.</li> </ol>	
Machine won't weld, can't get any output. (CR1 will not pull in.)	<ol style="list-style-type: none"> <li>1. Input voltage is too low or too high. Make certain that input voltage is proper, according to the Rating Plate located on the rear of the machine.</li> <li>2. If the Thermal LED is also lit, see "Yellow Thermal LED is Lit" section.</li> <li>3. Primary current limit has been exceeded. Possible short in output circuit. Turn machine off. Remove all loads from the output of the machine. Turn back on. If condition persists, turn power off, and contact an authorized Lincoln Electric Field Service facility.</li> <li>4. This problem will normally be accompanied by an error code. Error codes are displayed as a series of red and green flashes by the status light. See "Troubleshooting the Power Wave / Power Feed System Using the Status LED" section of this text.</li> </ol>	<p>If all recommended possible areas of misadjustments have been checked and the problem persists, <b>contact your local Lincoln Authorized Field Service Facility.</b></p>



## CAUTION

If for any reason you do not understand the test procedures or are unable to perform the tests/repairs safely, contact your local authorized Lincoln Electric Field Service Facility for technical assistance.

POWER WAVE AC/DC



Observe all Safety Guidelines detailed throughout this manual

PROBLEMS (SYMPTOMS)	POSSIBLE AREAS OF MISADJUSTMENT(S)	RECOMMENDED COURSE OF ACTION
<b>OUTPUT PROBLEMS</b>		
Machine often “noodle welds” (output is limited to approximately 100 amps) when running a particular procedure	1. Secondary current limit has been exceeded, and the machine has phased back to protect itself. Adjust procedure or reduce load to lower current draw from the machine.	If all recommended possible areas of misadjustments have been checked and the problem persists, <b>contact your local Lincoln Authorized Field Service Facility.</b>
Auxiliary receptacle is “dead” — no auxiliary voltage .	1. Circuit breaker CB2 (on case front) may have opened. Reset. 2. Circuit breaker CB4 (in reconnect area) may have opened. Reset.	
The Power Wave is triggered to weld, but there is no output.	1. Check for fault signals from the I/O connector. Possible faults are lack of water flow 2. Circuit breaker CB4 (in reconnect area) may have opened. Reset.	



### CAUTION

If for any reason you do not understand the test procedures or are unable to perform the tests/repairs safely, contact your local authorized Lincoln Electric Field Service Facility for technical assistance.

POWER WAVE AC/DC



Observe all Safety Guidelines detailed throughout this manual

PROBLEMS (SYMPTOMS)	POSSIBLE AREAS OF MISADJUSTMENTS(S)	RECOMMENDED COURSE OF ACTION
<b>OUTPUT PROBLEMS</b>		
General degradation of the weld performance.	<ol style="list-style-type: none"> <li>1. Check for feeding problems, bad connections, excessive loops in cabling, etc..</li> <li>2. Verify weld mode is correct for processes.</li> <li>3. The power source may require calibration.               <ul style="list-style-type: none"> <li>• Check the current calibration</li> <li>• Check the voltage calibration</li> <li>• Check the WFS calibration</li> </ul> </li> </ol>	<p>If all recommended possible areas of misadjustments have been checked and the problem persists, <b>contact your local Lincoln Authorized Field Service Facility.</b></p>
The Power Wave is triggered to weld, but there is no output.	<ol style="list-style-type: none"> <li>1. Check for fault signals from the I/O connector. Possible faults are lack of water flow / water flow turned off.</li> </ol>	
The feeder will not cold inch wire	<ol style="list-style-type: none"> <li>1. Check for fault signals from the I/O connector. Possible faults are lack of water flow / water cooler turned off.</li> </ol>	
Excessively long and erratic arc.	<ol style="list-style-type: none"> <li>1. Check for proper configuration and implementation of voltage sensing circuits.</li> </ol>	
Arc loss fault on robot	<ol style="list-style-type: none"> <li>1. Possibly caused by wire feeding problem.</li> <li>2. Possible causes/solutions are:               <ul style="list-style-type: none"> <li>• Problem - Conduit leading to the wire feeder has bends or twists, which can reduce the wire feed speed.</li> <li>• Solution - Remove bends and twists from conduit.</li> <li>• Problem – Conduit leading up to the wire feeder from the wire reel is too long.</li> <li>• Solution – Use a shorter length of conduit</li> </ul> </li> </ol>	

**⚠ CAUTION**

If for any reason you do not understand the test procedures or are unable to perform the tests/repairs safely, contact your **Local Lincoln Authorized Field Service Facility** for technical troubleshooting assistance before you proceed.

**POWER WAVE AC/DC**



## USING THE STATUS LED TO TROUBLESHOOT SYSTEM PROBLEMS

The Power Wave is equipped with a status light if a problem occurs it is important to note the condition of the status light. Therefore, prior to cycling power to the system, check the power source status light for error sequences as noted below.

Included in this section is information about the power source Status LED, and some basic troubleshooting charts for both machine and weld performance.

Troubleshooting the Power Wave Using the Status LED

The STATUS LIGHT is a two color light that indicates system errors. Normal operation is a steady green light. Error conditions are indicated in the following chart.

Steady Green	System OK. Power source communicating normally with wire feeder and its components.
Blinking Green	Occurs during a reset, and indicates the Power Wave is mapping (identifying) each component in the system. Normal for first 1-10 seconds after power is turned on, or if the system configuration is changed during operation
Alternating Green and Red	<p>Non-recoverable system fault. If the PS Status light is flashing any combination of red and green, errors are present in the Power Wave. <b>Read the error code before the machine is turned off.</b></p> <p>Error Code interpretation through the Status light is detailed in the Service Manual. Individual code digits are flashed in red with a long pause between digits. If more than one code is present, the codes will be separated by a green light.</p> <p>To clear the error, turn power source off, and back on to reset.</p>
Steady Red	Not applicable.
Blinking Red	Not applicable.

Observe all Safety Guidelines detailed throughout this manual

### ERROR CODES FOR THE POWERWAVE

The following is a list of possible error codes that the Power Wave AC/DC can output via the status light (see "Troubleshooting the Power Wave / Power Feed System Using the Status LED").

Error Code #	Indication
31 Primary overcurrent error.	Excessive Primary current present. May be related to a switch board or output rectifier failure.
32 Capacitor "A" under voltage (Left side facing machine)	Low voltage on the main capacitors. May be caused by improper input configuration, or an open/short circuit in the primary side of the machine.
33 Capacitor "B" under voltage (Right side facing machine)	
34 Capacitor "A" over voltage (Left side facing machine)	Excess voltage on the main capacitors. May be caused by improper input configuration, , excessive line voltage, or improper capacitor balance (see Error 43)
35 Capacitor "B" over voltage (Right side facing machine)	
36 Thermal error	Indicates over temperature. Usually accompanied by Thermal LED. Check fan operation. Be sure process does not exceed duty cycle limit of the machine.
37 Softstart error	Capacitor precharge failed. Usually accompanied by codes 32-35.
41 Secondary overcurrent error	The secondary (weld) current limit has been exceeded. When this occurs the machine output will phase back to 100 amps, typically resulting in a condition referred to as "noodle welding" NOTE: For the PowerWave AC/DC the secondary limit is 500
43 Capacitor delta error	The maximum voltage difference between the main capacitors has been exceeded. May be accompanied by errors 32-35. May be caused by an open or short in the primary or secondary circuit(s).
49 Single phase error	Indicates machine is running on single phase input power. Usually caused by the loss of the middle leg (L2).
Other	Error codes that contain three or four digits are defined as fatal errors. These codes generally indicate internal errors on the Power Source Control Board. If cycling the input power on the machine does not clear the error, contact the Service Department.

### CAUTION

If for any reason you do not understand the test procedures or are unable to perform the tests/repairs safely, contact your **Local Lincoln Authorized Field Service Facility** for technical troubleshooting assistance before you proceed.

POWER WAVE AC/DC



POWER WAVE™ AC/DC (460/500/575) POWER SOURCE WIRING DIAGRAM

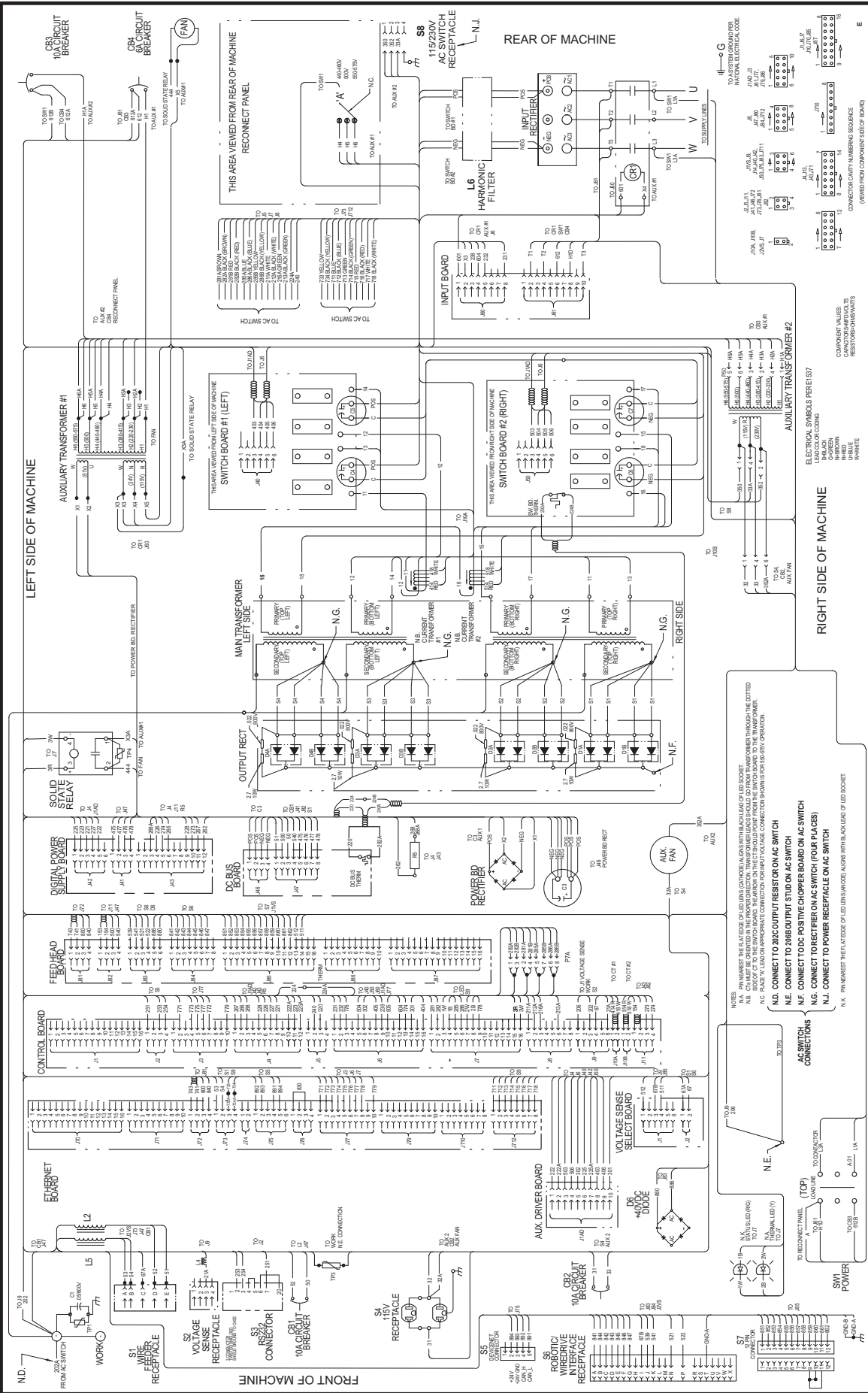

G4048

NOTE: This diagram is for reference only. It may not be accurate for all machines covered by this manual. The specific diagram for a particular code is pasted inside the machine on one of the enclosure panels. If the diagram is illegible, write to the Service Department for a replacement. Give the equipment code number.

POWER WAVE AC/DC



# POWER WAVE™ AC / DC - AC SWITCH

LEFT SIDE OF MACHINE

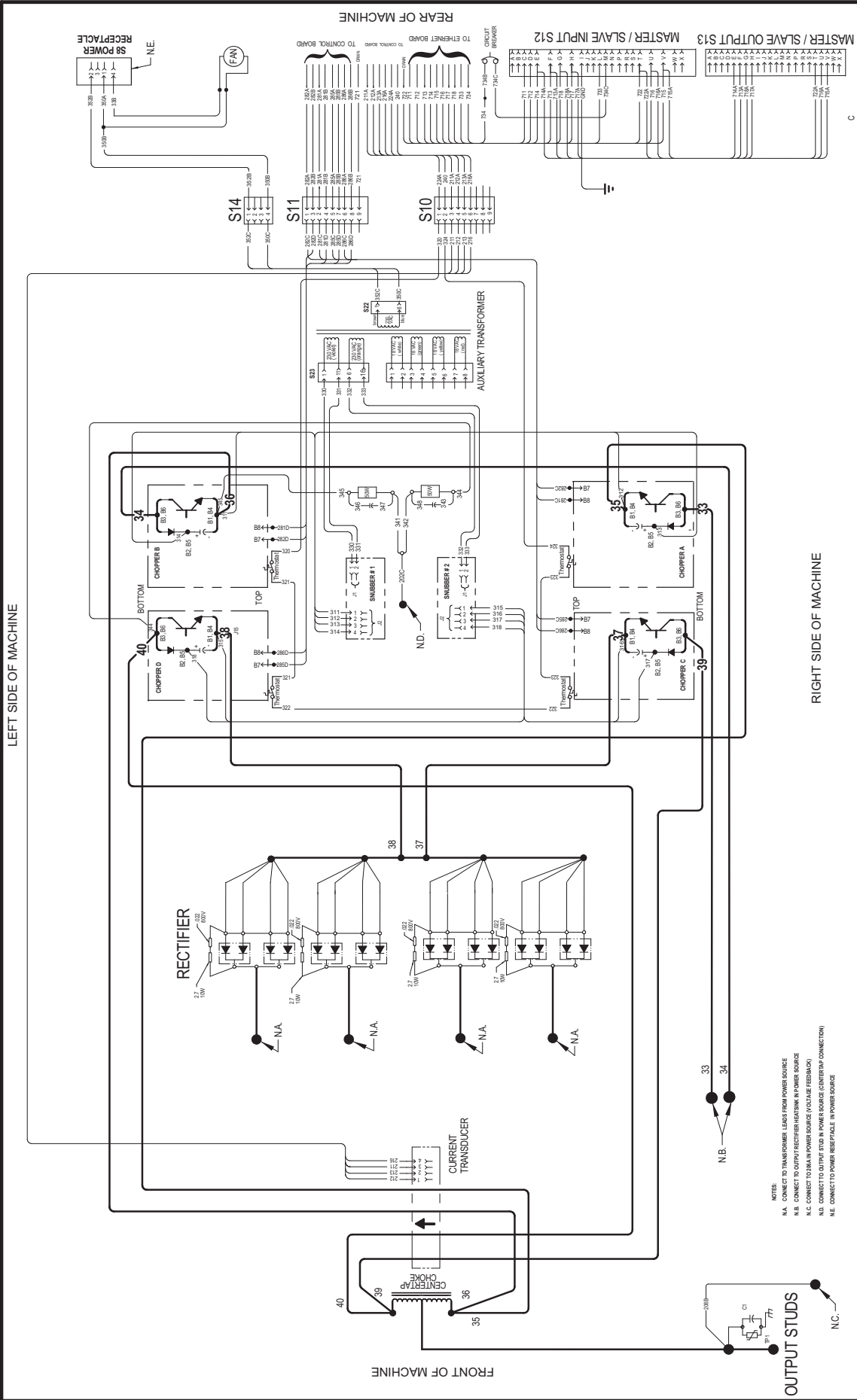

G4076-2

NOTE: This diagram is for reference only. It may not be accurate for all machines covered by this manual. The specific diagram for a particular code is pasted inside the machine on one of the enclosure panels. If the diagram is illegible, write to the Service Department for a replacement. Give the equipment code number..

## POWER WAVE AC/DC



- NOTES:
- N.A. CONNECT TO TRANSFORMER LEADS FROM POWER SOURCE
  - N.B. CONNECT TO OUTPUT RECTIFIER HEATING IN POWER SOURCE
  - N.C. CONNECT TO MAIN POWER SOURCE (VOLTAGE FEEDBACK)
  - N.D. CONNECT TO OUTPUT STUD IN POWER SOURCE (CURRENT CONNECTION)
  - N.E. CONNECT TO POWER RECEPTACLE IN POWER SOURCE

Table F.1 INTERFACE CONNECTOR WIRING

Pin	Robotic Interface Connector (S6)	Master / Slave Input(S12)	Master / Slave Output(S13)
A	+15vdc Tach voltage	Reserved for future use	Reserved for future use
B	Tach common	Reserved for future use	Reserved for future use
C	Tach 1A differential signal	Sync In	Reserved for future use
D	Tach 1B differential signal	Sync In	Reserved for future use
E	Tach 2A differential signal	Ready In	Ready In
F	Tach 2B differential signal	Ready In	Ready In
G	Single Tach Input	Polarity Out	Polarity Out
H	Reserved for future use	Polarity Out	Polarity Out
I	Voltage sense lead	Ground	
J	Motor "+"	Reserved for future use	Reserved for future use
K	Motor "-"	Reserved for future use	Reserved for future use
L	Reserved for future use	+40v (COM)	Reserved for future use
M	Reserved for future use	+40v ("+")	Reserved for future use
N	+40vdc for solenoid	Reserved for future use	Reserved for future use
P	solenoid input	Reserved for future use	Reserved for future use
R	Reserved for future use	Reserved for future use	Reserved for future use
S	Reserved for future use	Reserved for future use	Reserved for future use
T	Shield ground to case	Drain (ethernet)	Drain (ethernet)
U	Reserved for future use	Kill Out	Kill Out
V	Reserved for future use	Kill Out	Kill Out
W	Reserved for future use	Reserved for future use	Reserved for future use
X	Reserved for future use	Reserved for future use	Reserved for future use

TABLE F.2 WIRE FEEDER RECEPTACLE S1

Pin	Lead #	Function
A	53	Arclink L
B	54	Arclink H
C	67A	Electrode Voltage Sense
D	52	Ground(0v)
E	51	+40vdc

TABLE F.5 DEVICENET CONNECTOR S5

Pin	Lead #	Function
2	894	+24vdc Devicenet
3	893	Common Devicenet+
4	892	Devicenet H
5	891	Devicenet L

TABLE F.3 VOLTAGE SENSE RECEPTACLE S2

Pin	Lead #	Function
3	21A	Work Voltage Sense

TABLE F.4 RS232 CONNECTOR S3

Pin	Lead #	Function
2	253	RS232 Receive
3	254	RS232 Transmit
4	#	S3 Pin5
5	#	S3 Pin4
6	##	S3 Pin20
20	##	S3 Pin6
7	251	RS232 Common

TABLE F.6 EXTERNAL I/O S7

Pin	Lead #	Function
1	851	+15vdc for Trigger group
2	852	Trigger input
3	853	Dual procedure input
4	854	4 Step input
5	855	+15vdc for cold inch group
6	856	cold inch forward
7	857	cold inch reverse
8	858	gas purge input
9	859	+15vdc for shutdown group
10	860	shutdown1 input
11	861	shutdown2 input
12	862	input B



## Robotic Set Up, Electrode Positive, CV/Pulse Configuration

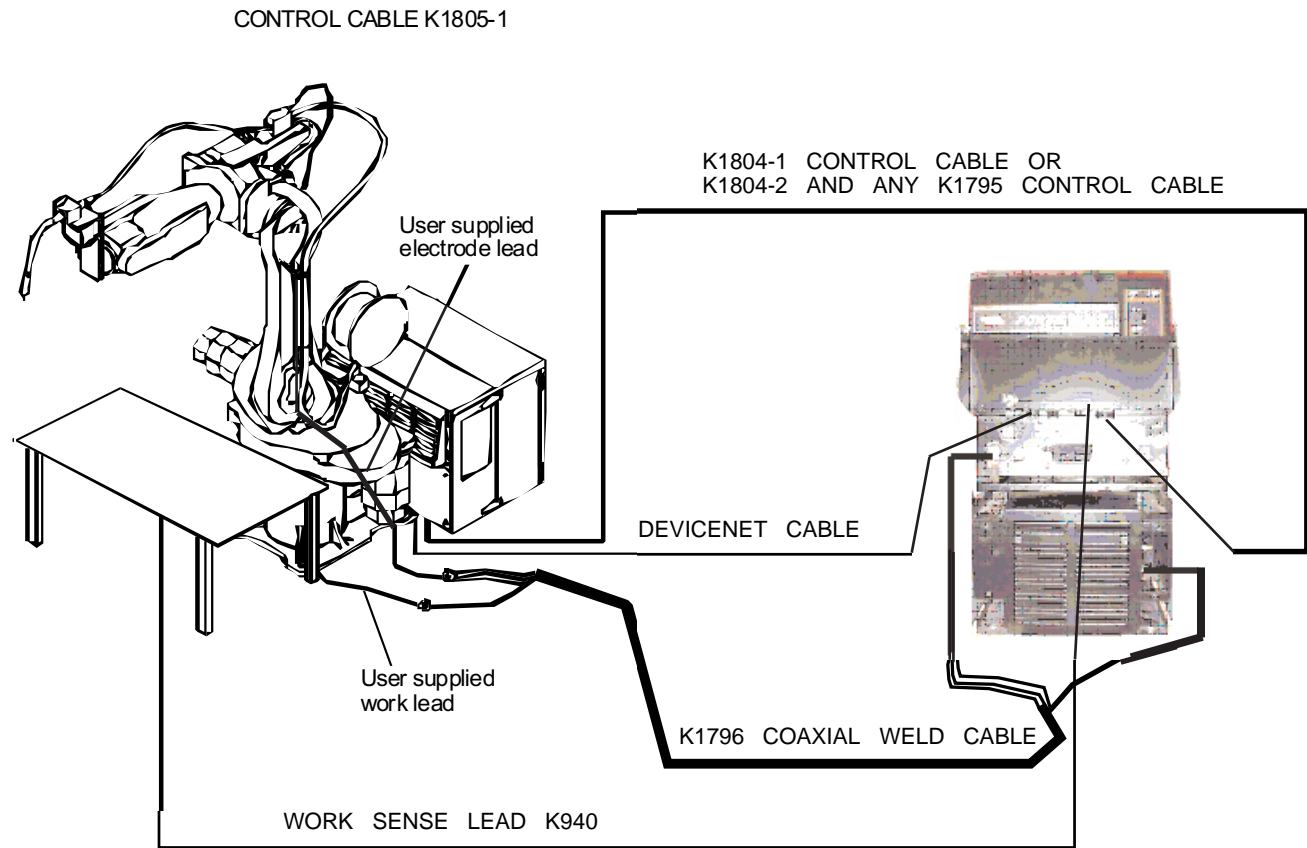

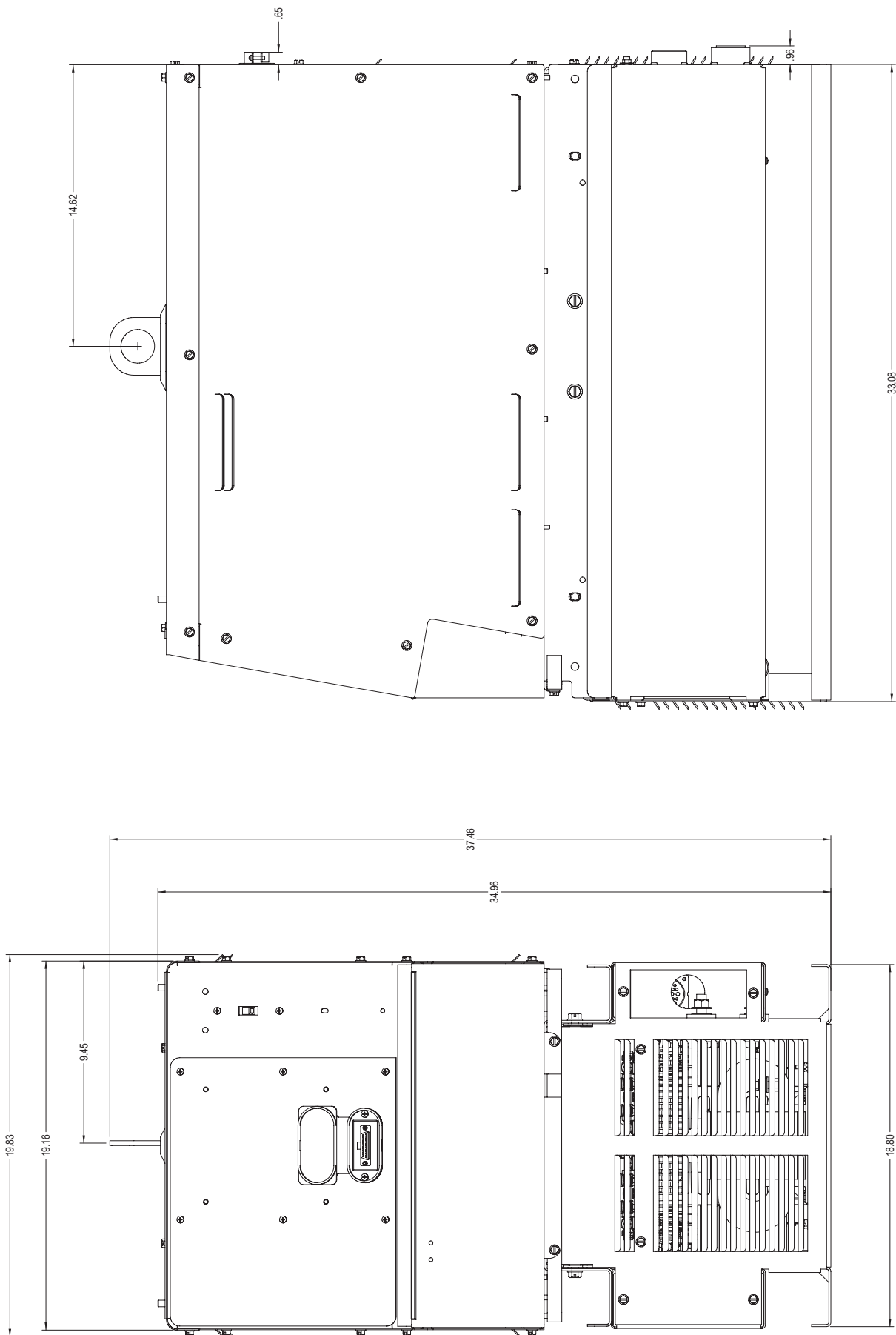

X/A  
L11656

POWER WAVE AC/DC



# NOTES

---

POWER WAVE AC/DC



# NOTES

---

POWER WAVE AC/DC





<b>WARNING</b>	<ul style="list-style-type: none"> <li>Do not touch electrically live parts or electrode with skin or wet clothing.</li> <li>Insulate yourself from work and ground.</li> </ul>	<ul style="list-style-type: none"> <li>Keep flammable materials away.</li> </ul>	<ul style="list-style-type: none"> <li>Wear eye, ear and body protection.</li> </ul>
Spanish <b>AVISO DE PRECAUCION</b>	<ul style="list-style-type: none"> <li>No toque las partes o los electrodos bajo carga con la piel o ropa mojada.</li> <li>Aíslese del trabajo y de la tierra.</li> </ul>	<ul style="list-style-type: none"> <li>Mantenga el material combustible fuera del área de trabajo.</li> </ul>	<ul style="list-style-type: none"> <li>Protéjase los ojos, los oídos y el cuerpo.</li> </ul>
French <b>ATTENTION</b>	<ul style="list-style-type: none"> <li>Ne laissez ni la peau ni des vêtements mouillés entrer en contact avec des pièces sous tension.</li> <li>Isolez-vous du travail et de la terre.</li> </ul>	<ul style="list-style-type: none"> <li>Gardez à l'écart de tout matériel inflammable.</li> </ul>	<ul style="list-style-type: none"> <li>Protégez vos yeux, vos oreilles et votre corps.</li> </ul>
German <b>WARNUNG</b>	<ul style="list-style-type: none"> <li>Berühren Sie keine stromführenden Teile oder Elektroden mit Ihrem Körper oder feuchter Kleidung!</li> <li>Isolieren Sie sich von den Elektroden und dem Erdboden!</li> </ul>	<ul style="list-style-type: none"> <li>Entfernen Sie brennbares Material!</li> </ul>	<ul style="list-style-type: none"> <li>Tragen Sie Augen-, Ohren- und Körperschutz!</li> </ul>
Portuguese <b>ATENÇÃO</b>	<ul style="list-style-type: none"> <li>Não toque partes elétricas e electrodos com a pele ou roupa molhada.</li> <li>Isole-se da peça e terra.</li> </ul>	<ul style="list-style-type: none"> <li>Mantenha inflamáveis bem guardados.</li> </ul>	<ul style="list-style-type: none"> <li>Use proteção para a vista, ouvido e corpo.</li> </ul>
Japanese <b>注意事項</b>	<ul style="list-style-type: none"> <li>通電中の電気部品、又は溶材にヒフやぬれた布で触れないこと。</li> <li>施工物やアースから身体が絶縁されている様にして下さい。</li> </ul>	<ul style="list-style-type: none"> <li>燃えやすいものの側での溶接作業は絶対にしてはなりません。</li> </ul>	<ul style="list-style-type: none"> <li>目、耳及び身体に保護具をして下さい。</li> </ul>
Chinese <b>警告</b>	<ul style="list-style-type: none"> <li>皮肤或湿衣物切勿接触带电部件及焊条。</li> <li>使你自已与地面和工作件绝缘。</li> </ul>	<ul style="list-style-type: none"> <li>把一切易燃物品移离工作场所。</li> </ul>	<ul style="list-style-type: none"> <li>佩戴眼、耳及身体劳动保护用具。</li> </ul>
Korean <b>위험</b>	<ul style="list-style-type: none"> <li>전도체나 용접봉을 젖은 헝겊 또는 피부로 절대 접촉치 마십시오.</li> <li>모재와 접지를 접촉치 마십시오.</li> </ul>	<ul style="list-style-type: none"> <li>인화성 물질을 접근시키지 마십시오.</li> </ul>	<ul style="list-style-type: none"> <li>눈, 귀와 몸에 보호장구를 착용하십시오.</li> </ul>
Arabic <b>تحذير</b>	<ul style="list-style-type: none"> <li>لا تلمس الاجزاء التي يسري فيها التيار الكهربائي أو الألكترود بجسد الجسم أو بالملابس المبللة بالماء.</li> <li>ضع عازلا على جسمك خلال العمل.</li> </ul>	<ul style="list-style-type: none"> <li>ضع المواد القابلة للاشتعال في مكان بعيد.</li> </ul>	<ul style="list-style-type: none"> <li>ضع أدوات وملابس واقية على عينيك وأذنيك وجسمك.</li> </ul>

**READ AND UNDERSTAND THE MANUFACTURER'S INSTRUCTION FOR THIS EQUIPMENT AND THE CONSUMABLES TO BE USED AND FOLLOW YOUR EMPLOYER'S SAFETY PRACTICES.**

**SE RECOMIENDA LEER Y ENTENDER LAS INSTRUCCIONES DEL FABRICANTE PARA EL USO DE ESTE EQUIPO Y LOS CONSUMIBLES QUE VA A UTILIZAR, SIGA LAS MEDIDAS DE SEGURIDAD DE SU SUPERVISOR.**

**LISEZ ET COMPRENEZ LES INSTRUCTIONS DU FABRICANT EN CE QUI REGARDE CET EQUIPMENT ET LES PRODUITS A ETRE EMPLOYES ET SUIVEZ LES PROCEDURES DE SECURITE DE VOTRE EMPLOYEUR.**

**LESEN SIE UND BEFOLGEN SIE DIE BETRIEBSANLEITUNG DER ANLAGE UND DEN ELEKTRODENEINSATZ DES HERSTELLERS. DIE UNFALLVERHÜTUNGSVORSCHRIFTEN DES ARBEITGEBERS SIND EBENFALLS ZU BEACHTEN.**

			
<ul style="list-style-type: none"> <li>● Keep your head out of fumes.</li> <li>● Use ventilation or exhaust to remove fumes from breathing zone.</li> </ul>	<ul style="list-style-type: none"> <li>● Turn power off before servicing.</li> </ul>	<ul style="list-style-type: none"> <li>● Do not operate with panel open or guards off.</li> </ul>	<b>WARNING</b>
<ul style="list-style-type: none"> <li>● Los humos fuera de la zona de respiración.</li> <li>● Mantenga la cabeza fuera de los humos. Utilice ventilación o aspiración para gases.</li> </ul>	<ul style="list-style-type: none"> <li>● Desconectar el cable de alimentación de poder de la máquina antes de iniciar cualquier servicio.</li> </ul>	<ul style="list-style-type: none"> <li>● No operar con panel abierto o guardas quitadas.</li> </ul>	Spanish <b>AVISO DE PRECAUCION</b>
<ul style="list-style-type: none"> <li>● Gardez la tête à l'écart des fumées.</li> <li>● Utilisez un ventilateur ou un aspirateur pour ôter les fumées des zones de travail.</li> </ul>	<ul style="list-style-type: none"> <li>● Débranchez le courant avant l'entretien.</li> </ul>	<ul style="list-style-type: none"> <li>● N'opérez pas avec les panneaux ouverts ou avec les dispositifs de protection enlevés.</li> </ul>	French <b>ATTENTION</b>
<ul style="list-style-type: none"> <li>● Vermeiden Sie das Einatmen von Schweißrauch!</li> <li>● Sorgen Sie für gute Be- und Entlüftung des Arbeitsplatzes!</li> </ul>	<ul style="list-style-type: none"> <li>● Strom vor Wartungsarbeiten abschalten! (Netzstrom völlig öffnen; Maschine anhalten!)</li> </ul>	<ul style="list-style-type: none"> <li>● Anlage nie ohne Schutzgehäuse oder Innenschutzverkleidung in Betrieb setzen!</li> </ul>	German <b>WARNUNG</b>
<ul style="list-style-type: none"> <li>● Mantenha seu rosto da fumaça.</li> <li>● Use ventilação e exaustão para remover fumo da zona respiratória.</li> </ul>	<ul style="list-style-type: none"> <li>● Não opere com as tampas removidas.</li> <li>● Desligue a corrente antes de fazer serviço.</li> <li>● Não toque as partes elétricas nuas.</li> </ul>	<ul style="list-style-type: none"> <li>● Mantenha-se afastado das partes moventes.</li> <li>● Não opere com os painéis abertos ou guardas removidas.</li> </ul>	Portuguese <b>ATENÇÃO</b>
<ul style="list-style-type: none"> <li>● ヒュームから頭を離すようにして下さい。</li> <li>● 換気や排煙に十分留意して下さい。</li> </ul>	<ul style="list-style-type: none"> <li>● メンテナンス・サービスに取りかかる際には、まず電源スイッチを必ず切ってください。</li> </ul>	<ul style="list-style-type: none"> <li>● パネルやカバーを取り外したまま機械操作をしないで下さい。</li> </ul>	Japanese <b>注意事項</b>
<ul style="list-style-type: none"> <li>● 頭部遠離煙霧。</li> <li>● 在呼吸區使用通風或排風器除煙。</li> </ul>	<ul style="list-style-type: none"> <li>● 維修前切斷電源。</li> </ul>	<ul style="list-style-type: none"> <li>● 儀表板打開或沒有安全罩時不準作業。</li> </ul>	Chinese <b>警告</b>
<ul style="list-style-type: none"> <li>● 얼굴로부터 용접가스를 멀리하십시오.</li> <li>● 호흡지역으로부터 용접가스를 제거하기 위해 가스제거기나 통풍기를 사용하십시오.</li> </ul>	<ul style="list-style-type: none"> <li>● 보수전에 전원을 차단하십시오.</li> </ul>	<ul style="list-style-type: none"> <li>● 판넬이 열린 상태로 작동치 마십시오.</li> </ul>	Korean <b>위험</b>
<ul style="list-style-type: none"> <li>● ابعد رأسك بعيداً عن الدخان.</li> <li>● استعمل التهوية أو جهاز ضغط الدخان للخارج لكي تبعد الدخان عن المنطقة التي تتنفس فيها.</li> </ul>	<ul style="list-style-type: none"> <li>● أقطع التيار الكهربائي قبل القيام بأية صيانة.</li> </ul>	<ul style="list-style-type: none"> <li>● لا تشغيل هذا الجهاز اذا كانت الاغطية الحديدية الواقية ليست عليه.</li> </ul>	Arabic <b>تحذير</b>

**LEIA E COMPREENDA AS INSTRUÇÕES DO FABRICANTE PARA ESTE EQUIPAMENTO E AS PARTES DE USO, E SIGA AS PRÁTICAS DE SEGURANÇA DO EMPREGADOR.**

使う機械や溶材のメーカーの指示書をよく読み、まず理解して下さい。そして貴社の安全規定に従って下さい。

請詳細閱讀並理解製造廠提供的說明以及應該使用的銀焊材料，並請遵守貴方的有閣勞動保護規定。

이 제품에 동봉된 작업지침서를 숙지하시고 귀사의 작업자 안전수칙을 준수하시기 바랍니다.

اقرأ بتمعن وافهم تعليمات المصنع المنتج لهذه المعدات والمواد قبل استعمالها واتبع تعليمات الوقاية لصاحب العمل.



• World's Leader in Welding and Cutting Products •

• Sales and Service through Subsidiaries and Distributors Worldwide •

Cleveland, Ohio 44117-1199 U.S.A. TEL: 216.481.8100 FAX: 216.486.1751 WEB SITE: [www.lincolnelectric.com](http://www.lincolnelectric.com)