

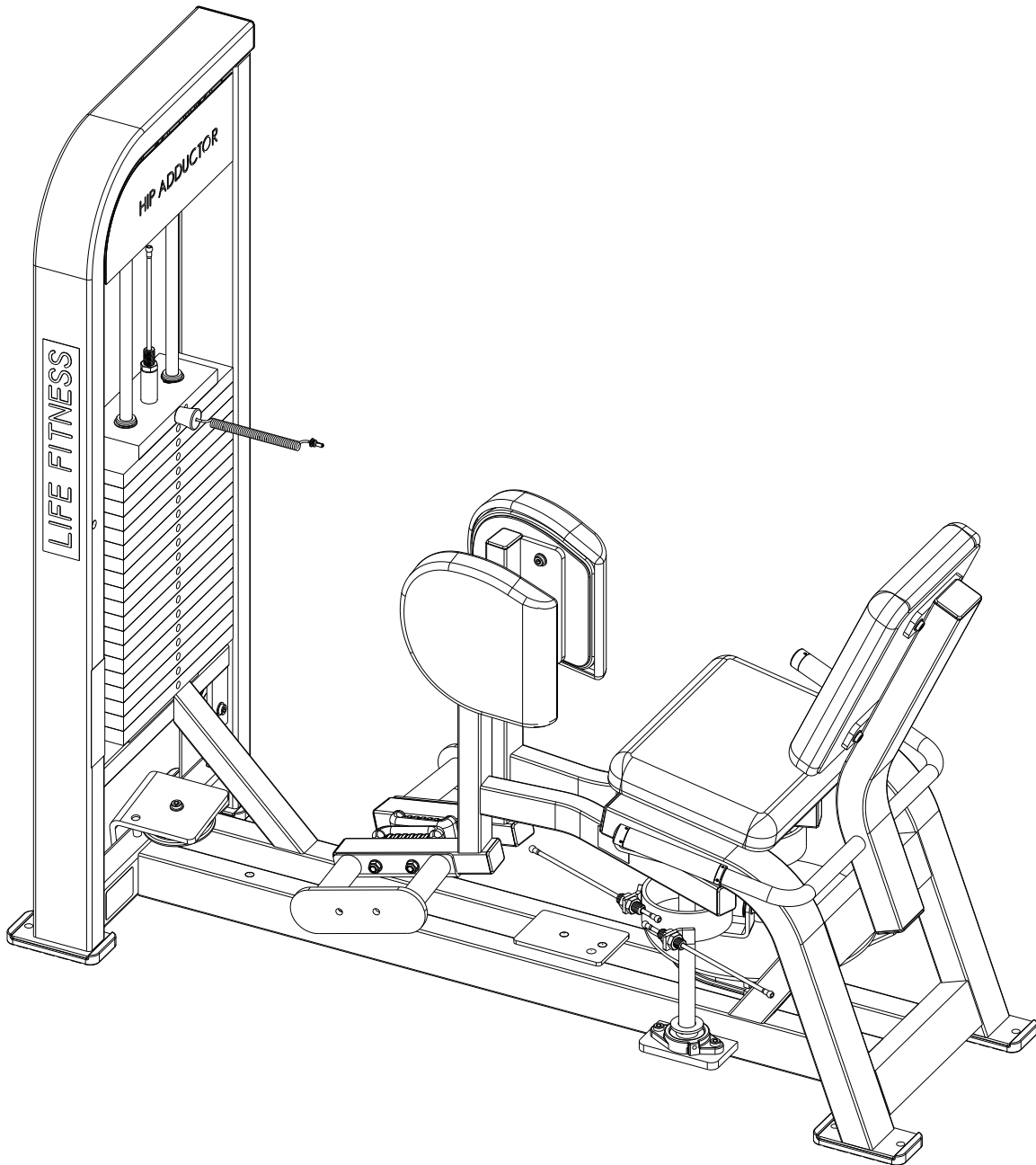

PRO 2 SERIES
PSHADSE HIP ADDUCTION



Customer Support Services
PARTS MANUAL

PSHADSE HIP ADDUCTION CONTENTS

	Page
COMPONENT ASSEMBLY	3
COMPONENT ASSEMBLY LEGEND	4
5LB INCREMENT WEIGHT ASSEMBLY	5
INCREMENT WEIGHT ASSEMBLY W/STRIKER	6
WEIGHT STACK (300LB)	7
REAR SHROUD KIT	8
OPTIONAL FULL SHROUD KIT	9
IMAGE	10

PSHADSE HIP ADDUCTION COMPONENT ASSEMBLY

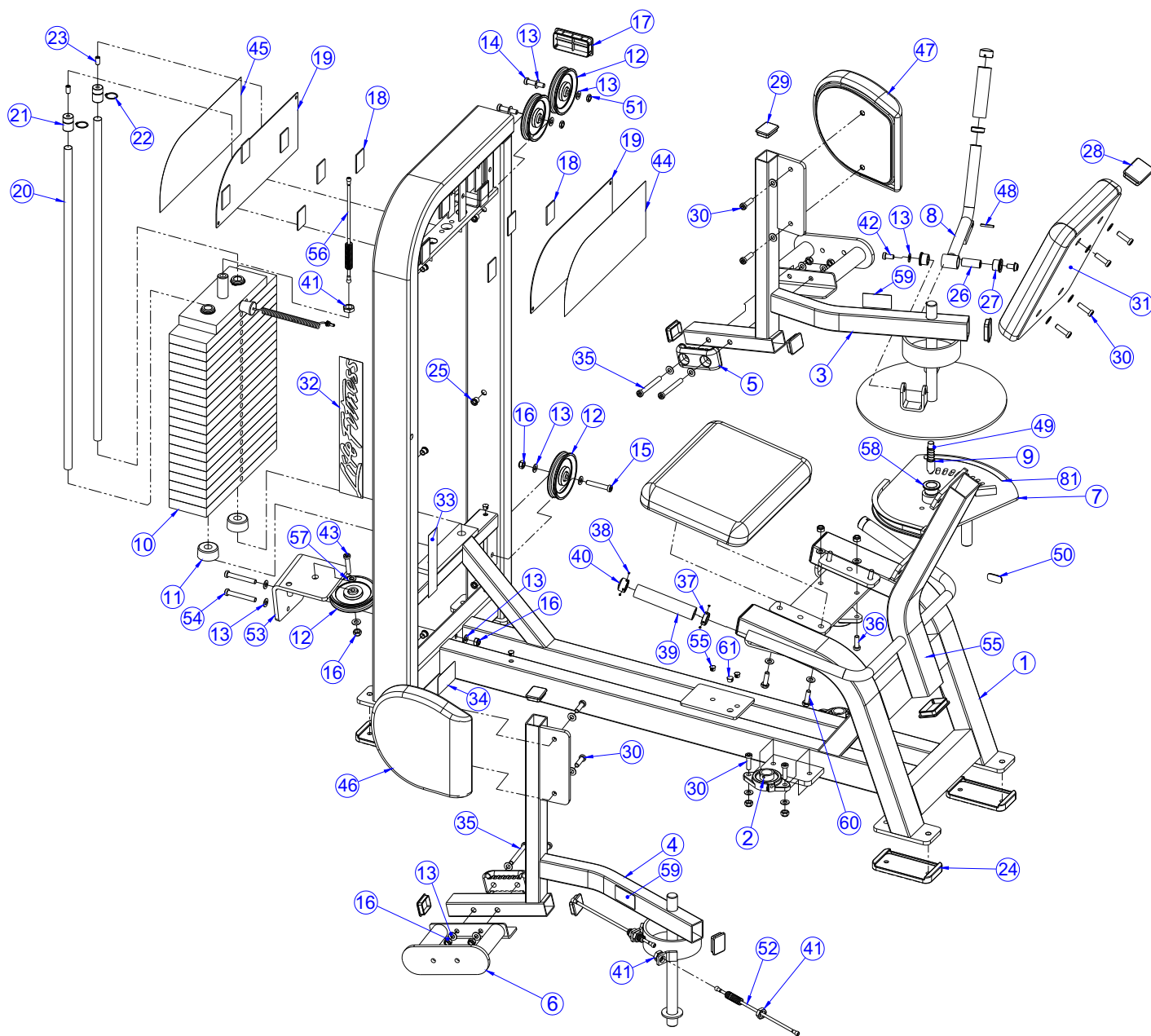

SEE PAGE 4 FOR LEGEND

PSHADSE HIP ADDUCTION COMPONENT ASSEMBLY LEGEND

ITEM NO.	QTY.	PART NO.	DESCRIPTION	ITEM NO.	QTY.	PART NO.	DESCRIPTION
1	1	7546901	WLDMT, PSHAB/HAD MAIN FRAME	32	1	7348001	LABEL, LIFE FITNESS LOGO
2	4	3237701	ASSY, PILLOW BLOCK 4.88 X 2.75	33	1	7422004	LABEL, 2" ASTM WARN
3	1	7551201	WLDMT, PIVOT ARM RIGHT PSHAD	34	1	7571301	LABEL, SERIAL NUMBER
4	1	7551401	WLDMT, PIVOT ARM LEFT PSHAD	35	4	3236214	SCREW, M10 X1.5 85MM
5	2	7352001	BUMPER, 2-1/8 X 4-5/8	36	4	3236203	SCREW, M10 X1.5 30MM
6	2	7551101	WLDMT, FOOT SUPPORT	37	3	7662801	RING, GRIP 1.25 OD
7	1	7551301	WLDMT, CAM PSHAD	38	12	3247701	M4 X .7 HXS NO CUP ST BO
8	1	7551501	WLDMT, ADJUST HANDLE PSHAD/HAB	39	3	3235801	GRIP, TBC
9	1	7549901	PIN, SPRING PSHAD/HAB	40	3	7662901	CAP, GRIP 1.25 OD
10	1	7353501	ASSY, 300LB STACK	41	5	3236902	NUT, M16 X 2 HEX JAM SS
11	2	7352101	CUSHION, WEIGHT STACK	42	2	3236201	SCREW, M10 X1.5 20MM
12	4	3237801	PULLEY, 4.5" OD	43	1	3236207	SCREW, M10 X1.5 50MM
13	41	3236601	WASHER, 3/8 SAE SS	44	1	7549201	LABEL, PSHAD PLACARD
14	2	3236206	SCREW, M10 X1.5 45MM	45	1	7549401	LABEL, PSHAD LOGO PANEL
15	1	3236209	SCREW, M10 X1.5 60MM	46	1	75495xx	PAD, HIP ADDUCTOR LH
16	16	3236801	NUT, M10 HEX NYLOCK SS	47	1	75496xx	PAD, HIP ADDUCTOR RH
17	1	7352401	CAP, END 2 X 4	48	1	3110011	ROLL PIN, 3/16 X 1-1/4
18	12	7544202	PAD, DUAL LOCK 250 1.5" X 2.0"	49	1	7351501	SPRING; PULL PIN LARGE
19	2	7606602	COVER, STACK-PRO2 STD	50	1	7570801	GUARD, PAINT 1.25"x.75"x.25"
20	2	7328614	GUIDE ROD, .75 OD SOLID 35.38	51	2	3236901	NUT, M10 X 1.5 JAM
21	2	7402301	RETAINER, GUIDEROD	52	2	7573701	CABLE, PSHAD/HAB
22	2	3232421	RING, BRE .940, 5100-100 ST PP B	53	1	7573801	WLDMT, PSHAD/HAB PULLEY BRKT
23	2	3240501	M10 X 1.5 HXS NO CUP ST BO	54	2	3236212	SCREW, M10 X1.5 75MM
24	4	7388201	FOOTPAD, PS RUBBER	55	17	3237401	PLUG, 7/16" HOLE
25	6	3238101	NUT, BLIND INSERT M10 X 1.5	56	1	7423712	CABLE, PSHAD/HAB
26	1	7324802	SHAFT, TAPPED 0.75 DIA X 1.800	57	1	7348101	WASHER, SPACER
27	2	3104901	.75" ID 1.00" OD BRONZE BUSHING	58	2	3104903	1.00" ID 1.25" OD BRONZ BUSHING
28	4	7352301	CAP, END 2 X 3	59	2	7422003	LABEL, MOVING PARTS
29	8	7352201	CAP, END 1-1/2 X 2	60	4	3251200	SCREW, M10 X1.5 X 35MM UNS HEX
30	12	3236204	SCREW, M10 X1.5 35MM	61	1	3237402	PLUG, HOLE
31	2	74221xx	PAD, BACK 15 X 11-1/4	62	1	7806001	LABEL, PSHAD 1-9 CURVED

PSHADSE HIP ADDUCTION 5LB INCREMENT WEIGHT ASSEMBLY - 7446501

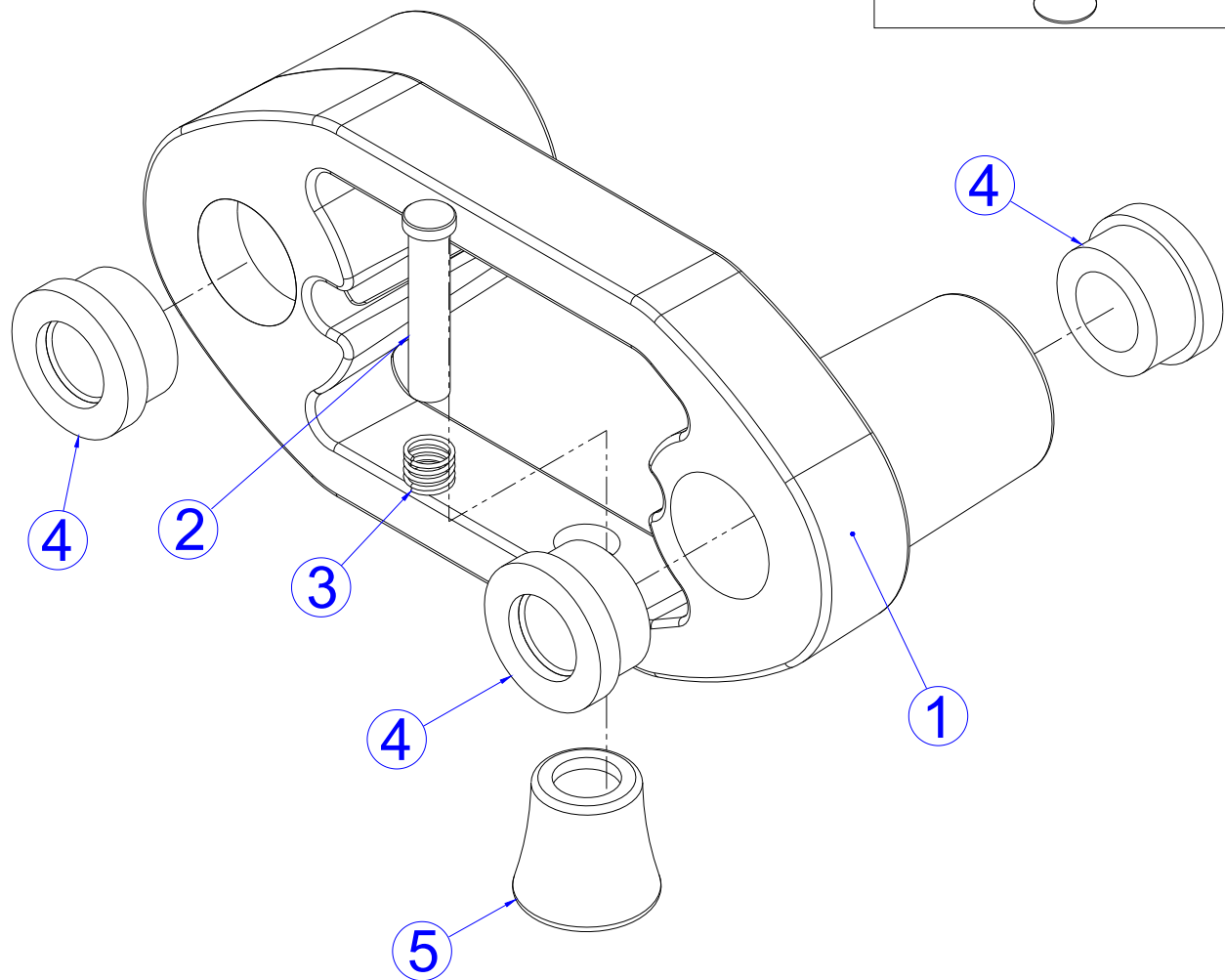
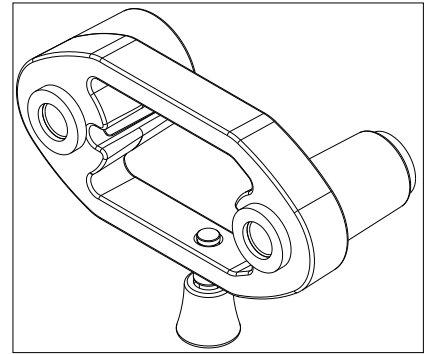

ITEM NO	QTY	PART NO	DESCRIPTION
1	1	7446602	BODY, 5LB INCREMENT WEIGHT
2	1	7446901	PIN, RETAINING
3	1	7447001	SPRING, COMPRESSION
4	3	7560001	BUSHING, MTS, INC WEIGHT
5	1	7351401	KNOB, TULIP STYLE

PSHADSE HIP ADDUCTION INCREMENT WEIGHT W/STRIKER - 7415101

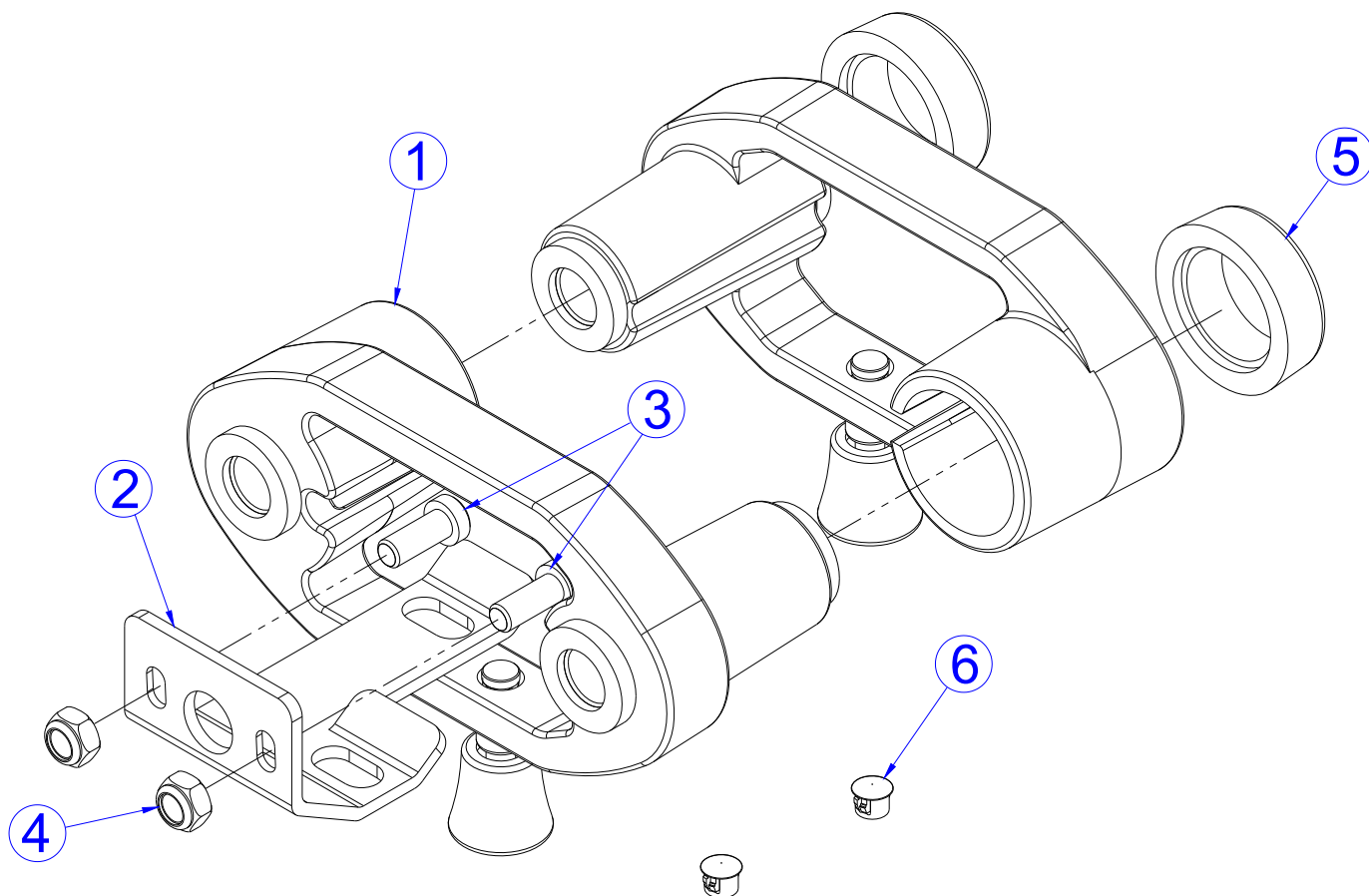
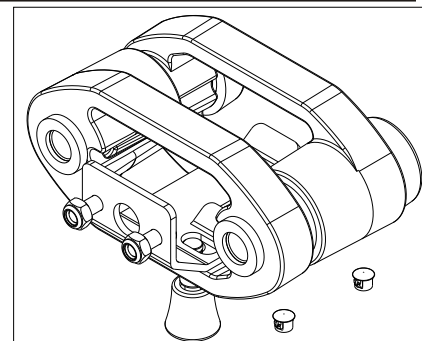

ITEM NO	QTY	PART NO	DESCRIPTION
1	2	7446501	ASSY, 5LB INCREMENT WEIGHT
2	1	8002601	PLATE, INCR. WT STRIKER
3	2	3236202	SCREW, M10 X1.5 25MM
4	2	3236801	NUT, M10 HEX NYLOCK SS
5	2	7767601	BUMPER, PS INCREMENT WT
6	2	3237401	PLUG, 7/16" HOLE

PSHADSE HIP ADDUCTION WEIGHT STACK ASSY 300LB - 7353501

WEIGHT STACK LABELS

PART NO.	DESCRIPTION
7987201	LABEL, 300 LB STACK
7987401	LABEL, 138 KG STACK

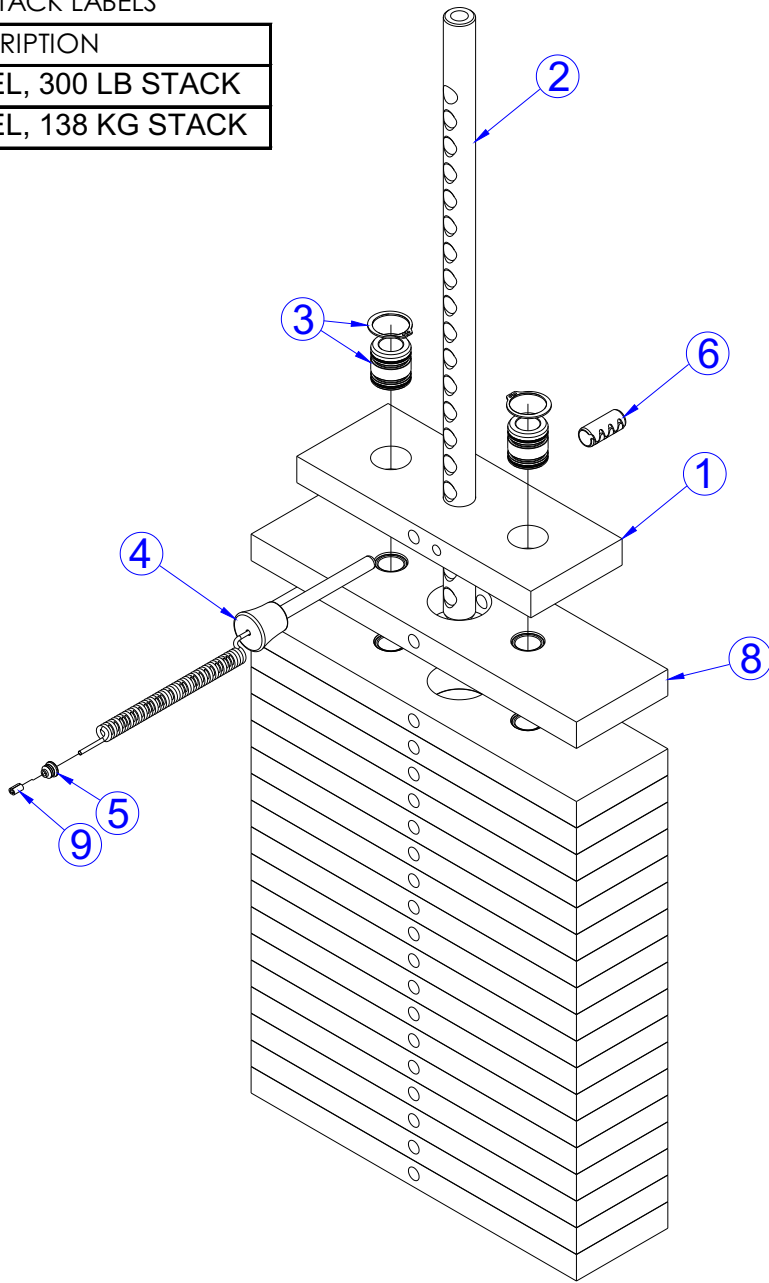
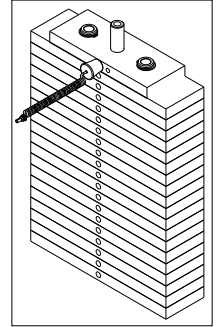

ITEM NO.	QTY.	PART NO.	DESCRIPTION
1	1	7353901	HEADPLATE, WT. STACK
2	1	7356600	STEM, PRO2 19 HOLE
3	2	7338001	BUSHING, HEADPLATE
4	1	7353001	ASSY, SELECTOR PIN
5	1	7356501	PLUG, LANYARD ATTACHMENT
6	1	3236001	BUSHING, SPRING PIN
8	19	7353801	ASSY, 15 LB PLATE
9	1	7523601	CRIMP, CABLE

PSHADSE HIP ADDUCTION REAR SHROUD KIT STD-SHORT - 7415201

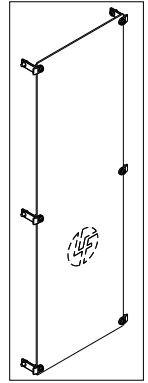
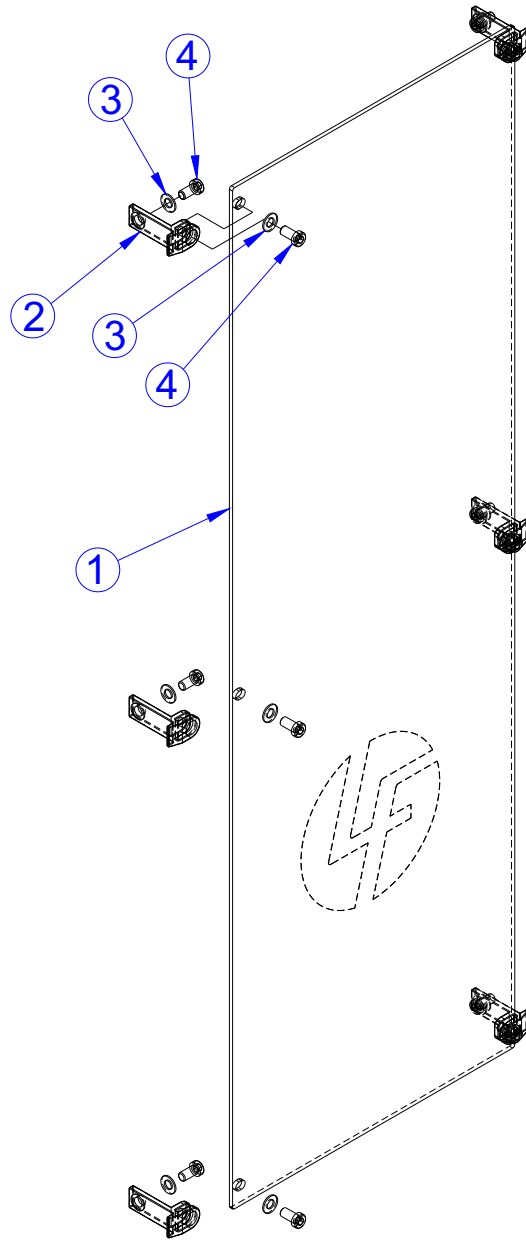

ITEM NO.	QTY.	PART NO.	DESCRIPTION
1	1	7376801	SHIELD, PS REAR
2	6	7655301	BRACKET, PS REAR SHIELD
3	12	3236601	WASHER, 3/8 SAE SS
4	12	3236201	SCREW, M10 X1.5 20MM

PSHADSE HIP ADDUCTION OPTIONAL FULL SHROUD KIT STD-SHORT - 7581101

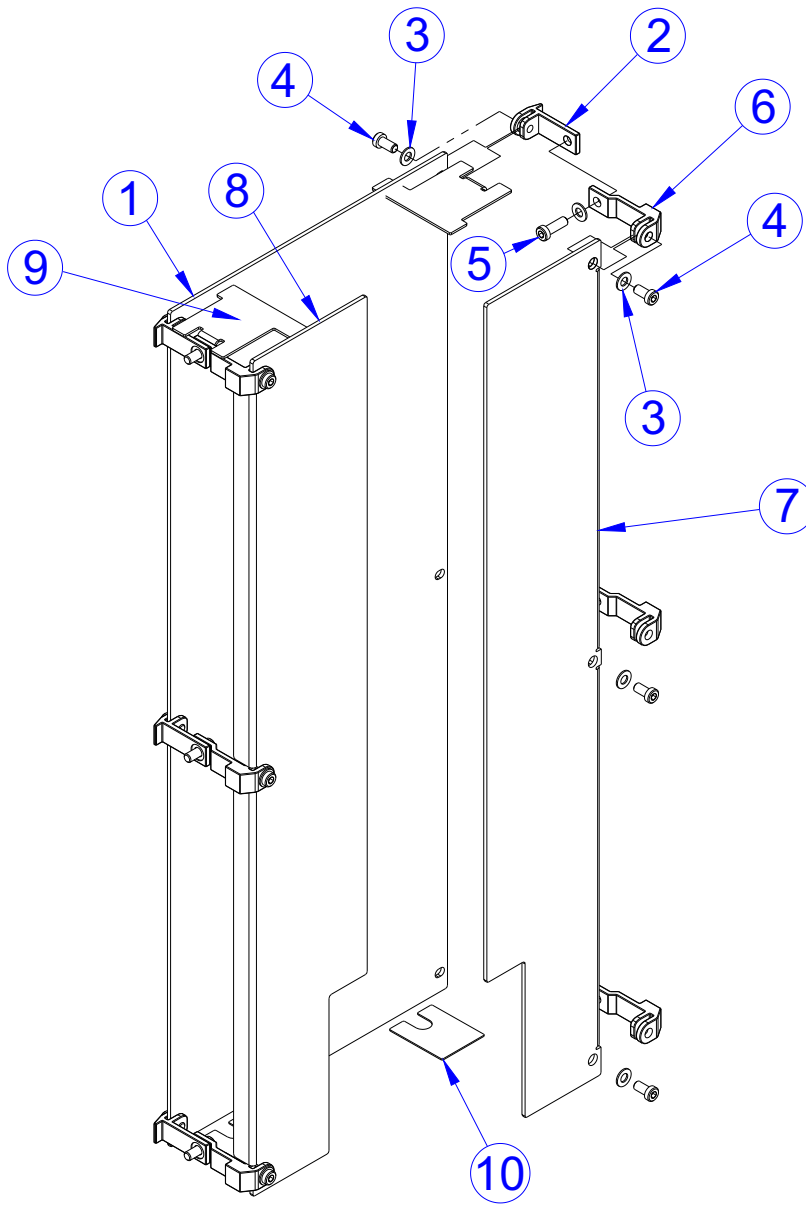

ITEM NO.	QTY.	PART NO.	DESCRIPTION
1	1	7376801	SHIELD, PS REAR 42.5
2	6	7655301	BRKT, PS REAR SHIELD
3	18	3236601	WASHER, 3/8 SAE STAINLESS STEEL
4	12	3236201	M10 X 1.5 X 20 HXS SOC CS SS
5	6	3236203	M10 X 1.5 X 30 HXS SOC CS SS
6	6	7376601	BRACKET, PS FRONT SHIELD
7	1	7544101	SHIELD, PSHAB/HAD FRONT RHT
8	1	7582301	SHIELD, PSHAB/HAD FRONT LFT
9	2	7657401	PLATE, PRO2 SHROUD SPCR
10	2	7570901	PLATE, PS SHIELD STAND-OFF

PSHADSE HIP ADDUCTION IMAGE

