

iHome™

Model iH12
**Dual Alarm Cube Clock
Radio For Your iPod**

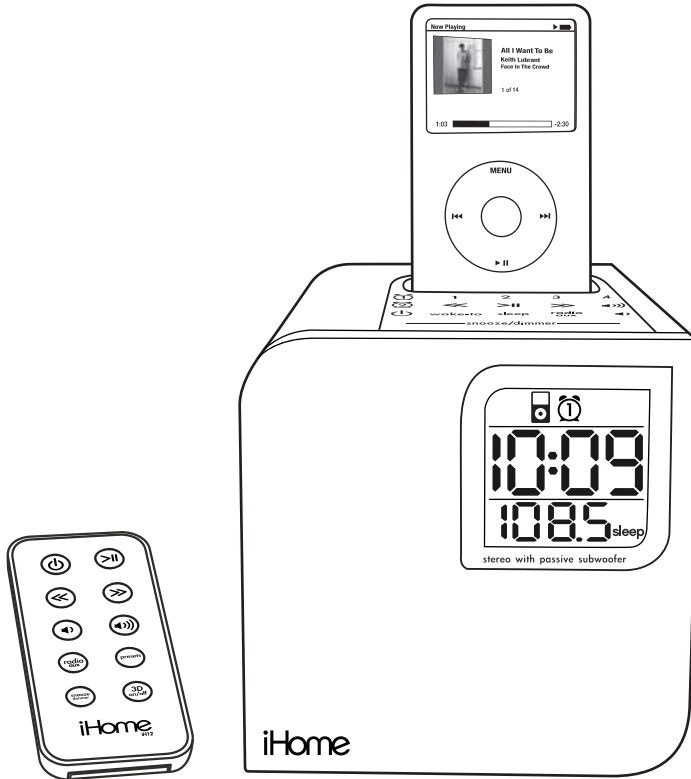

Questions? Visit www.ihomeaudio.com

Table of Contents

Quick Start	1
Controls and Indicators	2
iH12 Display	3
Install Clock Backup Battery	3
Using The Remote Control Unit	4
Install/Replace the Remote Control Battery To check for iPod compatibility	
Setting Up the iH12	5
Setting Time and Calendar	
Using the Alarm	6
Charging your iPod	6
Listening to iPod	7
Listening to non-docking iPod or other portable audio devices	7
Dimme Operation	7
Listening to Radio	8
Sleep Operation	8
Click Sound Operation	8
3D Sound Operation	8
A Consumer Guide to Product Safety	9
Trouble Shooting	10
Solución De Problemas	11
Warranty Information	12

Maintenance

- Place the unit on a level surface away from sources of direct sunlight or excessive heat.
- Protect your furniture when placing your unit on a natural wood and lacquered finish. A cloth or other protective material should be placed between it and the furniture.
- Clean your unit with a soft cloth moistened only with mild soap and water. Stronger cleaning agents, such as Benzine, thinner or similar materials can damage the surface of the unit.

FCC Information

This device complies with part 15 of the Federal Communications Commission Rules. Operation is subject to the condition that this device does not cause.

Quick Start

1:power

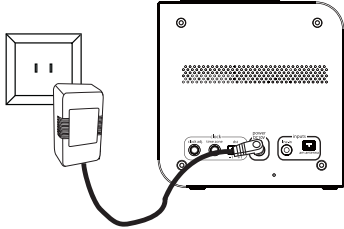

Attach AC adaptor cable to jack on back of the iH12 and plug the other end into a wall socket.

2:inserts

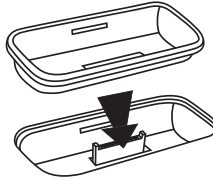

Select the dock insert for your iPod model from the table below and place insert in dock.
Never dock an iPod without an insert in place.

3:iPod

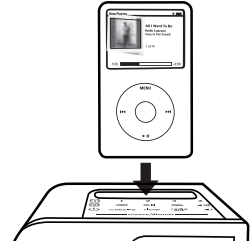

Insert iPod into dock with proper insert (iPod must not be in a skin or case). iPod will charge while docked. Press the Play Button on the iH12 to play iPod.

Use this insert	iPod Touch insert 14	3rd Gen nano insert 13	thin iPod with video (30 GB) Insert 9	iPod with video (60,80 GB) Insert 10
For this iPod	iPod Touch	3rd Gen nano	thin (30 GB) iPod with video thin (80GB) iPod classic	thick (60, 80 GB) iPod with video thick (160 GB) iPod classic

NOTE: If the insert for your iPod isn't listed, please visit an Apple store or www.ihomeaudio.com to purchase the proper insert.

Controls and Indicators

Top panel

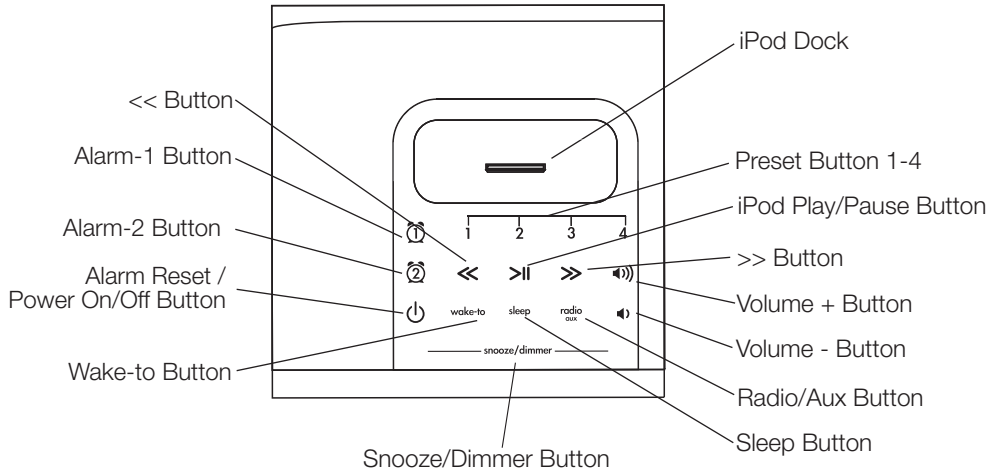

Front panel

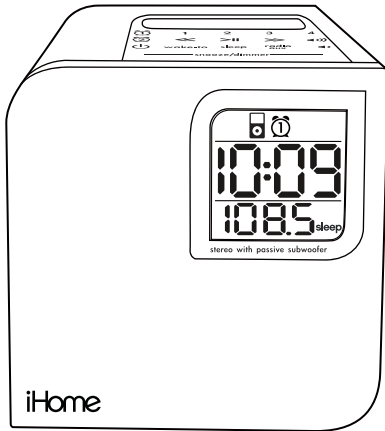

Back panel

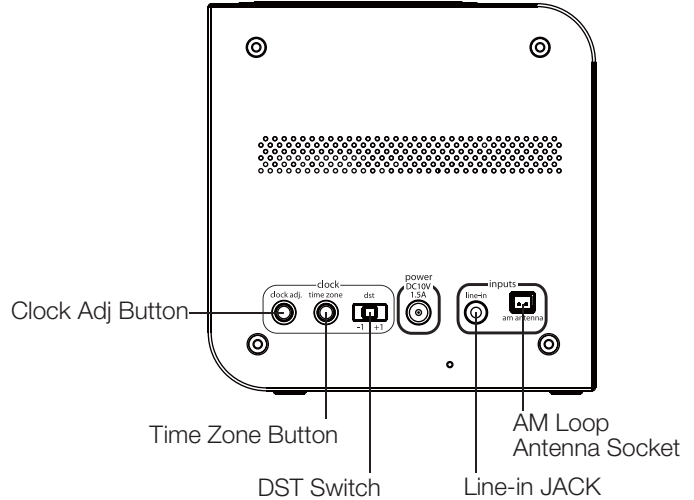

iH12 Display

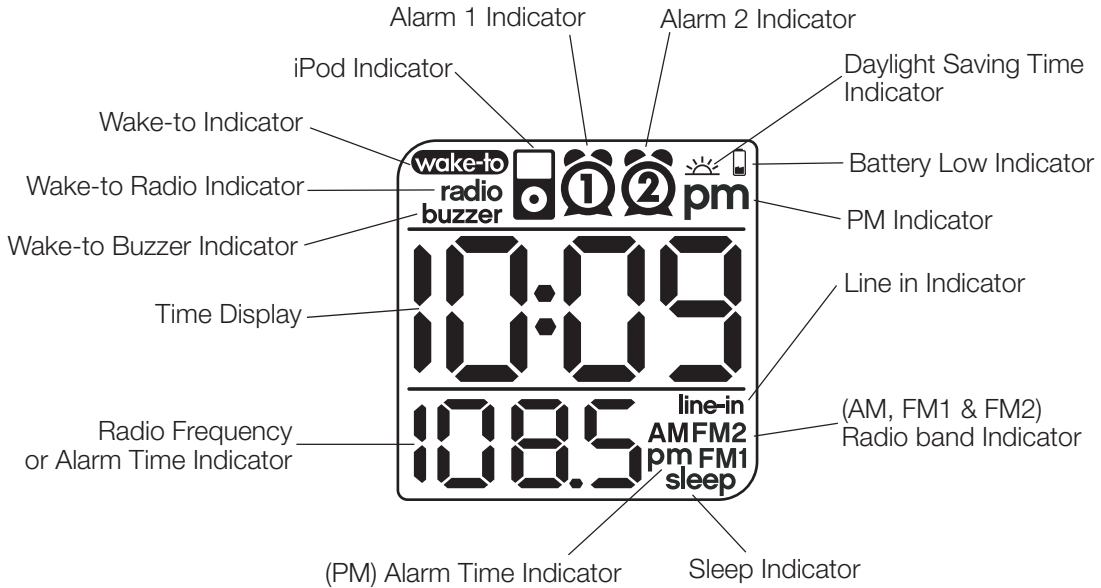

Install Clock Backup Batteries

The iH12 uses 2 alkaline “AA” batteries to provide continuous alarm operation and clock settings in the event of a power failure. If the backup batteries have been installed and a power failure occurs or the AC cord is accidentally disconnected, the display backlight will not remain lit, but current time and alarm time settings will be temporarily maintained. Otherwise, you must reset the time and alarm settings.

1. Please make sure the AC adaptor is connected. Otherwise all settings may be lost during battery replacement.
2. Open backup battery compartment door located on the bottom of the unit.
3. Insert 2 AA batteries, checking that the polarity (+ and – ends of the battery) matches the drawing near the battery compartment. Close the compartment door.

Note: Make sure you dispose of batteries properly (see your local regulations).

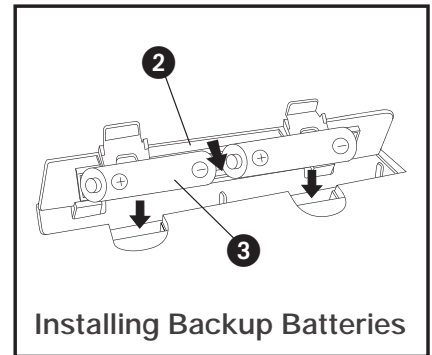

Using The Remote Control Unit

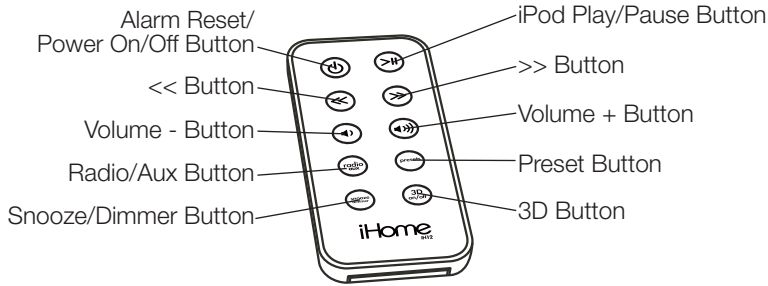

Install/Replace the Remote Control Battery

The remote control battery is already installed at the factory. When the remote control stops operating or its range seems reduced, it is time to replace the battery with a new one.

1. The battery door is located on the back end of the remote control.
2. Pull the battery door to release the battery door latch and take out the battery.
3. Insert a CR2032 battery, checking that the + and - sides of the battery matches the drawing inside the battery compartment.
4. Replace the battery door.

Note: Make sure you dispose of batteries properly (see your local regulations).

The Remote Control controls basic functions on the iH12 and certain iPod functions when the iPod is docked in the iH12. For best results, aim remote control towards the remote sensor on the upper left corner of the unit.

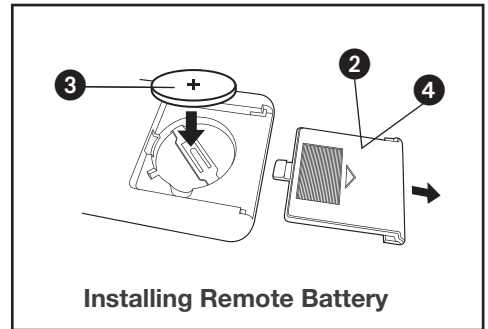

To check for iPod compatibility

iH12 is an advanced system and supports most updated iPod features. To ensure your iPod works properly with the iH12, please update your iPod firmware with the latest version, available on the Apple website (www.Apple.com).

Setting Up the iH12

This unit is a PRESET Clock/Radio: the clock is preset for the correct Eastern Standard Time at the factory. Please follow the steps below to match settings to your location.

1. Depending on your location and whether or not Daylight Saving Time (DST) is in effect, set the **DST Switch** located on the back of the unit to +1 to add 1 hour or to -1 to subtract 1 hour. When set to +1 a DST icon will appear on the display, indicating DST mode.
2. Press and hold the **Time Zone Button** located on the back of the unit until the current time zone at the lower part of the display blinks. If needed, press the << or >> **Button** to select your time zone.
3. Press **Time Zone Button** again (or if no button is pressed within 10 seconds) to exit the setting mode.
4. If the time showing is not correct, please see *Setting Time and Calendar* to set the clock.

Setting Time and Calendar

1. Press and hold the **Clock Adj Button** located on the back of the unit until the time display blinks. Press the << or >> **Button** until the current time is displayed. Holding the button for a few seconds will advance or reverse rapidly. Remember to set the correct AM or PM. An icon in the upper right hand corner of the time digits is the **PM Indicator**; there is no AM indicator.
2. Press the **Clock Adj Button** again to accept the current setting and set current year. Press the << or >> **Button** until the current year is displayed. Press the **Clock Adj Button** to confirm year setting after adjustment.
3. The display will change to show the date blinking. Press the << or >> **Button** until the current date is displayed. Holding the button for a few seconds will advance or reverse rapidly.
4. Press the **Clock Adj Button** again (or if no button is pressed within 10 seconds) to exit the time and date setting mode.

Using the Alarms

Setting the Alarms

1. Press and hold the **Alarm-1** or **Alarm-2 Button** until the alarm time blinks in the lower part of the display. Press the << or >> **Button** to set the alarm time. Holding the button for a few seconds will advance or reverse rapidly. Remember to set the correct AM or PM time.
2. Press the **Wake-to Button** to select iPod, Radio or Buzzer alarm source. You can set different alarm sources for each alarm.
3. Press the Alarm Button again or wait for 10 seconds. Alarm is now armed, indicated by the numbered alarm clock icon.

Review, Arming and Disarming Alarm (Turn Alarm Function On and Off)

1. Press **Alarm 1** (or Alarm 2) **Button** once. The unit will show the alarm time on the bottom part of the display for alarm time review.
2. During alarm review, press the Alarm 1 or Alarm 2 button again to arm or disarm the alarm. When the alarm is armed, the related alarm icon appears in display.

Resetting the Alarm to Come on the Next Day

1. When the alarm is sounding, press the **Alarm Reset/Power On/Off Button** to stop the alarm and reset it to come on the following day at the same time.

Snooze

1. Press the **Snooze/Dimmer Button** after the alarm sounds. The alarm will be silenced and come on again 9 minutes later. Snooze can be press several times during the 1 hour alarm cycle.

Sure Alarm

The iH12 has a sure alarm feature. If backup batteries are installed (see page 3) the buzzer alarm will still sound in the event of a power failure.

Charging your iPod

Note: Please make sure you are using the correct insert for your iPod (see Install iPod Insert) and that it is properly docked into the iH12. Failure to do so may damage your iPod.

1. While your iPod is docked in the unit and the unit is connected to AC power, it recharges (until fully charged). Note that non-docking iPods will NOT charge.

Listening to iPod

1. Dock the already playing iPod. The iH12 will automatically turn on and you will hear the music playing from your iPod.
Note: If the playing song/music loudness is too low on the iPod itself, iH12 may not detect iPod is in play mode. Press the Play/Pause Button on main unit or remote control twice to play it.
2. When the iPod is docked and in standby mode, press the **Play/Pause Button** on the iH12 or on the remote control to play it. The iPod Icon will appear on the display, showing iPod playing mode.
3. Press the **iPod Play/Pause Button** again to pause play; press again to resume it.
4. Press the **Volume+** and **Volume- Button** on the iH12 or on the remote control to adjust the system volume.
5. Press **>>** or **<< Button** on the iH12 or on the remote control to go to the next or previous track. Press and hold while track is playing for high speed forward or reverse music search of the current track.
6. To turn off the unit, press the **Alarm Reset/Power On/Off Button** on the iH12 or on the remote control to turn it off. Your iPod will continue charging while in the dock.

Listening to non-docking iPod or other portable audio devices

If you are using an iPod without a docking port or other MP3 player or portable audio device, you can play it through the iH12 via the Line-in Jack.

1. Plug one end of an audio patch cord (**available at www.ihomeaudio.com**) into the headphone or line-out jack on your device and the other end of the patch cord into the iH12 Line-in Jack, located on the back of the unit.
2. Press the **Radio/Aux Button** on the iH12 or on the remote until the Line-in Icon appears on the right hand lower corner of the display, indicating Line-in playing mode.
3. Turn on and play your device.
4. Press the **Volume+** and **Volume- Button** on the iH12 or on the remote control to adjust the system volume. You may need to adjust your device volume, too.
5. To turn off the unit, press the **Alarm Reset/Power On/Off Button** on main unit or remote control to turn it off. Please remember to turn off your device, too.

Dimmer Operation

During normal operation, press the Snooze/Dimmer Button to control the brightness of the LCD display.

Listening to Radio

Setting up Antenna

1. Plug the AM antenna cable into the **AM Loop Antenna Socket** on the back of unit. Move antenna 12" away from unit for best reception.
2. Extend FM wire antenna fully for best reception. Do not strip, alter or attach to other antennas.

Tuning and Playing the Radio

1. Press the **Radio Button** to select radio play mode. Press as needed to select AM, FM1 or FM2 radio band.
2. Press << or >> **Button** to tune radio to a desired station.
3. To memorize the current station as a preset, press and hold **Preset Button** 1, 2, 3 or 4. Repeat step 1-3 to preset up to 12 stations (4 AM and 8 FM). To listen to a preset station at any time, simply press the desired preset button.
4. Press the **Volume+** and **Volume-** **Button** on the iH12 or on the remote control to adjust the system volume.
5. To turn off the unit, press the **Alarm Reset/Power On/Off Button** on the iH12 or on the remote control to turn it off.

Sleep Operation

Sleep mode lets you sleep to your iPod or the radio, gradually lowering the volume until the unit shuts off at the selected time.

1. Press the **Sleep Button** to enter sleep mode. The **Sleep Icon** will appear on the display to indicate the unit is in sleep mode. The unit will automatically turn off after the selected time. Sleep mode has a Gentle Sleep feature which gradually lowers the volume 15 seconds before auto power off.
2. You can adjust the sleep timer from 120, 90, 60, 30 or 15 minutes by pressing the **Sleep Button** again.
3. When the display changes back to show the real time, press the **Sleep Button** once to show the sleep time remaining. Pressing it again will change the sleep time to the next lowest increment.
4. The iH12 has independent volume setting for sleep mode so you can adjust the sleeping volume without affecting the alarm volume. Press the **Volume+** and **Volume-** **Button** on main unit or remote control to adjust the sleep volume. The sleep volume will remain at that level the next time you enter sleep mode until controls are changed.
5. To stop listening at any time, press the **Alarm Reset/Power On/Off Button** on the iH12 or on the remote control to turn it off.

Click Sound Operation

During normal operation, press and hold the **Wake-to Button** to set button click sound on or off. After the display shows "CLC", press << or >> **Button** to set click sound on or off, then wait around 5 seconds to exit the setting mode.

3D Sound Operation

Repeatedly press the **3D Button** on the remote to set 3D wide sound effect on or off, then wait around 5 seconds to exit the setting mode.

IMPORTANT SAFETY INSTRUCTIONS

When used in the directed manner, this unit has been designed and manufactured to ensure your personal safety. However, improper use can result in potential electrical shock or fire hazards. Please read all safety and operating instructions carefully before installation and use, and keep these instructions handy for future reference. Take special note of all warnings listed in these instructions and on the unit.

1. **Water and Moisture** – The unit should not be used near water. For example: near a bathtub, washbowl, kitchen sink, laundry tub, swimming pool or in a wet basement.
2. **Ventilation** – The unit should be situated so that its location or position does not interfere with its proper ventilation. For example, it should not be situated on a bed, sofa, rug or similar surface that may block ventilation openings. Also, it should not be placed in a built-in installation, such as a bookcase or cabinet, which may impede the flow of air through the ventilation openings.
3. **Heat** – The unit should be situated away from heat sources such as radiators, heat registers, stoves or other appliances (including amplifiers) that produce heat.
4. **Power Sources** – The unit should be connected to a power supply only of the type described in the operating instructions or as marked on the appliance.
5. **Power-Cable Protection** – Power supply cables should be routed so that they are not likely to be walked on or pinched by items placed upon or against them. It is always best to have a clear area from where the cable exits the unit to where it is plugged into an AC socket.
6. **Cleaning** – The unit should be cleaned only as recommended. See the Maintenance section of this manual for cleaning instructions.
7. **Objects and Liquid Entry** – Care should be taken so that objects do not fall and liquids are not spilled into any openings or vents located on the product.
8. **Attachments** – Do not use attachments not recommended by the product manufacturer.
9. **Lightning and Power Surge Protection** – Unplug the unit from the wall socket and disconnect the antenna or cable system during a lightning storm or when it is left unattended and unused for long periods of time. This will prevent damage to the product due to lightning and power-line surges.
10. **Overloading** – Do not overload wall sockets, extension cords, or integral convenience receptacles as this can result in a risk of fire or electric shock.
11. **Damage Requiring Service** – The unit should be serviced by qualified service personnel when:
 - A. the power supply cable or plug has been damaged.
 - B. objects have fallen into or liquid has been spilled into the enclosure.
 - C. the unit has been exposed to rain.
 - D. the unit has been dropped or the enclosure damaged.
 - E. the unit exhibits a marked change in performance or does not operate normally.
12. **Antenna** – Do not connect an external antenna to the unit (other than that provided).
13. **Periods of Nonuse** – If the unit is to be left unused for an extended period of time, such as a month or longer, the power cable should be unplugged from the unit to prevent damage or corrosion.
14. **Servicing** – The user should not attempt to service the unit beyond those methods described in the user's operating instructions. Service methods not covered in the operating instructions should be referred to qualified service personnel.

Questions? Visit www.ihomeaudio.com

Trouble Shooting

Symptom	Possible Problem	Solution
Unit doesn't respond (no power)	AC adaptor isn't plugged to a wall outlet or the connector is not plugged into the power supply jack on the back of the unit	Plug the AC adaptor into a wall outlet and plug the connector into the power supply jack on the unit
	Wall outlet is not functioning	Plug another device into the same outlet to confirm the outlet is working
iPod cannot dock properly	Using no or wrong iPod insert	Make sure the dock insert is the proper fit for your iPod
	iPod is not installed properly	Remove your iPod from the connector and check for any obstruction on the connectors in the dock and on your iPod. Then reseat it in the dock.
iPod does not respond to the unit	iPod is not installed properly	Remove your iPod from the connector and check for any obstruction on the connectors in the dock and on your iPod. Then reseat it in the dock.
	Your iPod software is too old	Upgrade software on your iPod. For details, visit http://www.apple.com/ipod/download
	iPod is locked up	Please make sure your iPod is working properly before docking it to the unit. Please refer to your iPod manual for details on iPod operation.
	Using 1 st or 2 nd generation iPod or other device	iH12 cannot control those iPods or other devices.
iPod didn't charge up	iPod is not installed properly	Remove your iPod from the connector and check for any obstruction on the connectors in the dock and on your iPod. Then reseat it in the dock.
	iPod is locked up/frozen	Please make sure your iPod is working properly before docking it to the unit. Please refer to your iPod manual for details.
	iPod battery has problem	
Sound is distorted	Volume level is set too high	Decrease the volume.
	Sound source is distorted	If iPod original sound source is poor quality, distortion and noise are easily noticed with high-power speakers. Try a different audio source such as a music CD.
		If you are using an iPod Shuffle or external sound source like older generation iPod, try reducing the output volume on the device itself. Also, try turning bass boost OFF.
Remote Control didn't work	Battery weak	Replace with new battery
	Remote Control is not pointed toward the IR sensor	Point the Remote Control toward the IR sensor, within 10 feet of the unit.

Solución De Problemas

Síntoma	Posible Problema	Solución
La unidad no funciona (no circula corriente eléctrica)	El adaptador de AC no está conectado al tomacorriente o el conector no está conectado a la ficha en la parte posterior de la unidad	Conecte el adaptador de AC al tomacorriente y también conecte el conector a la ficha en la parte posterior de la unidad
	El tomacorriente no funciona	Coloque otro aparato en ese mismo tomacorriente para confirmar si el que no funciona es el tomacorriente
El iPod no encastra correctamente	No ha colocado el encastre del iPod, o está utilizando el encastre incorrecto.	Verifique que el encastre sea el apropiado para su iPod
	El iPod no encastra correctamente	Quite el iPod del encastre y retire la posible obstrucción del encastre o de su iPod. Vuelva a colocar el iPod dentro del encastre.
El iPod no se comunica con la unidad	El iPod no está instalado correctamente	Quite el iPod del encastre y verifique posibles obstrucciones del encastre o de su iPod. Vuelva a colocar el iPod dentro del encastre.
	Su software es obsoleto	Renueve su software. Para mayor información, diríjase a http://www.apple.com/ipod/download
	El iPod no responde	Verifique que su iPod funcione correctamente antes de conectarlo a la unidad. Refiérase al manual de su iPod para más detalles.
	Usted tiene un iPod de primera o segunda generación, un Shuffle u otro tipo de aparato	El iH12 no puede controlar estos otros aparatos
El iPod no carga	El iPod no está instalado correctamente	Quite el iPod del encastre y retire la posible obstrucción del encastre o de su iPod. Vuelva a colocar el iPod dentro del encastre.
	El iPod está trabado/no responde	Por favor asegúrese de que su iPod funcione correctamente antes de colocarlo en el encastre. Refiérase al manual de su iPod para mayor información.
	La batería del iPod podría tener algún inconveniente	
El sonido sale distorsionado	El volumen se encuentra muy alto	Baje el volumen y no EQ
	El sonido sale distorsionado de la unidad	Si el sonido original de su iPod era de pobre calidad, las distorsiones y ruidos se harán más notables con los parlantes de alta potencia. Pruebe utilizar otra fuente de audio como un CD.
		Si está utilizando un iPod de primeras generaciones o un Shuffle, intente bajar el volumen de su aparato. También intente apagar el amplificador de bajos
El control remoto no funciona	Las baterías están gastadas	Reemplace las baterías por nuevas
	No está apuntando el control remoto hacia el iH12	Apunte el control remoto hacia el iH12 y manténgase a una distancia máxima de 10 pies de la unidad.

Limited 90-Day Warranty Information

iHome Products, a division of SDI Technologies Inc. (hereafter referred to as SDI Technologies), warrants this product to be free from defects in workmanship and materials, under normal use and conditions, for a period of 90 days from the date of original purchase.

Should this product fail to function in a satisfactory manner, it is best to first return it to the store where it was originally purchased. Should this fail to resolve the matter and service still be required by reason of any defect or malfunction during the warranty period, SDI Technologies will repair or, at its discretion, replace this product without charge (except for a \$10.00 charge for handling, packing, return UPS/postage, and insurance). This decision is subject to verification of the defect or malfunction upon delivery of this product to the Factory Service Center listed below. The product must include proof of purchase, including date of purchase. The fee for service without proof of purchase is \$20.00.

Before returning this product for service, please first replace the batteries (if applicable) with fresh ones, as exhausted or defective batteries are the most common cause of problems encountered.

If service is still required:

1. Remove the batteries (if applicable) and pack the unit in a well padded, heavy corrugated box.
2. Enclose a photocopy of your sales receipt, credit card statement, or other proof of the date of purchase, if within the warranty period.
3. Enclose a check or money order payable to the order of SDI Technologies, for the sum of \$10.00 (\$20.00 without proof of purchase).
4. Send the unit prepaid and insured, to the Factory Service Center listed below.

Consumer Repair Department

*SDI Technologies Inc.
1330 Goodyear Drive
El Paso, TX 79936-6420*

Disclaimer of Warranty

NOTE: This warranty is valid only if the product is used for the purpose for which it was designed. It does not cover (i) products which have been damaged by negligence or willful actions, misuse or accident, or which have been modified or repaired by unauthorized persons; (ii) cracked or broken cabinets, or units damaged by excessive heat; (iii) damage to digital media players, CD's or tape cassettes (if applicable); (iv) the cost of shipping this product to the Factory Service Center and its return to the owner.

This warranty is valid only in the United States of America and does not extend to owners of the product other than to the original purchaser. In no event will SDI Technologies or any of its affiliates, contractors, resellers, their officers, directors, shareholders, members or agents be liable to you or any third party for any consequential or incidental damages, any lost profits, actual, exemplary or punitive damages. (Some states do not allow limitations on implied warranties or exclusion of consequential damages, so these restrictions may not apply to you.) This warranty gives you specific legal rights, and you may also have other rights which vary from state to state.

Your acknowledgement and agreement to fully and completely abide by the above mentioned disclaimer of warranty is contractually binding to you upon your transfer of currency (money order, cashier's check, or credit card) for purchase of your SDI Technologies product.

© 2008 SDI Technologies, Inc. All rights reserved

**Questions? Visit www.ihomeaudio.com
or call 1-800-288-2792 Toll Free**

iH12-030108-0

Printed in China