

Use and Care Guide

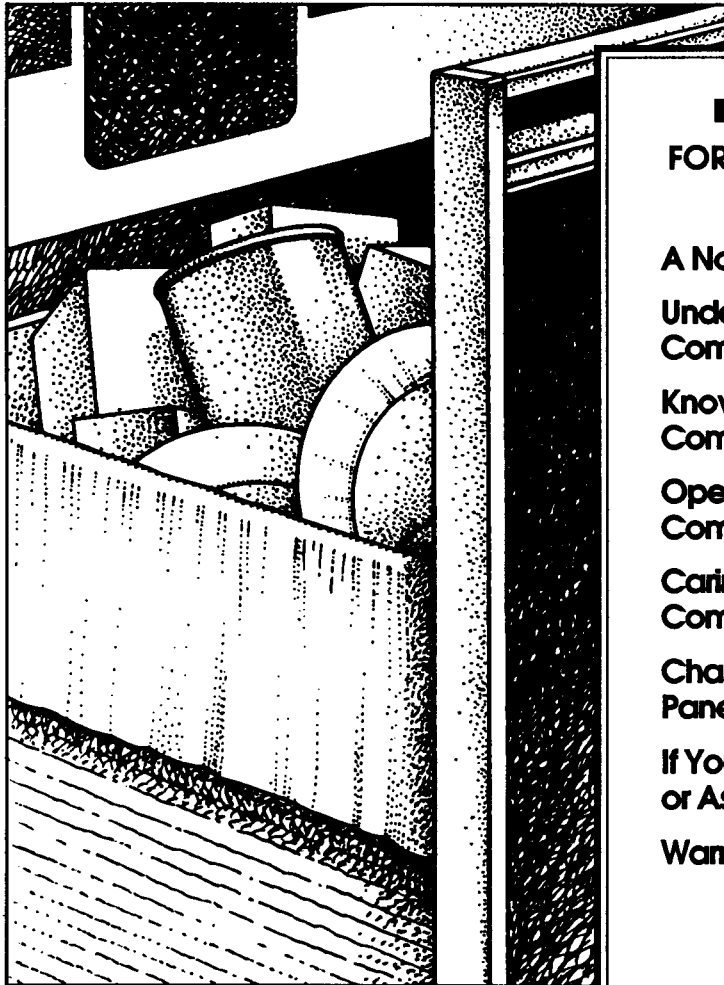

KitchenAid® FOR THE WAY IT'S MADE.™

A Note to You	2
Understanding Compactor Safety	3
Knowing Your Compactor's Features	5
Operating Your Compactor	7
Caring for Your Compactor	13
Changing Front Panels	16
If You Need Service or Assistance	17
Warranty	20

1-800-422-1230

Call with questions or comments.

KITCHENAID® 15" Trash Compactors

Models: KUCC151 KCCC151

5/94

A Note to You

Thank you!

Thank you for buying a KITCHENAID® home appliance. This world-class product is the result of years of engineering experience. To ensure reliable, trouble-free operation, please read and follow this Use and Care Guide. In it you will find valuable information to help you safely operate and maintain your appliance.

Also, please complete and mail the enclosed Product Registration Card.

Your safety is important to us.

This guide contains safety statements under warning symbols. Please pay special attention to these symbols and follow any instructions given. Here is a brief explanation of the use of the symbol.

WARNING

This symbol alerts you to such dangers as personal injury, burns, fire and electrical shock.

Our Consumer Assistance Center telephone number, 1-800-422-1230, is toll-free 24 hours a day.

If you have a question concerning your home appliance's operation, or if you need service, call our toll-free Consumer Assistance Center telephone number for help. When calling, you will need to know your appliance's complete model number and serial number. You can find this information on the model and serial number label (see diagram on page 5). Record these numbers and purchase information below. You will need this information if you require service. Keep this book and the sales slip together in a safe place for future reference.

NOTE: You must provide proof of purchase or installation date for in-warranty service.

Model Number _____ **Builder/Dealer Name** _____
Serial Number _____ **Address** _____
Date Installed _____ **Phone** _____

Understanding Compactor Safety

Grounding instructions

The compactor is for use on a single phase, 115-volt, 60 Hz, AC only 15 or 20 ampere fused and properly grounded circuit and is equipped with a grounding plug as shown below. Time delay fuse or circuit breaker is recommended. It is recommended that a separate circuit serving only this appliance be provided. For your personal safety, the compactor must be grounded. In the event of an electrical short circuit, grounding reduces the risk of electric shock by providing an escape wire for the electric current. This appliance is equipped with a polarized 3-prong grounding plug. It must be plugged into a correctly polarized mating 3-prong grounding type outlet, properly installed and grounded in accordance with the National Electrical Code and local codes and ordinances. No adapter should be used with this appliance.

⚠ WARNING

Electrical Shock Hazard

Do not modify the power supply plug provided with the compactor. If it will not fit the outlet, or if you are in doubt as to whether the wall outlet is properly grounded, check with a qualified electrician.

Failure to do so could result in electrical shock or personal injury.

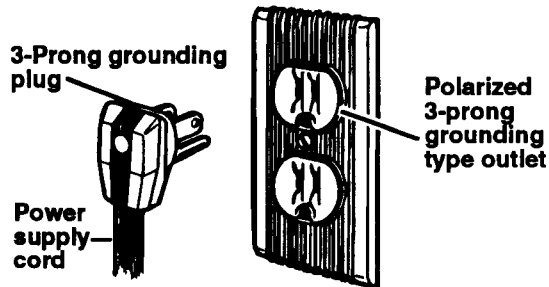

Help us help you

- Do not shove items down into the compactor with hands or feet. Let the compactor do the compacting.
- Always place glass bottles, etc., on their sides in the center of the drawer. The waste paper below and beside the bottle can help keep broken glass near center of bag.
- Do not install or store compactor where it will be exposed to the weather.
- You are responsible for making sure that your compactor:
 - Is used only for jobs normally expected of home compactors.
 - Is properly installed and leveled on a floor that can support its weight.
- Do not use a freestanding compactor as a counter for electrical cooking appliances nor as a cutting board.
- Do not set hot pans, etc., on a freestanding compactor's top. Do not spill any liquids on a freestanding compactor's top.

IMPORTANT SAFETY INSTRUCTIONS

WARNING

To reduce the risk of fire, electrical shock, or injury when using your compactor, follow basic precautions including the following:

- Read all instructions before using the compactor.
- Close supervision of children is necessary when the compactor is used near children.
- Do not allow compactor to be used as a toy, or to run unattended at any time. Lock the Key-Switch or Key-Knob when not in use and store key out of reach of children.
- Do not touch moving parts.
- Have appliance examined, repaired or adjusted by an authorized serviceman.
- Do not compact:
 - lighted cigarettes, cigars or other hot or burning items.
 - any container or aerosol can containing insecticide, hair spray, paint, engine starting fluid or other poisonous, toxic, or explosive products.
 - volatile flammable material such as oily rags, thinner, etc., which would create a fire hazard or explosion.
- Do not take apart this appliance. Incorrect reassembly can cause electric shock when subsequently used.
- Use only for intended use as described in this manual. Do not use other than manufacturer's recommended attachments.
- Never lift the bag by the sides. Broken glass or other sharp objects in the bag can cause injury.
- This compactor is designed for household use only.
- Unplug compactor from electrical outlet before servicing.
- The compactor must be electrically grounded. See the grounding instructions.
- Do not overload trash bag with heavy material such as glass.
- Never operate the compactor if:
 - it is not working right.
 - it is damaged.
 - parts are missing.
 - the cord set, plug or motor is damaged in any manner.
- Never use or store flammable fluids (dry cleaning solvents, gasoline, kerosene, etc.) in or near your compactor. These substances give off vapors that can create a fire hazard or explosion.
- See Installation Instructions.

–SAVE THESE INSTRUCTIONS–

Knowing Your Compactor's Features

This section contains captioned illustrations of your appliance. Use them to become familiar with the location and appearance of all parts and features.

NOTE: The drawings in this book may vary from your compactor. They are designed to show the different features of all models covered by this book. Your model may not include all features. Page numbers are included next to some features. Refer to those pages for more information about the features.

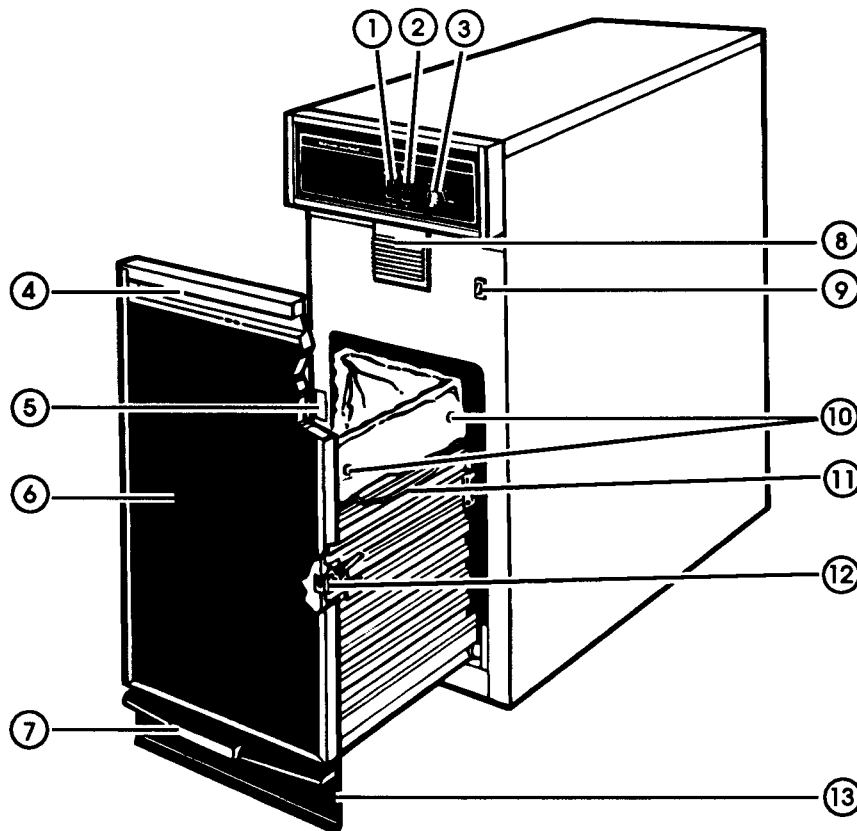

- | | |
|--------------------------------------|--|
| 1. Solid pack switch (p. 9) | 7. Touch-toe bar drawer opener (p. 7) |
| 2. Charcoal air filter switch (p. 9) | 8. Activated charcoal air filter (p. 9,13) |
| 3. Key-knob start switch (p. 8) | 9. Drawer monitor switch |
| 4. Drawer handle (pps. 7, 15) | 10. Bag retainer buttons (p. 10,11) |
| 5. Model and serial number label | 11. Bag carrier handle (p. 10,11) |
| 6. Color front panel pack (p. 15) | 12. Lever-action lock (p. 10) |

Control panel

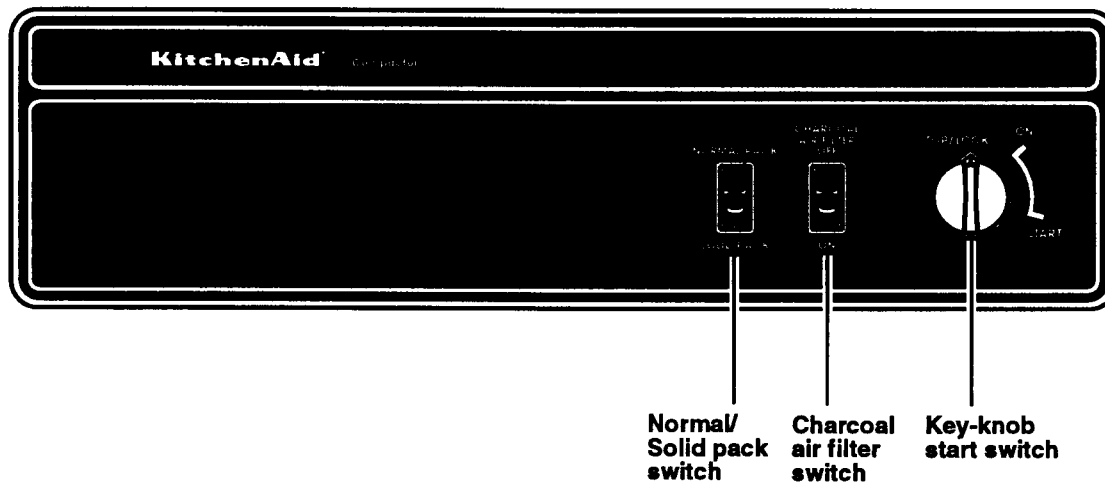

Operating Your Compactor

This section tells you how to operate the compactor. Operating your compactor properly enables you to obtain the best possible results.

IN THIS SECTION		Page	Page
Loading your compactor	7	Using the charcoal air filter	9
Starting your compactor	8	Removing a filled bag	10
Stopping your compactor	8	Installing a new bag	11
Using solid pack cycle	9	How your compactor works	12

Loading your compactor

⚠ WARNING

Fire or Personal Injury Hazard

- Do not compact any container, aerosol cans or cloths which might contain insecticide, hair spray, engine starting fluid, paints, liquids, thinners or any other poisonous or explosive products. Failure to do so may result in a fire hazard or explosion.
- Broken glass or sharp edges may be present in trash. Do not shove items down into compactor with feet or hands. Failure to do so may result in personal injury.

1. Lift and pull the handle or press the Touch-Toe Bar to open the drawer. Pressing the toe bar opens the container only 3-6" (depending on the load).

2. Place trash in compactor.

NOTE:

- Wrap or cover wet or messy trash.
- Load bottles or cans on their sides in the **center** of the drawer.
- Do not compact items that may develop offensive odors such as raw meat, fish, grapefruit rinds, disposable diapers, or personal hygiene items.

3. Push drawer in until it stops.

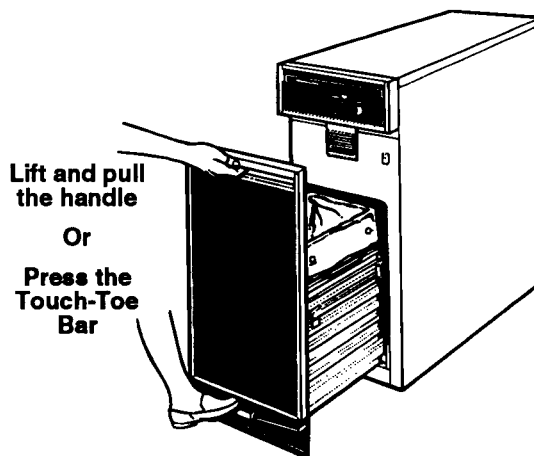

Starting your compactor

1. Set Normal/Solid Pack switch to NORMAL.
2. Turn the Key-Knob to START and then release the Key-Knob.
3. Compactor stops after completing cycle.

Note: For safety, when the compacting cycle is done, turn the Key-Knob to STOP/LOCK. Remove the Key-Knob and store it in a safe place out of children's reach.

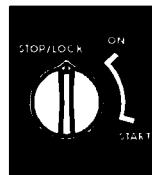
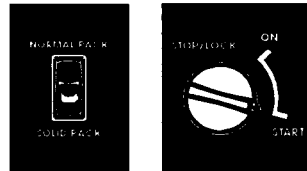

Stopping your compactor

You can stop the compactor anytime during the cycle.

1. Turn the Key-Knob to STOP/LOCK.
2. Turn the Key-Knob to ON. The compacting ram will rise.
3. If needed, you can open the door when the compacting ram stops rising.

Note: For safety, when the compacting cycle is done, turn the Key-Knob to STOP/LOCK. Remove the Key-Knob and store it in a safe place out of children's reach.

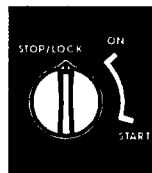
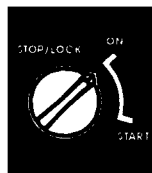
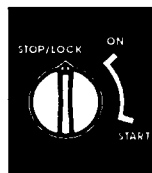

Using solid pack cycle

The Solid Pack cycle extends the use of a bag by putting constant pressure on the trash to keep it from springing back. Regular use of the Solid Pack cycle can increase bag capacity up to 20%.

During the Solid Pack cycle, the ram will stay in the **down** position for extra compacting. While the Solid Pack cycle is operating, a red indicator shows on the Solid Pack switch. The drawer **cannot** be opened when the ram is down. For best results, use the Solid Pack cycle for at least ½ hour at a time.

To use Solid Pack cycle

1. Set Normal/Solid Pack switch to **SOLID PACK**
2. Turn the Key-Knob to **START** and then release the Key-Knob.
3. To raise the compacting ram, turn the Key-Knob to **START** or set Normal/Solid Pack switch to **NORMAL**.

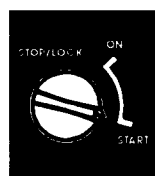
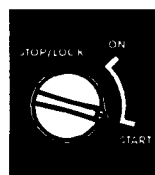

or



NOTE: For safety, when the compacting cycle is done, turn the Key-Knob to **STOP/LOCK**. Remove the Key-Knob and store it in a safe place out of children's reach

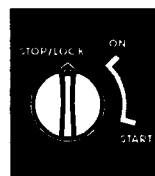

NOTE: Fully compacted trash bags will be heavier than normal. Handle with care.

Using the charcoal air filter

The fan powered Charcoal Air Filter absorbs and minimizes odor. The degree of odor in the compactor depends on the type of trash placed in it. The length of time before the

filter needs to be replaced varies with the type of trash compacted. Under normal use the filter should be replaced once or twice per year.

Operating Your Compactor

To use the filter

1. Set the Charcoal Air Filter switch to ON. The fan creates air movement in the compactor for odor removal.

NOTE: The Charcoal Air Filter continues to work even when the Key-Knob is in the STOP/LOCK position.

2. Set the Charcoal Air Filter switch to OFF to turn off the fan.

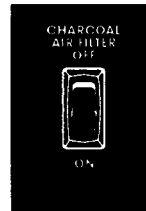

Removing a filled bag

When the trash is compacted to the top of the drawer, remove the bag. If the bag is too heavy, compact less trash before emptying in the future.

WARNING

Personal Injury Hazard

Sharp objects may protrude through bag after removal from compactor. Handle bag carefully.

Failure to do so may result in personal injury.

1. Pull the drawer completely open.
2. Remove top of bag from bag retainer buttons. Pull up all 4 bag cuffs.
3. Close bags with twist ties provided.
4. Push lever-action lock down and tilt drawer side open.

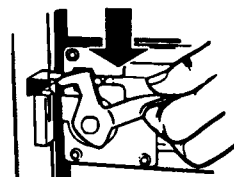
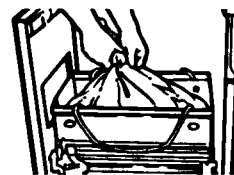

5. Lift bag by bag carrier handles.

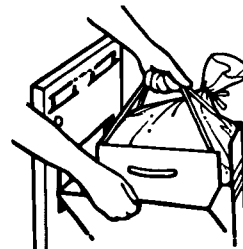

Installing a new bag

1. Push side of drawer closed. Latch the drawer side by pushing the lever-action lock up.

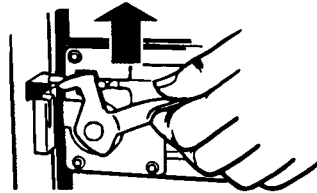

2. Fit the bag carrier in the drawer.

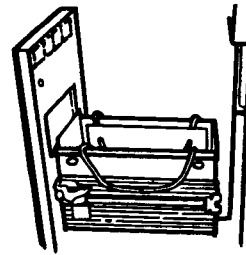

3. Place folded bag into the drawer. Open bag and pull top edges over the drawer top.

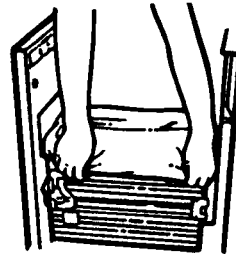

4. Lock bag in place by pulling the 4 prepunched holes over the bag retainer buttons. Holes will expand over the buttons without harming the bag.

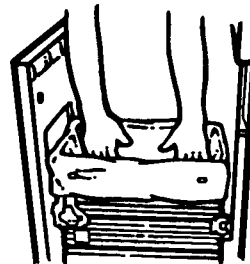

5. Press inside of bag against the drawer bottom, sides and corners for a smooth fit.

NOTE: A special type of bag has been designed for use in the compactor. Do not use grocery bags, plastic waste containers, etc., instead of the compactor bags. They are not strong enough or large enough to hold compacted trash.

To order additional bags, contact your local KitchenAid dealer or call the KitchenAid Consumer Assistance Center at 1-800-422-1230.

How your compactor works

The compacting ram does not go to the drawer bottom. You will not see compacting of the first few loadings.

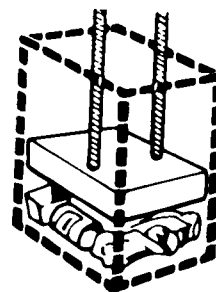

Compaction starts after the drawer is about $\frac{1}{3}$ full. You may hear a noise when glass breaks. **Strong glass bottles may not break at all.**

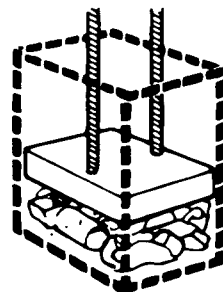

The trash in a full compactor bag will be about $\frac{1}{4}$ the size of its original bulk.

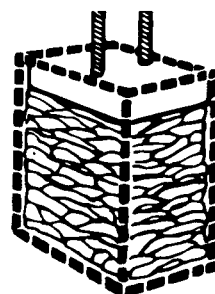

Load bulky trash, bottles and cans in the **center** of the drawer. Bottles or cans not placed in the center may become caught between the ram and the drawer. The Drawer Monitor switch senses a "misload" and causes the ram to return to the "up" position without compacting.

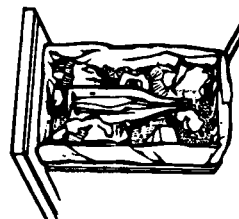

Caring for Your Compactor

Your new compactor is designed to give you many years of dependable service. However, there are a few things you are expected to do in order to maintain your compactor properly. This section will tell you how to clean and care for your compactor.

Changing the charcoal air filter

1. Insert fingertips in the Air Filter Cover and pull until the side cover tabs release. Lift cover to release the bottom tabs.
2. Remove the Air Filter by pulling the top edge of the filter. The filter should pull out easily. Throw away used filter.
3. To replace, push the replacement filter into place. Insert the bottom tabs of the Air Filter Cover, then snap the side tabs into place.

To order replacement charcoal air filters (part number 4151750), complete and return order form included with your compactor. For additional ordering information, call the KitchenAid Consumer Assistance Center at 1-800-422-1230.

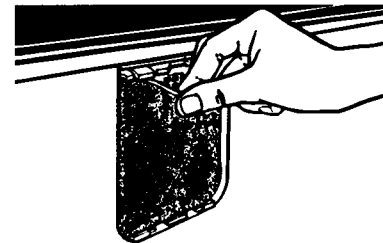
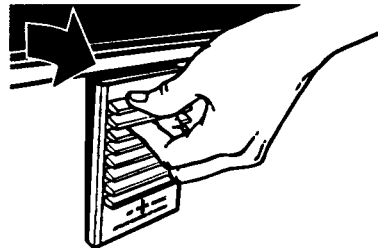

Cleaning the compactor

Before cleaning the compactor, turn the Key-Knob to the STOP/LOCK position and remove.

If you will be away for more than a couple of days, remove the compactor bag. Lock the compactor and remove the Key-Knob. Store the Key-Knob in a safe place.

⚠ WARNING

Personal Injury Hazard

Wear protective gloves when cleaning the inside of the compactor.

Failure to do so may result in cuts if bits of broken glass are present.

Cleaning exterior surfaces

Wipe with warm, sudsy water and a damp cloth. Rinse. Dry with a soft cloth.

Wipe up spills right away. Some foods can damage the finish if left on the compactor surface.

Cleaning inside the drawer

1. Wear protective gloves. There may be bits of glass in the drawer.
2. Remove the bag. (See “Removing a filled bag” on page 10.)
3. Press lever-action lock down.
4. Hold lever-action lock and tilt side of drawer until the lock clears the drawer front.

NOTE: Drawer side can be removed by tilting it out, then lifting out.

5. Wash with a damp cloth using warm, soapy water. Rinse and dry with a soft cloth.
6. If drawer side was removed, slide it back into the tilted position.
7. Press the lever-action lock down while pressing the side to the upright position.
8. Latch the drawer side by pushing the lever-action lock up.

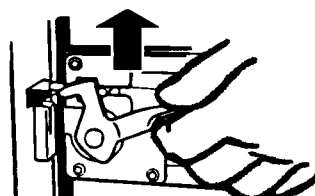
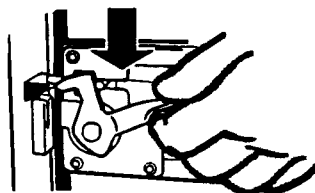

Cleaning inside the cabinet

1. Wear protective gloves. There may be bits of glass in the cabinet.
2. Pull the drawer out until it stops.
3. Note the tracks in which the drawer rollers move.
4. Lift the front to clear the drawer stops.
5. Grasp the drawer on the sides.
6. Pull it out the rest of the way.
7. Set it down gently.
8. Vacuum inside of cabinet. Liquid spills or wet trash should be cleaned up by hand, or use a vacuum designed to pick up liquids.
9. Wash, rinse and dry inside.

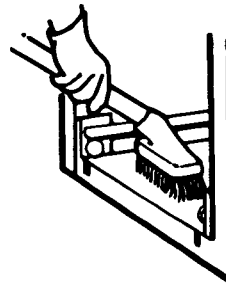
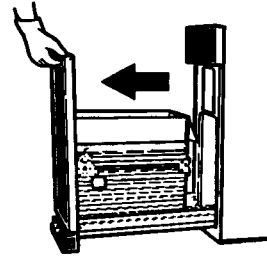

Replacing the Drawer

- Grasp the drawer sides.
- Insert the drawer rollers onto the tracks.
- Lift the drawer to clear stop tabs, then push the drawer in.

Changing Front Panels

Your new KitchenAid® compactor comes with a reversible front panel. You may choose to reverse your panel or build a custom panel. See your Installation Instructions if you want to use custom front panels.

⚠ WARNING

Personal Injury Hazard

Wear gloves and handle panels carefully.
Failure to do so can result in cuts to hands or other parts of your body.

⚠ WARNING

Electrical Shock Hazard

Disconnect electrical power supply to compactor before changing panels.
Failure to do so can result in death by electric shock.



1. Slide the drawer out until it stops.

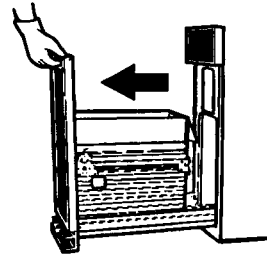

2. Remove two screws shown.
3. Wear protective gloves.
4. Remove handle.

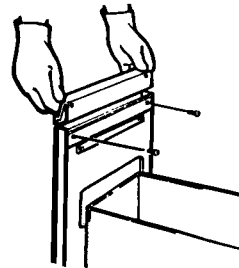

5. Install desired color panel in front, behind trim. Be careful – edges may be sharp.
6. Make sure panels are all the way down and cardboard spacer is placed in rear.
7. Replace handle and screws.
8. Slide drawer back in.

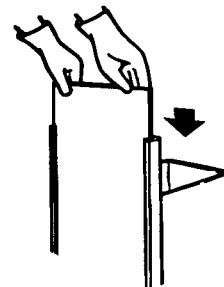

NOTE: If the two colors provided with your trash compactor do not match your kitchen decor, optional panels are available in a variety of decorator colors from your KitchenAid dealer or you may replace the color panel with your own creation (wallpaper, paneling or cabinet front.) See Installation Instructions.

If You Need Assistance or Service

1. Before calling for service ...

If your appliance fails to operate, review the following list before calling your dealer. This could save you the cost of a service call, especially for a problem that is not covered by the warranty.



Is the door closed?



Is the Normal/Solid Pack switch set to NORMAL?



Have you blown a fuse or tripped a circuit breaker?



If you need more help, check the chart below.



PROBLEM	CHECK THE FOLLOWING
Compactor does not run	<p>Is the Key-Knob turned all the way to START before it is released?</p> <p>Is the drawer completely closed?</p> <p>Is the compactor connected to a live electrical circuit with the proper voltage?</p> <p>Has a household fuse or circuit breaker blown or tripped?</p>
Drawer will not open	<p>Drawer will open only when ram is all the way up.</p> <p>To raise the ram, turn the Key-Knob to START and release.</p> <p>The drawer cannot be opened during the Solid Pack cycle. While the Solid Pack cycle is operating, a red indicator shows on the Solid Pack switch.</p>
Trash does not compact	<p>Is the drawer loaded properly? If anything gets between the ram and the drawer, the ram will return to the "up" position, without compacting.</p> <p>Drawer must be at least $\frac{1}{3}$ full before compactor will compact.</p>
Not enough compaction or force	<p>Compacting works best when only a few items are loaded. Use the compacting cycle frequently.</p>
Bottles do not break	<p>Not all bottles will break every time. Bottles will break depending on the bottle and the trash load below it.</p>

If You Need Assistance or Service

2. If you need assistance* ...

- Call KitchenAid Consumer Assistance Center:

1-800-422-1230

One of our trained consultants can instruct you in how to obtain satisfactory operation from your appliance or, if service is necessary, recommend a qualified service company in your area.

- If you prefer, write to:
Consumer Assistance Center
KitchenAid
2000 N State Route 63
Benton Harbor, MI 49022-2692

3. If you need service* ...

- Call your dealer or the repair service he recommends.
- All service should be handled locally by the dealer from whom you purchased the unit or an authorized KitchenAid servicer.
- If you are unable to obtain the name of a local authorized KitchenAid servicer, call our Consumer Assistance Center telephone number (see Step 2).

4. If you are not satisfied with the action taken:

- Contact the Major Appliance Consumer Action Panel (MACAP). MACAP is a group of independent consumer experts that voices consumer views at the highest levels of the major appliance industry.
- Contact MACAP only when the dealer, authorized servicer and KitchenAid have failed to resolve your problem.
Major Appliance Consumer Action Panel
20 North Wacker Drive
Chicago, IL 60606
- MACAP will in turn inform us of your action.

*When asking for help or service:

Please provide a detailed description of the problem, your appliance's complete model and serial numbers, and the purchase date. (See page 2.) This information will help us respond properly to your request.

Don't forget, KitchenAid offers a full line of quality home appliances.

Built-in Refrigerators	Trash Compactors	Ranges & Cooktops
Freestanding Refrigerators	Hot Water Dispensers	Microwave Ovens
50-Pound Ice Makers	Food Waste Disposers	Washers & Dryers
Dishwashers	Built-in Ovens	Mixers & Blenders

For more information on these appliances, or the one you have purchased, call our toll-free Consumer Assistance Center telephone number, **1-800-422-1230**.

KitchenAid[®] Compactor Warranty

LENGTH OF WARRANTY:	KITCHENAID WILL PAY FOR:
ONE YEAR FULL WARRANTY FROM DATE OF PURCHASE.	Replacement parts and repair labor to correct defects in materials or workmanship. Service must be provided by an authorized KitchenAid servicing outlet.
KITCHENAID WILL NOT PAY FOR:	
<p>A. Service calls to:</p> <ol style="list-style-type: none"> 1. Correct the installation of the compactor. 2. Instruct you how to use the compactor. 3. Replace house fuses or correct house wiring. <p>B. Repairs when compactor is used in other than normal home use.</p> <p>C. Damage resulting from accident, alteration, misuse, abuse, improper installation or installation not in accordance with local electrical and plumbing codes.</p> <p>D. Replacement parts or repair labor costs for units operated outside the United States.</p> <p>E. Pickup and delivery. This product is designed to be repaired in the home.</p> <p>F. Repairs to parts or systems caused by unauthorized modifications made to the appliance.</p>	

KITCHENAID DOES NOT ASSUME ANY RESPONSIBILITY FOR INCIDENTAL OR CONSEQUENTIAL DAMAGES. Some states do not allow the exclusion or limitation of incidental or consequential damages, so this exclusion may not apply to you.

This warranty gives you specific legal rights and you may also have other rights which may vary from state to state.

If you need service, first see the "If You Need Assistance or Service" section of this book. After checking "If You Need Assistance or Service," additional help can be found by calling our Consumer Assistance Center telephone number, **1-800-422-1230**, from anywhere in the U.S.A.

KitchenAid
Benton Harbor, MI, U.S.A. 49022-2692



Printed on recycled paper—
10% post-consumer waste
50% recovered materials