

***AM/FM CLOCK RADIO
with SURE-ALARM™
BATTERY BACK-UP and
NIGHT LIGHT***

OWNER'S MANUAL

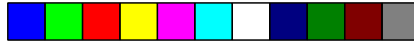

GP808

Visit our web site at www.emersonradio.com



WARNING

TO PREVENT FIRE OR SHOCK HAZARD, DO NOT USE THIS PLUG WITH AN EXTENSION CORD, RECEPTACLE OR OTHER OUTLET UNLESS THE BLADES CAN BE FULLY INSERTED TO PREVENT BLADE EXPOSURE. TO PREVENT FIRE OR SHOCK HAZARD, DO NOT EXPOSE THIS APPLIANCE TO RAIN OR MOISTURE.

 <p>The lightning flash with arrow-head symbol, within an equilateral triangle is intended to alert the user to the presence of uninsulated 'dangerous voltage' within the product's enclosure that may be of sufficient magnitude to constitute a risk of electric shock to persons.</p>	<p>WARNING RISK OF ELECTRIC SHOCK DO NOT OPEN</p> <p>CAUTION: TO REDUCE THE RISK OF ELECTRIC SHOCK DO NOT REMOVE COVER (OR BACK), NO USER SERVICEABLE PARTS INSIDE REFER SERVICING TO QUALIFIED SERVICE PERSONNEL.</p>	 <p>The exclamation point within an equilateral triangle is intended to alert the user to the presence of important operating and maintenance (servicing) instructions in the literature accompanying the appliance.</p>
--	--	---

IMPORTANT SAFETY INSTRUCTIONS

- 1.) Read these instructions.
- 2.) Keep these instructions.
- 3.) Heed all warnings.
- 4.) Follow all instructions.
- 5.) Do not use this apparatus near water.
- 6.) Clean only with dry cloth.
- 7.) Do not block any ventilation openings. Install in accordance with the manufacturer's instructions.
- 8.) Do not install near any heat sources such as radiators, heat registers, stoves, or other apparatus (including amplifiers) that produce heat.
- 9.) Do not defeat the safety purpose of the polarized or grounding-type plug. A polarized plug has two blades with one wider than the other. A grounding type plug has two blades and a third grounding prong. The wide blade or the third prong are provided for your safety. If the provided plug does not fit into your outlet, consult an electrician for replacement of the obsolete outlet.
- 10.) Protect the power cord from being walked on or pinched particularly at plugs, convenience receptacles, and the point where they exit from the apparatus.
- 11.) Only use attachments / accessories specified by the manufacturer.
- 12.) Unplug this apparatus during lightning storms or when unused for long periods of time.
- 13.) Refer all servicing to qualified service personnel. Servicing is required when the apparatus has been damaged in any way, such as power-supply cord or plug is damaged, liquid has been spilled or objects have fallen into the apparatus, the apparatus has been exposed to rain or moisture, does not operate normally, or has been dropped.
- 14.) This appliance shall not be exposed to dripping or splashing water and no object filled with liquids such as vases shall be placed on the apparatus.
- 15.) Do not overload wall outlet. Use only power source as indicated.
- 16.) Use replacement parts as specified by the manufacturer.
- 17.) The product may be mounted to a wall only if recommended by the manufacturer.
- 18.) Upon completion of any service or repairs to this product, ask the service technician to perform safety checks.

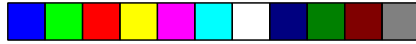

Thank you for purchasing this **Girpower** AM/FM Clock Radio with Sure-Alarm™ Battery Back Up System. It has been designed and engineered to provide you with many years of reliable operation with a minimum of care. Listen to your favorite AM/FM radio stations, wake up to the radio or an electronic buzzer alarm, sleep to music with the auto shut-off timer and use the Snooze Alarm when you need a few more minutes sleep before you can get up and face a new day.

The Sure-Alarm™ Battery Back Up System not only maintains the time and alarm settings in case of a power failure, but it will also wake you up even if the power is 'Off' at the selected alarm time, as long as the back up battery has sufficient power. Please read this instruction manual completely to make sure that you understand all of the features of your new clock radio, and please save this manual for future reference. If you experience any problems with the set up or operation of this radio, please call the Emerson Radio Corporation Customer Service Hotline, toll free at: 1-800-898-9020.

The serial number of your radio is located on a label on the bottom of the cabinet. We suggest that you record the serial number in the space below for future reference.



Model No: GP808

Serial Number: _____



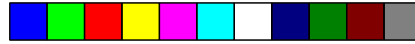

IMPORTANT NOTES

- Avoid installing this unit in places exposed to direct sunlight or close to heat radiating appliances such as electric heaters, on top of other stereo equipment that radiates too much heat, places lacking ventilation or dusty areas, places subject to constant vibration and/or humid or moist areas.
- Operate controls and switches as described in the manual.
- Before turning on the power, make certain that the power cord is properly installed.
- When moving the clock, be sure to first disconnect the power cord and remove cords connected to other equipment.
- Do not attempt to clean this unit with chemical solvents as this might damage the finish. Use a clean dry cloth.

FCC INFORMATION

This equipment has been tested and found to comply with the limits for a Class B digital device, pursuant to Part 15 of the FCC Rules. These limits are designed to provide reasonable protection against harmful interference in a residential installation. This equipment generates, uses, and can radiate radio frequency energy and, if not installed and used in accordance with the instructions, may cause harmful interference to radio communications. However, there is no guarantee that interference will not occur in a particular installation. If this equipment does cause harmful interference to radio or television reception, which can be determined by turning the equipment off and on, the user is encouraged to try to correct the interference by one or more of the following measures:

- Re-orient or re-locate the receiving antenna.
- Increase the separation between the equipment and receiver.
- Connect the equipment into an outlet on a circuit different from that to which the receiver is connected.
- Consult the dealer or an experienced radio/TV technician for help.

This device complies with Part 15 of the FCC Rules. Operation is subject to the following two conditions:

- (1) This device may not cause harmful interference, and
- (2) This device must accept any interference received, including interference that may cause undesired operation.

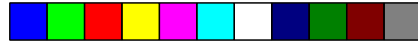

PREPARATION FOR USE

UNPACKING AND SET UP

- Remove all packing materials from the unit. Also remove any descriptive labels from the front or top of the radio. Do not remove any labels from the back or bottom of the radio.
- Place the radio on a stable shelf, desk, nightstand, table, etc, convenient to a 120V 60Hz AC outlet, and away from direct sunlight or sources of heat, humidity, moisture, dust, or vibration.
- Unwind the AC power cord. The FM antenna is built into the power cord so be sure to extend it to its full length for best FM reception.

BACK UP BATTERY INSTALLATION

The Back Up battery compartment is located on the bottom of the radio. Open the battery door, as shown in the illustration, and connect a 9V battery (not included) to the battery terminals. The battery can only be connected one way. Push the battery back into the battery compartment and replace the battery door.

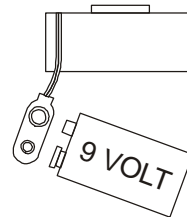
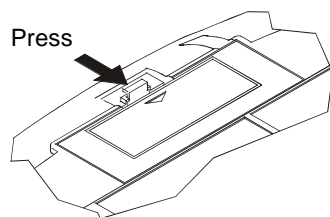

Note: Use only a well known brand of Alkaline battery for longest life and best performance.

In the event of a temporary power interruption the clock display will go off, but the back up battery will maintain the time and alarm settings. When power is restored the clock display will come on again and the time and alarm settings will be correct.

POWER FAILURE INDICATION

If you do not install a battery, or if the battery is exhausted and the power is interrupted, the time and alarm settings will be lost. When power is restored the display will begin flashing. This flashing display is your indication that the clock is incorrect and you must reset both the time and alarm settings.

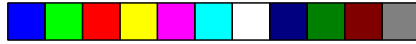

POWER SOURCE

This radio is designed to operate on normal 120V 60Hz AC house current only. Operating the radio with any other power supply may cause damage to the unit which is not covered by your warranty.

Fully extend the AC power cord and insert the plug into a polarized AC120V 60Hz outlet. Note that this unit has a polarized AC plug with one wide blade and one narrow blade. This is a safety feature designed to protect you from electric shock. If this plug will not fit into your outlet you may have an outdated, non-polarized outlet. Do not try to defeat this safety feature by using an adapter, or filing the wider blade on the plug to make it fit into your outlet. Contact a licensed electrician to replace your outdated outlet.

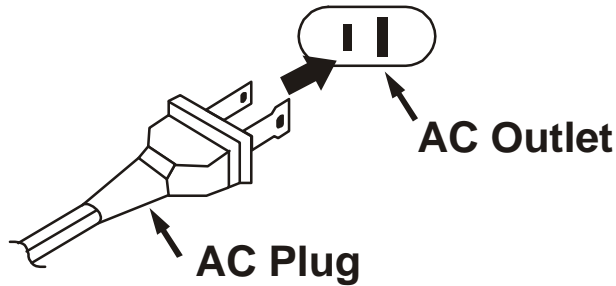

Note: Be sure to connect this radio to an outlet that is always 'live'. Do not connect this unit to an outlet that is controlled by a wall switch.

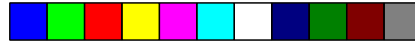

OPERATING INSTRUCTIONS

SETTING THE CLOCK

When the unit is plugged in for the first time the clock will show (AM) "12:00" and the display will flash. The flashing will stop after the clock has been set.

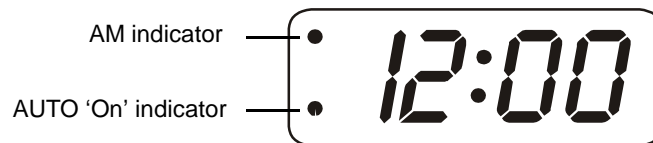

- 1.) Depress the CLOCK button and the HOUR button together to adjust the clock to the correct hour, then release the buttons.

Note: Be sure to set the hour correctly for AM or PM. If the AM Indicator is On', the time displayed is AM. If the AM indicator is 'Off', the time displayed is PM.

- 2.) Depress the CLOCK button and the MINUTE button together to adjust the clock to the correct minute, then release the buttons.

SETTING THE WAKE UP TIME

- 1.) Depress the ALARM button and the HOUR button together to adjust the clock display to the correct wake-up hour, then release the buttons. Be sure to set the wake-up hour correctly for either AM or PM.
- 2.) Depress the ALARM button and the MINUTE button together to adjust the clock display to the correct wake-up minute, then release the buttons.

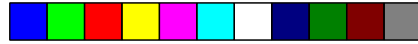

LISTENING TO RADIO

- 1.) Set the BAND switch to the desired band, AM or FM.
- 2.) Set the VOLUME control to a low setting.
- 3.) Slide the Power switch to the 'ON' position.
- 4.) Use the TUNING control to select the desired station.
- 5.) Adjust the VOLUME control to a comfortable level.
- 6.) When you are finished listening, slide the Power switch to the 'OFF' position.

Hints For Better Reception

FM

The FM antenna is inside the power cord. Make sure the power cord is fully extended for best reception.

AM

The AM antenna is inside the radio cabinet. If AM reception is unsatisfactory, try rotating or repositioning the cabinet until you find the position that provides the best reception for that particular station.

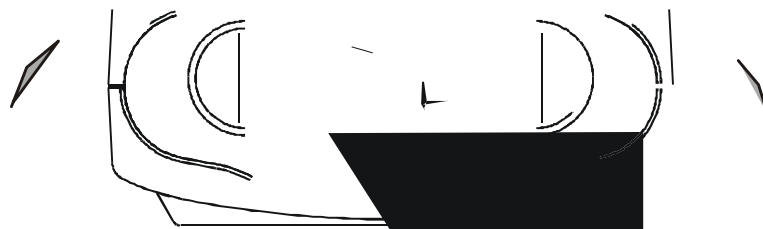



WAKE TO RADIO

- 1.) Depress the ALARM/RESET button. The display will change from the correct time to wake up time. Adjust the wake up time as described on page 7, if necessary.
- 2.) Slide the Power switch to the 'ON' position and select the station and the volume level that you want to hear when you wake up.
- 3.) Slide the Power switch to the 'AUTO' position. The radio will turn off and the AUTO indicator comes on.
- 4.) At the selected wake up time the radio will turn 'On' automatically. It will play for 1 hour and 59 minutes and then shut off automatically and reset itself for the following day.
- 5.) To stop the radio sooner press the ALARM/RESET button. The radio stops immediately and the alarm resets itself for the following day. To cancel the alarm completely slide the Power switch to the 'OFF' position. The AUTO indicator goes off.

WAKE TO BUZZER ALARM

- 1.) Depress the ALARM button. The display will change from the correct time to wake up time. Adjust the wake up time as described on page 7, if necessary.
- 2.) Slide the Power switch to the 'BUZZ' position. The AUTO indicator comes on.
- 3.) At the selected wake up time an electronic buzzer alarm will turn 'On' automatically. It will continue for 1 hour and 59 minutes and then shut off automatically and reset itself for the following day.
- 4.) To stop the buzzer alarm sooner, press the ALARM/RESET button. The buzzer stops immediately and the alarm resets itself for the following day. To cancel the alarm completely slide the Power switch to the 'OFF' position. The AUTO indicator goes off.



SNOOZE (REPEAT ALARM)

If you need a few extra minutes sleep when the alarm comes on in the morning, press the SNOOZE button. The alarm will stop for approximately 9 minutes, and then turn on again. This operation can be repeated several times if necessary.

SLEEP TO MUSIC TIMER

The sleep to music timer allows you to fall asleep to music for up to 1 hour and 59 minutes, and then shuts the radio off automatically.

The sleep timer can be activated when the Power switch is set to the 'OFF', 'AUTO', or 'BUZZ' positions.

- 1.) Depress the SLEEP button to start the sleep timer. The display indicates "0:59" and the radio turns 'On'.
- 2.) To adjust the amount of sleep timer operation, continue to hold the SLEEP button and depress the MINUTE button. The display starts counting down from 59 minutes. Release the MINUTE button when the display shows the desired minute. To add 1 hour, continue to hold the SLEEP button and press the HOUR button once.
- 3.) When the desired amount of sleep time appears on the display, release all the buttons. The radio will continue to play until the sleep timer counts down to "0:00", and then the radio shuts off automatically.
- 4.) To shut off the radio and cancel the sleep timer before it counts down to "0:00", press the SNOOZE button. The radio stops immediately.

IMPORTANT:

Remember that the station and volume setting that you select for sleep timer operation are the same settings you will hear the following morning if you have the alarm set for 'WAKE TO RADIO'.



NIGHT LIGHT

Slide the NIGHT LIGHT switch to either the 'LO' or 'HI' position to turn on the nightlight. Slide to the 'OFF' position to turn the nightlight off.

BULB REPLACEMENT

To change the bulb use a coin to turn the bulb holder clockwise slightly until it pops up from the bottom cabinet. Remove the bulb holder and discard the old bulb. Place the new bulb in the bulb holder and insert the bulb holder into the cabinet. Turn counterclockwise slightly to lock it in place. See following illustration.

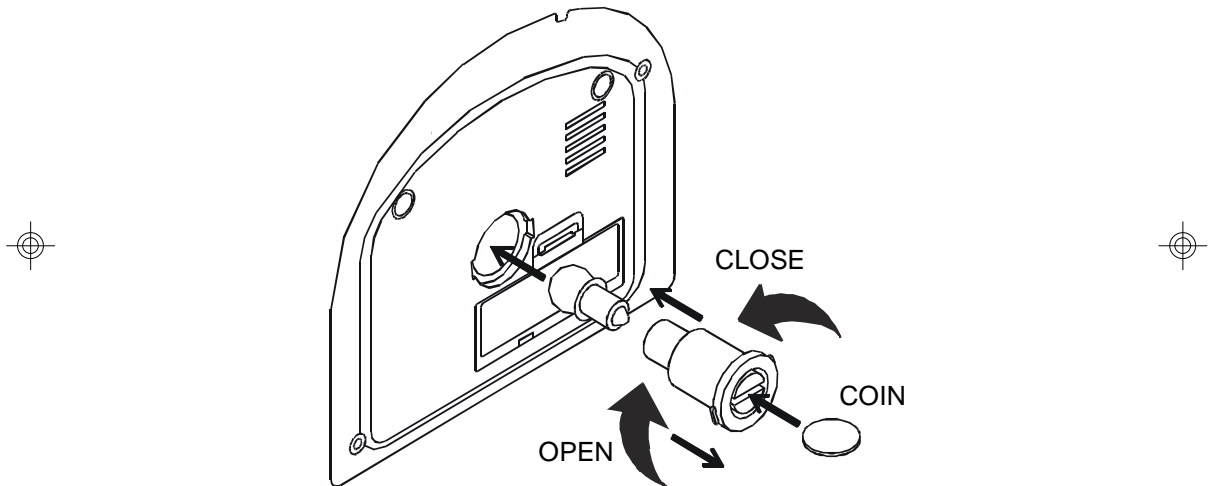

Replacement Bulb Information:

Type No: PR12

Rating: DC6V, 0.5A.

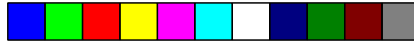

CARE AND MAINTENANCE

There are no user serviceable parts inside this radio. Please refer all service problems to a qualified service facility. See the warranty page of this manual for further details.

If the cabinet becomes dusty, wipe the exterior with a soft dust cloth only. Never use dusting sprays or polishes on the cabinet.

If the cabinet becomes dirty or smudged with fingerprints it may be wiped with a soft cloth that has been slightly dampened with a mild soap and water solution. Always disconnect the power cord from the AC outlet before cleaning, and never allow any liquid to get inside the cabinet.

Note: If there is no battery in the back-up battery compartment, the Time and Alarm settings will be lost when the power cord is disconnected for cleaning. Reset the clock and wake up times after reconnecting the power cord.



	TO FIND THE LOCATION AND PHONE NUMBER OF YOUR NEAREST SERVICE CENTER PERMITTED TO PERFORM WARRANTY...
CALL TOLL FREE: 1-800-695-0098	
FOR ADDITIONAL SET-UP OR OPERATING ASSISTANCE PLEASE CALL: 1-800-898-9020	
FOR CUSTOMER SERVICE, PLEASE WRITE TO: Emerson Radio Corp. Consumer Affairs Dept. 1901 Diplomat Drive, Farmers Branch, TX 75234.	



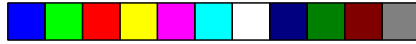

LIMITED WARRANTY

Emerson Radio Corp. warrants manufacturing defects in original material, including original parts and workmanship, under normal use and conditions, for a period of ninety (90) days from the date of original purchase in the U.S. With your dated proof of purchase, we will provide repair service at no charge for labor and parts (excluding bulbs) at an authorized Depot Repair Facility, or replace the product in our discretion. For repair or replacement, pack your unit in a padded box, enclose your check or money order payable to Emerson Radio Corp. in the amount of \$5.00 (not required by California residents) to cover shipping and handling costs, and enclose a copy of your proof of purchase. Send your unit to:

Emerson Radio Corp.

1901 Diplomat Drive.

Farmers Branch, TX 75234.

This warranty does not cover damage from negligence, misuse, abuse, accident, failure to follow operating instructions, commercial use, rental, repairs by an unauthorized facility, or products purchased, used, serviced or damaged outside of the United States.

THIS WARRANTY GIVES YOU SPECIFIC LEGAL RIGHTS, AND YOU MAY ALSO HAVE OTHER RIGHTS WHICH VARY FROM STATE TO STATE.

AU898I



girlpower™

BY

 **Emerson®**

EMERSON
Part No. : 21-2032
207-01

Printed in China