

Strength SERIES Trainer

ST-OBA

OLYMPIC BENCH WITH ARM AND LEG ATTACHMENT

OWNERS MANUAL

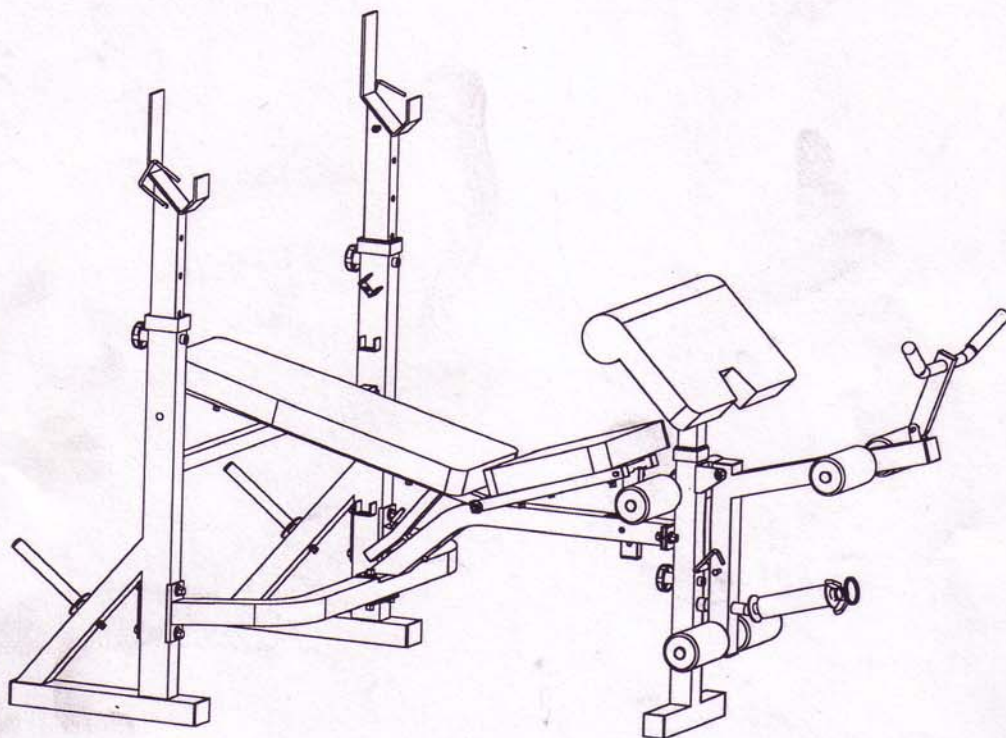

INCLUDES:

SAFETY NOTICE
HARDWARE IDENTIFIER
ASSEMBLY INSTRUCTIONS
EXPLODED DRAWING
PARTS LIST
WARRANTY
ORDERING PARTS



keysfitness.com



Please read all instructions carefully before using this product

SAFETY TIPS

Consult with your physician before engaging in any vigorous exercise. Know your heart rate and/or pulse as well as your physician-recommended heart rate training zone. Proper medical clearance is recommended for anyone beginning an exercise program especially if you are 35 years of age or older or suffer from heart respiratory problems.

- Warm-up before any exercise program with 8 minutes of aerobic-like activity followed by stretching from head to toe.
- Wear comfortable clothes that allow freedom of movement and are not tight or restricting.
- Wear comfortable shoes made with good support and non-slip soles.
- Breathe naturally, never holding your breath during an exercise.
- Perform exercises consistently with proper technique and pass through a full range of motion.
- Increase resistance by adding heavier weights. Decrease resistance by using lighter weights.
- Always use a spotter for safety.
- Avoid over-training. You should be able to carry on a conversation while exercising.
- After an exercise session. Cool down with slow stretching, cycling or walking.

EXERCISE DEFINITIONS

Sets: A set is one complete routine of exercises. Complete 1-3 sets for each exercise.

Repetitions: (referred to as reps) are the number of times you perform an exercise in a row. We recommend beginning with 6 reps and increasing up to 12 reps as indicated below.

Novice: start with one set of 8-12 reps. Once you can complete the entire set of 12 reps consecutively, progress to the intermediate level.

Intermediate: complete 2 sets of 8-12 reps once you can complete two sets of 12 reps consecutively. Progress to the advanced level.

Advanced: complete 3 sets of 12 reps

DISCLAIMER:

Keys Fitness Products is not responsible for the misuse of any Keys Fitness Products nor for any injury sustained while using any Keys Fitness Products. The consumer uses any or all of Keys Fitness Products at their own risk.

BEFORE YOU BEGIN

Before you begin assembly of your keys fitness product, please take a moment to review the hardware and parts list on the following pages. Each part has been illustrated and numbered for easy identification. Check this list against the contents of your package to make sure you have all required parts. If any parts are missing, please do not return this product to the store. Contact our service department immediately at 1-888-340-0482 and we will rush you any parts you may require.

TOOLS REQUIRED

You will need two adjustable wrenches for assembly

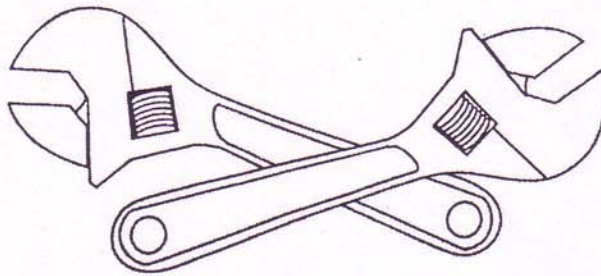

HARDWARE IDENTIFIER

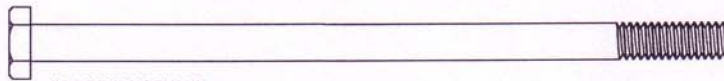

#A1-M10X195X1PC

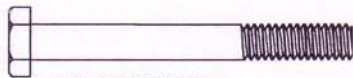

#A2-M10X90X4PCS

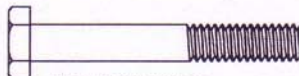

#A3-M10X75X3PCS

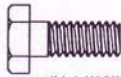

#A4-M10X25X2PCS

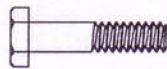

#A5-M8X40X8PCS



#A6-M8X20X4PCS



#B1-20PCS (10/20mm)



#B2-12PCS (8/16mm)



#C1-10PCS (M10)



#C2-3PCS (M8)

HARDWARE IDENTIFIER



#36-1PC



#31-1PC



#4-2PCS

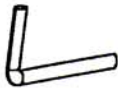

#19-1PC



#15-1PC



#33-1PC

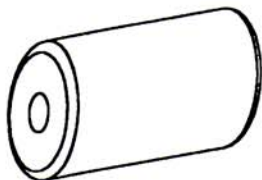

#30-6PCS

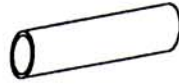

#40-2PCS

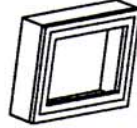

#3-2PCS



#29-1PC



#32-1PC



#38-1PC



#13-8PCS



#1-1PC



#43-1PC



#9-4PCS



#41-2PCS



#20-5PCS



#42-2PCS



#22-9PCS



#6-9PCS

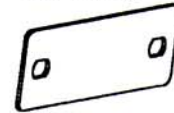

#8-2PCS

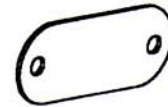

#17-1PC

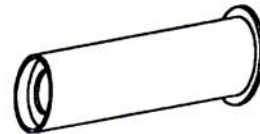

#35-1PC

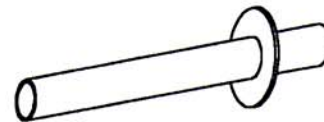

#7-2PCS

HARDWARE IDENTIFIER

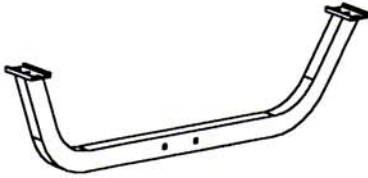

#10-1PC



#23-1PC



#12-1PC



#14-2PCS

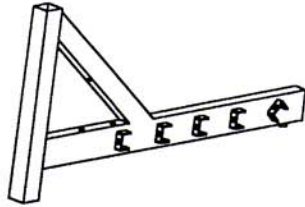

#11-1PC



#16-1PC

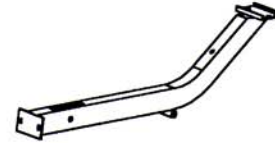

#18-1PC

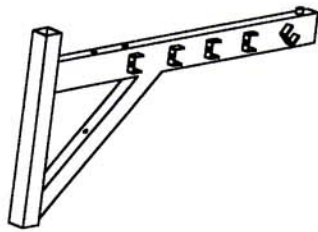

#5-1PC



#24-2PCS

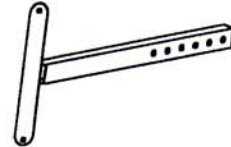

#28-1PC



#34-3PCS

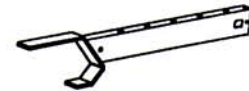

#2-2PCS

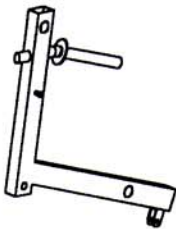

#37-1PC

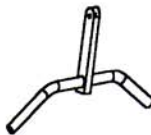

#39-1PC



#21-1PC

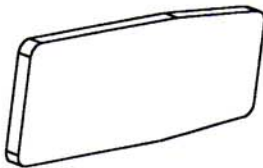

#26-1PC

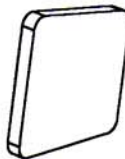

#25-1PC

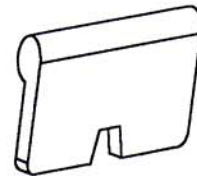

#27-1PC

ASSEMBLY INSTRUCTIONS

STEP #2

- A) Attach the front base (#21) to the mainframe (#18) with two bolt M10X25(#A4), four washers 10 (#B1) and two nylon nuts M10 (#C1)
- B) Attach the mainframe/front base assembly to the center of the cross bar (#10) using two bolts M10x75 (#A3), four washers 10 (#B1) and two nylon nuts M10 (#C1). Install the oval reinforcement plate on the underside of the cross bar during this assembly.
- C) Attach the backrest tubes (#14) and seat tubes (#24) to the mainframe. Push the backrest fixed bar (#16) into the hole of the backrest tubes as illustrated. Set the seat adjustment bracket (#23) down into the hole on top of the mainframe so that the welded tube is at the top and resting across the mainframe. Push the seat adjustment bracket through the hole near the front of one seat tube as illustrated.
- D) Push a bolt M8x195 (#A1) with a washer 10 (#B1) through the hole nearest the end of one of the shorter seat tubes. Push the bolt all the way through the seat tube, and then into the single side hole of one of the longer backrest tubes. Push the bolt through the backrest tube and then through the small welded tube across the top of the mainframe. Continue to push the bolt through the side hole of the other backrest tube, through the hole nearest the end of the other seat tube, then out the other side. Secure with one washer 10 (#B1) and one nylon nut M10 (#C1).
- E) Attach the backrest pad (#26) to the backrest tubes using four bolts M8x40 (#A5) and four washers 10 (#B2). The backrest pad can be put into an upright, military position by pushing the long lock pin (#15) through the hole in the mainframe and resting the bottom of the backrest tubes against the back of the pin
- F) Attach the seat pad (#25) with the wider end to the rear, to the top of the seat tubes using four bolts M8X40 (#A5) and four washers 10 (#B2). The position of the seat pad can be adjusted by raising or lowering the front edge. Push the short lock pin (#19) through one of the holes in the seat adjustment bracket and let it rest on top of the mainframe.

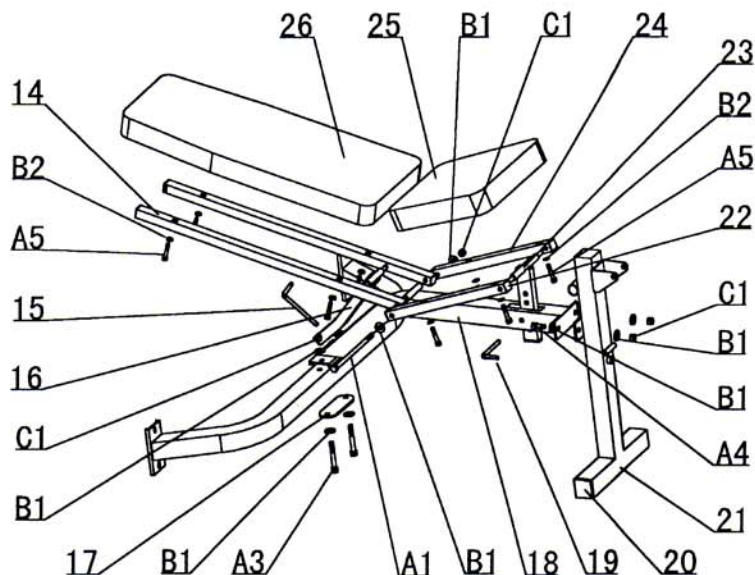

STEP #3

- A) Attach the leg developer (#37) between the brackets on the front of the front base with one bolt M10X75 (#A3), two washers 10 (#B1) and a nylon M10(#C1) nut.
- B) Push a roller tube (#34) through the upper and lower holes in the leg developer and through the tube welded to the back of the front base. Push a foam roll onto each side of each tube.
- C) Attach the arm curl handle (#39) between the brackets on the top front of the leg developer with the ring head lock pin (#38). The attached arm curl pad (#27) on the arm curl handle should face down. If you are using Olympic weights, slide the Olympic adapter (#35) onto the leg developer weight holder and secure with the spring collar (#36).
- D) Push the threaded end of the leg developer safety hook (#33) through the small welded tube across the front of the front base secure with one small nylon nut M8 (#C2).
- E) Attach the arm curl pad to the arm curl post (#28) with two bolts M8x20 (#A6) and two washers 8 (#B2). Push the arm curl post down into the top of the front base, adjust and secure with one small knot bolt M12x60mm (#31) installed from behind the front base.

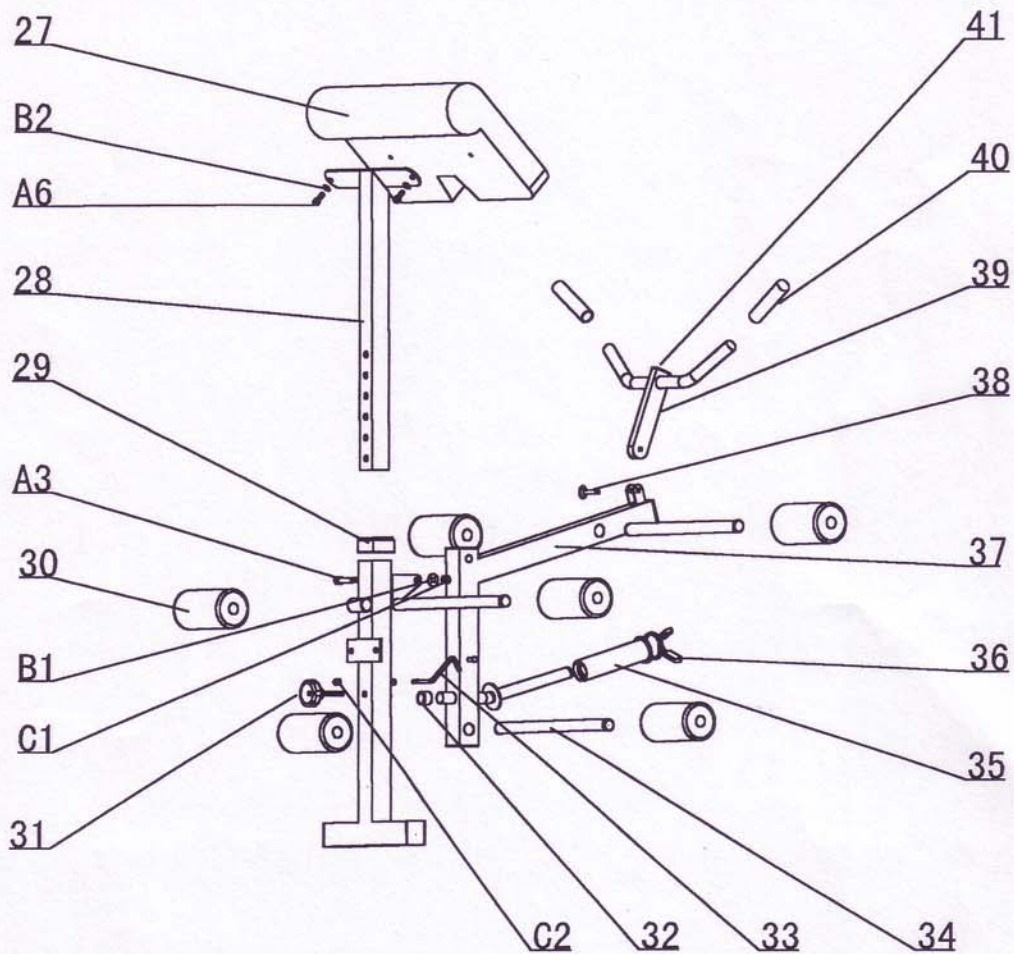

ST-OBA EXPLODED VIEW

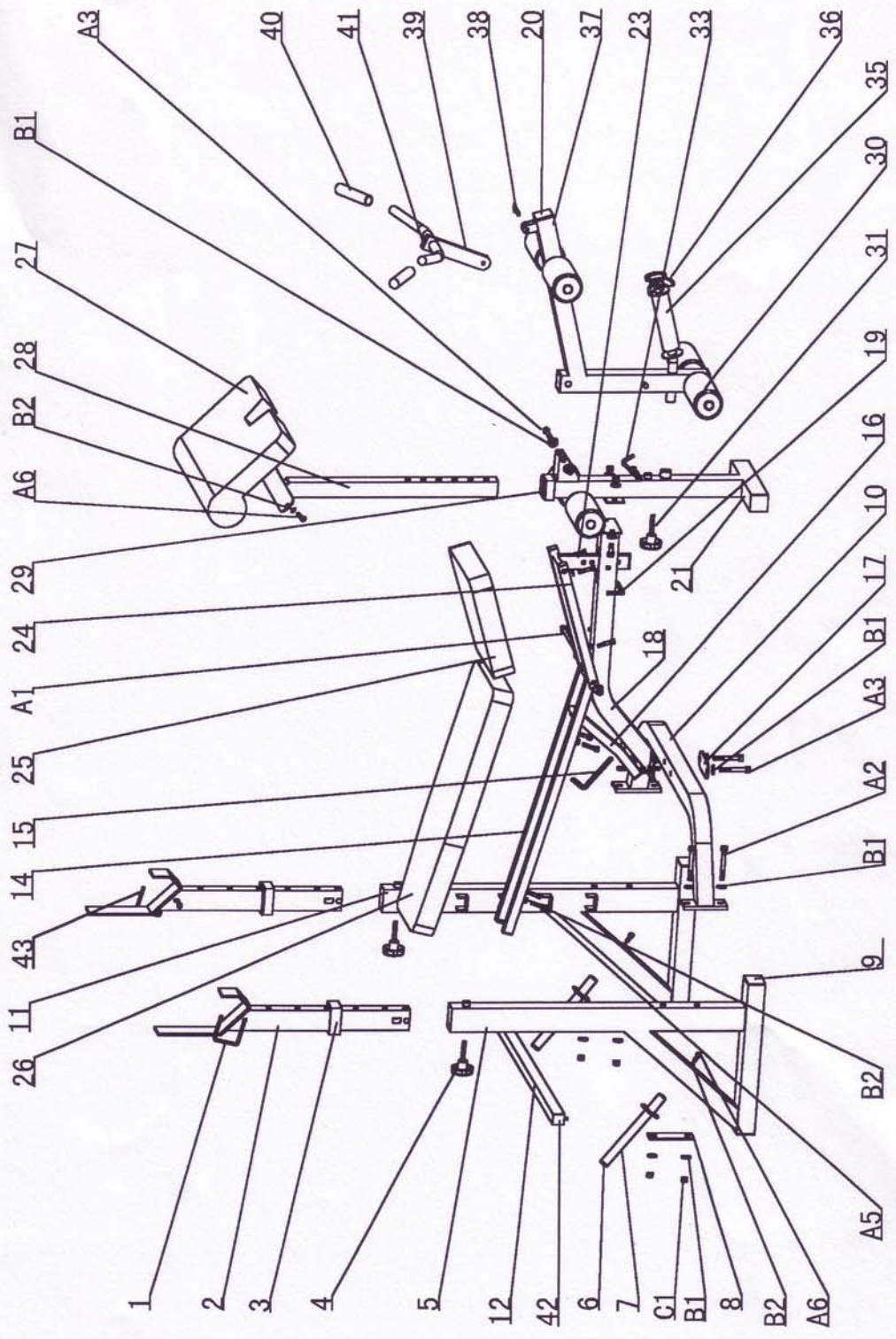



ST-OBA PARTS LIST

Part#	Description	Qty	Part#	Description	Qty
1	Left Safety Hook	1	30	Roller Foam	6
2	Crutch	2	31	Knob Bolt M12x60	1
3	Rect. Out Plug 50x70mm	2	32	Round Cap	1
4	Knob bolt M12x80	2	33	Leg Developer Safety Hook	1
5	Left Upright	1	34	Roller Foam Tube	3
6	Round Inner Plug	9	35	Olympic Adaptor	1
7	Weight Storage	2	36	Spring Collar 1"	1
8	Rectangular Plate	2	37	Leg Developer	1
9	Sq. Inner Plug 50x70mm	4	38	Ring Head Lock pin	1
10	Cross Bar	1	39	Arm Curl Handle	1
11	Right Upright	1	40	Handle Grip	2
12	Backrest Adj Bar	1	41	Sq. Inner Plug 20x40mm	2
13	Small Rubber Plug	8	42	Sq. Inner Plug 32mm	2
14	Backrest Tube	2	43	Right Safety Hook	1
15	Long Lock Pin	1	A1	Bolt M10X195	1
16	Backrest Fixed Bar	1	A2	Bolt M10X90	4
17	Oval Reinforcement Plate	1	A3	Bolt M10X75	3
18	Main Frame	1	A4	Bolt M10X25	2
19	Short Lock Pin	1	A5	Bolt M8X40	8
20	Sq. Inner Plug 50mm	5	A6	Bolt M8X20	4
21	Front Base	1	B1	Washer 10/20	20
22	Sq. Inner Plug 25mm	9	B2	Washer 8/16	12
23	Seat Adj Bracket	1	C1	Nylon Nut M10	10
24	Seat Tube	2	C2	Nylon Nut M8	3
25	Seat Pad	1			
26	Backrest Pad	1			
27	Arm Curl Pad	1			
28	Arm Curl post	1			
29	Rect. Outer Plug 50mm	1			



WARRANTY

Keys Fitness Products LP warrants this product for a period of 90 days on parts and lifetime on the frame from the original date of purchase. This warranty covers the product from defects in materials and workmanship for the original purchaser. Using this product for commercial purposes, products damaged by misuse, abuse, or from shipping, moving and storage will void this warranty.

Replacement parts are available from Keys Fitness Products LP. To contact us for customer service or replacement parts, call 1(888)340-0482.

CUSTOMER SERVICE

If you have any questions regarding this or any Keys Fitness product, or if we may be of assistance in any way, please do not hesitate to call our toll free number 1(888)340-0482.

Remember, before using any exercise product, consult a physician.

Keys Fitness Products, LP

4009 Distribution Drive, Suite 250

Garland, Texas 75041

keysfitness  com