



Emerson[®]

***AM/FM STEREO CLOCK RADIO
with COMPACT DISC PLAYER
POWER PANEL LOADING SYSTEM
and REMOTE CONTROL
(Model CKD2330 only)***

OWNER'S MANUAL

CKD2328 (Without Remote Control)

CKD2330 (With Remote Control)

Visit our web site at www.emersonradio.com



CAUTION

TO PREVENT FIRE OR SHOCK HAZARD, DO NOT USE THIS PLUG WITH AN EXTENSION CORD, RECEPTACLE OR OTHER OUTLET UNLESS THE BLADES CAN BE FULLY INSERTED TO PREVENT BLADE EXPOSURE. TO PREVENT FIRE OR SHOCK HAZARD, DO NOT EXPOSE THIS APPLIANCE TO RAIN OR MOISTURE.



The lightning flash with arrow-head symbol, within an equilateral triangle is intended to alert the user to the presence of uninsulated 'dangerous voltage' within the product's enclosure that may be of sufficient magnitude to constitute a risk of electric shock to persons.

CAUTION

RISK OF ELECTRIC SHOCK
DO NOT OPEN

WARNING: TO REDUCE THE RISK OF ELECTRIC SHOCK DO NOT REMOVE COVER (OR BACK), NO USER SERVICEABLE PARTS INSIDE REFER SERVICING TO QUALIFIED SERVICE PERSONNEL.



The exclamation point within an equilateral triangle is intended to alert the user to the presence of important operating and maintenance (servicing) instructions in the literature accompanying the appliance.

IMPORTANT SAFETY INSTRUCTIONS

- 1.) Read these instructions.
- 2.) Keep these instructions.
- 3.) Heed all warnings.
- 4.) Follow all instructions.
- 5.) Do not use this apparatus near water.
- 6.) Clean only with dry cloth.
- 7.) Do not block any ventilation openings. Install in accordance with the manufacturer's instructions.
- 8.) Do not install near any heat sources such as radiators, heat registers, stoves, or other apparatus (including amplifiers) that produce heat.
- 9.) Do not defeat the safety purpose of the polarized or grounding-type plug. A polarized plug has two blades with one wider than the other. A grounding type plug has two blades and a third grounding prong. The wide blade or the third prong are provided for your safety. If the provided plug does not fit into your outlet, consult an electrician for replacement of the obsolete outlet.
- 10.) Protect the power cord from being walked on or pinched particularly at plugs, convenience receptacles, and the point where they exit from the apparatus.
- 11.) Only use attachments / accessories specified by the manufacturer.
- 12.) Unplug this apparatus during lightning storms or when unused for long periods of time.
- 13.) Refer all servicing to qualified service personnel. Servicing is required when the apparatus has been damaged in any way, such as power-supply cord or plug is damaged, liquid has been spilled or objects have fallen into the apparatus, the apparatus has been exposed to rain or moisture, does not operate normally, or has been dropped.
- 14.) This appliance shall not be exposed to dripping or splashing water and no object filled with liquids such as vases shall be placed on the apparatus.
- 15.) Do not overload wall outlet. Use only power source as indicated.
- 16.) Use replacement parts as specified by the manufacturer.
- 17.) The product may be mounted to a wall only if recommended by the manufacturer.
- 18.) Upon completion of any service or repairs to this product, ask the service technician to perform safety checks.



Thank you.....

for purchasing this Emerson stereo clock radio with CD player and Power Panel CD loading system. The motorized front panel rotates 90 degrees at the touch of a button to make loading and unloading your CDs simple and easy. The Power Panel loading system also means that this radio takes up less space on the bedside table than other radios with drawer type CD loading systems.

In addition to the excellent sound from both the radio and the CD player this unit also features a digital radio frequency display to make tuning your favorite stations easier. There's an automatic display dimmer that adjusts the brightness of the clock and radio display to match the room lighting conditions. And there's a two-way snooze control to make it easier to grab those few extra minutes of sleep. You can press the snooze button as usual or, if that's too much of a task while you're half-asleep, you can just wave your hand in front of the radio to activate the snooze function.

Of course there's a battery back up system to maintain your clock and alarm settings in the event of a power interruption. And on model CKD2330 we've even included a credit card size, 10-button remote control so you can switch the unit On and Off, operate the CD functions, and adjust the volume from across the room.

This system was designed to give you many years of enjoyment with an absolute minimum of care and maintenance. Please read this Owners Manual carefully and completely to ensure that you get the maximum benefit from all the outstanding features we have included in this product. If you encounter any problem with the set up or operation of this model please do not return it to the retail store. Please call the Emerson Customer Service Hotline toll free at 1-800-898-9020. One of our service technicians will try to diagnose the problem for you.

Once again thanks for choosing this Emerson audio product.

For future reference, record the serial number in the space provided.

Model No: CKD2328/CKD2330

Serial No: _____



IMPORTANT NOTES

- Avoid installing this unit in places exposed to direct sunlight or close to heat radiating appliances such as electric heaters, on top of other stereo equipment that radiates too much heat, places lacking ventilation or dusty areas, places subject to constant vibration and/or humid or moist areas.
- Do not attempt to clean this unit with chemical solvents as this might damage the finish. Use a clean dry cloth.
- Operate controls and switches as described in the manual.
- Before turning 'On' the power, make certain that power cord is properly installed.
- Store your CDs in a cool area to avoid damage from heat.
- When moving the set, be sure to first disconnect the power cord.

CLASS 1 LASER PRODUCT

CLASS 1 LASER PRODUCT
APPAREIL À LASER DE CLASSE 1
PRODUCTO LASER DE CLASE 1

CAUTION
INVISIBLE LASER RADIATION
WHEN OPEN AND INTERLOCKS
DEFEATED.
AVOID EXPOSURE TO BEAM



This product contains a low power Laser Device.

FCC INFORMATION

This equipment has been tested and found to comply with the limits for a Class B digital device, pursuant to Part 15 of the FCC Rules. These limits are designed to provide reasonable protection against harmful interference in a residential installation. This equipment generates, uses, and can radiate radio frequency energy and, if not installed and used in accordance with the instructions, may cause harmful interference to radio communications. However, there is no guarantee that interference will not occur in a particular installation. If this equipment does cause harmful interference to radio or television reception, which can be determined by turning the equipment off and on, the user is encouraged to try to correct the interference by one or more of the following measures:

- Reorient or relocate the receiving antenna.
- Increase the separation between the equipment and receiver.
- Connect the equipment into an outlet on a circuit different from that to which the receiver is connected.
- Consult the dealer or an experienced radio/TV technician for help.

This device complies with Part 15 of the FCC Rules. Operation is subject to the following two conditions:

- (1) This device may not cause harmful interference, and
- (2) This device must accept any interference received, including interference that may cause undesired operation.

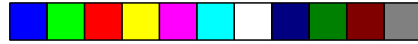

PREPARATION FOR USE

UNPACKING AND SETUP

- Carefully remove the main unit and the accessories from the display carton. Remove all the packing material from the unit and verify that you have the following items: Main unit, external AM antenna, and remote control (for model CKD2330 only).
- Carefully remove any small strips of tape that may have been used to prevent the Power Panel from moving in transit.
- Unwind the AC power cord and extend it to its full length.
- Unwind the lead wire FM antenna and extend it to its full length.
- This unit was shipped with a dummy CD transit card in the CD player. This dummy CD prevents the laser pick up from moving during shipment. This card must be removed before you can insert your own CDs. However in order to remove the card the unit must be connected to the AC outlet and the Power Panel must be opened electronically. Please refer to the instructions on page 18 of this manual.

TO AVOID DAMAGING YOUR UNIT DO NOT ATTEMPT TO MANUALLY OPEN THE POWER PANEL.

- Place the unit on a flat, level surface such as a table, desk, counter, shelf, etc, convenient to a 120V 60 Hz AC outlet, out of direct sunlight, and away from sources of excess heat, dust, moisture, or strong magnetic fields.



External AM Antenna

This unit utilizes an external AM loop antenna instead of a built in ferrite bar antenna.

- 1.) Insert the small white plug from the AM loop antenna into the AM antenna jack on the back of the radio. The plug can only be inserted one way.

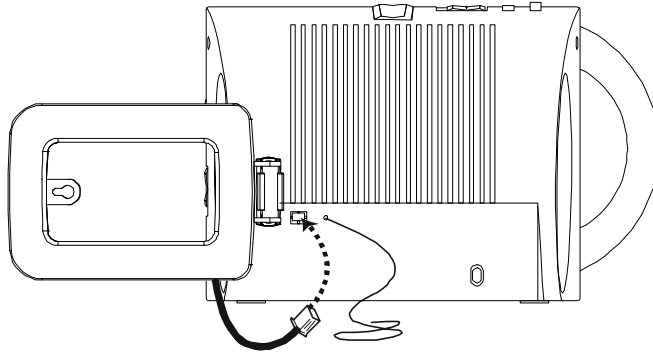

- 2.) Attach the AM loop antenna to the antenna bracket on the back of the radio as shown.

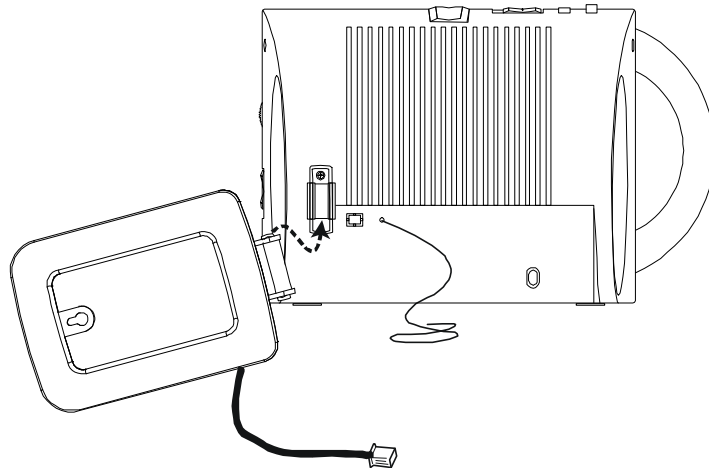



3.) Adjust the angle of the loop antenna until you find the position that provides the best AM reception.

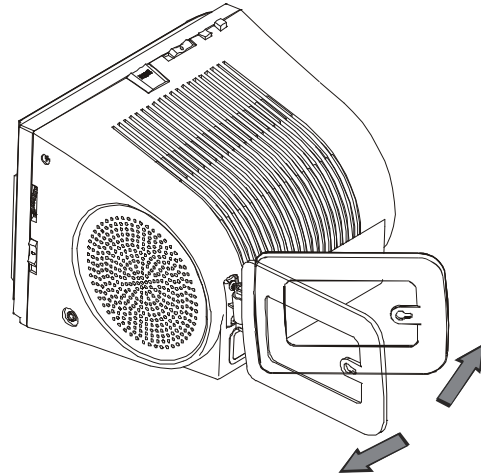

Note: If you find that AM reception is still unsatisfactory you can remove the loop antenna from the antenna mounting bracket and attach it to the wall with a thumbtack or small nail through the “keyhole” opening on the antenna frame.

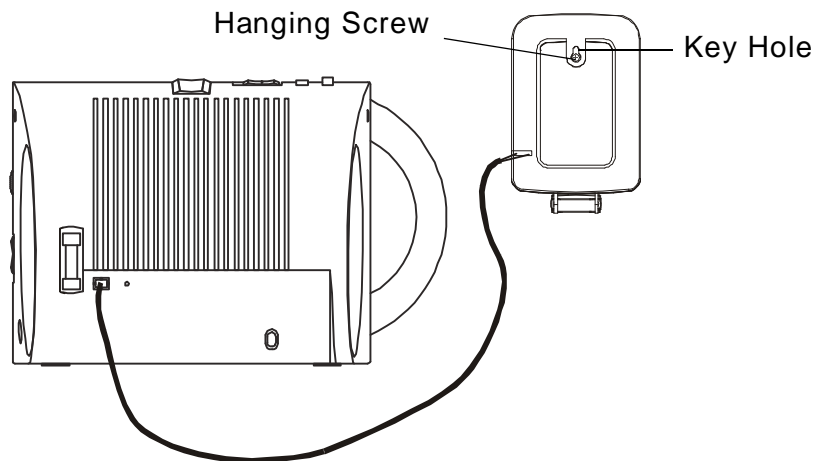



Battery Back Up System

This model includes a battery back up circuit that will maintain the clock and alarm settings in the event of a temporary power interruption. The battery back up system requires two “AA” batteries, not included. The battery compartment is located on the bottom of the cabinet.

- 1.) Turn the radio upside down. Slide the battery door in the direction of the arrow and remove the door.
- 2.) Insert two fresh “AA” alkaline batteries in the compartment. Be sure to observe the polarity markings engraved in the compartment. If the batteries are inserted incorrectly the back up system will not work.

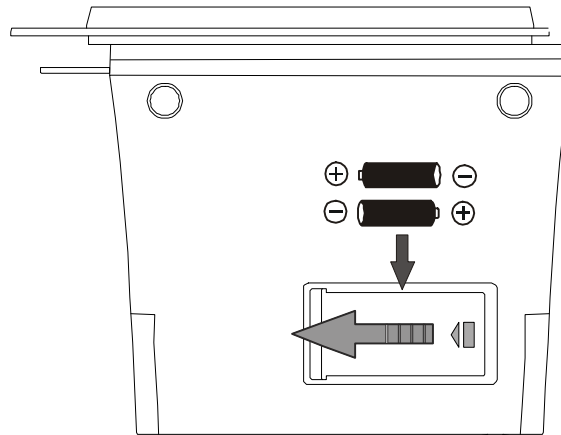

- 3.) Replace the battery door and turn the radio right side up.

If the power is interrupted the display will go off and the radio will not work. However the batteries will maintain the clock and alarm settings in memory. When the power is restored the display will come on again and the clock and alarm settings will be correct.

The life of the batteries will depend on the frequency and length of the power interruptions that you experience. For best results we suggest you install fresh batteries every 9 to 12 months. Always change both batteries together with a well-known brand of alkaline batteries. Do not mix old and new batteries, or different types of batteries such as alkaline and carbon-zinc batteries together.



Remote Control (Model CKD2330 Only)

Model CKD2330 includes a credit card size 10-button remote control that allows you to operate the CD player, control the volume, and switch the system 'On' and 'Off' from across the room. The remote control operates on one, button-style lithium battery (Type CR2032 or equivalent), included. We have placed a clear plastic spacer between the battery and the battery contact plate so that the battery will remain fresh until you are ready to use the remote. Pull on the end of the spacer tab to remove the spacer from the remote and activate the battery.

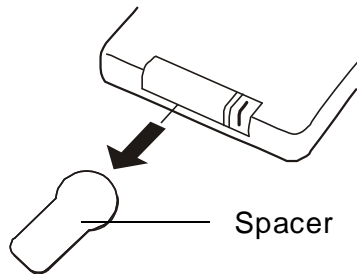

To use the remote control point the remote at the remote sensor on the front panel of the radio and press the appropriate buttons on the remote. The effective operating range of the remote is approximately 15 feet at an angle of no more than 15 degrees to the left or right of 'dead center'.

When the remote control no longer works or the operation becomes intermittent it is time to change the battery. Press downward on the locking tab and slide the battery holder out of the remote as shown.

Remove the exhausted CR2032 battery from the holder, insert a fresh battery into the holder with the "+" side facing up, and slide the holder back into the remote.

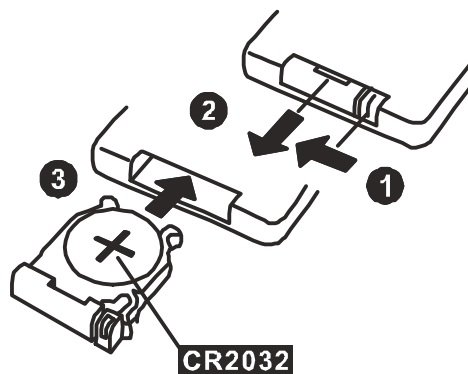



IMPORTANT BATTERY PRECAUTIONS:

- *Do not leave the exhausted battery lying around where a child or pet might play with or swallow it.*
- *If the battery is swallowed contact a physician immediately.*
- *Do not attempt to open the battery and do not dispose of the battery in a fire.*

PROTECT YOUR FURNITURE !!

This model is equipped with non-skid rubber 'feet' to prevent the product from moving when you operate the controls. These 'feet' are made from non-migrating rubber material specially formulated to avoid leaving any marks or stains on your furniture. However certain types of oil based furniture polishes, wood preservatives, or cleaning sprays may cause the rubber 'feet' to soften, and leave marks or a rubber residue on the furniture. To prevent any damage to your furniture we strongly recommend that you purchase small self-adhesive felt pads, available at hardware stores and home improvement centers everywhere, and apply these pads to the bottom of the rubber 'feet' before you place the product on fine wooden furniture.



POWER SOURCE

This radio is designed to operate on 120V 60Hz AC only. Attempting to operate this radio on any other power source could cause damage to the unit and such damage is not covered by your warranty.

Make sure the radio is connected to an AC outlet that is always “live”. Do not connect the radio to an outlet that is controlled by a wall switch.

NOTE: This unit has a polarized AC plug with one wide blade and one narrow blade. This plug will only fit into a matching polarized AC outlet. This is a safety feature to reduce the possibility of electric shock. If this plug will not fit in your AC outlet, you probably have an outdated non-polarized outlet. You should have your outdated outlet changed by a qualified, licensed electrician. Do not file the wide blade on the plug, or use an adapter to make the plug fit into your outlet. This defeats the safety feature and could expose you to electric shock.

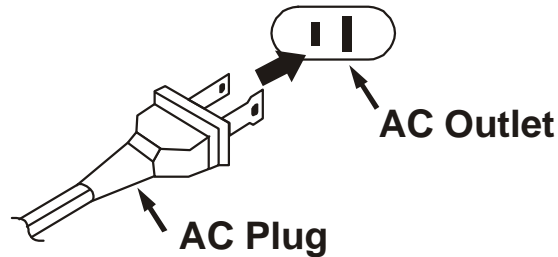

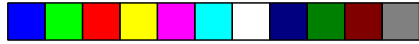

LOCATION OF CONTROLS AND INDICATORS

FRONT PANEL

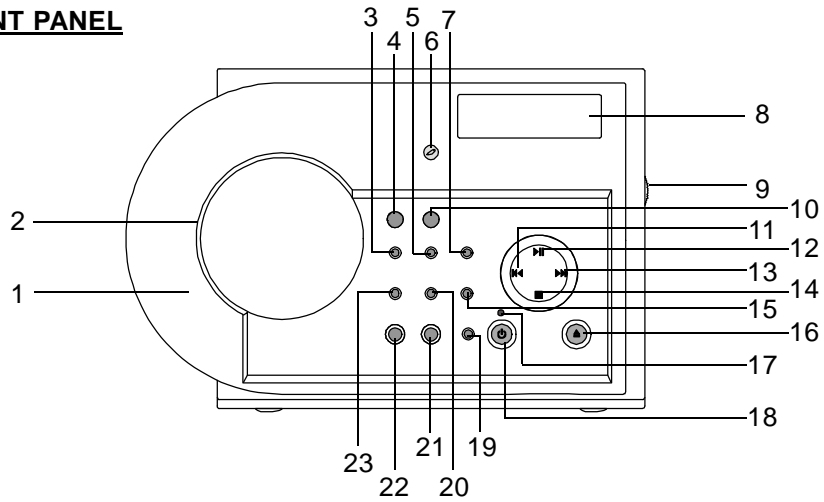



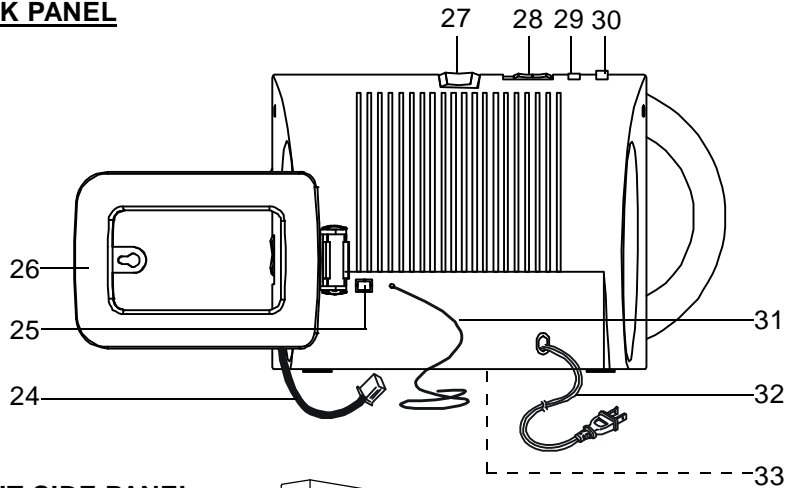



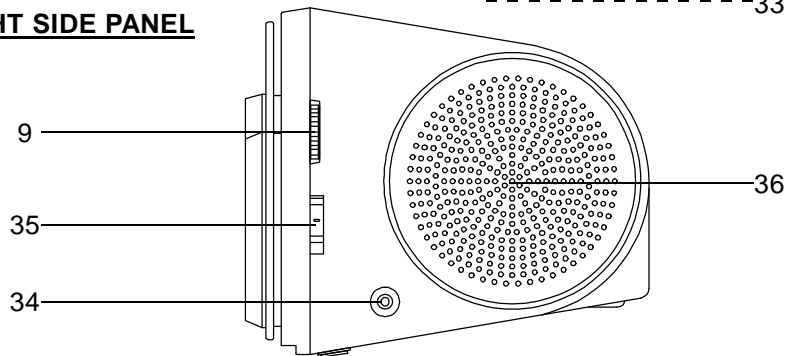

BACK PANEL



RIGHT SIDE PANEL





- 1.) CD Power Panel (Flashing Blue Light When Opening).
- 2.) Mute Indicator (Red).
- 3.) **ALARM SET** Button.
- 4.) Snooze Sensor.
- 5.) **CLOCK SET** Button.
- 6.) Display **AUTO DIMMER**.
- 7.) **PROGRAM** Button.
- 8.) LCD Display.
- 9.) **TUNING** Control.
- 10.) Remote Sensor.
- 11.) Reverse **SKIP/Search**  Button.
- 12.) **PLAY/PAUSE**  Button.
- 13.) Forward **SKIP/Search**  Button.
- 14.) **STOP**  Button.
- 15.) **REPEAT** Button.
- 16.) **OPEN/CLOSE**  Button.
- 17.) Standby LED Indicator.
- 18.) **STANDBY/ON**  Button.
- 19.) **SLEEP** Button.
- 20.) **MINUTE** Button.
- 21.) **VOL** (Volume) **UP/+** Button.
- 22.) **VOL** (Volume) **DOWN/-** Button.
- 23.) **HOUR** Button.
- 24.) AM Antenna Plug.
- 25.) AM Antenna Socket.
- 26.) AM Loop Antenna.
- 27.) **SNOOZE** Button.
- 28.) **CD/RADIO** Selector Switch.
- 29.) **ALARM ON/OFF** Button.
- 30.) **ALARM MUSIC**  /**BUZZER**  Switch.
- 31.) FM Wire Antenna.
- 32.) AC Power Cord.
- 33.) Backup Battery Compartment (Bottom Cabinet)
- 34.) Phones  Jack.
- 35.) **AM/FM/FM ST.** Selector Switch.
- 36.) Right Speaker.



REMOTE CONTROL (Model CKD2330 Only)

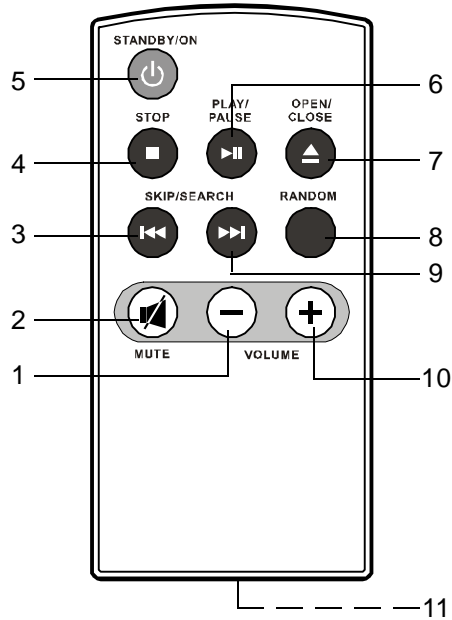

- 1.) **VOLUME –** Button.
- 2.) **MUTE** Button.
- 3.) Reverse **SKIP/SEARCH** **◀◀** Button.
- 4.) **STOP** **■** Button.
- 5.) **STANDBY/ON** **⏻** Button.
- 6.) **PLAY/PAUSE** **▶||** Button.
- 7.) **OPEN/CLOSE** **▲** Button.
- 8.) **RANDOM** Button.
- 9.) Forward **SKIP/SEARCH** **▶▶** Button.
- 10.) **VOLUME +** Button.
- 11.) Battery Compartment (Back Cabinet)



OPERATING INSTRUCTIONS

- **Make sure you have installed the back up batteries in the battery compartment.**
- **Make sure you have installed the AM loop antenna and extended the FM lead wire antenna to its full length.**
- **Make sure you have removed the remote control battery spacer from the remote handset (Model CKD2330 only).**
- **Connect the AC power cord plug to a 120V 60Hz AC outlet.**

SETTING THE CLOCK

When the radio is connected to the AC outlet for the first time the red Standby indicator will come on and the main display will light.

The display will show AM hour "12:00". Do not press the **STANBY/ON**  button. It is easier to set the clock while the unit is in the Standby mode (Standby indicator is 'On').



- 1.) Depress and hold the **CLOCK SET** button and repeatedly press the **HOUR** button to adjust the display to the correct hour, AM or **PM**.
- 2.) Continue to depress the **CLOCK SET** button and repeatedly press the **MINUTE** button to adjust the display to the correct minute.
- 3.) When the display shows the correct time release all the buttons.

The display will show the correct time whenever the unit is in the Standby mode (Standby indicator is 'On') or when the CD function is selected. To see the time when the Radio function is selected press the **CLOCK SET** button.



SETTING THE WAKE-UP TIME

- 1.) Depress and hold the **ALARM SET** button. The display will change from clock time to wake-up time and show "7:00 ". Repeatedly press the **HOUR** button to adjust the display to the correct wake-up hour, AM or **PM**.



- 2.) Continue to depress the **ALARM SET** button and repeatedly press the **MINUTE** button to adjust the display to the correct wake-up minute.
- 3.) When the display shows the desired wake-up time release all the buttons.



To check the wake-up time just press the **ALARM SET** button at any time. The display will show the wake-up time as long as the **ALARM SET** button is depressed.





LISTENING TO THE RADIO

- 1.) Slide the **CD/RADIO** selector switch, located on the top cabinet, to the **RADIO** position.
- 2.) Press the **STANDBY/ON**  button on the front panel or the remote control (model CKD2330 only) to turn the system 'On'. The Standby indicator goes off and an AM or FM radio frequency appears on the display.
- 3.) Select the desired band – **AM**, **FM**, or **FM ST.** – by sliding the Band selector, located on the right side, to the appropriate position.



- 4.) Tune to the desired station by slowly rotating the **TUNING** control on the right side. The digital frequency display will move up or down the band as you rotate the tuning control. If you tune to an FM Stereo station the **((ST))** indicator will appear in the display.

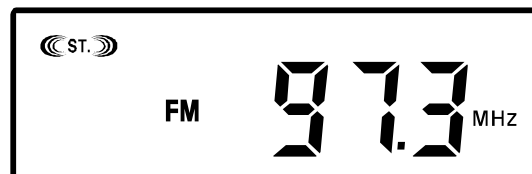

Note: This is a manual tuning radio with a digital frequency display. Slowly rotate the **TUNING** control until you find the best reception, even if the display does not indicate the exact frequency of the station.

- 5.) Press the **VOLUME +** or **-** buttons on the front panel or the remote control (model CKD2330 only) to adjust the volume to the desired level.
- 6.) When you are finished listening press the **STANDBY/ON**  button on the front panel or the remote control (model CKD2330 only) to return the system to the Standby (Power 'Off') mode. The Standby indicator comes 'on' again and the display changes from radio frequency to correct time.



Hints For Better Reception

FM – Adjust the position and direction of the FM lead wire antenna until you find the position and direction that provides the best reception.

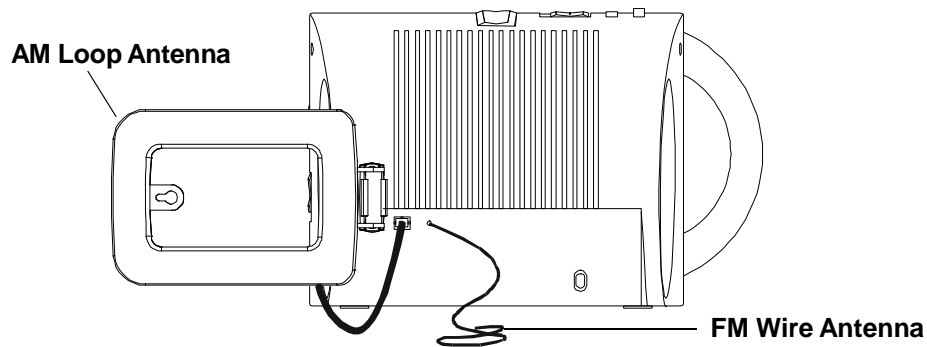

AM – Adjust the direction of the AM loop antenna that you connected to the back of the radio. If this does not provide sufficient improvement try removing the loop from the antenna bracket and moving it further away from the radio cabinet (as far as the wire will allow). You may also attach the loop to the wall with a thumbtack or small nail through the “keyhole” on the antenna frame.



PLAYING COMPACT DISCS

NOTE: Although this CD player can read CD-R and CD-RW discs, in addition to normal CDs, the playability of CD-R and CD-RW discs may be effected by the type of software that was used to create the discs, as well as the quality and condition of the blank media you are using. 100% playability cannot be guaranteed. This is not an indication of a problem with the player.

IMPORTANT: THIS MODEL HAS A MOTORIZED ELECTRONIC CD DOOR. DO NOT ATTEMPT TO OPEN THE DOOR MANUALLY. THIS COULD CAUSE DAMAGE TO THE DOOR OPENING MECHANISM.

- 1.) Slide the **CD/RADIO** selector switch on the top cabinet to the **CD** position.
- 2.) Press the **STANDBY/ON**  button on the front panel or on the remote control (Model CKD2330 only). The display will show two flashing dashes ("- -") in the track number display.



After a few seconds the track number display will show "00", indicating that there is no disc in the player.



- 3.) Press the **OPEN/CLOSE**  button on the front panel or on the remote control (Model CKD2330 only) once.

IMPORTANT! THERE WILL BE A PAUSE OF APPROXIMATELY TWO SECONDS BEFORE THE POWER PANEL OPENS. PLEASE WAIT. DO NOT PRESS THE OPEN/CLOSE  BUTTON AGAIN.





- 4.) The Power Panel will rotate 90 degrees to allow you to load your disc in the CD player. Before loading your own disc be sure to remove the dummy CD transit card from the player and discard it.
- 5.) Place your disc on the center spindle with the printed label side facing you. Gently press on the disc near the center hole to insure that the disc is properly 'seated' on the spindle.

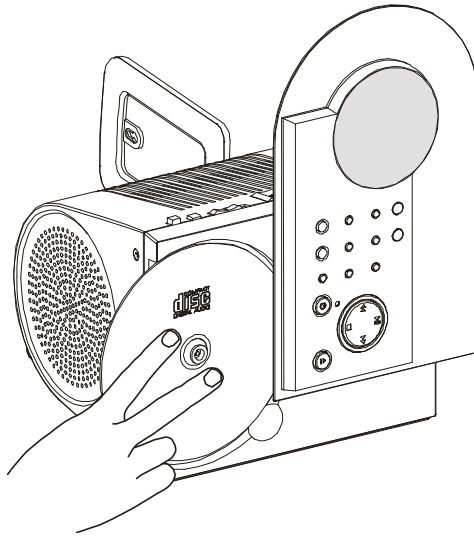

- 6.) Press the **OPEN/CLOSE ▲** button on the front panel or on the remote control (Model CKD2330 only). The Power Panel will return to its closed position. The disc will spin for a few seconds while the player reads the TOC (Table of Contents) on the disc. Then the disc will stop spinning and the display will show the total number of tracks on the disc.

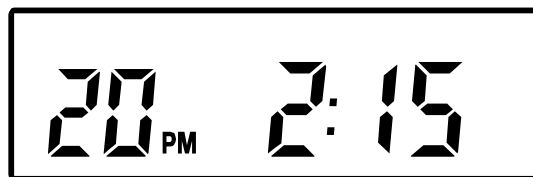



- 7.) Press the **PLAY/PAUSE** ►|| button on the front panel or on the remote control (Model CKD2330 only). Playback begins on track 1 and the **PLAY** indicator appears in the display.



Adjust the **VOLUME** controls to the desired level.

- 8.) Playback will continue until the last track has played then the disc stops, the **PLAY** indicator disappears, and the display again shows the total number of tracks on the disc. To stop playback before the disc ends press the **STOP** ■ button on the front panel or on the remote control (Model CKD2330 Only) at any time. The disc stops and the display shows the total tracks on the disc.
- 9.) If you are finished listening press the **OPEN/CLOSE** ▲ button on the front panel or on the remote control (Model CKD2330 Only), wait for the two-second delay before the Power Panel opens. When the panel opens, gently remove your disc from the player, and then press the **OPEN/CLOSE** ▲ button again to close the Power Panel.
- 10.) To listen to the radio slide the **CD/RADIO** selector switch back to the Radio position, or press the **STANDBY/ON** ⏻ button to return the system to the Standby (Power Off) mode.



PAUSE Control

To pause momentarily during CD playback press the **PLAY/PAUSE** ►|| button on the front panel or on the remote control (Model CKD2330 only) again. The sound stops and the **PLAY** indicator flashes but the disc continues to spin.



Press the **PLAY/PAUSE** ►|| button again to cancel the Pause mode and resume normal playback. The sound resumes at the same point on the disc and the **PLAY** indicator stops flashing.

SKIP/SEARCH Controls (►► / ◀◀)

During playback press the **SKIP Forward** ►► or **SKIP Reverse** ◀◀ buttons on the front panel or on the remote control (Model CKD2330 Only) repeatedly to skip forward or back to higher or lower numbered tracks. Playback will start at the beginning of the selected track.

To search within a track for a specific musical passage depress and hold the **SKIP Forward** ►► or **SKIP Reverse** ◀◀ buttons on the front panel or on the remote control (Model CKD2330 Only). The player will search rapidly forward or backward as long as the buttons are depressed. When you hear the desired passage release the buttons and normal playback will resume at that point.

To start playback from a specific track load your disc as usual and wait until the display shows the total number of tracks. Press the **SKIP Forward** ►► or **SKIP Reverse** ◀◀ buttons repeatedly until the desired track number appears in the display then press the **PLAY/PAUSE** ►|| button to begin playback on the desired track.



SPECIAL PLAYBACK MODES

REPEAT Playback

You can program the player to continuously repeat a single track or the entire disc. The Repeat mode can be selected while the disc is playing or while the disc is stopped.

Single Track Repeat

Select the track to be repeated and then press the **REPEAT** button on the front panel once. The **REPEAT** indicator begins flashing in the display. If necessary, press the **PLAY/PAUSE** ►|| button to begin playback. The selected track will be repeated continuously.



All Tracks Repeat

Press the **REPEAT** button on the front panel twice. The **REPEAT** indicator remains in the display. If necessary, press the **PLAY/PAUSE** ►|| button to begin playback. The entire disc will be repeated continuously.



To cancel Repeat playback press the **REPEAT** button on the front panel until the **REPEAT** indicator no longer appears in the display. Repeat Playback mode may also be canceled by pressing the **STOP** ■ button twice, switching to Radio function, or pressing the **STANDBY/ON** ⏻ button to shut the power 'Off'.





RANDOM Playback (Model CKD2330 Only)

When the Random Playback mode is selected all the tracks on the disc will be played in random order. Random Playback mode can be selected while the disc is playing or while the disc is stopped.

Press the **RANDOM** button on the remote control (Model CKD2330 Only). There is no Random button on the front panel. The **RANDOM** indicator appears in the display. If necessary, press the **PLAY/PAUSE** ►|| button to begin playback.



The player will randomly select a track and begin playback. After each track plays once the player stops and the display again shows the total number of tracks on the disc. However the **RANDOM** indicator remains in the display.

To cancel Random Playback press the **RANDOM** button again until the **RANDOM** indicator disappears. Random playback may also be canceled by pressing the **STOP** ■ button twice, switching to Radio function, or pressing the **STANDBY/ON** ⏻ button to shut the power 'Off'.



PROGRAMMED PLAYBACK

Use the Programmed Playback feature to play up to 20 tracks on a disc in any desired order. You may also program a particular track to play several times within a programmed sequence if desired.

NOTES:

- (A.) You cannot program a disc while it is playing. Press the **STOP** ■ button to stop playback and then follow the programming steps below.
- (B.) Programming is only possible with the front panel control. There is no **PROGRAM** button on the remote control.

- 1.) Load your disc as usual and wait until the display shows the total number of tracks on the disc.

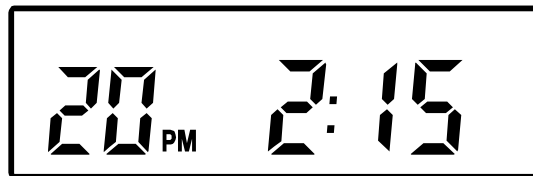

- 2.) Press the PROGRAM button on the front panel. The **PROGRAM** indicator and Program Memory number "01" begin flashing in the display.

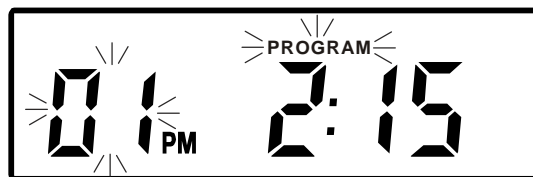



- 3.) Press the **SKIP Forward** ►► or **SKIP Reverse** ◄◄ buttons to select the first track number to be programmed. Example: Track number 7.

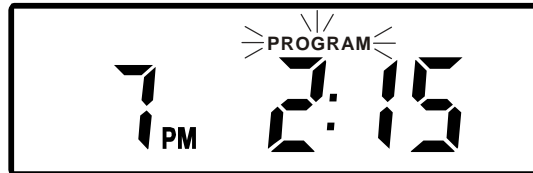

When the desired track number appears in the display press the **PROGRAM** button again. Track 7 is now entered in Program Memory number "01". The program memory number now advances to number "02" and continues flashing.

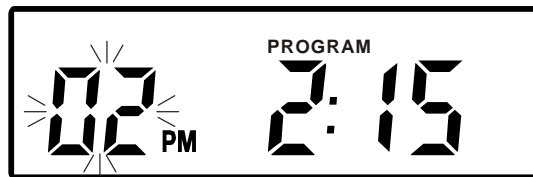

- 4.) Repeat step 3, selecting a different track number each time until you have entered up to 20 tracks in the program memory. To confirm the program after you have entered the last track press the **PROGRAM** button once more. The display will scroll through all the tracks you programmed in sequence.
- 5.) When you have completed programming the desired tracks press the **PLAY/PAUSE** ►|| button to begin programmed playback. The **PLAY** and **PROGRAM** indicators appear in the display. Playback will begin on the first track you programmed and will continue until the last programmed track has played.





6.) When the program is completed the player stops and the display again shows the total tracks on the disc. However the **PROGRAM** indicator remains in the display and the player remains in the Programmed Playback mode.



If you press the **PLAY/PAUSE** ►|| button the programmed sequence will play again. To cancel the Programmed Playback mode press the **STOP** ■ button while the player is stopped. The **PROGRAM** indicator goes off. Programmed Playback may also be canceled by switching to Radio function, or pressing the **STANDBY/ON** ⏻ button to shut the power 'Off'.



Programmed Repeat Playback



You may use the Programmed Playback and Repeat features together to continuously repeat a programmed sequence. First program the desired sequence according to steps 1 through 5 on pages 24-25. When Programmed Playback begins press the **REPEAT** button twice to select the Repeat All Tracks mode. The **REPEAT** indicator appears in the display together with the **PROGRAM** and **PLAY** indicators. The programmed sequence will be repeated continuously.









ALARM Function

You can use the alarm function to wake you to an electronic buzzer tone, the radio, or your favorite CD.





First press the **ALARM SET** button on the front panel to check the Wake Up time setting. Adjust the Wake Up time if necessary. Then press the **ALARM ON/OFF** button on the top panel. The Alarm "On" indicator  appears in the display.



Wake To Buzzer





Press the **STANDBY/ON**  button to put the system in the Standby (Power 'Off') mode. Set the **MUSIC**  /**BUZZER**  switch on the top panel to the **BUZZER**  position. At the selected wake up time the buzzer will sound. It will continue for one hour and then shut off automatically. To stop the alarm sooner press the **ALARM ON/OFF** button once or **STANDBY/ON**  button on the front panel.

Wake To Radio



Tune to the desired radio station and adjust the volume to the level you want to hear in the morning when the alarm comes on. Press the **STANDBY/ON**  button to put the system in the Standby (Power 'Off') mode. Set the **MUSIC**  /**BUZZER**  switch on the top panel to the **MUSIC**  position. At the selected wake up time the radio will turn on. It will continue for one hour and then shut off automatically. To stop the radio sooner press the **ALARM ON/OFF** button once or **STANDBY/ON**  button on the front panel.



Wake To CD

Load the desired CD, begin playback and adjust the volume to the desired level. Press the **STANDBY/ON**  button to put the system in the Standby (Power 'Off') mode. Set the **MUSIC**  / **BUZZER**  switch on the top panel to the **MUSIC**  position. At the selected wake up time the CD will begin to play. It will continue for one hour, or until the end of the disc, and then shut off automatically. To stop the CD sooner, press the **ALARM ON/OFF** button once or **STANDBY/ON**  button on the front panel.

Automatic Alarm Repeat

The Alarm will automatically repeat each day at the selected Wake Up time as long as the Alarm indicator  appears in the display. To cancel the alarm, press the **ALARM ON/OFF** button on the top panel until the Alarm indicator  disappears.

Note: When the Alarm is turned "On", the Standby LED indicator will flash.

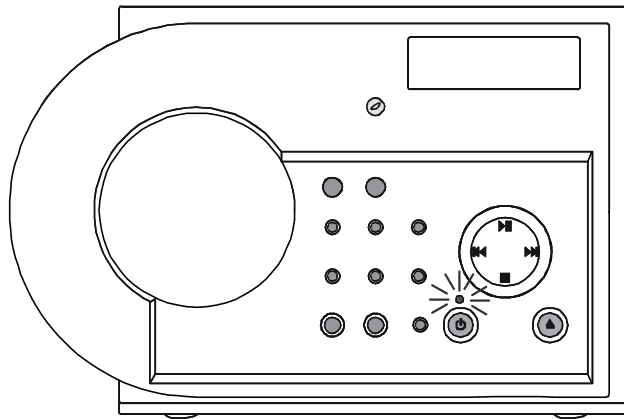



SNOOZE Function

After the alarm turns on in the morning you can use the Snooze function to grab a few more minutes sleep before the alarm sounds again. To activate the Snooze function you can press the **SNOOZE** button on the top cabinet, or you can simply wave your hand in front of the Snooze Sensor on the front panel.

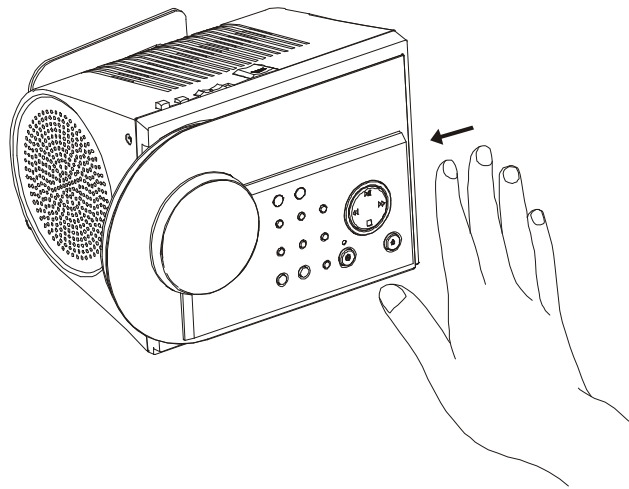

The effective operating range of the Snooze Sensor is approximately 2 inches. The Snooze function will stop the alarm for 5 minutes and then turn the alarm on again. The Snooze operation can be repeated several times within one hour. But after one hour the alarm will not turn on again.

Remote Snooze Operation (Model CKD2330 Only)

After the alarm comes on in the morning you may also activate the SNOOZE function by pressing any button on the remote control **EXCEPT THE STANDBY/ON BUTTON.** The alarm will stop for 5 minutes and then turn on again.

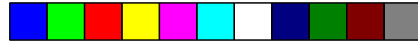

SLEEP TIMER (Front Panel Only)

This system includes a programmable Sleep Timer that allows you to fall asleep from **59** minutes of music and then shuts the power 'Off' automatically.

To Operate The Sleep Timer:

- 1.) Turn the system 'On' and operate either the Radio or CD function as usual.
- 2.) Adjust the Volume level controls to the desired level. Remember that the level you select for the sleep to music function is the same level you will hear when the timer turns the system on in the morning.
- 3.) Press and hold the **SLEEP** button on the front panel. There is no SLEEP button on the remote control.
- 4.) The display will show "0:59" indicating that the sleep timer will shut the power off after 59 minutes. The **SLEEP** indicator flashes in the display. Continue holding the **SLEEP** button to decrease the amount of Sleep Timer operation. Release the **SLEEP** button when the display shows the desired amount of Sleep time.



- 5.) The Sleep Time display disappears. The **SLEEP** indicator stops flashing. When the Sleep Timer counts down to "00", the power shuts off automatically.

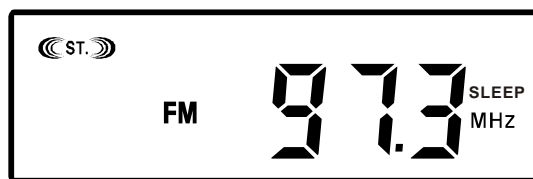



NOTES:



- You can shut the unit off manually before the Sleep Timer counts down to “00” by pressing the **STANDBY/ON**  button at any time. Or just cancel the Sleep Timer by pressing the **SNOOZE** button.
- Remember that if you are falling asleep to CD you will also wake to CD, and if you fall asleep to the radio you will also wake to the radio.
- If you are falling asleep to CD, the system will only operate until the CD ends. If you set the Sleep Timer for 59 minutes but your CD is only 45 minutes long, the music will stop after 45 minutes.

IMPORTANT:

*When the SLEEP function is on, the Radio Frequency will always appear on the display. The **CLOCK SET** and **ALARM SET** functions will be disabled, you can still check the ALARM wake up time by pressing the **ALARM SET** button, but pressing the **CLOCK SET** button has no effect during Sleep Timer operation.*

Power Failure During Sleep Timer Operation

If you experience a power failure during Sleep Timer operation an incorrect time (such as "3545") may appear on the display. If this occurs please perform the following steps to correct the time display:

- 1.) Press the **STANDBY/ON**  button to turn the system 'On'.
- 2.) Press the **SLEEP** button once.
- 3.) Press the **STANDBY/ON**  button again to turn the system 'Off'.

The time display will return to normal.



MUTE Function (Model CKD2330 Only)

To stop the sound from the speakers temporarily press the **MUTE** button on the remote control handset. The Mute indicator light (red) comes on. The sound stops but the unit remains 'On'. Press the **MUTE** button again to cancel Mute function and restore the sound. The Mute indicator light (red) goes off.

Display Dimmer

The brightness of the display is automatically adjusted for the room light conditions. The display brightness will be reduced when the room lighting is tuned off so as not to interfere with your sleep. The display will brighten automatically in daylight or when the room lights are turned on again for better visibility.

Headphone Jack

The Stereo Headphone Jack is located on the right side panel. Connect a set of stereo headphones (not included) to this jack for private listening without disturbing others. The internal speakers are automatically disconnected when headphones are connected to the headphone jack.

IMPORTANT: *When using headphones always set the volume control to a low level before you put the headphones on. Then put the headphones on and gradually increase the volume to a comfortable listening level.*



CARE AND MAINTENANCE

COMPACT DISC CARE

- To remove a disc from its storage case, press down on the center of the case and lift the disc out, holding it carefully by the edges.

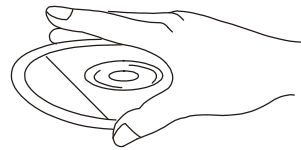
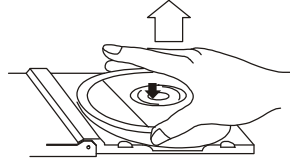

- Fingerprints and dust should be carefully wiped off the disc's recorded surface with a soft cloth. Unlike conventional records, compact discs have no grooves to collect dust and microscopic debris, so gently wiping with a soft cloth should remove most particles. Wipe in a straight line from the inside to the outside of the disc. Small dust particles and light stains will have absolutely no effect on reproduction quality.

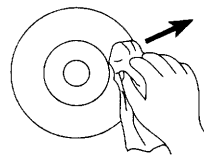
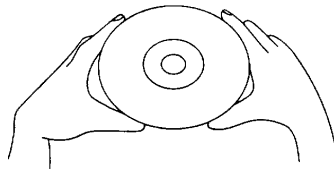

- Clean the disc periodically with a soft, lint-free, dry cloth. Never use detergents or abrasive cleaners to clean the disc. If necessary, use a CD cleaning kit.
- Never write on or affix labels to the surface of compact discs.

CARE OF THE CABINET

If the cabinet becomes dusty wipe it with a soft dry dust cloth. Do not use any wax, polish sprays, or abrasive cleaners on the cabinet.

CAUTION

Never allow any water or other liquids to get inside the unit while cleaning.

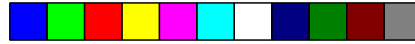

LIMITED WARRANTY

Emerson Radio Corp. warrants manufacturing defects in original material, including original parts and workmanship, under normal use and conditions, for a period of ninety (90) days from the date of original purchase in the U.S. With your dated proof of purchase, we will provide repair service at no charge for labor and parts at an authorized Depot Repair Facility, or replace the product in our discretion. For repair or replacement, pack your unit in a padded box, enclose your check or money order payable to Emerson Radio Corp. in the amount of \$9.00 (not required by California residents) to cover shipping and handling costs, and enclose a copy of your proof of purchase. Send your unit to:

Emerson Radio Corp.
1901 Diplomat Drive.
Farmers Branch, TX 75234.

This warranty does not cover damage from negligence, misuse, abuse, accident, failure to follow operating instructions, commercial use, rental, repairs by an unauthorized facility, or products purchased, used, serviced or damaged outside of the United States.

THIS WARRANTY GIVES YOU SPECIFIC LEGAL RIGHTS, AND YOU MAY ALSO HAVE OTHER RIGHTS WHICH VARY FROM STATE TO STATE.

AU898M

 Emerson [®] SERVICE	TO FIND THE LOCATION AND PHONE NUMBER OF YOUR NEAREST SERVICE CENTER PERMITTED TO PERFORM WARRANTY...
CALL TOLL FREE: 1-800-695-0098	
FOR ADDITIONAL SET-UP OR OPERATING ASSISTANCE PLEASE CALL: 1-800-898-9020	
FOR CUSTOMER SERVICE, PLEASE WRITE TO: Emerson Radio Corp. Consumer Affairs Dept. 1901 Diplomat Drive, Farmers Branch, TX 75234.	



EMERSON
Part No.: 16-2911B
309-01

Printed in China