



# IMPRESSA E70/75

## Instructions for use



Art. Nr. 62564

IMPRESSA

## Legend:

- **DISPLAY** DISPLAY: serves as information.
- **DISPLAY** **DISPLAY**: please follow the instructions shown.

 = Note

 = Important

 = Tip



Fig. 1



Fig. 2



Fig. 3

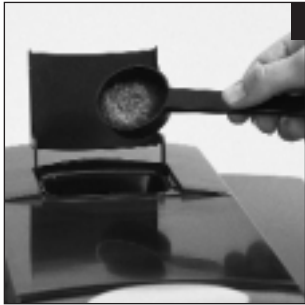

Fig. 4

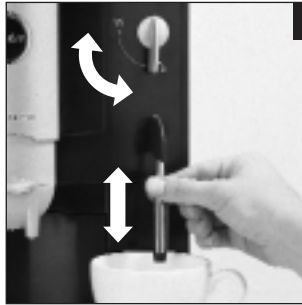

Fig. 5

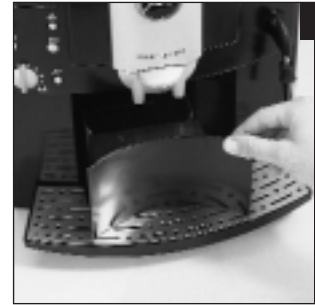

Fig. 6



Fig. 7



Fig. 8

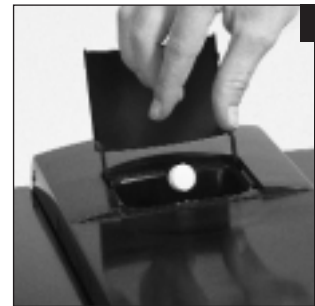
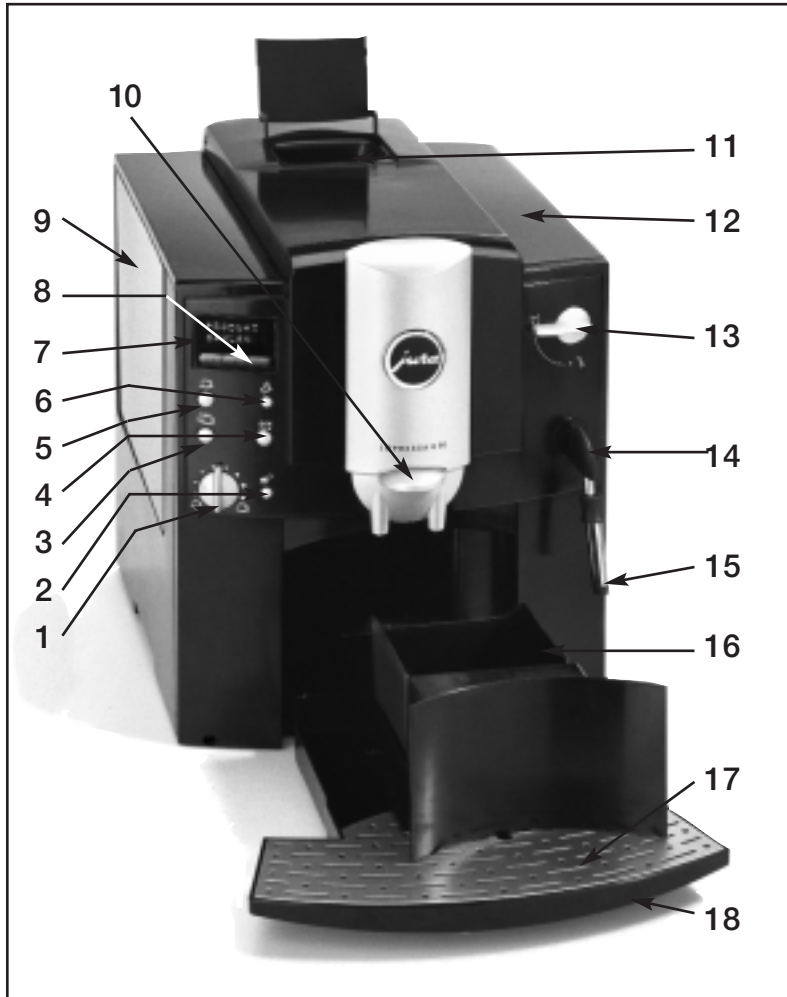

Fig. 9

## Operating elements Jura Impressa E70/75



- 1 Water quantity switch
- 2 Powder coffee selection switch
- 3 Coffee key for 2 cups
- 4 Rinsing-, cleaning-, descaling key
- 5 Coffee key for 1 cup
- 6 ON/OFF switch
- 7 Display dialogue system
- 8 Key P
- 8a Key ◀
- 8b Key ▶
- 9 Water tank with carrying handle
- 10 Height-adjustable coffee spout
- 11 Pre-ground coffee filler funnel
- 12 Cover for bean container
- 13 Selector switch for hot water/steam
- 14 Pivoting nozzle for hot water/steam
- 15 Frothing aid
- 16 Container for coffee grounds
- 17 Drip tray cover
- 18 Drip tray



# Contents

## Jura Impressa E70/75

1. Description .....	page 6	11.1 Programming Filter .....	page 11
2. Safety instructions .....	page 6	11.2 Programming water hardness .....	page 11
2.1 Warnings .....	page 6	11.3 Programming Aroma .....	page 11
2.2 Safety precautions .....	page 6	11.4 Programming automatic switch-off time .....	page 11
3. Preparation of the machine .....	page 7	11.5 Cup counter .....	page 11
3.1 Checking the mains voltage .....	page 7	11.6 Programming language .....	page 11
3.2 Checking the fuse .....	page 7	12. Care and maintenance .....	page 12
3.3 Filling the water tank .....	page 7	12.1 Fill water .....	page 12
3.4 Adding coffee beans .....	page 7	12.2 Empty grounds container .....	page 12
3.5 Adjusting the grinder .....	page 7	12.3 No drip tray .....	page 12
3.6 Adjusting the water hardness .....	page 7	12.4 Fill beans .....	page 12
4. First start of operation .....	page 8	12.5 Clean unit .....	page 12
4.1 Filling system with water .....	page 8	12.6 Unit scaled .....	page 12
5. Rinsing the machine .....	page 8	12.7 Use of Claris filter cartridges .....	page 12
6. Adjusting the water quantity .....	page 9	12.8 Insert filter .....	page 13
7. Drawing off espresso/normal coffee .....	page 9	12.9 Replace filter .....	page 13
7.1 Drawing off espresso/strong coffee .....	page 9	12.10 General cleaning instructions .....	page 14
7.2 Drawing off espresso/coffee extra .....	page 9	12.11 Regular service .....	page 14
7.3 Drawing off powder coffee .....	page 9	12.12 Empty system .....	page 14
8. Drawing off steam .....	page 10	13. Cleaning .....	page 14
8.1 Return to stand-by .....	page 10	14. Descaling .....	page 15
9. Drawing off hot water .....	page 10	15. Disposal .....	page 16
10. Switching machine off .....	page 11	16. Tips for perfect coffee .....	page 16
11. Programming .....	page 11	17. Messages .....	page 17
		18. Problems .....	page 18
		19. Legal information .....	page 19
		20. Technical data .....	page 19

## Important information for the user

Thank you for choosing this Jura product.

Please study these instructions carefully before using your new machine for the first time and keep them in safe place for easy reference in future.

Should you require further information or should particular problems occur that are not dealt with in sufficient detail for you in these operating instructions, please contact your local dealer or us for the information you require.

## 1. Description

This fully automatic espresso/coffee machine impresses because of its compactness. In just one brewing process, it can prepare 1 or 2 cups of excellent, professional-quality espresso/coffee with guaranteed froth. The unique Jura pre-brew system (Intelligent Pre Brew Aroma System/I.P.B.A.S<sup>®</sup>) ensures full use of the coffee aroma. The machine works fully automatically at the push of a button. With the coffee aroma, you have the choice between normal, strong and extra strong, depending on taste. The integrated grinder grinds the beans to the required fineness. A separate filler funnel makes it possible to use additional, pre-ground sorts of coffee. The water quantity can be set individually. Electronic filling controls for the water tank and container for coffee grounds simplify operation. A plain-text display gives you information and makes operation particularly easy. Thanks to the integrated rinsing, cleaning and de-scaling programmes, care and maintenance are also quick and easy.

## 2. Safety instructions

### 2.1 Warnings

- Children are unaware of the dangers that electrical machines can represent; for this reason, children should never be left unsupervised with electrical machines.
- This machine should only be used by people who have read these instructions.
- Never use a faulty machine or one with a damaged power cable.
- Never immerse the machine in water.

### 2.2 Safety precautions

- Never subject the machine to the effects of the weather (rain, snow, frost) and never operate it with wet hands.
- Place your machine on a solid level surface. Never leave it on a surface which is warm or hot (hob etc.). Choose a location which is inaccessible for children or for pets.
- Always pull the plug out if you are away for a long time (holidays etc.).
- Always pull the plug out first before cleaning.
- When pulling the plug out, never tug on the cord or on the machine itself.
- Never repair or open the machine yourself. All repairs should be done by authorised service centres only using original Jura spare parts and accessories.
- The machine is connected to the mains power socket via an electric cable. Make sure that nobody trips over it and pulls the machine down. Keep children and pets well away from the machine.
- Never put the machine or even parts of it into the dishwasher.
- Choose a place with a good circulation of air in order to prevent the machine from overheating.

### 3. Preparation of the machine

#### 3.1 Checking the mains voltage

The machine is set to the correct voltage before leaving our factory. Ensure that your mains voltage corresponds to the details quoted on the rating plate attached to the bottom of the machine.

#### 3.2 Checking the fuse

The machine is designed for a current of 10 Amps. Check that the fuse used matches this.

#### 3.3 Filling the water tank

- Remove the water tank and rinse it out well with cold tap water (Fig. 1).
- Then fill the water tank and put it back into the machine. Ensure that the tank engages properly.

 Only use fresh, cold water. Never fill with milk, mineral water or other fluids. You can also add water without removing the tank. Simply lift the lid up and pour in water from above with a vessel. Close the lid again.

#### 3.4 Adding coffee beans

- Lift up the cover of the bean container (12).
- Clean out any dirt or foreign objects from the bean container.
- Pour coffee beans into the bean container and close the cover again.

### 3.5 Adjusting the grinder

You have the possibility of adjusting the grinder to the roast of your coffee. We recommend the following:

for a light roast → a finer adjustment  
for a dark roast → a coarser adjustment

- Open the cover of the bean container (12).
- To adjust the grinding, turn the selector switch (Fig. 2) to the required position.
- You have the following possibilities:
  - the smaller the dots, the finer the grinding
  - the larger the dots, the coarser the grinding

 the degree of grinding should only be adjusted with the grinder in operation.

### 3.6 Adjusting the water hardness

Water is heated inside the machine. This leads to calcium deposits (scale) during use. This is automatically displayed.

Before you use your machine for the first time, you must adjust it to the hardness of the local water. For this purpose, please use the enclosed test sticks.





 1° German water hardness corresponds to 1.79° French water hardness.

The machine has 5 hardness settings to choose from. During the setting, the water hardness selected is shown on the display.



The symbols on the display mean:

HARDNESS LEVEL —	Water hardness function switched off
HARDNESS LEVEL 1	German water hardness 1 – 7° French water hardness 1.79 – 12.53°
HARDNESS LEVEL 2	German water hardness 8 – 15° French water hardness 14.32 – 26.85°
HARDNESS LEVEL 3	German water hardness 16 – 23° French water hardness 28.64 – 41.14°
HARDNESS LEVEL 4	German water hardness 24 – 30° French water hardness 42.96 – 53.7°

The machine is adjusted to **HARDNESS LEVEL 3** in the factory. You can alter this setting by proceeding as follows:

- Pull the plug and the feed wire out of the wire box on the back of the machine.
- Put the plug in.
- Switch the machine on by pressing the ON/OFF  key.  
The machine goes into the starting position fully automatically.
- **DISPLAY PLEASE WAIT**
- Press the key P until you hear an acoustic signal.
- **DISPLAY FILTER NO**
- Press the key  a number of times in succession until the following report appears:
- **DISPLAY HARDNESS LEVEL 3**
- If you press key P, you hear an acoustic signal and the hardness level you have set flashes.
- If you press the keys  and  you can now set the required hardness level.

When you have selected the corrected hardness level, press the key P once more as a confirmation. You can hear an acoustic signal.

- Press the keys  and  until the following report appears:
- **DISPLAY EXIT**
- Press the key P to return to stand-by status.

## 4. First start of operation

### 4.1 Fill system with water

- Switch your machine on with the ON/OFF  switch.  
The machine goes into the starting position fully automatically.
- Place an empty cup under the pivoting nozzle (14).
- **DISPLAY PLEASE WAIT**
- **DISPLAY OPEN TAP**
- **DISPLAY SYSTEM FILLING / PLEASE WAIT**  
The flow of water stops automatically.
- **DISPLAY CLOSE TAP**

## 5. Rinsing the machine

- **DISPLAY RINSE UNIT**
- Place an empty cup under the coffee-spout (10).
- Press the rinsing key .

 If the machine has been switched off and has already cooled down, the rinsing function will be demanded when the machine is switched on.

A rinsing is automatically started when the machine has been switched on.



## 6. Adjusting the water quantity

The water quantity can be infinitely adjusted with rotary knob (1). The small key means little water for espresso, the large cup means a lot of water for coffee.

### ■ **DISPLAY** SELECT PRODUCT

- Turn the water quantity rotary knob into the position at which the required amount of water appears on the display:

30 ML – 90 ML ESPRESSO  
100 ML – 240 ML COFFEE

- ➔ You can also alter the water quantity during the process. Simply turn the water quantity rotary knob (1) to more or less ml.

- 💡 The information in ml is a guideline and can deviate from the effective amount.

- ➔ With draw-off key  the machine automatically doubles the water quantity and distributes it to 2 cups.

## 7. Drawing off espresso/normal coffee

- Switch your machine on with the ON/OFF  key.

### ■ **DISPLAY** PLEASE WAIT

### ■ **DISPLAY** RINSE UNIT

Place an empty cup under the height-adjustable coffee-spout (10) and press the rinsing key

### ■ **DISPLAY** UNIT RINSING

### ■ **DISPLAY** SELECT PRODUCT

- Place 1 or 2 cups, as necessary, under the height-adjustable coffee-spout (10) and press the required draw-off key. The pre-brew system (I.P.B.A.S.©) moistens the coffee powder, briefly interrupts the flow and then starts the actual brewing process.

- ➔ You can interrupt the draw-off prematurely by pressing any of the coffee draw-off keys.

- 💡 In order to obtain outstanding froth, you can adapt the height-adjustable coffee-spout (10) individually to the size of your cups (Fig. 3).

## 7.1 Drawing off espresso/strong coffee

- Place 1 cup under the height-adjustable coffee-spout (10) and press the required coffee key until the following report appears:

### ■ **DISPLAY** ESPRESSO STRONG or COFFEE STRONG

- ➔ This draw-off of espresso / strong coffee is only possible for 1 cup.

## 7.2 Drawing off espresso/coffee extra

- Place 1 cup under the height-adjustable coffee-spout (10) and press the required coffee key until the following report appears:

### ■ **DISPLAY** ESPRESSO EXTRA or COFFEE EXTRA

- ! This draw-off of espresso / strong coffee is only possible for 1 cup.

## 7.3 Drawing off powder coffee

- Press the selector switch .



### ■ **DISPLAY** FILL POWDER

- Now put 1 or 2 level measuring spoons of pre-ground coffee into the filler funnel for pre-ground coffee (Fig. 4).

- Place 1 or 2 cups under the height-adjustable coffee-spout (10) and press the required coffee key.

### ■ **DISPLAY** ESPRESSO POWDER or COFFEE POWDER



 Never use water-soluble instant coffee or quick coffee. We recommend that you only use powder from freshly ground coffee beans or pre-ground, vacuum-packed coffee. **Never put more than 2 portions of coffee in. The filler funnel is not a storage container.** Make sure that the coffee powder which you use is not ground too finely. This can lead to blockages, and the coffee then only runs through drip by drip.

 If draw-off key  is pressed by mistake, the selection can be cancelled by pressing the selection can be cancelled by pressing the rinsing key . Your machine rinses.

 After drawing off powder coffee, we recommend that you regularly clean the filler funnel with a clean bottle-cleaning brush.

## 8. Drawing off steam

The steam can be used for heating liquids and also for frothing milk for cappuccino. Make sure that the frothing aid (15) is pushed upwards when heating liquids. When frothing liquids, push the frothing aid downwards (Fig. 5).

- Place a cup under the pivoting nozzle (14).
- Immerse the frothing aid (15) into the milk to be frothed or the liquid to be heated and turn the steam/hot water rotary button (13) to the position  (Fig. 5).
- **DISPLAY** STEAM → ← WATER / SELECT PRODUCT
- Press the key .
- **DISPLAY** STEAM INTAKE / PLEASE WAIT
- **DISPLAY** STEAM INTAKE
- When you have reached the required quantity of steam, turn the steam/hot water rotary knob back to the position .

■ **DISPLAY** STEAM INTAKE / SELECT PRODUCT

■ If you would like to draw off a coffee immediately after the steam, please proceed as described in point 8.1.

 The max. draw-off time is about 4 minutes. A little water will come out first when frothing. It can be let off before actually drawing off steam. The good result, e.g. when frothing milk, is not influenced in any way.



 At the start of a steam draw-off, there can be splashes. The pivoting nozzle gets hot. Please avoid direct contact with the skin.

## 8.1 Return to stand-by

- Place a vessel under the pivoting nozzle (14).
- **DISPLAY** STEAM READY / SELECT PRODUCT
- Press a draw-off key.
- **DISPLAY** OPEN TAP
- **DISPLAY** SYSTEM FILLING / PLEASE WAIT
- **DISPLAY** CLOSE TAP

 After each steam draw-off, clean the pivoting nozzle with a damp cloth.

## 9. Drawing off hot water

- Place a cup under the pivoting nozzle (14) and turn the steam/hot water rotary knob (13) to the symbol .
- **DISPLAY** STEAM → ← WATER / SELECT PRODUCT
- Press the key .
- **DISPLAY** WATER INTAKE

- When you have reached the required quantity of hot water, turn the steam/hot water rotary knob (15) back to the position .
- **DISPLAY** SELECT PRODUCT

 At the start of a water draw-off, there can be splashes. The pivoting nozzle gets hot. Please avoid direct contact with the skin.

## 10. Switching machine off

When the machine is switched off, the rinsing programme is automatically started. Therefore, place an empty container under the coffee-spout and press the ON/OFF  switch.

When the rinsing water has run into the cup, the machine switches off. Throw the rinsing water away.

## 11. Programming

Before leaving our factory, the machine is adjusted so that you can draw off coffee without additional programming. In order to adapt the result to your taste, various settings can be programmed individually. You will find the programming keys under the display.

The following settings can be programmed:

- Filter
- Water hardness
- Aroma
- Automatic switch-off time
- Draw-off and cup counter
- Language selection
- Exit

### 11.1 Programming Filter

Please read chapter 12.8 “Insert filter”.

### 11.2 Programming water hardness

Please read chapter 3.6 “Adjusting water hardness”

### 11.3 Programming Aroma

- **DISPLAY** AROMA INTENSIVE
- Press the key P, an acoustic signal is heard.
- By pressing keys ◀ and ▶ you can select the required setting (INTENSIVE or MILD) and then confirm it with key P.
- By pressing key ▶ you can select the next level.

### 11.4 Programming automatic switch-off time

- **DISPLAY** OFF AFTER 5.0 HRS.
- Press the key P, an acoustic signal is heard.
- **DISPLAY** 5.0 flashes.
- By briefly pressing keys ◀ and ▶ you can set the hours and then confirm them with key P. (0.5 – 9 hrs.)
- By pressing key ▶ you can select the next level.

### 11.5 Cup counter

- **DISPLAY** 10 SUPPLIED (total of draw-offs)
- To obtain the information, press the required draw-off key, and you will be told how often the selected function has been chosen.
- By pressing key ▶ you can select the next level.

### 11.6 Programming language

- Press the key P.
- By briefly pressing the keys ◀ and ▶ you can select the required language and then confirm it with key P.
- Press the keys ◀ or ▶ until the following report appears:

■ **DISPLAY** EXIT

- Press the key P to return to stand-by status.

## 12. Care and maintenance

### 12.1 Fill water

■ **DISPLAY** FILL WATER

- When this display lights up, no drawing-off is possible. Fill with water as described under point 3.3.

### 12.2 Empty grounds container

The grounds container collects the coffee grounds.

■ **DISPLAY** EMPTY GROUNDS

- When this display lights up, no drawing-off is possible and the grounds container must be emptied (Fig. 6).
- Remove the drip tray. Be careful, as there is water in it.

 Do **not** disconnect the machine from the mains when emptying the grounds.

### 12.3 No drip tray

■ **DISPLAY** TRAY MISSING

- When this display lights up, the drip tray has not been inserted properly.

 If the drip tray has not been put into the machine, you can clean the interior of the machine. Wipe out any coffee powder that might be in the machine with a damp cloth. Put the drip tray back in again.

## 12.4 Fill beans

■ **DISPLAY** FILL BEANS

- Fill beans as described in Chapter 3.4.

 The display FILL BEANS only goes off after coffee has been drawn off.  
We recommend cleaning the bean container from time to time with a dry cloth before you refill beans. Switch the machine off for this purpose.

## 12.5 Clean unit

■ **DISPLAY** CLEAN UNIT

After 200 draw-offs or 160 rinses, the machine must be cleaned; the display announces this. You can continue to draw off coffee or hot water/steam. We recommend carrying out the cleaning (as described in point 13) within the next few days.

## 12.6 Unit scaled

■ **DISPLAY** UNIT CAL. FIED





Scale is caused by using the machine and depends upon the hardness level of your water. The machine recognises the necessity of descaling. You can continue to draw off coffee or hot water/steam. We recommend carrying out the descaling (as described in point 14) within the next few days.

## 12.7 Use of Claris filter cartridges

If the Claris filter cartridges are used correctly, your machine no longer needs descaling. You can obtain more information from the brochure “Claris. Hard on scale. Gentle to your coffee machine.” (enclosed in the water tank).

 If you use the Claris filter cartridges, you must firstly switch off the descaling display (as described in point 3.6).

## 12.8 Insert filter

- Pull up the cartridge holder. Pressing gently, put the filter cartridge into the water tank (Fig. 7).
- Close the cartridge holder until it engages audibly.
- Fill the water tank with cold fresh tap water and put it back into the machine.
- Switch the machine on with the ON/OFF  switch.
- Press the key P until you hear an acoustic signal.
- **DISPLAY** FILTER NO
- Press the key P, and an acoustic signal is heard
- **DISPLAY** NO flashes
- You can change the setting by pressing the keys  and .
- **DISPLAY** YES flashes.
- To confirm, press the programming key P again until you hear an acoustic signal.
- **DISPLAY** RINSE FILTER / OPEN TAP
- Place a sufficiently large vessel (approx. 1 litre) under the pivoting nozzle (16) and turn the selector switch for coffee or hot water / steam to the position .
- **DISPLAY** PLEASE WAIT/FILTER RINSING. The water draw-off stops automatically.
- **DISPLAY** CLOSE TAP
- **DISPLAY** SELECT PRODUCT



 The water can be slightly discoloured (not dangerous to health)

## 12.9 Replace filter

After 50 litres have been drawn off, the filter loses its effect.

- **DISPLAY** REPLACE FILTER / SELECT PRODUCT

If you do not draw off often, you should replace the filter cartridge every 2 months, but no report appears on the display. There is a special disk on the cartridge holder so that you can set the replacement date.

- Switch your machine on with the ON/OFF  switch.
- Press the key P until you hear an acoustic signal.
- **DISPLAY** FILTER YES
- Press the key .
- **DISPLAY** REPLACE FILTER
- Empty the water tank and lift up the cartridge mounting. Pressing gently, put the new filter cartridge into the water tank (Fig. 7)
- Close the cartridge mounting until it engages audibly.
- Fill the water tank with cold fresh tap water and put it back into the machine again.
- Press the key P until you hear an acoustic signal.
- **DISPLAY** Display RINSE FILTER / OPEN TAP
- Place a sufficiently large vessel (approx. 1 litre) under the pivoting nozzle (14) and turn the selector switch for coffee or hot water / steam to the position .
- **DISPLAY** FILTER RINSING / PLEASE WAIT. The water draw-off stops automatically.
- **DISPLAY** CLOSE TAP
- **DISPLAY** SELECT PRODUCT

 The water can be slightly discoloured (not dangerous to health)

## 12.10 General cleaning instructions

- Never use abrasive articles or corrosive chemicals to clean your machine.
- Wipe down the casing on the inside and out using a soft, damp cloth.
- Clean the pivoting nozzle after each use.
- After heating milk, draw off a little hot water in order to clean the inside of the pivoting nozzle.
- You can take off the frothing aid for a thorough cleaning (Fig. 8).
- The water tank should be rinsed out every day and filled with clean water.



 If there is scale visible in the water tank, you can remove it with a customary descaling agent. Remove the water tank from the machine for this purpose.

## 12.11 Regular service

Regular inspections by Jura Service extend the service life and reliability. Keep the original packaging as transport protection.

## 12.12 Empty system

 This procedure is necessary in order to protect the machine from damage by frost in transport.

- Switch the machine **OFF** with the ON / OFF switch .
- Place a vessel under the pivoting nozzle (14).
- Turn the selector switch for coffee or hot water / steam (13) to position .
- Switch your machine back on again with the ON / OFF switch .
- **DISPLAY** CLOSE TAP

- Press the key  for about 5 seconds.
- **DISPLAY** SYSTEM EMPTYING/PLEASE WAIT. After a short time, steam comes out.
- Draw off steam until the draw-off is automatically stopped.
- **DISPLAY** CLOSE TAP

## 13. Cleaning

The machine has an integrated cleaning programme.

 If the machine needs cleaning, the report appears on the display. You can continue to draw off coffee or hot water/steam and run the cleaning programme later. Only use Jura cleaning tablets. They are available from your Jura dealer.

 You must not interrupt the cleaning programme once it has started.

- Switch your machine on with the ON / OFF key .
- Press the rinsing key for about 3 seconds.
- **DISPLAY** EMPTY TRAY
- Fill the water tank with fresh tap water.

 Place a sufficiently large vessel under the height-adjustable coffee-spout (10), so that the cleaning fluid does not run into the drip tray.

- **DISPLAY** PRESS RINSE
- **DISPLAY** UNIT CLEANING / PLEASE WAIT
- An acoustic signal can be heard.
- **DISPLAY** EMPTY TRAY

 Wait for about 10 seconds before you put the drip tray back in again.

- **DISPLAY** ADD TABLET (Fig. 9) / **PRESS RINSE**
- **DISPLAY** UNIT CLEANING / PLEASE WAIT
- An acoustic signal can be heard.
- **DISPLAY** EMPTY TRAY

 Wait for about 10 seconds before you put the drip tray back in again.

- **DISPLAY** PRESS RINSE
- **DISPLAY** UNIT CLEANING / PLEASE WAIT
- An acoustic signal can be heard.
- **DISPLAY** EMPTY TRAY
- **DISPLAY** SELECT PRODUCT

 After each cleaning operation the filler funnel for the 2nd coffee type should be cleaned.

## 14. Descaling

The machine has an integrated de-scaling programme. If you use a Claris filter cartridge, your machine does not need descaling.



 If the machine needs descaling, the report appears on the display. You can continue to draw off coffee and hot water/steam and then run the descaling programme later.

 Only run the descaling programme when the machine has been switched off for at least 2 hours and has cooled down well. The descaling programme is started with the machine switched off. Once it has started, the descaling programme must not be interrupted.

 Only use Jura cleaning tablets. They are available from your Jura dealer.



- Switch your machine off with the ON / OFF switch  and leave it to cool down for 2 hours.
- Remove the water tank.
- Press the rinsing key for about 3 seconds.
- **DISPLAY** EMPTY TRAY
- **DISPLAY** AGENT IN TANK  
**Completely dissolve the contents of one blister (2 tablets) in 0.5 litres of water in a vessel and pour the mixture into the water tank. Put the tank back in again.**
- **DISPLAY** AGENT TANK / OPEN TAP / PRESS RINSE

 Place a sufficiently large vessel under the pivoting nozzle (14).

- Turn the selector switch for coffee or hot water / steam (13) to position  and press the rinsing key .
- **DISPLAY** UNIT DECALCING / PLEASE WAIT
- An acoustic signal is heard.
- **DISPLAY** EMPTY TRAY
- **DISPLAY** CLOSE TAP
- **DISPLAY** UNIT DECALCING / PLEASE WAIT
- The descaling solution is guided into the drip tray in the interior of the machine.
- An acoustic signal is heard.
- **DISPLAY** EMPTY TRAY
- An acoustic signal is heard.
- **DISPLAY** FILL WATER

 Rinse the water tank out well and fill it with cold fresh tap water. Then put it back into the machine again. Place a sufficiently large vessel under the pivoting nozzle.



- **DISPLAY** FILL WATER / OPEN TAP / PRESS RINSE
- Turn the selector switch for coffee or hot water / steam (13) to position  and press the rinsing key .
- **DISPLAY** UNIT DECALCING / PLEASE WAIT
- An acoustic signal is heard.
- **DISPLAY** EMPTY TRAY
- **DISPLAY** CLOSE TAP
- **DISPLAY** UNIT DECALCING / PLEASE WAIT
- The water is guided into the drip tray in the interior of the machine.
- An acoustic signal is heard.
- **DISPLAY** EMPTY TRAY
- **DISPLAY** RINSE MACHINE
- **DISPLAY** SELECT PRODUCT

## 15. Disposal

For correct disposal, you should return your coffee machine to your dealer, your Jura service centre or the firm of Jura.

## 16. Tips for perfect coffee

### *Height-adjustable coffee-spout*

You can adjust the coffee-spout to the size of your cups

### *Grinding*

See point 3.5

### *Pre-warming cups*

You can pre-warm the cups with hot water or steam. The smaller the amount of coffee, the more important the pre-warming.

### *Sugar and cream*

Heat is lost by stirring the contents. Adding milk or cream from the fridge considerably lowers the temperature of the coffee.



## 17. Messages

<b>DISPLAY</b>	<b>Cause</b>	<b>Action</b>
SYSTEM EMPTY	System empty	Fill system (see point 4.1)
FILL WATER	The tank is empty	Fill with water
	Floater defective	Rinse out or descale water tank
FILL BEANS	The bean container is empty	Fill up with beans
	Although beans have been poured in, the display remains on	Draw off a cup of coffee. "FILL BEANS" only goes off after a draw-off
EMPTY GROUNDS	Grounds container full	Empty grounds container
	Tray replaced too early after emptying	Only replace the tray after about 10 sec.
TRAY MISSING	Drip tray not inserted properly or missing	Insert correctly
CLEAN UNIT	Cleaning necessary	Carry out cleaning according to Chapter
UNIT CAL. FIED	Descaling necessary	Carry out descaling according to Chapter
MALFUNCTION	General fault	1. – Switch off – disconnect from mains – connect to mains – switch machine on
		2. Have machine examined by Jura service centre

## 18. Problems

<b>Problem</b>	<b>Cause</b>	<b>Action</b>
Grinder is very noisy	– foreign body in grinder	– Drawing off coffee with pre-ground powder is still possible – Have machine examined by Jura service centre
Not enough froth when frothing milk	– milk not suitable – frothing aid blocked – frothing aid in wrong position	– use full-cream milk – clean frothing aid – draw off steam (see point 8)
When drawing off coffee, the coffee only flows in drips	– grinding too fine – Coffee powder ground too finely	– set the grinder to a coarser grind – Use a more coarsely ground powder coffee

If the above mentioned messages and/or problems still exist, please contact your dealer or get in touch directly with Jura Elektroapparate AG.

## 19. Legal information

These operating instructions contain the information necessary for the correct use, operation and maintenance of the machine.

Understanding of and complying with the directions contained in these operating instructions are essential for use of the machine without risk and for safety in operation and maintenance.

The operation instructions cannot cover every imaginable example of use. The machine has been designed for use in private households.

We would further like to point out that the contents of these operating instructions in no way constitute a part or, nor do they alter any previous or existing contract, assurance or legal relationship. All obligations on the part of Jura Elektroapparate AG result from the purchase contract in question, which also contains full details of the only warranty regulations applying to this machine. These contractual warranty terms are neither extended nor limited by the information given in these operating instructions.

The operating instructions contain information protected by copyright. Photocopying or translating into another language shall not be admissible without prior written approval by Jura Elektroapparate AG.

## 20. Technical data

Voltage:	230V AC
Power consumption:	1350 W
Fuse:	10 A
Safety check:	
Energy consumption standby:	approx. 3 Wh
Energy consumption ready to make coffee:	approx. 17 Wh
Pump pressure:	max. 15 bar
Water tank:	1.9 litres
Capacity, bean container:	200 gr.
Capacity, grounds container:	max. 16 port.
Cable length:	approx. 1,1 m
Weight:	8,3 kg
Dimensions (B x H x D):	28 x 34,5 x 41,5 cm