

**CAMBRIDGE
SOUNDWORKS®**

A CREATIVE Company

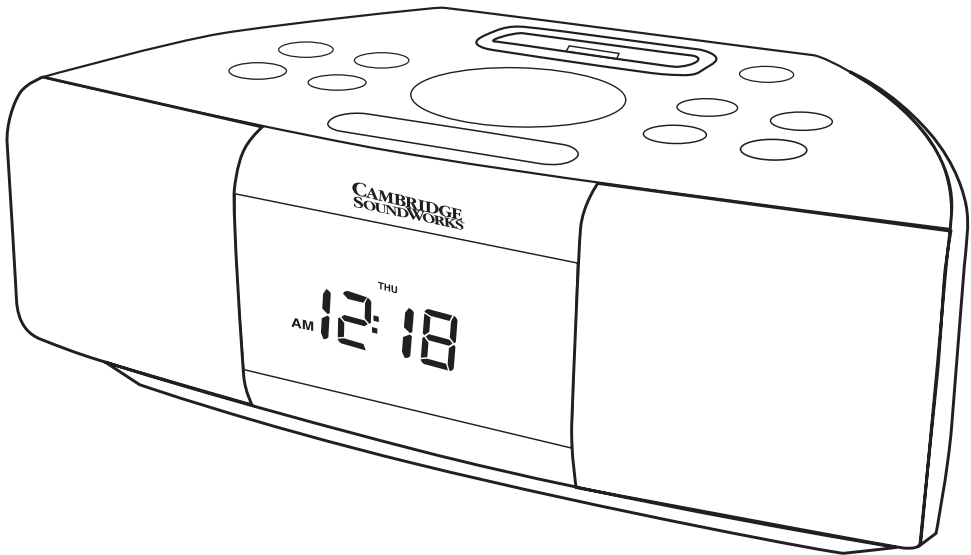

SoundWorks®

i525

USER MANUAL



Made for
iPod

WARNING

DO NOT OPEN
TO PREVENT THE RISK OF ELECTRIC
SHOCK, DO NOT REMOVE COVER. NO
USER-SERVICEABLE PARTS INSIDE. RE-
FER SERVICING TO QUALIFIED SERVICE
PERSONNEL



The lightning flash with arrowhead symbol, within an equilateral triangle, is intended to alert the user to the presence of un-insulated “dangerous voltage” within the product’s enclosure that may be of sufficient magnitude to constitute a risk of electric shock to persons.



The exclamation point, within an equilateral triangle, is intended to alert the user to the presence of important operating and maintenance (servicing) instructions in the literature accompanying the appliance.

SEE MARKING ON BOTTOM/BACK OF PRODUCT

IMPORTANT SAFETY INSTRUCTIONS

- 1) Read these instructions.
- 2) Keep these instructions.
- 3) Heed all warnings.
- 4) Follow all warnings.
- 5) Do not use this apparatus near water.
- 6) Clean only with dry cloth.
- 7) Do not block any ventilation openings. Install in accordance with the manufacturer’s instructions.
- 8) Do not install near any heat sources such as radiators, heat registers, stoves, or other apparatus (including amplifiers) that produce heat.
- 9) Do not defeat the safety purpose of the polarized or grounding-type plug. A polarized plug has two blades with one wider than the other. A grounding type plug has two blades and a third grounding prong. The wide blade or the third prong are provided for your safety. If the provided plug does not fit into your outlet, consult an electrician for replacement of the obsolete outlet.
- 10) Only use attachments/accessories specified by the manufacturer.
- 12) Use only with the cart, stand, tripod, bracket, or table specified by the manufacturer, or sold with the apparatus. When a cart is used, use caution when moving the cart/apparatus combination to avoid injury from tip-over.
- 13) Unplug this apparatus during lightning storms or when unused for long periods of time.
- 14) Refer all servicing to qualified service personnel. Servicing is required when the apparatus has been damaged in any way, such as power supply cord or plug is damaged, liquid has been spilled or objects have fallen into the apparatus, the apparatus has been exposed to rain or moisture, does not operate normally, or has been dropped.
- 15) Do not expose this apparatus to drips or splashes.
- 16) The apparatus shall not be exposed to dripping or splashing and that no objects filled with liquids, such as vases, shall be placed on the apparatus.
- 17) Do not install this apparatus in a confined space such as a book case or similar unit.
- 18) The apparatus draws nominal non-operating power from the AC outlet with its STANDBY/ON switch in the standby position.
- 19) The apparatus should be located close enough to the AC outlet so that you can easily grasp the power cord plug at any time.
- 20) To completely disconnect the power input, the mains plug of the AC/DC adaptor shall be disconnected from the AC mains, as the disconnect device is the mains plug of the AC/DC adaptor.
- 21) Excessive sound pressure from earphones and headphones can cause hearing loss.
- 22) The battery shall not be exposed to excessive heat such as sunshine, fire or the like.



CAUTION

Danger of explosion if battery is incorrectly replaced. Replace only with the same or equivalent type.

Additional Safety Advice

- 1) Keep surrounding objects at least four inches away from the apparatus for adequate ventilation.
- 2) Ventilation openings on the apparatus should not be impeded by such items as newspaper, cloths, curtains, and the like.
- 3) Do not place naked flame sources near the apparatus, such as lighted candles.
- 4) Dispose of the battery in accordance with local safety regulations.
- 5) Do not operate the apparatus at a temperature less than 36° F/ 2° C or greater than 100° F/38° C.

CAUTION

- DO NOT REMOVE THE EXTERNAL ENCLOSURE PARTS TO EXPOSE THE ELECTRONICS. NO USER SERVICE-ABLE PARTS ARE INSIDE.
- IF YOU ARE EXPERIENCING PROBLEMS WITH THIS PRODUCT, CONTACT CREATIVE LABS NORTH AMERICA OR CREATIVE LABS EUROPE FOR A SERVICE REFERRAL. DO NOT USE THE PRODUCT UNTIL IT HAS BEEN REPAIRED.

For CANADA

AC POWER CORD CONNECTION

CAUTION:

TO PREVENT ELECTRIC SHOCK, MATCH WIDE BLADE OF PLUG TO WIDE SLOT, FULLY INSERT.

Pour le CANADA

CORDE DE CONNEXION CA

ATTENTION:

POUR EVITER LES CHOCS ELECTRIQUES, INTRODUIRE LA LAME LA PLUS LARGE DE LA FICHE DANS LA BORNE CORRESPONDANTE DE LA PRISE ET POUSETTUS JUSQU'AU FOND.

WARNING: TO PREVENT FIRE OR SHOCK HAZARD, DO NOT EXPOSE THIS APPLIANCE TO RAIN OR MOISTURE.

FCC STATEMENT FOR THE U. S. A. This equipment has been tested and found to comply with the limits of part 15 of the FCC rules. These limits are designed to provide reasonable protection against harmful interference in a residential installation. This equipment generates, uses, and can radiate radio frequency energy and, if not installed and used in accordance with the instruction, may cause harmful interference to radio communications. However, there is no guarantee that interference will not occur in a particular installation. If this equipment does cause harmful interference to radio or television reception, which can be determined by tuning the equipment off and on, the user is encouraged to try to correct the interference by one or more of the following measures:

- Reorient or relocate the equipment and/or the receiving antenna.
- Increase the separation between the equipment and receiver.
- Connect the equipment to an AC outlet of a different mains circuit from the mains circuit/outlet providing power to the receiver.
- Consult the dealer or an experienced radio/TV technician for help.

CAUTION

Changes or modifications to this equipment not expressly approved by Creative Labs or Cambridge SoundWorks for compliance will void the user's warranty.

Table of Contents

Introduction and Contents	6
Getting Started.....	7-8
Display Brightness Control.....	9
Radio Operation.....	10-11
iPod Operation	12
X-Fi Processing	13
Quick Reference-Top panel.....	14
Quick Reference-Remote Control.....	15
Quick Reference-Rear Connections	16
Convenience Features	17
Wakeup Functions	18-21
Specification.....	22

Please Note: The contents of this document are subject to change without notice.

Please check www.cambridgesoundworks.com for any available updates to the Owner's Manual, or associated documentation.

INTRODUCTION

The people at Cambridge SoundWorks, division of Creative Technologies, hope you enjoy your new high-performance SoundWorks i525. In addition to bringing your iPod's music library to life, your new music system has great FM stereo sound and plays useful AM band stations. It stores 8 FM station presets along with 8 AM station presets.

The SoundWorks i525 features the X-Fi suite of audio enhancements, which improve your audio enjoyment with a wide range of program sources.

The large display and full-function remote makes i525 operation easy from across the room.

Additional Features

- A dimmer function allows you to choose one of eight different brightness levels.
- The i525 has a built-in energy cell that maintains the current time accurately without AC power for up to ten minutes.
- A side jack allows easy connection of headphones for private listening.
- A convenient MENU / SELECT button lets you adjust Bass, Treble and Snooze time, as well as other adjustable functions.

Contents

- 1) Sound Works i525
- 2) AC to DC Power Supply
- 3) Package of iPod dock inserts to fit a variety of Apple iPod models.
- 4) Infrared Remote Control.

Not Pictured

SoundWorks i525 User Manual
AM Antenna

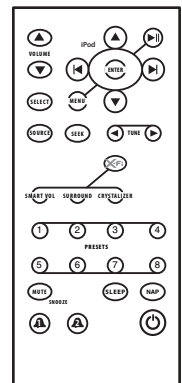
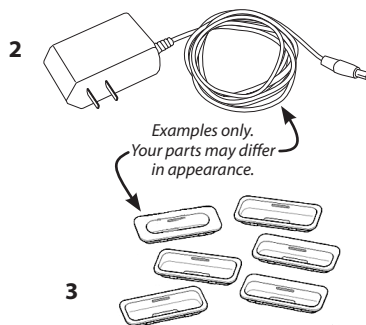
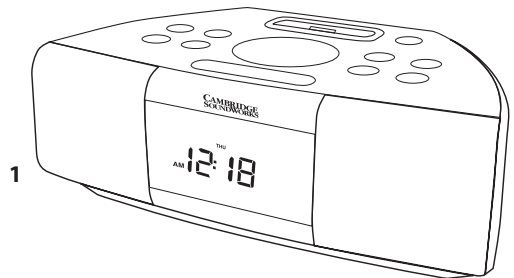

GETTING STARTED

A) Remove the SoundWorks i525 from its protective polybag and place it in your preferred location.

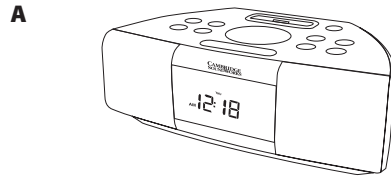

B) On the rear panel, locate the FM wire antenna. Remove the wire tie, then unroll and extend the antenna.

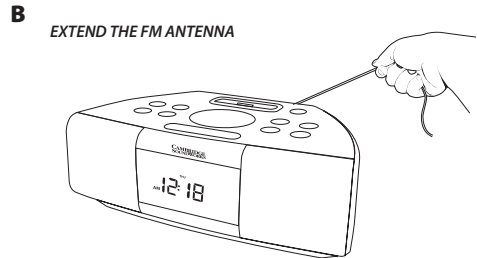

C) Connect the Power Supply to a convenient AC outlet. Then insert the Power Supply DC plug into the **DC POWER INPUT** jack in the rear panel of the i525.

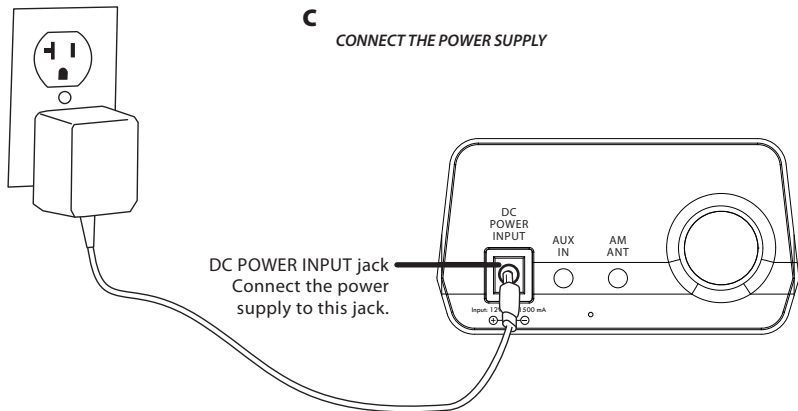

GETTING STARTED (Continued)

Set the Current Time

D) After connecting the i525 to power, it may show "AM 12:00". This indicates the current time needs to be adjusted.

Press and hold **MENU / SELECT** on the top of the i525 for 5 seconds. This will begin the "Time Set" function. Release the button when "12" appears with a blinking ":".

Use the **WHEEL** on the top panel to adjust the current hour. Press **MENU / SELECT**, then use the **WHEEL** again to adjust the current minutes setting. Press **MENU / SELECT**, then use the **WHEEL** again to adjust the day of the week. Press **MENU / SELECT** to store the current time.

Note: The remote control can also adjust the current time. Use the **SELECT** button on the remote control, as you would the **MENU / SELECT** button on the top panel. Use the **VOLUME** up and **VOLUME** down buttons on the remote control, as you would the **WHEEL** on the top panel.

Current Time Maintenance Feature

The i525 features an internal power cell that maintains the clock's accuracy during a short interruption in AC power (up to ten minutes). This device will never need replacement.

This device also lets you move the radio from one site in a residence or office to another site without losing the current time.

Standby and On

E) Pushing the  button chooses Standby or On operation.

D TIME ADJUSTMENT

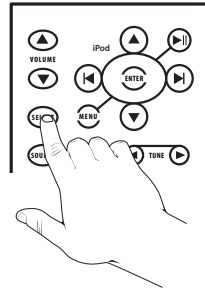
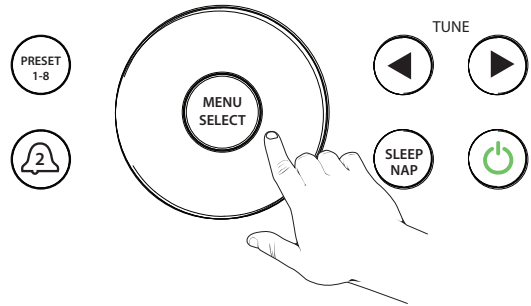

E

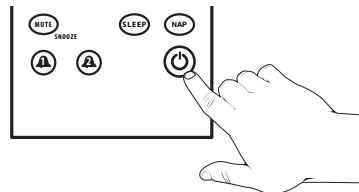
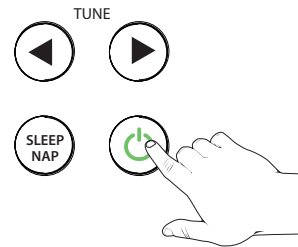

Brightness Function

F) For quick and easy adjustment of the display brightness, from Standby operation, repeatedly tap the **SNOOZE / MUTE** button on the top panel. This will cycle through the available brightness settings.

Once the desired brightness setting is displayed, simply wait for the menu to timeout (about 5 seconds) and the brightness setting is stored.



RADIO OPERATION

Selecting the Radio Bands

A) Press **SOURCE** to select radio operation. The i525 returns to the last radio band and frequency used. Pressing **SOURCE** during radio or AUX operation in the following sequence--FM, AM, AUX, then back to FM.

Note: AUX selection is omitted if there is no plug connected to the AUX input jack on the back panel.

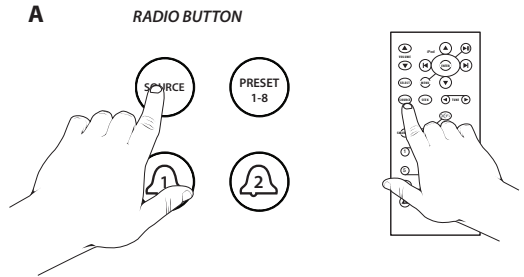

Tuning Stations

B) Auto Tune: Press the **SEEK** button on the remote or press and hold either **TUNE** [◀ and ▶] on the i525 top panel to automatically tune (seek) to the next station.

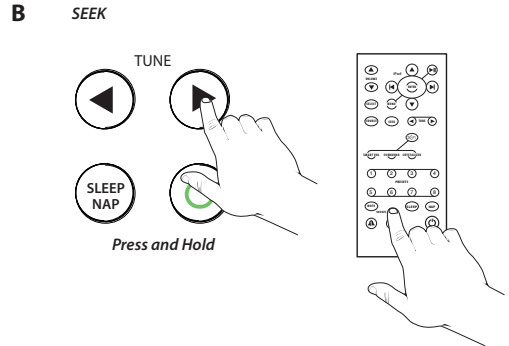

C) Manual Tune: To find a specific frequency, tap a **TUNE** button [◀ and ▶] to advance one frequency increment at a time.

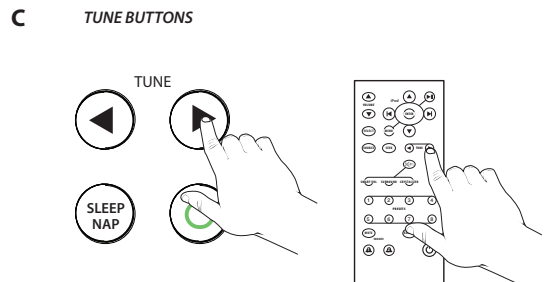

RADIO OPERATION (continued)

Storing Stations in the PRESET Bank

You can store eight FM stations in the i525's PRESET bank while FM is selected and eight AM stations while AM is selected.

A) Storing a radio frequency as a PRESET using the remote control:

Press **SOURCE** to choose the desired radio band (AM or FM).

Tune to the desired station.

Press and hold the target PRESET button on the remote until the preset number is solid on the display.

The station frequency is stored as a Preset.

A PRESET BANK ON THE REMOTE CONTROL

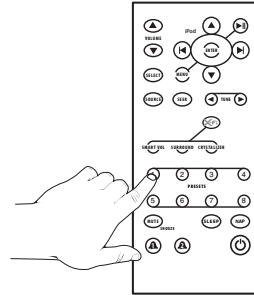

B) Storing a radio frequency as a PRESET using the top panel controls:

Press **SOURCE** to choose the desired radio band (AM or FM).

Tune to the desired station.

Press and hold **PRESET 1-8** on the top panel until the display changes to show Preset numeral 1.

Within five seconds, repeatedly press **PRESET 1-8** until the target PRESET number is shown.

Tap the **MENU SELECT** button.

The station frequency is stored as a Preset.

B PRESET SELECTION FROM THE TOP PANEL

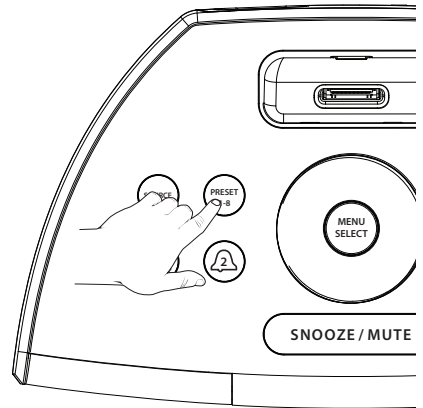

iPod Operation

Using the iPod dock feature of the i525

- 1) There is a selection of inserts included with the i525. These inserts fit various iPod models. Install the insert that best fits your iPod, or use the insert included with your Apple iPod. Make sure the insert snaps into the recess. The top of the insert should be flush with the top of the i525.
- 2) Attach your iPod to the dock connector.
- 3) Select the iPod as a music source by pressing **PLAY / PAUSE** (remote or top panel).
- 4) Use the iPod navigation buttons on the remote control to operate your iPod while it is docked in the i525.

- 1) Install the dock insert that fits your iPod.

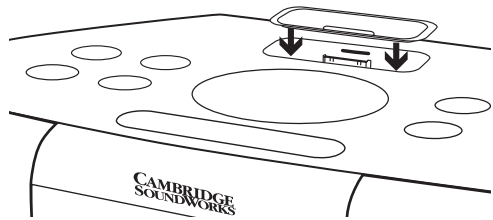

- 2) Connect your iPod.

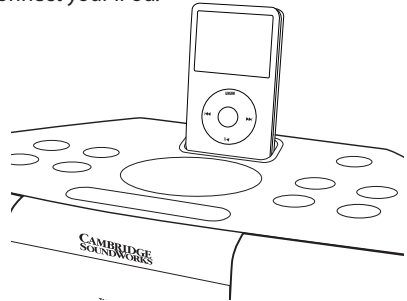

i525 Top Panel

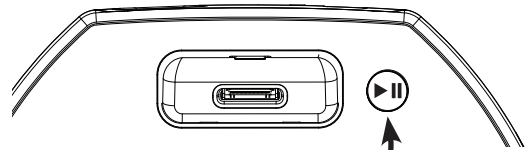

- 3) Select Play / Pause

i525 Remote Control

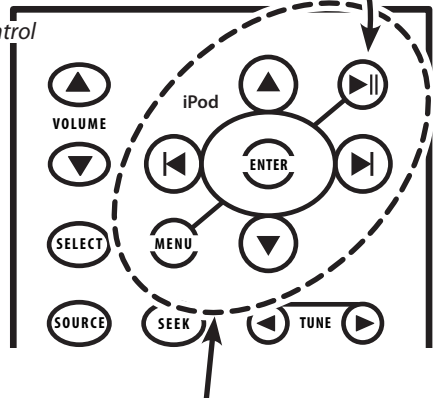

- 4) Use these iPod buttons to operate your iPod.

Notes:

To wake a hibernating iPod, push **PLAY / PAUSE** on the i525 remote control or top panel.

The i525 will not control a connected iPod while the i525 is in **STANDBY**.

The i525 controls iPod functions of a docked iPhone or iPod touch. After docking one of these models, it may be necessary to manually "unlock" and select the iPod function before the i525 remote control can be used.

Creative's X-Fi audio processing technology

Using the X-Fi features of the i525

X-Fi technology on the i525 allows you to combine four different audio enhancements, creating better sound than possible "linear" audio circuitry. The four different X-Fi enhancement choices are:

Crystalizer

Creative Multi-Speaker Surround Virtual - Speakers (SURROUND on remote control)

Creative Multi-Speaker Surround Virtual - Headphones (SURROUND on remote control, when headphones are connected)

Smart Volume Management (SMART VOL on the remote control)

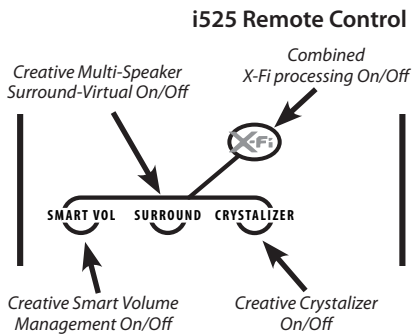

Crystalizer restores the crisp treble and bass punch erased by audio compressor processing employed to create MP3, AAC, and other similar files from the original, higher quality audio file. FM radio and any compressed audio files sound more life-like when Crystalizer is used.

Creative Multi-Speaker Surround Virtual analyzes the audio signal and restores the sonic cues inherent in the original material's wide soundstage. When *X-Fi SURROUND* is chosen on the i525, music seems to fill the width of the room. The i525 disappears as the source of the sound.

Creative Multi-Speaker Surround Virtual-Headphones

improves your headphone experience. Use it whenever the i525 is available and you would normally listen to your iPod on headphones. Select *X-Fi SURROUND* while headphones are connected to the i525 to employ this powerful digital algorithm designed specifically for headphones. With *Creative Multi-Speaker Surround Virtual-Headphones*, music seems to float in front of you, instead of being trapped "between" your ears. This effect greatly enhances any audio program on headphones.

Smart Volume Management is a sophisticated audio engine that eliminates disruptive changes in output from any audio program. It is useful anytime that large volume changes are unwelcome.

a) Use it at night at a low volume when you want to hear all the music but don't want it to get too loud.

b) Use it on radio to "harmonize" the output of different stations, which otherwise may have different overall sound levels.

c) *Smart Volume Management* is also useful if you want to hear music in a noisy environment. With *SVM*, you can set the radio to a level loud enough to overcome the background noise, secure in the knowledge that your music will maintain this consistent output level.

The *CRYSTALIZER*, *SURROUND* and *SMART VOL* audio functions on the remote control can also be combined. For instance, you can combine Crystalizer and Smart Volume Management, Surround with Smart Volume Management, or combine all three. Select which processes you want. Once you have made your choice, you can use the X-Fi button on the remote control to compare enhanced (combined X-Fi processing) with the non-enhanced audio.

QUICK REFERENCE GUIDE - SOUNDWORKS i525 TOP PANEL CONTROLS

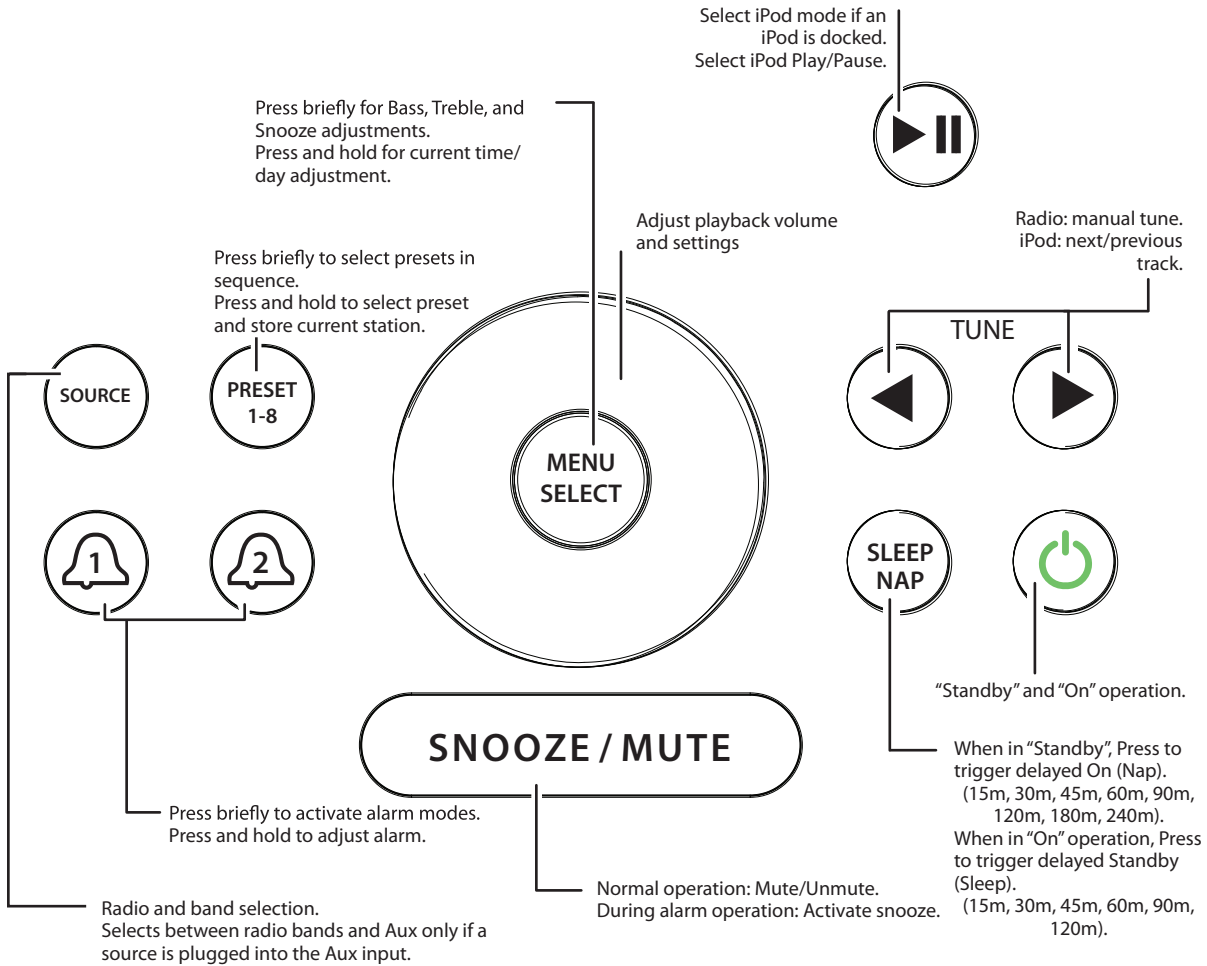

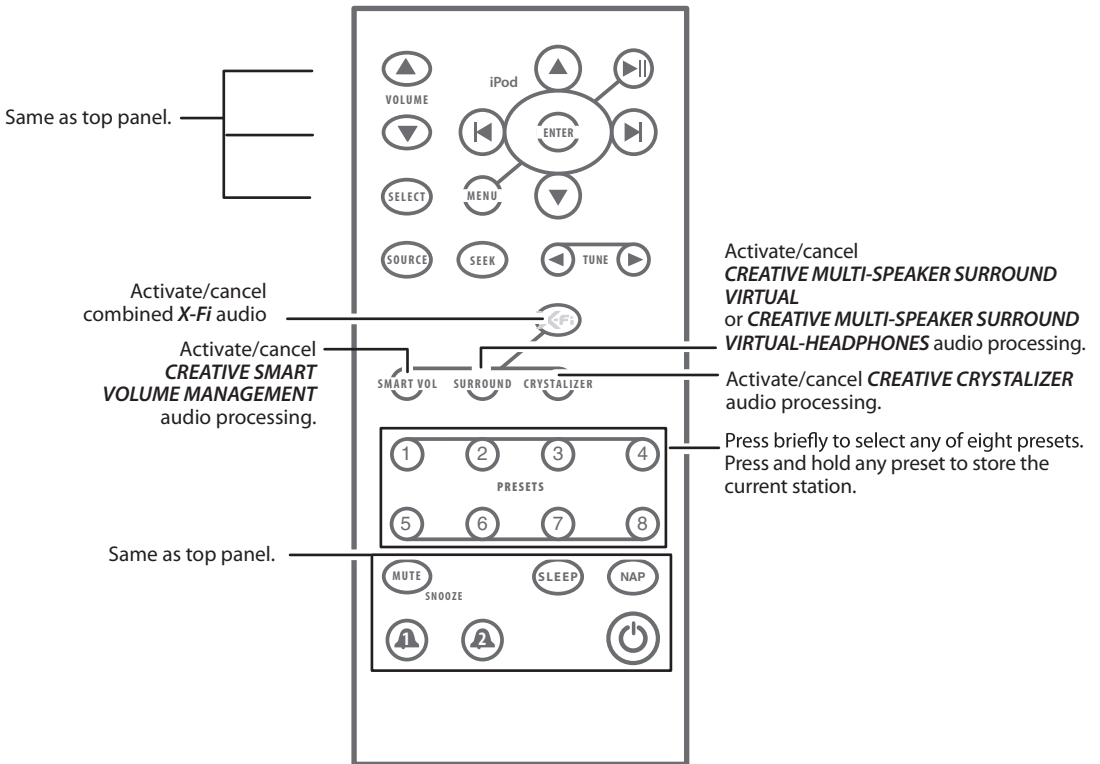
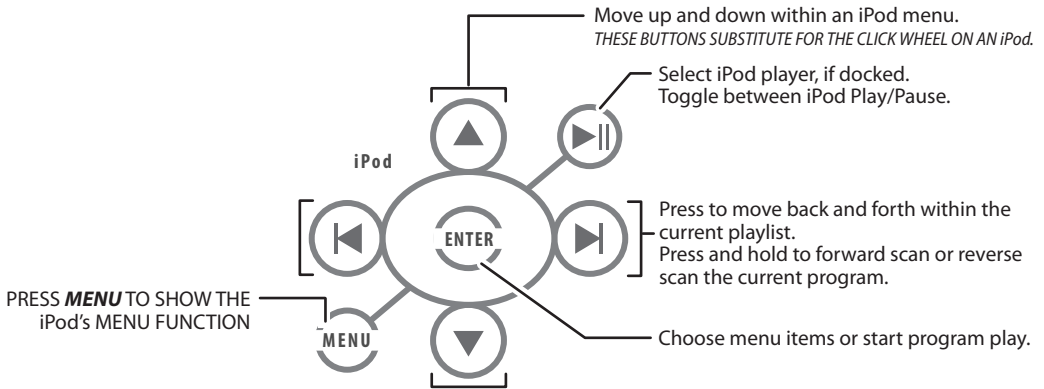

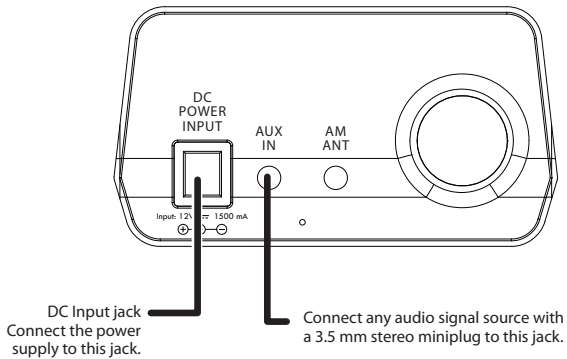

Listening to An External Sound Source

A) If you have an external audio program source (a portable MP3 player, for example), connect it to the AUX IN jack on the rear panel.

B) Press the SOURCE button on the front panel or remote control until the AUX icon appears on the display screen. NOTE: AUX can not be selected if there is no miniplug connected to the AUX IN jack on the rear panel.

CONVENIENCE FEATURES

Mute

A) Press the **SNOOZE/MUTE** bar (top panel) or the **SNOOZE/MUTE** button on the remote control. Mute is cancelled if the **POWER** button is pressed or the volume is adjusted.

Sleep Delay

B) Delayed Turn Off function: While the i525 is "On", press the **SLEEP** button on the remote control or the **SLEEP / NAP** button on the top panel until the desired sleep delay interval is reached.

Sleep delay intervals are 15, 20, 30, 45, 60, 90 and 120 minutes. *Sleep delay* is cancelled if the **POWER** button is pressed.

B) SLEEP DELAY ADJUSTMENT



Nap Feature

C) Use **NAP** for an automatic turn on after a specific period of time. Set the radio or iPod to your desired playback volume. Press the **POWER** button to enter Standby operation. Press the **NAP** button on the remote control or the **SLEEP / NAP** button on the top panel using repeat presses until the desired nap interval is reached.

Nap intervals are 15, 20, 30, 45, 60, 90, 120, 180, and 240 minutes. *Nap* is cancelled if the **POWER** button is pressed.

C) NAP ADJUSTMENT



MENU / SELECT button operation:

D) Press the **MENU / SELECT** button on the top panel or **SELECT** remote control to select the BASS, TREBLE, SNOOZE, X-Fi, and Alarm Day adjustments.

Use the **WHEEL** on the top panel of the i525 or use the **Volume** buttons [▲ and ▼] on the remote control to adjust settings of BASS, TREBLE, SNOOZE, X-Fi, Alarm Days, and Brightness. Any **SELECT** button function stores its current setting and returns the i525 to normal operation after five seconds of inactivity. Pressing other i525 buttons during a **SELECT** button function may cancel **SELECT** button adjustment.

- Bass: Adjustment range is -8 to +8.
- Treble: Adjustment range is -8 to +8.
- Snooze Interval Adjustment is 5 minutes to 30 minutes.
- X-Fi Adjustments are All Off, Crystalizer On, CMSS On, SVM On, and combinations.
- Wakeup day pattern Adjustments are 7 Day, 5 Day, or 2 Day (see next page).
- Brightness Adjustment range is 1 to 8.

SELECT BUTTON ADJUSTMENT

D) BASS ADJUSTMENT

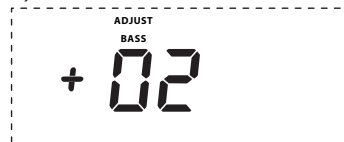

E) TREBLE ADJUSTMENT



F) SNOOZE ADJUSTMENT

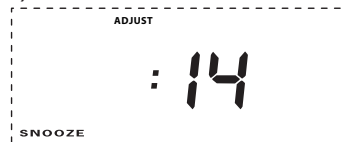

WAKEUP FUNCTIONS

Music Wakeup Features

Each of the two Wakeup Alarms on the i525 will store the following settings:

Wakeup time

Wakeup source (radio frequency, iPod)

Wakeup Volume (for radio or iPod)

X-Fi setting

The Alarm Settings on the i525 are maintained even if the i525 is unplugged.

Tone Wakeup or Music Wakeup

When activating either alarm, the user chooses between *Tone wakeup* and *Music wakeup*. *Tone wakeup* uses an electronic tone to wakeup the user at the stored wakeup time. *Music wakeup* uses the stored settings for source, volume and X-Fi processing.

Storing The Wakeup Settings--Overview

Storing your desired wakeup settings for either Alarm 1 or Alarm 2 involves **two** steps.

First, set the i525 to your desired source, volume and X-Fi setting.

Second, press and hold an Alarm button until you see the display change. Now you can adjust the wakeup hour, the wakeup minutes and the daily wakeup pattern.

At the end of this simple adjustment session, the i525 reminds you of the stored wakeup settings on its display.

After a Tone Wakeup event occurs, the Tone alarm will continue for *ten minutes*. After ten minutes, the alarm will reset itself and the i525 will enter Standby.

After a Music Wakeup event occurs, the Music alarm will continue for one (1) hour. After one hour, the alarm will reset itself and the i525 will enter Standby.

If a second alarm is set to occur during the activation time of the first alarm, the second alarm will override the first alarm. This allows a user to set the Music wakeup for 30 minutes earlier than a Tone wakeup.

Please note: Once the Wakeup settings have been stored, use the i525 any way you wish, with any source. The i525 will wakeup according to the stored wakeup settings.

Wakeup day pattern--7 days a week, 5 days a week (Monday to Friday) and 2 days a week (Saturday and Sunday).

This setting is adjustable in the MENU SELECT button operation discussed on page 17.

DAYS OF WEEK ADJUSTMENT DISPLAY

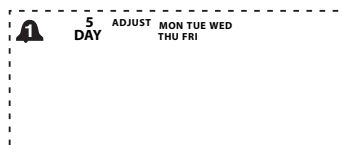

WAKEUP FUNCTIONS (Continued)

Preparing either Alarm 1 or Alarm 2:

PART ONE: PRESELECT THE SOURCE AND VOLUME

- A) Turn the i525 on.
- B) Select a radio station or iPod playback.
- C) Set the Volume.
- D) Adjust X-Fi settings, if desired.
(*Smart Volume Management* is a great choice for Music Wakeup, as it keeps the volume consistent.)

PART TWO: ADJUST THE HOURS AND MINUTES

- A) Press and hold either **ALARM 1** or **ALARM 2**.

The display changes to Hour adjustment.

Use the **TUNE/ADJUST** buttons [◀ and ▶] to adjust the correct wakeup hour.

- B) Press the same Alarm button or **SELECT**.

The display changes to Minutes adjustment.

Use the **TUNE/ADJUST** buttons [◀ and ▶] to adjust the correct wakeup minute.

- C) Press the same Alarm button or **SELECT** to store your alarm preferences.

The display will show, in sequence:

Stored Wakeup Time and Daily Pattern

Stored Wakeup Source (radio frequency or iPod)

Stored Wakeup Volume and Wakeup X-Fi setting.

ALARM ADJUSTMENT DISPLAYS

A) HOUR ADJUSTMENT DISPLAY

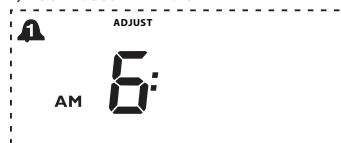

B) MINUTES ADJUSTMENT DISPLAY

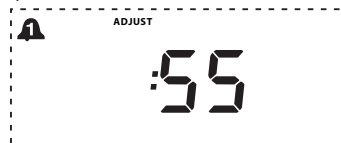

WAKEUP FUNCTIONS (Continued)

Activating/Deactivating Alarms

Press either alarm button to activate or deactivate that alarm. Both alarm buttons follow this sequence:

- Start: Alarm inactive
- First alarm button press: Tone Alarm
- Second alarm button press: Music Alarm
- Third alarm button press: Alarm inactive

Music Alarm occurs only if the i525 is in Standby.
 Tone Alarm occurs if the i525 is in Standby or On.
 Use Tone Wakeup as a reminder function during the day while using the i525 normally.

Activating/Deactivating Alarms

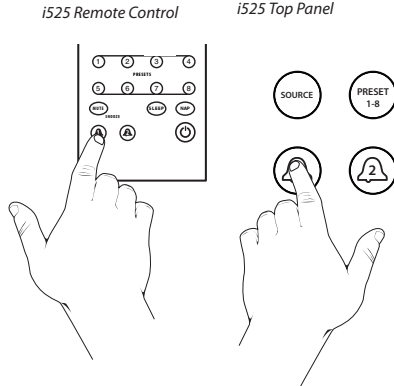

No activated alarms



Alarm 1 set for Tone Wakeup, 7 days a week



Both alarms set for Music Wakeup. Alarm 1 set for 5 days a week, Alarm 2 set for 7 days a week.



Alarm 2 set for Tone Wakeup, 2 days a week



Canceling An Alarm for the Day

To cancel an alarm for the day and reset it for operation the next day, press either Alarm button or the power button. The i525 will enter Standby. The alarm will remain activated and occur on the next day in the designated pattern.

Snooze Function

Tapping the **SNOOZE/MUTE** bar on the i525 or the **SNOOZE/MUTE** button on the remote will silence a Wakeup alarm for nine minutes (default). To change the **SNOOZE** duration, use the **SELECT** and **TUNE/ADJUST** buttons [◀ and ▶] to change the settings (5 minutes to 30 minutes).

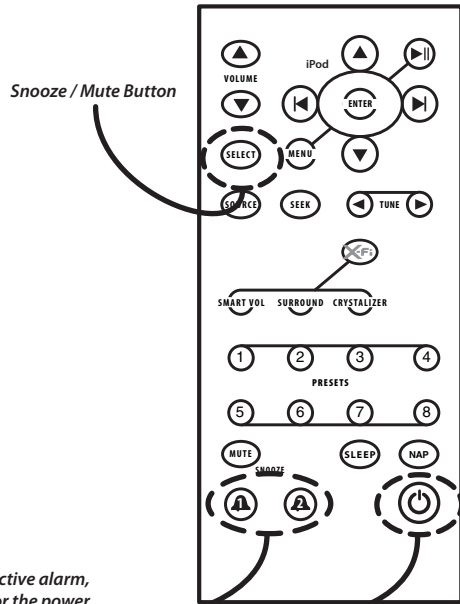

To silence and reset any active alarm, press either alarm button or the power button, on the top panel or the remote.

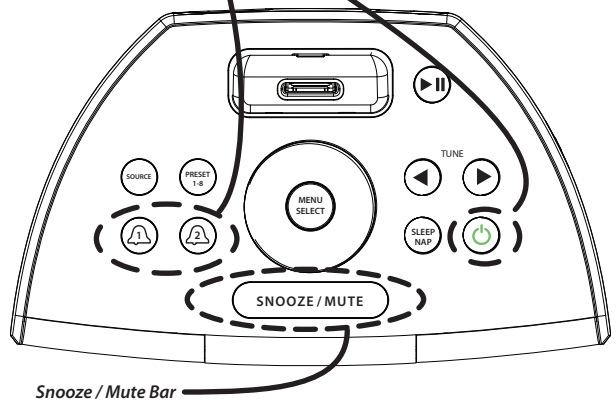

SPECIFICATIONS

Internal audio source

FM stereo/AM tuner (all digital processing of analog RF signals)

Inputs:

Apple iPod Dock on the top panel

Rear panel Aux input (3.5 mm stereo minijack)

Outputs:

One front panel headphone output (3.5 mm stereo minijack)

Dimensions:

Height:	3 3/8 in	86 mm
Width:	10 in	255 mm
Depth:	6 in	153 mm
Weight:	3 lbs	1.4 kg

Power Consumption, maximum:

20 watts

Input voltage:

DC 12V

*Cambridge SoundWorks
120 Water Street
North Andover, MA USA 01845*

*R1, 22 March 2010
P81-2440*