

# Instructions for Installation and Use

Electric built under  
double oven

GB

GB

English, 2

FIU20IX/1  
FIU20WH/1  
FIU20BK/1  
FIMU 23 IX  
FIMU 23 (BK)  
FIMU 23 (WH)

## Contents

Introduction, 2

Safety Information, 3-4

Features, 5

Controls, 6

The electronic programmer, 7

Grill Pan and Handle, 8

Operation when using the Top Oven for Grilling, 9

Using the Top Oven as a Convection Oven, 10

Operation when using the Top Oven as a  
Convection Oven, 11

Using the Main Oven for Fan Cooking, 12

Using the Main Oven for Other Functions, 13

Temperature Conversion Chart, 14

Oven Temperature Chart - Meat, 15

Oven Temperature Charts - Baking, 16

Cooking Results Not Satisfactory, 17

Care and Cleaning, 18-20

Installation, 21-22

If Something Goes Wrong?, 23

If it Still Won't Work/ Disposal of the appliance, 24

Guarantee Information, 25

Service Information, 26

You must read these instructions prior to using  
your appliance and retain them for future use.

# Introduction

GB

Your new appliance is guaranteed\* and will give lasting service. This guarantee is only applicable if the appliance has been installed in accordance with the installation instructions detailed in this booklet. To help make best use of your cooking equipment, please read this booklet carefully. The cooker is designed specifically for domestic use and responsibility will not be accepted for use in any other installation.

**When the cooker is first used an odour may be emitted, this will cease after a period of use.**

When first using the cooker ensure that the room is well ventilated (e.g. open a window or use an extractor fan) and that persons who may be sensitive to the odour avoid any fumes. It is suggested that any pets be removed from the room until the smell has ceased. This odour is due to temporary finish on oven liners and elements and also any moisture absorbed by the insulation.

**\* The guarantee is subject to the provisions that the appliance:**

- (a) Has been used solely in accordance with the Users Instruction Book.**
- (b) Has been properly connected to a suitable supply voltage as stated on the rating plate attached to this equipment.**
- (c) Has not been subjected to misuse or accident or been modified or repaired by any person other than the authorised employee or agent.**
- (d) Has been correctly installed.**



**This appliance conforms with the following European Economic Community directives:**

- 2006/95/EC of 12/12/06 (Low Voltage) and subsequent modifications;
- 2004/108/EC of 15/12/04 (Electromagnetic Compatibility) and subsequent modifications;
- 2009/42/EC of 30/11/09 (Gas) and subsequent modifications (only for models which use gas);
- 93/68/EEC of 22/07/93 and subsequent modifications.
- 2002/96/EC
- 1275/2008 (Stand-by/ Off mode)

---

## Technical Characteristics

---

### Top Oven

Usable Volume: 32 Litres

#### ENERGY LABEL - Top Oven

Directive 2002/40/EC on the label of electric ovens  
Norm EN 50304

Declared energy consumption for  
Natural convection Class

heating mode: Conventional

### Main Oven

Usable Volume: 54 Litres

#### ENERGY LABEL - Main Oven

Directive 2002/40/EC on the label of electric ovens  
Norm EN 50304

Declared energy consumption for  
Natural convection Class

heating mode: Fan Oven

### Voltage and Frequency

230-240V~ 50Hz

- **WARNING:** The appliance and its accessible parts become hot during use.
- Care should be taken to avoid touching heating elements.
- Children less than 8 years of age shall be kept away unless continuously supervised.
- This appliance can be used by children aged from 8 years and above and persons with reduced physical, sensory or mental capabilities or lack of experience and knowledge if they have been given supervision or instruction concerning use of the appliance in a safe way and understand the hazards involved. Children shall not play with the appliance. Cleaning and user maintenance shall not be made by children without supervision
- During use the appliance becomes hot. Care should be taken to avoid touching heating elements inside the oven.
- **WARNING:** Accessible parts may become hot during use. Young children should be kept away.
- Do not use harsh abrasive cleaners or sharp metal scrapers to clean the oven door glass since they can scratch the surface, which may result in shattering of the glass
- When cleaning the appliance do not use steam cleaner.
- **WARNING:** Ensure that the appliance is switched off before replacing the lamp to avoid the possibility of electric shock
- The appliance is not intended to be operated by means of an external timer or separate remote-control system.

# For Your Safety

GB

**When used properly your appliance is completely safe but as with any electrical product there are certain precautions that must be observed. PLEASE READ THE PRECAUTIONS BELOW BEFORE USING YOUR APPLIANCE.**

## Always

- Always make sure you remove all packaging and literature from inside the oven and grill compartments before switching on for the first time.
- Always make sure you understand the controls prior to using the appliance.
- Always keep children away from the appliance when in use as the surfaces will get extremely hot during and after cooking.
- Always make sure all controls are turned off when you have finished cooking and when not in use.
- Always stand back when opening an oven door to allow any build up of steam or heat to disperse.
- Always use dry, good quality oven gloves when removing items from the oven/grill.
- Always take care to avoid heat/steam burns when operating the controls.
- Always turn off the electricity supply at the wall switch before cleaning and allow the appliance to cool.
- Always make sure the shelves are in the correct position before switching on the oven.
- Always keep the oven and grill doors closed when the appliance is not in use.
- Always take care when removing utensils from the top oven when the main oven is in use as the contents may be hot.
- Always keep the appliance clean as a build up of grease or fat from cooking can cause a fire.
- Always follow the basic principles of food handling and hygiene to prevent the possibility of bacterial growth.
- Always keep ventilation slots clear of obstructions.
- Always refer servicing to a qualified appliance service engineer.
- During use the oven becomes hot. Care should be taken to avoid touching heating elements inside the oven.

## SAFETY ADVICE

### IN THE EVENT OF A CHIP PAN OR ANY OTHER PAN FIRE:

1. TURN OFF THE COOKER APPLIANCE AT THE WALL SWITCH.
2. COVER THE PAN WITH A FIRE BLANKET OR DAMP CLOTH, this will smother the flames and extinguish the fire.

3. LEAVE THE PAN TO COOL FOR AT LEAST 60 MINUTES BEFORE MOVING IT. Injuries are often caused by picking up a hot pan and rushing outside with it. NEVER USE A FIRE EXTINGUISHER TO PUT OUT A PAN FIRE as the force of the extinguisher is likely to tip the pan over. Never use water to extinguish oil or fat fires.

## Never

- Never leave children unsupervised where a cooking appliance is installed as all cooking surfaces will be hot during and after use.
- Never allow anyone to sit or stand on any part of the appliance.
- Never store items above the appliance that children may attempt to reach.
- Never remove the oven shelves whilst the oven is hot.
- Never heat up unopened food containers as pressure can build up causing the container to burst.
- Never store chemicals, food stuffs or pressurised containers in or on the appliance, or in cabinets immediately above or next to the appliance.
- Never operate the grill with the door closed as this will cause the appliance to overheat.
- Never use the appliance as a room heater.
- Never use the grill to warm plates.
- Never dry any items on the oven doors.
- Never install the appliance next to curtains or other soft furnishings.
- Never allow children to play with the appliance controls.
- Never use 'steam cleaners'.

Children should be supervised to ensure that they do not play with the appliance.

! The appliance should not be operated by people (including children) with reduced physical, sensory or mental capacities, by inexperienced individuals or by anyone who is not familiar with the product. These individuals should, at the very least, be supervised by someone who assumes responsibility for their safety or receive preliminary instructions relating to the operation of the appliance.

! **The appliance must be used by adults only for the preparation of food, in accordance with the instructions outlined in this booklet. Any other use of the appliance (e.g. for heating the room) constitutes improper use and is dangerous. The manufacturer may not be held liable for any damage resulting from improper, incorrect and unreasonable use of the appliance.**

**WARNING: DO NOT TOUCH THE GLASS DOORS WHEN THE OVEN IS IN USE AS THESE AREAS CAN BECOME HOT.**

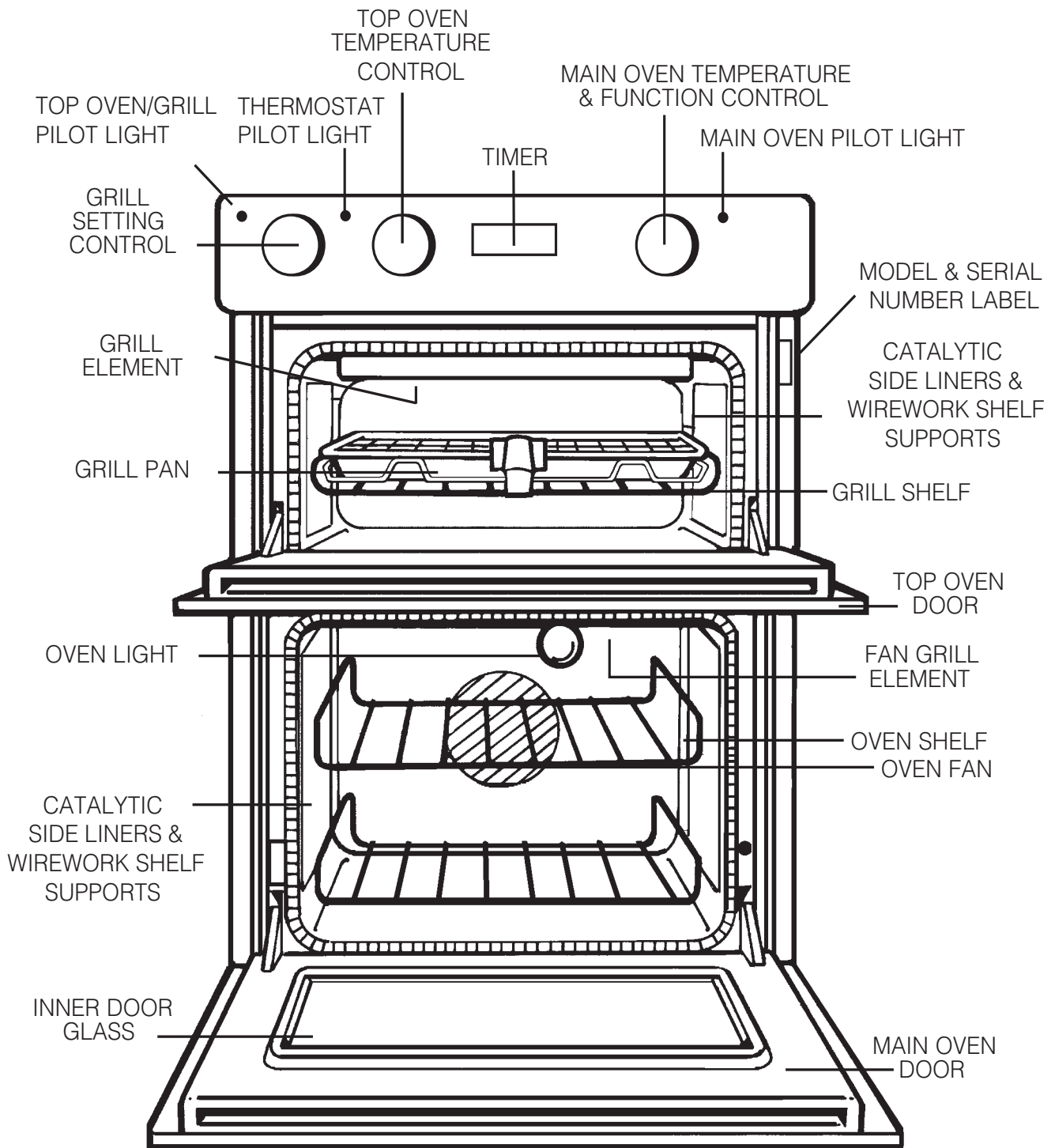



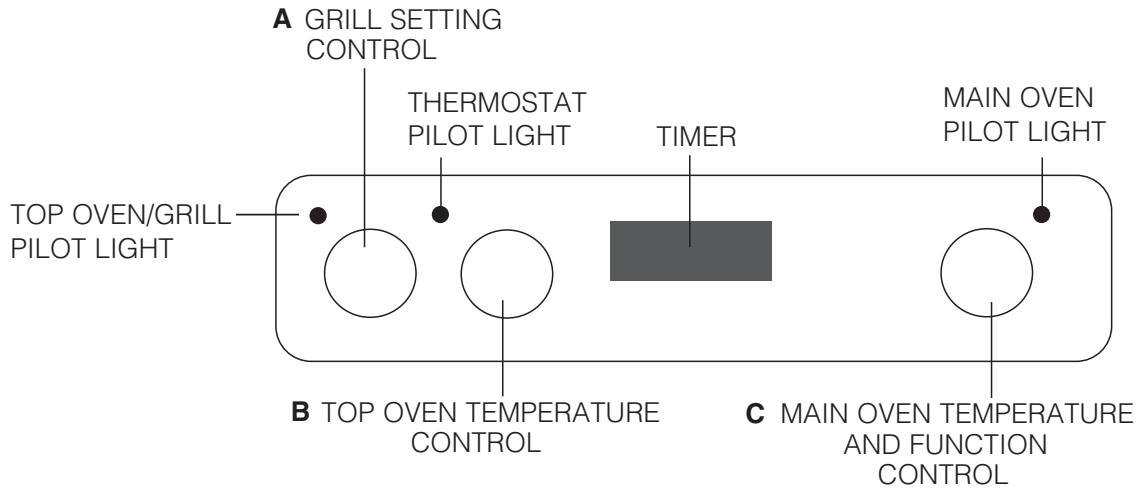

**NEVER** line the shelves, floor or sides of the oven or grill with aluminium foil as overheating and damage may result.

# Controls

GB



Control Knob	Description	Function
A	Grill Setting Control	Selects the heat at which the grill will cook the food. <b>min - max Grill Control Settings:</b> <b>Min = Low, Max = High</b>
B	Top Oven Temperature Control	 Selects the cooking temperature (Degrees Centigrade) when using the top oven as a conventional oven.
C	Main Oven Temperature & Function Control	 <b>Fan Only Setting</b> - This is used to decrease the amount of time required to defrost food items.   <b>Oven Light Only</b> - Switches on the Main Oven Interior Light Only   <b>Main Oven Temperature Scale (In Degrees Centigrade).</b> - When cooking select the required cooking temperature.

## Cooling Fan

A gentle flow of air will be blown below the control panel when the grill control is used and after a short period of time when the ovens are used.

**Note:** Whenever the appliance has been used, the cooling fan may run on or restart itself after all the controls have been turned off. This indicates that the appliance is still warm.

## Main Oven Interior Light

The oven lights are operated when their respective oven control is used.

The main oven has a light only position.

**Note: It is advisable to check that all oven controls have been switched off when you have finished using the appliance.**

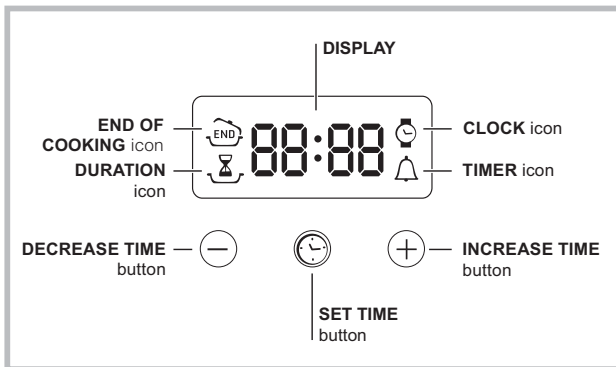



! The Main Oven (only) can be controlled by the automatic timer.

! Never operate the grill or top oven when the main oven is set to cook automatically because the oven cavity can become warm and this may cause bacterial growth in food.

## Setting the clock



! The clock may be set when the oven is switched off or when it is switched on, provided that the end time of a cooking cycle has not been programmed previously. After the appliance has been connected to the mains,

or after a blackout, the  icon and the four numerical digits on the DISPLAY will begin to flash.

1. Press the  button several times until the  icon and the four digits on the display begin to flash.
2. Use the "+" and "-" buttons to adjust the time; if you press and hold either button, the display will scroll through the values more quickly, making it quicker and easier to set the desired value.
3. Wait for 10 seconds or press the  button again to finalise the setting.

## Setting the timer

! This function does not interrupt cooking and does not affect the oven; it is simply used to activate the buzzer when the set amount of time has elapsed.



1. Press the  button several times until the  icon and the three digits on the display begin to flash.
2. Use the "+" and "-" buttons to set the desired time; if you press and hold either button, the display will scroll through the values more quickly, making it quicker and easier to set the value.
3. Wait for 10 seconds or press the  button again to finalise the setting.

The display will then show the time as it counts down. When this period of time has elapsed the buzzer will be activated.

## Programming cooking





! A cooking mode must be selected before programming can take place.

### Programming the cooking duration

1. Press the  button several times until the  icon and the three digits on the DISPLAY begin to flash.
2. Use the "+" and "-" buttons to set the desired duration; if you press and hold either button, the display will scroll through the values more quickly, making it quicker and easier to set the value.
3. Wait for 10 seconds or press the  button again to finalise the setting.
4. When the set time has elapsed, the text END appears on the DISPLAY, the oven will stop cooking and a buzzer sounds. Press any button to stop the buzzer and turn all control knobs to the 0 position.
  - For example: it is 9:00 a.m. and a time of 1 hour and 15 minutes is programmed. The programme will stop automatically at 10:15 a.m.

### Setting the end time for a cooking mode

! A cooking duration must be set before the cooking end time can be scheduled.

1. Follow steps 1 to 3 to set the duration as detailed above.
2. Next, press the  button until the  icon and the four digits on the DISPLAY begin to flash.
3. Use the "+" and "-" buttons to adjust the cooking end time; if you press and hold either button, the display will scroll through the values more quickly, making it quicker and easier to set the desired value.
4. Wait for 10 seconds or press the  button again to finalise the setting.
5. When the set time has elapsed, the text END appears on the DISPLAY, the oven will stop cooking and a buzzer sounds. Press any button to stop it. Programming has been set when the  and  buttons are illuminated. The DISPLAY shows the cooking end time and the cooking duration alternately.
  - For example: It is 9:00 a.m. and a duration of 1 hour has been programmed. 12:30 is scheduled as the end time. The programme will start automatically at 11:30 a.m.

### Cancelling a programme

To cancel a programme:

- press the  button until the icon corresponding to the setting you wish to cancel and the digits on the display are flashing. Press the "-" button until the digits 00:00 appear on the display.
- Press and hold the "+" and "-" buttons; this will cancel all the settings selected previously, including timer settings.



# Grill Pan and Handle

GB

## Using the grill pan kit

The grill pan handle is detachable from the pan to facilitate cleaning and storage. Fix the pan handle securely before use:

1. Fit the handle to the grill pan so that the external 'hooks' embrace the edge of the pan (fig. 1)
2. Make sure that the middle part of the handle fits exactly the protruding support of the pan (fig. 2) and holds the pan from the bottom.

The food must be placed on the rack in the grill pan. Position the grill pan on top of the oven rack. The best results are achieved by placing the oven rack on the uppermost shelves. Pouring a little water into the grill pan will make the collection of grease particles more efficient and prevent the formation of smoke.

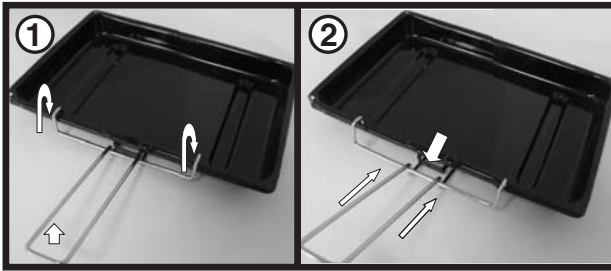

## Grill Pan, Food Support

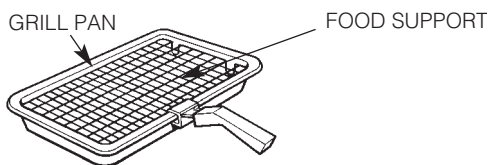

## Top Oven Shelf Positioning for Grilling

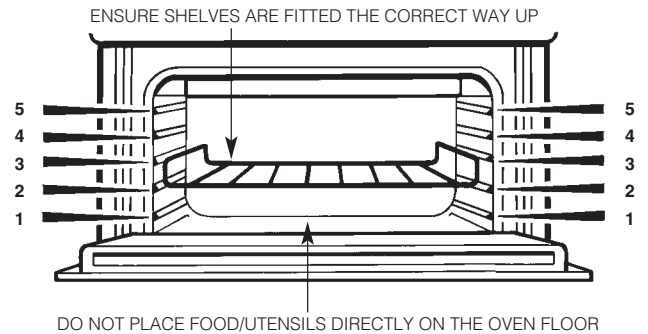

### NOTE:

- Preheat the grill if indicated on grill chart.
- The grill pan must be placed on the correct shelf and positioned centrally under the grill element.
- Leave the control at MAX for toast, and for fast cooking of foods.
- For thicker foods requiring longer cooking, turn the switch to a lower setting after the initial sealing on both sides at MAX. The thicker the food, the lower the control should be set.
- DO NOT line the grill pan with aluminium foil, as this increases the amount of fat spitting which can cause a fire.
- After use always return the grill control to the OFF (0) position.



# Operation when using the Top Oven for Grilling

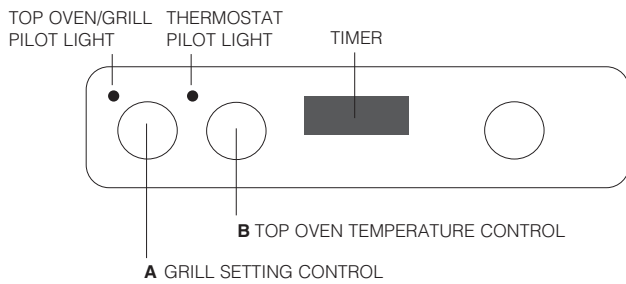

## Grill Control Example:

**MAX** = Maximum Grill Setting.

**NOTE:** Do not grill with the grill/top oven door closed.

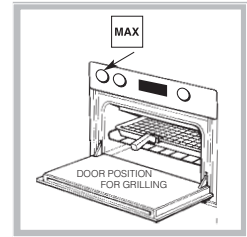

**Step 3** After use, turn the grill control (A) to the off position (•).

**Step 1** Place the oven shelf in the correct position (see Grilling Guide). Locate the grill pan on the oven shelf, centrally under the grill element. Leave the door fully open.

**! The Top oven/Grill Pilot Light is on when grill is used.**

**Step 2** Turn knob (A) clockwise for FULL grill or anti-clockwise for HALF grill, to select the Grill Setting (min-max): (MIN = Low, MAX = High)

**! Ensure knob (B) is in "0 position". The grill and the top oven cannot work simultaneously**

**DO NOT allow young children near to the appliance when the grill is in use as the surfaces get extremely hot.**

## GUIDE TO GRILLING

FODD	PREHEAT FOR ONE MINUTE	SHELF POSITION FROM THE BASE OF THE OVEN	SETTING	APPROXIMATE COOKING TIME	PAN TO BE USED
Toasting of Bread Products	Setting MAX	5	Setting MAX	5 - 10 minutes	Grill pan and food support
Small cuts of meat, Sausage, Bacon	Setting MAX	4 or 5	Setting MAX for 5-8 minutes then reduce to lower setting	10 - 25 minutes	Grill pan and food support
Chops etc. Gammon steaks	Setting MAX	4	Setting MAX for 10 minutes then reduce to lower setting	20 - 35 minutes	Grill pan and food support
Fish: Whole Fillets Fingers	Setting MAX	3 4 or 5 4 or 5	Setting MAX	8 - 12 minutes 10 - 15 minutes 10 - 20 minutes	Grill pan and food support
Pre-cooked potato products	Setting MAX	4 or 5	Setting MAX or lower setting	15 - 20 minutes	Grill pan and food support
Pizzas	Setting MAX	3 or 4	Setting MAX or lower setting	10 - 20 minutes	Grill pan and food support
Browning of food eg. Cauliflower Cheese	Setting MAX	3 or 4	Setting MAX	10 - 20 minutes	Dish placed directly on the shelf

# Using the Top Oven as a Convection Oven

GB

The top oven should be used to cook small quantities of food. The oven is designed so that the grill element operates at a reduced heat output, this is combined with a heating element situated underneath the floor of the oven. To ensure even cooking of the food it is important that cooking utensils are positioned correctly on the oven shelf so that the element is directly above. As a guide, the front of the utensil should be approx. 100mm (4") from the front of the shelf.

## Important

**Always** remove the grill pan handle from the grill pan, when the pan is being used for oven cooking.

**Always** use oven gloves when basting, turning or removing food from the oven.

**Note: Charts are a guide only, to suit personal taste and requirements, it may be necessary to increase or decrease temperatures by 10°C. It may also be necessary to increase or decrease cooking times.**

## SHELF POSITIONING

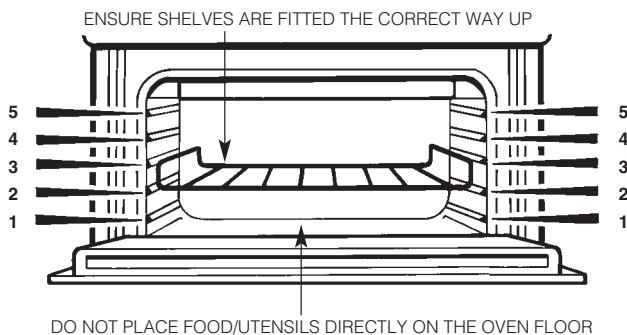

There should always be at least 25mm (1 inch) between the top of the food and the grill element.

**WARNING: Items stored in the top oven will get hot when the main oven is in use.**

**DO NOT** allow young children near to the appliance when the top oven is in use as the surfaces get extremely hot.

# Operation when using the Top Oven as a Convection Oven

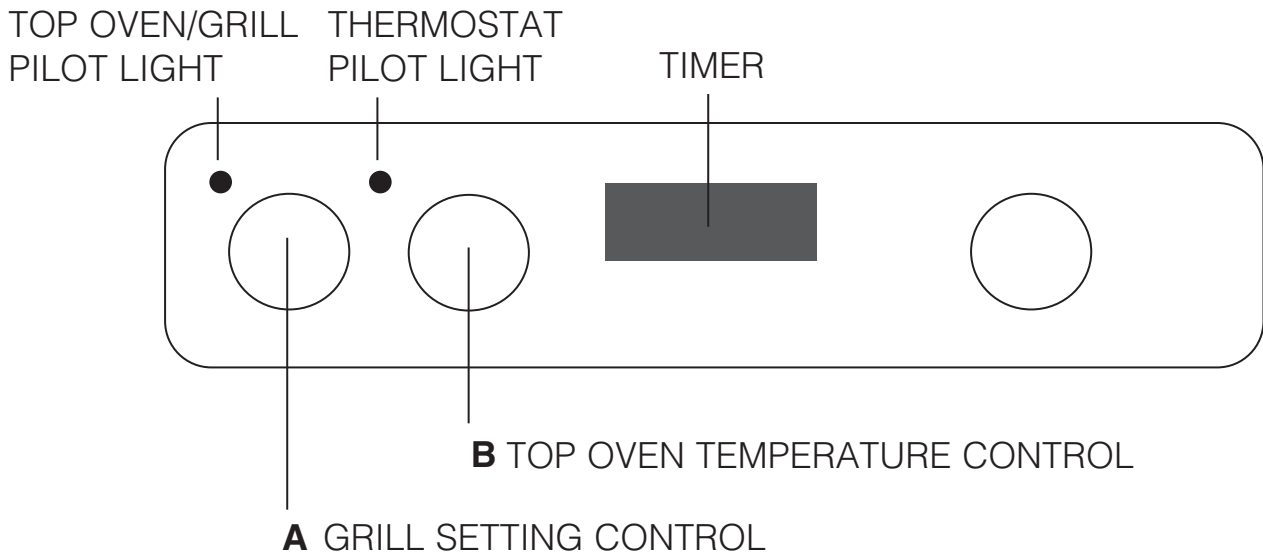

- Step 1** Place the shelf in the correct position (see Oven Temperature Charts).
- Step 2** Select the required cooking temperature (100-220°C) using control (B) (see Top Oven Temperature Charts). The pilot light will immediately come on, and remain on until the oven reaches the required temperature. The light will then automatically go off and on during cooking as the oven thermostat maintains the correct temperature.
- Step 3** Place the food centrally on the shelf below the element ensuring the oven door is closed.

**! The Top oven/Grill Pilot Light is lit when grill is used.**

**NOTE: At the end of your cooking, always return control (B) to the OFF (O) position.**

## PLATE WARMING

Place the plates/dishes on shelf position 1 from the base of the top oven, and turn top oven temperature control (B) to 100°C for 10-15 minutes.

**Never use the grill setting control (A) when warming plates.**

## TOP OVEN UTENSILS

Do Not use: Meat Pans and Baking Trays larger than - 225mm x 300mm (9"x12")

**DO NOT use the grill pan or main oven meat pan as a meat pan in the top oven, as the air circulation will be seriously restricted.**

# Using the Main Oven for Fan Cooking

GB

Since a circulaire fan oven heats up more quickly and generally cooks food at a lower temperature than a conventional oven, pre-heating is often unnecessary. For guides on "pre-heating", "cooking temperatures" and "cooking times" see "Oven Temperature Charts" later in book.

**Note: Charts are a guide only, to suit personal taste and requirements, it may be necessary to increase or decrease temperatures by 10°C. It may also be necessary to increase or decrease cooking times.**

## MAIN OVEN SHELF POSITIONING FOR FAN OVEN

Most foods will cook satisfactorily on any shelf position, due to even distribution of heat in the main oven, but the shelves must be evenly spaced.

The top oven rod shelf can be used in the main oven when cooking large quantities of food. (N.B. Maximum 2 shelves in the main oven).

## MAIN FAN OVEN OPERATION

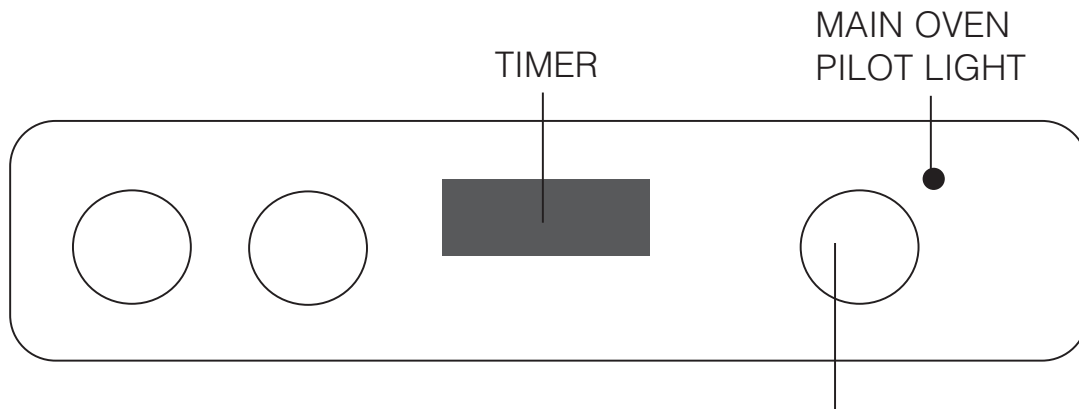

- Step 1** Check that the timer is in manual.
- Step 2** Place the shelf/shelves in the correct position (see Main Oven Temperature Charts).
- Step 3** Place the food centrally on the shelf ensuring the oven door is fully closed.
- Step 4** Select the required cooking temperature (80°C - MAX) by turning control (C) clockwise. The pilot light (•) will immediately come on, and remain on until the oven reaches the required temperature. The light will then automatically go off and on during cooking as the oven thermostat maintains the correct temperature.

**Food or utensils should never be placed directly on the floor of the oven for cooking.**

**DO NOT allow young children near to the appliance when the main oven is in use as the surfaces get extremely hot.**

## MAIN OVEN UTENSILS

DO NOT Use:

- Meat Pans larger than-375mm x 300mm (15"x12")
- Baking Trays larger than-325mm x 250mm (13"x10")

## TEMPERATURE & TIME

When two shelves are in use to cook large quantities of food, it may be necessary to increase the cooking times given in the temperature charts by a few minutes, to allow for the loss of heat due to extra time taken to load the oven, and the larger mass of food. Baking trays should have an even gap around the oven.

## C MAIN OVEN TEMPERATURE AND FUNCTION CONTROL

**Note: When you have finished using your cooker, always return the controls to their OFF position (O). At the end of the cooking period there may be a momentary puff of steam when the door is opened. This will disperse in a few seconds and is a perfectly normal characteristic of an oven with a good door seal.**

# Using the Main Oven for Other Functions



## FAN ONLY SETTING

### DEFROSTING FROZEN MEAT & POULTRY

Joints of meat and whole birds should be defrosted slowly, preferably in a refrigerator (allowing 5-6 hours per lb.) or at room temperature (allowing 2-3 hours per lb.). Frozen meat or poultry must be completely defrosted before cooking in the oven. However, to decrease the amount of time required to defrost food items, a nonheating fan only setting may be selected for the main oven only.

#### OPERATION: TO ASSIST IN DEFROSTING:

Place food in the oven and close the oven door. Turn the Multifunction Control (D) clockwise to the  setting:

This defrosts by circulating the air around the food, time to defrost will depend on type and size of the food.

**NOTES: DO NOT defrost meat and poultry by warming the food through.**

Foods ideally suited to defrosting using the fan only setting are cream/cream cakes, butter cream filled cakes, gateaux, cheese cakes, iced cakes, quiches, pastries, biscuits, bread, croissants, fruit and many delicate frozen foods.

If fish, meat and poultry are to be defrosted using the fan only setting, where possible it is recommended that the food should be small and thin.

The items should be placed so that the maximum amount of surface area is exposed to the circulating air, and that they are turned regularly to ensure even defrosting.

Larger cuts of meat and poultry may be defrosted by using the fan only setting up to a maximum weight of 2 kg (4lb 8oz).

It is important to wash both meat and poultry and cooking utensils immediately after defrosting and before cooking. Food should be cooked immediately after defrosting.

**It is very important to strictly adhere to the basic principles of food handling and hygiene to prevent the possibility of bacterial growth.**



## LIGHT ONLY SETTING

When the Multifunction Control (D) is turned clockwise to the  setting, the main oven light only will illuminate:

# Temperature Conversion Chart

GB

The chart below gives details of comparisons of oven settings for gas conventional ovens and fan oven in degrees °F and °C

Gas Mark	Conventional Oven		Fan Oven
	°F	°C	°C
½	250	120	100
1	275	140	120
2	300	150	130
3	325	160	140
4	350	180	160
5	375	190	170
6	400	200	180
7	425	220	200
8	450	230	210
9	475	240	220

# Oven Temperature Chart - Meat

Food	Main Fan Oven Cooking		
	Note: Up to two shelves may be used in this oven. The position of these is not important providing they are evenly spaced.		
Meat	Pre-heat	Temperature °C	Time (approx.)
Beef	No	160/180	20-25 mins per 450g (1lb) + 20 mins extra.
Lamb	No	160/180	25 mins per 450g (1lb) + 25 mins extra.
Pork	No	160/180	25 mins per 450g (1lb) + 25 mins extra.
Veal	No	160/170	25-30 mins per 450g (1lb) + 25 mins extra
Chicken/Turkey up to 4kg (8lb)	No	160/180	18-20 mins per 450g (1lb) + 20 mins extra.
Turkey up to 5.5kg (12lb)	No	150/160	13-15 mins per 450g (1lb) e.g. 5kg (11lb) = 143-165 mins
Turkey over 5.5kg (12lb)	No	150	12 mins per 450g (1lb) e.g. 10kg (22lb) = 264 mins
Casserole Cooking	No	140/150	1½ - 2 hrs

Food	Top Oven Convection Cooking			
	Pre-heat	Temperature °C	Time (approx.)	Position From Base of Oven
Beef/ Lamb (Slow Roasting)	Yes	170/180	35 mins per 450g (1lb) + 35 mins over	1
Beef/ Lamb (Foil Covered)	Yes	190/200	35 mins per 450g (1lb)	1
Pork (Slow Roasting)	Yes	170/180	40 mins per 450g (1lb) + 40 mins over	1
Pork (Foil Covered)	Yes	190/200	40 mins per 450g (1lb)	1
Veal (Slow Roasting)	Yes	170/180	40-45 mins per 450g (1lb) + 40 mins over	1
Veal (Foil Covered)	Yes	190/200	40-45 mins per 450g (1lb)	1
Poultry/Game (Slow Roasting)	Yes	170/180	25-30 mins per 450g (1lb) + 25 mins over	1
Poultry/Game (Foil Covered)	Yes	190/200	25-30 mins per 450g (1lb)	1
Casserole Cooking	Yes	150	2-2½ hrs	1

## COOKING MEAT/POULTRY IN THE TOP OVEN

Small joints of meat up to 1.5Kg (3 lbs) and poultry up to 3.6Kg (8lbs) can be roasted in a small meat pan in the top oven.

### IF USING ALUMINIUM FOIL

**1. Never allow foil to touch sides of oven. 2. Never cover interior with foil. 3. Never cover shelves with foil.**

The most accurate method of testing the readiness of joints of meat or whole poultry is to insert a meat thermometer into the thickest part of a joint of meat, or the thickest part of poultry thighs, during the cooking period. The meat thermometer will indicate when the required internal temperature has been reached.

Beef			Pork	Lamb	Poultry
Rare 60°C	Medium 70°C	Well Done 75°C	90°C	80°C	90°C



# Oven Temperature Charts - Baking

GB

Baking	Main Fan Oven Cooking		
	Note: Up to two shelves may be used in this oven. The position of these is not important providing they are evenly spaced.		
Food	Pre-heat	Temperature °C	Time in mins.
Scones	Yes	210/220	10-15 mins
Small Cakes	No	170/180	20-25 mins approx
Victoria Sandwich	No	160/170	20-30 mins
Sponge Sandwich (Fatless)	Yes	180/190	15-20 mins
Swiss Roll	Yes	190/200	10-15 mins
Semi-rich Fruit cakes	No	140/150	60-75 mins
Rich Fruit Cakes	No	130/140	Depending on size
Shortcrust Pastry	No	190/200	Depending on use
Puff Pastry	No	190/200	Depending on use
Yorkshire Pudding	Yes	180/190	30-45 mins
Individual Yorkshire Pudding	Yes	190/200	20-45 mins
Milk Pudding	No	130/140	90-120 mins
Baked Custard	No	140/150	35-45 mins
Bread	Yes	200/210	20-30 mins
Meringues	No	90	180-240 mins

Baking	Top Oven Convection Cooking			
	Pre-heat	Temperature °C	Time in mins.	Position from Base of Oven
Scones	Yes	210/220	10-15 mins	3
Small Cakes	Yes	180/190	20-25 mins	3
Victoria Sandwich	Yes	170/180	20-30 mins	3
Sponge Sandwich (Fatless)	Yes	180/190	20-25 mins	3
Swiss Roll	Yes	200/210	10-15 mins	3
Semi-rich Fruit cakes	Yes	150/160	7 inch 60-75 mins	2
Rich Fruit Cakes	Yes	140/150	Depending on size	2
Shortcrust Pastry	Yes	190/200	Depending on recipe	3
Puff Pastry	Yes	200/210	Depending on recipe	2
Yorkshire Pudding	Yes	190/200	30-40 mins	1 or 2
Individual Yorkshire Pudding	Yes	200/210	20-30 mins	1 or 2
Milk Pudding	Yes	140/150	90-120 mins	3
Baked Custard	Yes	150/160	40-50 mins	2
Bread	Yes	200/210	30-40 mins	1 or 2
Meringues	Yes	100	150-180 mins	3

**Note: If soft tub margarine is being used for cake making, we would recommend using the all in one method and to reduce the temperature by 10°C. Temperatures recommended in this chart refer to cakes made with block margarine or butter only.**

# Cooking Results Not Satisfactory

## GRILL

### Uneven cooking front to back

Ensure that the grill pan is positioned centrally below the grill element.

### Fat splattering

Ensure that the grill pan is not lined with foil. Ensure that the grill setting control (A) is not set too high.

## BAKING GENERAL

### Uneven rising of cakes

Ensure that the oven shelves are level.

### Sinking of cakes

The following may cause cakes to sink:

1. Pre-heating of fan ovens - not always necessary.
2. Cooking at too high a temperature - reduce standard temperatures by 25°C for fan ovens.
3. Using normal creaming method with a soft margarine. If using soft margarine, use an all in one method instead of the traditional creaming of the margarine and sugar. Remember when using a food mixer or processor not to over-cream soft margarine.

### Over/undercooking

Refer to the cooking times and temperatures given in the Oven Temperature Charts provided, however, it may be necessary to increase or decrease temperatures by 10°C to suit personal taste.

Do not use utensils greater than 56mm (2¼") in height for roasting.

## TOP OVEN BAKING

### Uneven cooking front to back

Ensure that the cooking utensil is at least 100mm (4") from the front of the shelf.

### Uneven rising

Ensure that the shelf is level (as above) and that the food is positioned correctly in the oven.

### Overcooking

Remember to reduce cooking temperatures by 10°C from standard recipes when using the top oven.

### Food is taking too long to cook

Ensure that the cooking utensil used in the top oven is not larger than 300mm x 225mm (12"x 9"), e.g. Do Not use the main oven meat pan.

Only cook one item at a time to avoid overloading the oven.

# Care and Cleaning

GB

**Warning: Before cleaning, please ensure that the electricity supply to the appliance is switched off and the appliance is fully cold.**

**! Never use steam cleaners or pressure cleaners on the appliance.**

! Clean the glass part of the oven door using a sponge and a non-abrasive cleaning product, then dry thoroughly with a soft cloth. Do not use rough abrasive material or sharp metal scrapers as these could scratch the surface and cause the glass to crack.

! The accessories can be washed like everyday crockery (even in your dishwasher).

## 1. CATALYTIC OVEN LINERS (Top Oven Sides, Main Oven Sides and Rear Panel)

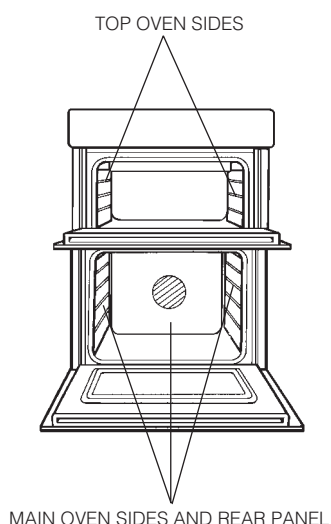

### (a) How catalytic oven liner works.

The surfaces of the oven liners are treated with a special vitreous enamel which absorbs cooking soils.

At temperatures of 220°C (425°F) or above, the special surface enables these soils to be slowly destroyed. The higher the temperature the more effective it is.

### (b) Cleaning.

In most cases normal cooking operations at 220°C (425°F) will permit this cleaning operation to proceed during cooking. However if higher cooking temperatures are not used regularly, it may be necessary, in order to prevent heavy soiling, to run the ovens without shelves or meat pan, at a maximum setting for a couple of hours.

It should not normally be necessary to clean the panels with water. If the user feels it is desirable to do so, wipe them over with a clean, soapy cloth, followed by a wipe with a clean damp cloth.

**DO NOT use biological washing powder, harsh abrasives or chemical oven cleaners of any kind as this could damage the "Stayclean" oven liners.**

## 2. CLEANING GRILL, TOP OVEN AND MAIN OVEN

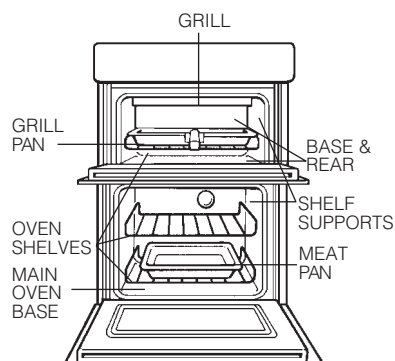

### (a) Base & Rear of Top Oven and Base of Main Oven.

Wipe out the oven with a damp soapy cloth. For more stubborn stains on the base of the oven use a well soaped fine steel wool soap pad.

### (b) Grill Pan, Meat Pan & Oven Shelves.

To prevent stains from being burnt on to the grill pan, food support and rod shelf, always wash immediately after use in warm soapy water. Use a well soaped fine steel wool soap pad to remove stubborn stains from the rod shelves, grill pan, meat pan and the base of the oven.

**DO NOT use aerosol cleaners on this oven as they could adversely affect the fan motor unit, and cannot be wiped off the fan blade.**

## 3. OVEN DOORS

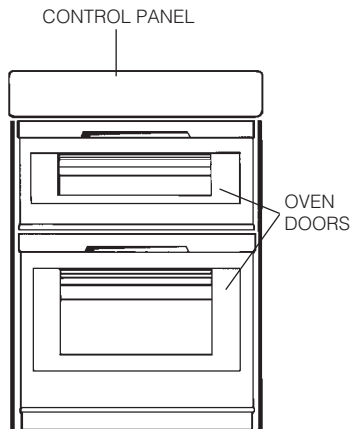

### (a) Control Panel

Regularly wipe with a clean, damp cloth and polish with a clean, dry cloth.

### (b) Inner Door Panels & Glass

Open the door fully. The glass panel may now be washed. Stubborn stains can be removed by using a well soaped, fine steel wool soap pad.

### (c) Stainless trims (FIU20IX)

Regularly wipe with a clean, damp cloth and polish with a clean dry cloth.

**DO NOT use scouring pads, or abrasive powder, which will scratch the glass.**

## 4. REPLACEMENT OF THE OVEN LAMP

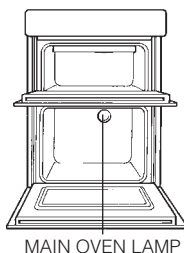

**Warning: To avoid electric shocks - please ensure that the electricity supply to the appliance is switched off and the appliance is fully cold, before removing the lamp lens.**

Open the oven door and remove the oven shelves. Using a thick cloth, grip the lamp lens, unscrew anticlockwise and remove the lens. Carefully unscrew the bulb anti-clockwise. Fit replacement bulb (25W 300°C SES) and refit lens.

## 5. HOW TO CLEAN THE LAMP LENS

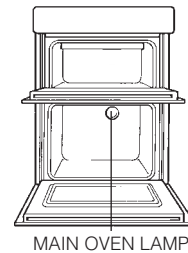

**Warning: To avoid electric shocks - please ensure that the electricity supply to the appliance is switched off and the appliance is fully cold, before cleaning lamp lens.**

Open the oven door and remove the oven shelves. Using a thick cloth, grip the lamp lens, unscrew anticlockwise and remove. Clean with a non-abrasive cleansing cream and refit lamp lens.

**DO NOT use scouring pads, or abrasive powder, which will scratch the glass lens**

# Care and Cleaning

GB

**Take particular care not to damage the inner surface of the door inner glass that is coated with a heat reflective layer. Do not use scouring pads, or abrasive powder, which will scratch the glass. Ensure that the glass panel is not subjected to any sharp mechanical blows.**

Stubborn stains can be removed by using a fine steel wool pad. For slight soiling the inner glass panel may be cleaned, while still warm, without removing it from the door. After cleaning, rinse and dry with a soft cloth.

## CLEANING THE DOORS

### SIDE OPENING DOORS

**Cleaning the door glass is the same as the drop down doors, except take care to support the weight of the inner glass when removing and refitting.**

### DROP DOWN DOORS

Remove the door inner glass as follows.

1. Open the door fully and unscrew the two screws securing the glass panel so that the securing brackets can be turned. There is no need to remove the screws completely.

2. Turn the brackets so that the glass can be removed and cleaned at the sink (Fig. 1.).

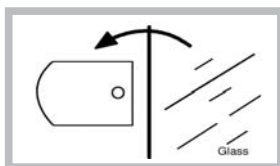

3. The inside of the outer door glass can now be cleaned while still fitted to the cooker.

## NEVER OPERATE THE COOKER WITHOUT THE INNER DOOR GLASS IN POSITION.

**Refit the door inner glass as follows.**

1. **NOTE:** The inner door glass has a special reflective coating on one side. Replace the door inner glass so that the statement: "**IMPORTANT THIS FACE TOWARDS THE OVEN**" can be read from the inner side of the door.

2. Turn the two securing brackets back to their original position to retain the glass and tighten the screws (Fig. 2.)

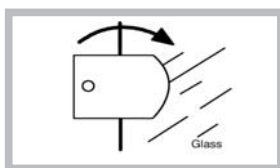

## Electrical Requirements

For your own safety, we recommend that your cooker is installed by a competent person such as one who is registered with NICEIC (National Inspection Council for Electrical Installation Contracting). The cooker should be installed in accordance with the latest edition of the IEE Regulations.

**Warning: This appliance must be earthed.**

## Electrical Connections

The installer must check that the voltage shown on the rating plate corresponds with the house electricity supply. The cooker must be supplied via a suitable double pole isolating switch, having a contact separation of at least 3mm in all poles placed in a readily accessible position adjacent to the cooker. If the cooker is to be wired into a connector unit, this may be positioned behind the cooker providing the following requirements are met:

- The connector unit must not project from the wall more than 25mm.
- The top of the connector must not be more than 130mm above floor level.

Remove the terminal cover at the rear base of the cooker. Pass the cable through the cable clamp and connect to the appropriate terminals provided. Allow sufficient cable for any future servicing. Tighten the screws on the cable clamp and replace the cover. Make main connections in the connector unit or cooker control unit. This appliance conforms to B.S. EN 55014 regarding suppression of Radio and Television reception interference. A double Pole control switch having a minimum rating of 32 amps should be used to feed the cooker using a suitably rated cable. Where a hob is fitted adjacent to or over the cooker, a 45 amp Double Pole control switch should be used to feed both units via separate suitably rated cables. We recommend a minimum of 4mm<sup>2</sup> PVC insulated twin and earth cable conforming to B.S. 6004 for connection of each appliance.

**In all cases adhere to routing details (see fig. 5).**

This appliance must not be installed over any other appliance that generates heat such as a plinth heater.

**Note: Due to many different types of installation, a mains cable is not supplied with this product. The installer will fit the correct type and length of cable.**

## GENERAL

The appliance is designed to be mounted on a floor between two adjacent cabinets. The cabinets must be securely fixed to the wall and the cooker securely fixed to the cabinets.

This cooker must not be used free standing.  
Note; This cooker must not be fitted on a platform.

## FINAL INSTALLATION

- Ensure that the adjacent cabinets and the gap between them have dimensions in accordance with the diagram.
- Assemble the plastic plugs provided into the fixing brackets. See diagram.
- Fix the fixing brackets to the sides of the adjacent cabinets so that the centre line of the brackets are 570mm above the top of the plinth line and the front face of the plastic plug is level with the front face of the cabinet sides. See diagram.
- Adjust the feet on the cooker to their minimum position, i.e. fully screwed in.
- Slide the cooker centrally into the space between the cabinets ensuring the following:
  - The gap between the cabinet sides and the cooker is even along the length of the cabinet sides.
  - The cable is routed away from any vents in the rear panel and is not trapped between the cooker and the wall, adjacent cabinets or under the feet
- Adjust the feet using an open ended spanner until the bottom of the cooker door is in line with the top of the plinth. Using a spirit level, check that the cooker is level in all directions.
- Check that the plinth can be fitted. If necessary re-adjust the feet and check that the cooker is level. Then lock the feet into position by tightening the lock nut using an open ended spanner.
- Open the top oven door and fix the cooker to the brackets through the holes in the side trims.
- Fix the plinth in position.
- Ensure that there is a minimum gap of 1mm between the cooker side trim and the adjacent cabinet doors or drawer fronts.
- If a hob is to be installed directly above the cooker it must not project downwards more than 20mm below the underside of the work top. Any projection of more than 10mm must not project more than 500mm from the wall.

**Fig. 5**

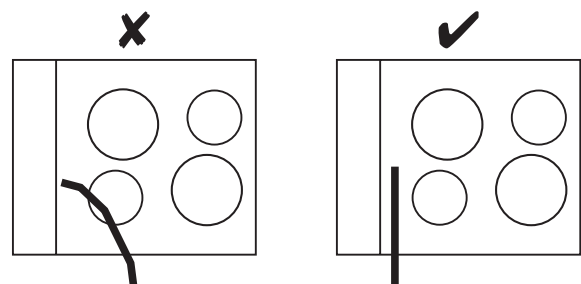

# Installation

GB

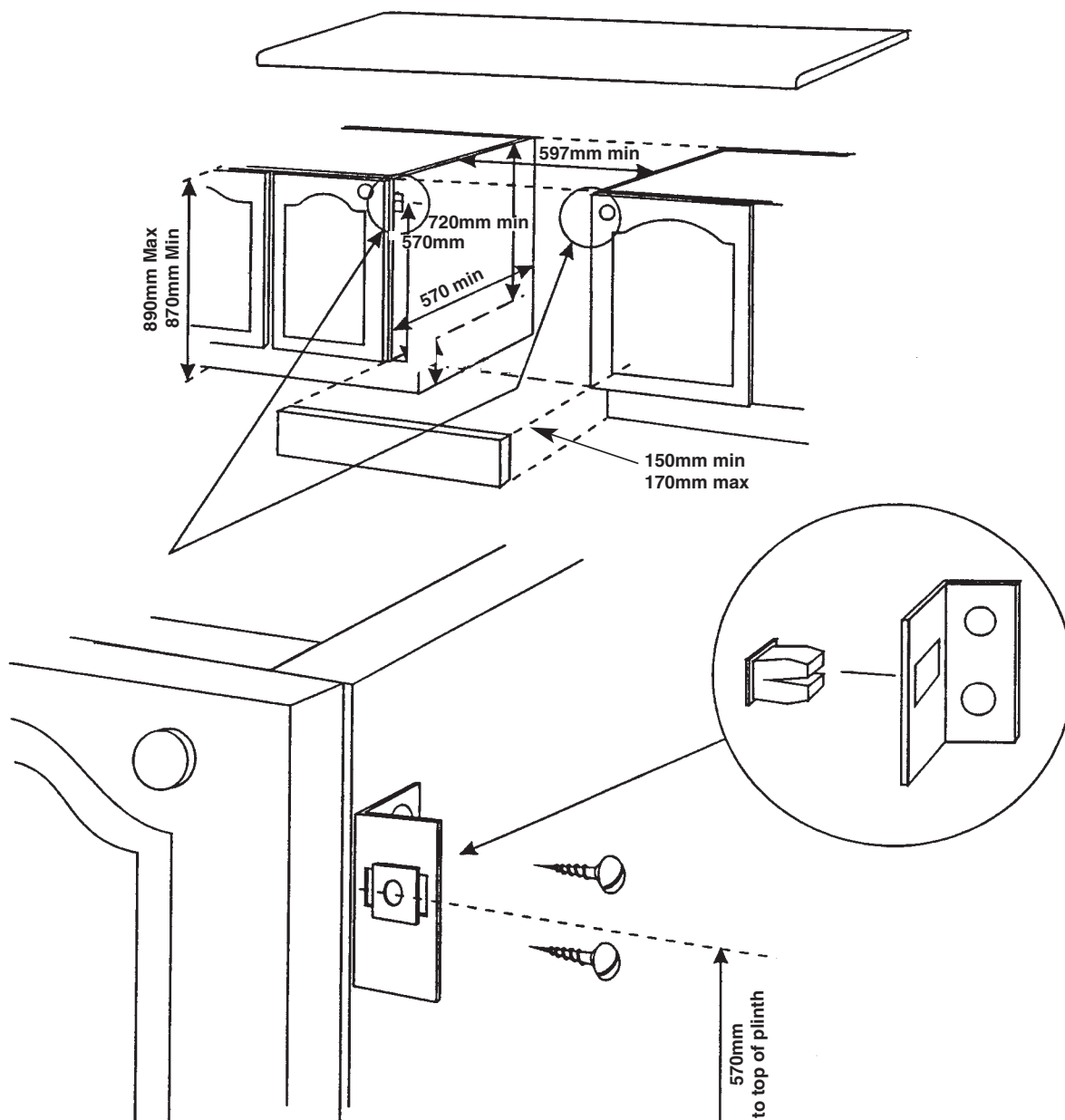

A minimum distance of 25mm should be maintained between the front face of the cabinet side and the front face of the plinth.



# If Something Goes Wrong?

Before calling a Service Engineer, please check through the following lists.  
THERE MAY BE NOTHING WRONG.

Problem	Check
Slight odour or small amount of smoke when grill/oven is used for the first time.	This is normal and should cease after a short period.
Nothing works.	If you find :-  Display is blank.  <b>Then it is likely that there is no electricity supply to your oven.</b>  Check: (i) That the main cooker wall switch is turned on. (ii) Check other appliances to see if you have a power cut. (iii) Check the main circuit breaker for the property.
Timer Display "0.00 AUTO"	The power supply to your oven has possibly been interrupted, but has now come back on again. Reset the timer to the correct time of day and "Manual" operation using the instructions given in the timer section of the book.
Main Oven does not work, but the Grill and Top Oven work.	<b>Check the following to ensure that the timer is in Manual Mode:</b>  Check that the Auto Symbol is <u>not</u> lit up and is not flashing.  <b>See timer section for instructions on how to return timer to "Manual".</b>
Top Ovens and Grill do not work, but the Main Oven works.	Operating the cooker under the following conditions may cause a safety device to operate.  (a) Grilling with the door closed - always grill with the door open to the correct position - see grilling (b) Grilling for an excessively long period at maximum setting - see grilling guide. (c) Grilling with inadequate ventilation in the cabinet - see installation instructions.
Grill keeps turning on and off	When the "Grill" control (A) is operating at less than MAX, the grill will cycle on and off, this is normal and is not a fault.
Can not set an "Auto Cook" programme	Remember: "Cook Period" is the actual length of time for which, the timer will switch the oven(s) on as part of an "Auto Cooking" programme.
Draught from beneath control panel.	A gentle flow of air will be blown from beneath the control panel when the appliance is used. If the appliance is still warm, this cooling fan may run on, or restart itself after all of the controls have been turned off. The fan will stop once the appliance has been cooled. This is normal and <u>not</u> a fault.
Timer buzzer/bleeper operates continually	Press the minute minder button to silence the Buzzer/Bleeper.

If you have been through the above list and there is still a problem, contact Service (see Back Page).

# If it Still Won't Work

GB

## Contact the Service Office

If something is still wrong with your appliance after you have been through the 'Something Wrong' list:

1. Switch off and unplug the appliance from the mains.
2. Call your nearest Service Office or local importer.

When you contact us we will want to know the following:

1. Your name, address and postcode.
2. Your telephone number.
3. Clear and concise details of the fault.
4. The Model number and the Serial number of your appliance.
5. The date of purchase (please keep the receipt as evidence will be required when an engineer calls) enter the date here:

.....  
Please make sure you have all these details ready when you call.

## Spare Parts

Please remember your new appliance is a complex piece of equipment. 'DIY' repairs or unqualified and untrained service people may put you in danger, could damage the appliance and might mean you lose cover under the Parts Guarantee. If you do experience a problem with the appliance don't take risks, call in our Service Engineer. Our Parts are designed exclusively to fit your appliance. Do not use them for any other purpose as you may create a safety hazard.

## Disposal of your product

To minimise the risk of injury to children please dispose of your product carefully and safely. Remove all doors and lids. Remove the mains cable (where fitted) by cutting off flush with the appliance and always ensure that no plug is left in a condition where it could be connected to the electricity supply.

To help the environment, Local Authority instructions should be followed for the disposal of your product.



## Disposal of old electrical appliances

The European Directive 2002/96/EC on Waste Electrical and Electronic Equipment (WEEE), requires that old household electrical appliances must not be disposed of in the normal unsorted municipal waste stream. Old appliances must be collected separately in order to optimise the recovery and recycling of the materials they contain and reduce the impact on human health and the environment.

The crossed out "wheeled bin" symbol on the product reminds you of your obligation, that when you dispose of the appliance it must be separately collected.

Consumers should contact their local authority or retailer for information concerning the correct disposal of their old appliance.

## Guarantee

### 12 months Parts and Labour Guarantee

Your appliance has the benefit of our manufacturer's guarantee, which covers the cost of breakdown repairs for twelve months from the date of purchase.

This gives you the reassurance that if, within that time, your appliance is proven to be defective because of either workmanship or materials, we will, at our discretion, either repair or replace the appliance at no cost to you.

This guarantee is subject to the following conditions:

- The appliance has been installed and operated correctly and in accordance with our operating and maintenance instructions.
- The appliance is used only on the electricity or gas supply printed on the rating plate.
- The appliance has been used for normal domestic purposes only.
- The appliance has not been altered, serviced, maintained, dismantled, or otherwise interfered with by any person not authorised by us.
- Any repair work must be undertaken by us or our appointed agent.
- Any parts removed during repair work or any appliance that is replaced become our property.
- The appliance is used in the United Kingdom or Republic of Ireland.

The guarantee does not cover:

- Damage resulting from transportation, improper use, neglect or interference or as a result of improper installation.
- Replacement of any consumable item or accessory. These included but not limited to: plugs, cables, batteries, light bulbs, fluorescent tubes and starters, covers and filters.
- Replacement of any removable parts made of glass or plastic.

**THIS GUARANTEE WILL NOT APPLY IF THE APPLIANCE HAS BEEN USED IN COMMERCIAL OR NON-DOMESTIC PREMISES.**

### 5 Year Parts Guarantee

Indesit also offers you a free 5 year parts guarantee. This additional guarantee is conditional on you registering your appliance with us and the parts being fitted by one of our authorised engineers. There will be a charge for our engineer's time. To activate the extra parts warranty on your appliance, simply call our registration line on 08448 24 24 24 (Republic of Ireland 01 230 0800)

### Extended Guarantees

We offer a selection of protection plans that enable you to fully cover yourself against the expense of repair bills for the life of your policy. To find the ideal plan for you please call our advice line on 08448 226 226 (Republic of Ireland 01 230 0233).

### Free Helpdesk Service

We have a dedicated team who can provide free advice and assistance with your appliance if you experience any technical difficulties within the first 90 days of ownership. Simply call our Indesit Service Hotline on 08448 224 224 (Republic of Ireland 0818 313 413) for telephone assistance, or, where necessary, to arrange for an engineer to call.



## After Sales Service

No one is better placed to care for your Indesit appliance during the course of its working life than us – the manufacturer.

### Essential Contact Information

#### Indesit Service

We are the largest service team in the UK and Ireland offering you access to 400 skilled telephone advisors and 1000 fully qualified engineers on call to ensure you receive fast, reliable, local service.

**UK: 08448 224 224**  
**Republic of Ireland: 0818 313 413**  
**[www.indesitservice.co.uk](http://www.indesitservice.co.uk)**

**Please note: Our advisors will require the following information:**

**Model number:**

**Serial number:**

#### Parts and Accessories

We supply a full range of genuine replacement parts as well as accessory products that protect and hygienically clean your appliance to keep it looking good and functioning efficiently throughout its life.

**UK: 08448 225 225**  
**Republic of Ireland: 0818 313 413**  
**[www.indesitservice.co.uk](http://www.indesitservice.co.uk)**

#### Appliance Registration

We want to give you additional benefits of Indesit ownership. To activate your free 5 year parts guarantee you must register your appliance with us.

**UK: 08448 24 24 24**  
**Republic of Ireland: 01 230 0800**  
**[www.indesitservice.co.uk](http://www.indesitservice.co.uk)**

**Indesit Company UK Ltd. Morley Way, Peterborough, PE2 9JB**  
Indesit Company Unit 49 Airways Industrial Estate, Dublin 17

#### Recycling and Disposal Information

As part of Indesit's continued commitment to helping the environment, Indesit reserves the right to use quality, recycled components to keep down customer costs and minimise material wastage.

Please dispose of packaging and old appliances carefully. To minimise the risk of injury to children, remove the door, plug, and cut the mains cable off flush with the appliance. Dispose of these parts separately to ensure that the appliance can no longer be plugged into mains socket, and the door cannot be locked shut.



