



Thank you for choosing Philips.

Need help fast?

Read your Quick Start Guide and/or User Manual first for quick tips that make using your Philips product more enjoyable.

If you have read your instructions and still need assistance, you may access our online help at

www.philips.com/welcome
or call

1-888-PHILIPS (744-5477)
while with your product.
(and Model / Serial number)



Philips vous remercie de votre confiance.

Besoin d'une aide rapide?

Le Guide rapide de début et Manuel de l'utilisateur regorgent d'astuces destinées à simplifier l'utilisation de votre produit Philips. Toutefois, si vous ne parvenez pas à résoudre votre problème, vous pouvez accéder à notre aide en ligne à l'adresse

www.philips.com/welcome
ou formez le

1-800-661-6162 (Francophone)
1-888-PHILIPS (744-5477) (English speaking)
Veillez à avoir votre produit à portée de main.
(et model / serial nombre)



Gracias por escoger Philips

Necesita ayuda inmediata?

Lea primero la Guía rápida del comienzo o el Manual del usuario, en donde encontrará consejos que le ayudarán a disfrutar plenamente de su producto Philips.

Si después de leerlo aún necesita ayuda, consulte nuestro servicio de asistencia en línea en

www.philips.com/welcome
o llame al teléfono

1-888-PHILIPS (744-5477)
y tenga a mano el producto.
(y número de model / serial)



EN User manual

ES Manual del usuario

FR Mode d'emploi

PHILIPS

Canada

English:

This digital apparatus does not exceed the Class B limits for radio noise emissions from digital apparatus as set out in the Radio Interference Regulations of the Canadian Department of Communications. This Class B digital apparatus complies with Canadian ICES-003.

Français:

Cet appareil numérique n'émet pas de bruits radioélectriques dépassant les limites applicables aux appareils numériques de Classe B prescrites dans le Règlement sur le Brouillage Radioélectrique édicté par le Ministère des Communications du Canada. Cet appareil numérique de la classe B est conforme à la norme NMB-003 du Canada.

The set complies with the FCC-Rules, Part 15 and with 21 CFR 1040.10. Operation is subject to the following two conditions:

1. This device may not cause harmful interference, and
2. This device must accept any interference received, including interference that may cause undesired operation.

L'appareil est conforme à la réglementation FCC, section 15, et à la norme 21 CFR 1040.10. Son utilisation est soumise à deux conditions :

1. L'appareil ne doit pas provoquer d'interférences nuisibles, et
2. L'appareil doit supporter les interférences reçues, y compris les interférences empêchant son fonctionnement correct.

Contents

1 Important	6
Safety	6
Notice	7

2 Your kitchen clock radio	8
Introduction	8
What's in the box	8
Overview of the main unit	9
Overview of the remote control	10

3 Get started	11
Mounting the set under your kitchen cabinet	11
Install remote control battery	11
Connect power	12
Set time and date	12
Turn on	12

4 Play	13
Play from iPod/iPhone	13
Tune to a radio station	13
Program radio stations automatically	14
Program radio stations manually	14
Select a preset radio station	14

5 Adjust sound	15
Adjust the volume level	15
Mute sound	15
Select a preset sound effect	15
Enhance bass	15

6 Other features	16
Set a kitchen timer	16
Adjust display brightness	16

7 Product information	17
Specifications	17

8 Troubleshooting	18
--------------------------	----

**Return your Product Registration Card or register online at
www.philips.com/welcome today to get the very most from your purchase.**

Registering your model with PHILIPS makes you eligible for all of the valuable benefits listed below, so don't miss out. Complete and return your Product Registration Card at once, **or register online at www.philips.com/welcome** to ensure:

***Proof of Purchase**

Returning the enclosed card guarantees that your date of purchase will be on file, so no additional paperwork will be required from you to obtain warranty service.

***Product Safety Notification**

By registering your product, you'll receive notification - directly from the manufacturer - in the rare case of a product recall or safety defect.

***Additional Benefits**

Registering your product guarantees that you'll receive all of the privileges to which you're entitled, including special money-saving offers.

PHILIPS

Congratulations on your purchase, and welcome to the "family!"

Dear PHILIPS product owner:

Thank you for your confidence in PHILIPS. You've selected one of the best-built, best-backed products available today. We'll do everything in our power to keep you happy with your purchase for many years to come. As a member of the PHILIPS "family," you're entitled to protection by one of the most comprehensive warranties and outstanding service networks in the industry. What's more, your purchase guarantees you'll receive all the information and special offers for which you qualify, plus easy access to accessories from our convenient home shopping network.

Most importantly, you can count on our uncompromising commitment to your total satisfaction.

All of this is our way of saying welcome - and thanks for investing in a PHILIPS product.

P.S. To get the most from your PHILIPS purchase, be sure to complete and return your Product Registration Card at once, or register online at:

www.philips.com/welcome

Know these
safety symbols



 This "bolt of lightning" indicates insulated material within your unit may cause an electrical shock. For the safety of everyone in your household, please do not remove product covering.

 The "exclamation point" calls attention to features for which you should read the enclosed literature closely to prevent operating and maintenance problems.

WARNING: To reduce the risk of fire or electric shock, this apparatus should not be exposed to rain or moisture and objects filled with liquids, such as vases, should not be placed on this apparatus.

CAUTION: To prevent electric shock, match wide blade of plug to wide slot, fully insert.

ATTENTION: Pour éviter les choc électriques, introduire la lame la plus large de la fiche dans la borne correspondante de la prise et pousser jusqu'au fond.

For Customer Use

Enter below the Serial No. which is located on the rear of the cabinet. Retain this information for future reference.

Model No. _____

Serial No. _____

PHILIPS

Visit our World Wide Web Site at <http://www.philips.com/welcome>

PHILIPS LIMITED WARRANTY ONE (1) YEAR

WARRANTY COVERAGE:

PHILIPS warranty obligation is limited to the terms set forth below.

WHO IS COVERED:

Philips warrants the product to the original purchaser or the person receiving the product as a gift against defects in materials and workmanship as based on the date of original purchase ("Warranty Period") from an Authorized Dealer. The original sales receipt showing the product name and the purchase date from an authorized retailer is considered such proof.

WHAT IS COVERED:

The Philips warranty covers new products if a defect in material or workmanship occurs and a valid claim is received by Philips within the Warranty Period. At its option, Philips will either (1) repair the product at no charge, using new or refurbished replacement parts, or (2) exchange the product with a product that is new or which has been manufactured from new, or serviceable used parts and is at least functionally equivalent or most comparable to the original product in Philips current inventory, or (3) refund the original purchase price of the product. Philips warrants replacement products or parts provided under this warranty against defects in materials and workmanship from the date of the replacement or repair for ninety (90) days or for the remaining portion of the original product's warranty, whichever provides longer coverage for you. When a product or part is exchanged, any replacement item becomes your property and the replaced item becomes Philips' property. When a refund is given, your product becomes Philips' property.

Note: Any product sold and identified as refurbished or renewed carries a ninety (90) day limited warranty.

Replacement product can only be sent if all warranty requirements are met. Failure to follow all requirements can result in delay.

WHAT IS NOT COVERED - EXCLUSIONS AND LIMITATIONS:

This Limited Warranty applies only to the new products manufactured by or for Philips that can be identified by the trademark, trade name, or logo affixed to it. This Limited Warranty does not apply to any non-Philips hardware product or any software, even if packaged or sold with the product. Non-Philips manufacturers, suppliers, or publishers may provide a separate warranty for their own products packaged with the bundled product.

Philips is not liable for any damage to or loss of any programs, data, or other information stored on any media contained within the product, or any non-Philips product or part not covered by this warranty. Recovery or reinstallation of programs, data or other information is not covered under this Limited Warranty.

This warranty does not apply (a) to damage caused by accident, abuse, misuse, neglect, misapplication, or non-Philips product, (b) to damage caused by service performed by anyone other than Philips or Philips Authorized Service Location, (c) to a product or a part that has been modified without the written permission of

Philips, or (d) if any Philips serial number has been removed or defaced, or (e) product, accessories or consumables sold "AS IS" without warranty of any kind by including refurbished Philips product sold "AS IS" by some retailers.

This Limited Warranty does not cover:

- Shipping charges to return defective product to Philips.
- Labor charges for installation or setup of the product, adjustment of customer controls on the product, and installation or repair of antenna/signal source systems outside of the product.
- Product repair and/or part replacement because of improper installation or maintenance, connections to improper voltage supply, power line surge, lightning damage, retained images or screen markings resulting from viewing fixed stationary content for extended periods, product cosmetic appearance items due to normal wear and tear, unauthorized repair or other cause not within the control of Philips.
- Damage or claims for products not being available for use, or for lost data or lost software.
- Damage from mishandled shipments or transit accidents when returning product to Philips.
- A product that requires modification or adaptation to enable it to operate in any country other than the country for which it was designed, manufactured, approved and/or authorized, or repair of products damaged by these modifications.
- A product used for commercial or institutional purposes (including but not limited to rental purposes).
- Product lost in shipment and no signature verification receipt can be provided.
- Failure to operate per Owner's Manual.

TO OBTAIN ASSISTANCE IN THE U.S.A., PUERTO RICO, OR U.S. VIRGIN ISLANDS...

Contact Philips Customer Care Center at:
1-888-PHILIPS (1-888-744-5477)

TO OBTAIN ASSISTANCE IN CANADA...

1-800-661-6162 (French Speaking)
1-888-PHILIPS (1-888-744-5477) - (English or Spanish Speaking)

REPAIR OR REPLACEMENT AS PROVIDED UNDER THIS WARRANTY IS THE EXCLUSIVE REMEDY FOR THE CONSUMER. PHILIPS SHALL NOT BE LIABLE FOR ANY INCIDENTAL OR CONSEQUENTIAL DAMAGES FOR BREACH OF ANY EXPRESS OR IMPLIED WARRANTY ON THIS PRODUCT, EXCEPT TO THE EXTENT PROHIBITED BY APPLICABLE LAW, ANY IMPLIED WARRANTY OF MERCHANTABILITY OR FITNESS FOR A PARTICULAR PURPOSE ON THIS PRODUCT IS LIMITED IN DURATION TO THE DURATION OF THIS WARRANTY.

Some states do not allow the exclusions or limitation of incidental or consequential damages, or allow limitations on how long an implied warranty lasts, so the above limitations or exclusions may not apply to you.

This warranty gives you specific legal rights. You may have other rights which vary from state/province to state/province.

Philips, P.O. Box 10313 Stamford, CT 06904

3140 035 50201

1 Important

Safety

- ① Read these instructions.
- ② Keep these instructions.
- ③ Heed all warnings.
- ④ Follow all instructions.
- ⑤ Do not use this apparatus near water.
- ⑥ Clean only with dry cloth.
- ⑦ Do not block any ventilation openings. Install in accordance with the manufacturer's instructions.
- ⑧ Do not install near any heat sources such as radiators, heat registers, stoves, or other apparatus (including amplifiers) that produce heat.
- ⑨ Protect the power cord from being walked on or pinched, particularly at plugs, convenience receptacles, and the point where they exit from the apparatus.
- ⑩ Only use attachments/accessories specified by the manufacturer.
- ⑪ Use only with the cart, stand, tripod, bracket, or table specified by the manufacturer or sold with the apparatus. When a cart is used, use caution when moving the cart/apparatus combination to avoid injury from tip-over.
- ⑫ Unplug this apparatus during lightning storms or when unused for long periods of time.
- ⑬ Refer all servicing to qualified service personnel. Servicing is required when the apparatus has been damaged in any way, such as power-supply cord or plug is damaged, liquid has been spilled or objects have fallen into the apparatus, the apparatus has been exposed to rain or moisture, does not operate normally, or has been dropped.
- ⑭ Apparatus shall not be exposed to dripping or splashing.
- ⑮ Do not place any sources of danger on the apparatus (e.g. liquid filled objects, lighted candles).
- ⑯ This product may contain lead and mercury. Disposal of these materials may be regulated due to environmental considerations. For disposal or recycling information, please contact your local authorities or the Electronic Industries Alliance: www.eiae.org.
- ⑰ Where the plug is used as the disconnect device, the disconnect device shall remain readily operable.
 - Where the MAINS plug or an appliance coupler is used as the disconnect device, the disconnect device shall remain readily operable.



Warning

- Never remove the casing of this apparatus.
- Never lubricate any part of this apparatus.
- Never place this apparatus on other electrical equipment.
- Keep this apparatus away from direct sunlight, naked flames or heat.
- Ensure that you always have easy access to the power cord, plug or adaptor to disconnect the apparatus from the power.



**Caution**

- To reduce the risk of fire, do not place any heating or cooking apparatus beneath this unit.

Notice

Notice for the USA

This equipment has been tested and found to comply with the limits for a Class B digital device, pursuant to part 15 of the FCC Rules. These limits are designed to provide reasonable protection against harmful interference in a residential installation. This equipment generates, uses, and can radiate radio frequency energy and, if not installed and used in accordance with the instruction manual, may cause harmful interference to radio communications.

However, there is no guarantee that interference will not occur in a particular installation. If this equipment does cause harmful interference to radio or television reception, which can be determined by turning the equipment off and on, the user is encouraged to try to correct the interference by one or more of the following measures:

- Relocate the receiving antenna.
- Increase the separation between equipment and receiver.
- Connect the equipment into an outlet on a circuit different from that to which the receiver is connected.
- Consult the dealer or an experienced radio/TV technician for help.

Any changes or modifications made to this device that are not expressly approved by Philips Consumer Lifestyle may void the user's authority to operate the equipment.

Disposal of your old product and batteries

Your product is designed and manufactured with high quality materials and components, which can be recycled and reused. Never dispose of your product with other household waste. Please inform yourself about the local rules on the separate collection of electrical and electronic products and batteries. The correct disposal of these products helps prevent potentially negative consequences on the environment and human health.

Your product contains batteries, which cannot be disposed of with normal household waste. Please inform yourself about the local rules on separate collection of batteries. The correct disposal of batteries helps prevent potentially negative consequences on the environment and human health.

Please visit www.recycle.philips.com for additional information on a recycling center in your area.

**Caution**

- Removal of the built-in battery invalidates the warranty and may destroy the product.

Environmental information

All unnecessary packaging has been omitted. We have tried to make the packaging easy to separate into three materials: cardboard (box), polystyrene foam (buffer) and polyethylene (bags, protective foam sheet.)

Your system consists of materials which can be recycled and reused if disassembled by a specialized company. Please observe the local regulations regarding the disposal of packaging materials, exhausted batteries and old equipment.

2 Your kitchen clock radio

Congratulations on your purchase, and welcome to Philips! To fully benefit from the support that Philips offers, register your product at www.philips.com/welcome.

Introduction

With this unit, you can:

- enjoy audio from iPod players or iPhone
- listen to FM/AM radio stations
- know the time
- set a kitchen timer

You can enrich sound output with these sound effects:

- Digital Sound Control (DSC)
- Dynamic Bass Boost (DBB)

What's in the box

Check and identify the contents of your package:

- Main unit
- Remote control
- 1 x AC adapter
- Mounting kit
- User manual
- Quick start guide

Overview of the main unit

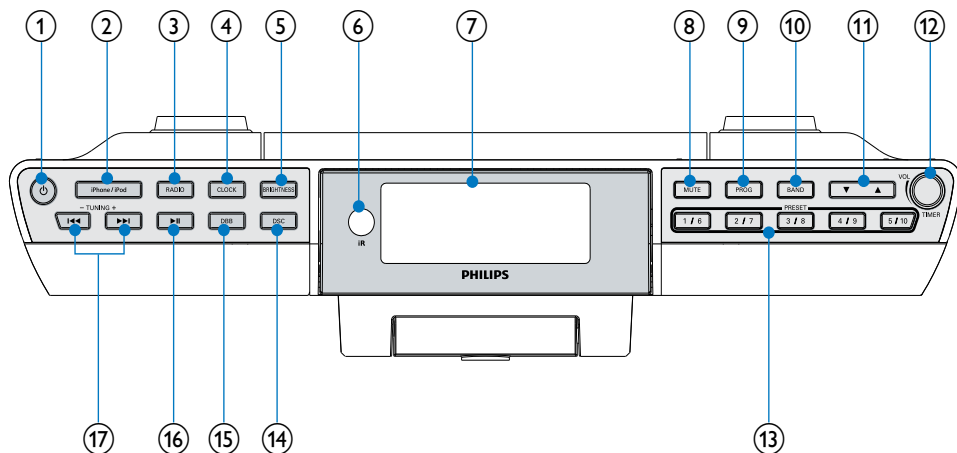

- ① **⏻**
 - Turn on the unit or switch to standby mode.
- ② **iPhone/iPod**
 - Switch to Phone/iPod.
- ③ **RADIO**
 - Turn on radio.
- ④ **CLOCK**
 - Set date/time.
- ⑤ **BRIGHTNESS**
 - Adjust display brightness.
- ⑥ **iR**
 - Remote control sensor.
- ⑦ **Display panel**
 - Show current status.
- ⑧ **MUTE**
 - Mute sound or to resume.
- ⑨ **PROG**
 - Program radio stations automatically.
- ⑩ **BAND**
 - Select FM or AM band.
- ⑪ **▼/▲**
 - Select a preset radio station.
- ⑫ **TIMER/VOL**
 - Turn timer on/off.
 - Adjust volume.
- ⑬ **PRESET 1/8 2/7 3/8 4/9 5/10**
 - Select preset radio stations.
- ⑭ **DSC**
 - Select a preset sound setting.
- ⑮ **DBB**
 - Turn on/off dynamic bass enhancement.
- ⑯ **▶||**
 - Start or pause iPod/iPhone play.
- ⑰ **⏮⏭**
 - Skip to previous/next audio file.
 - Tune for radio station.

Overview of the remote control

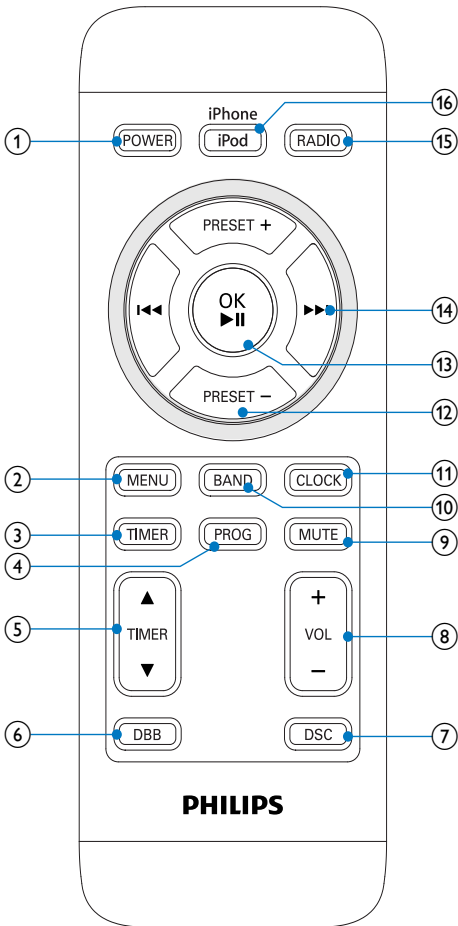

- ① **POWER**
 - Turn on the unit or switch to standby mode.
- ② **MENU**
 - View time.
- ③ **TIMER**
 - Turn timer on/off.
- ④ **PROG**
 - Program radio stations automatically.

- ⑤ **▲TIMER▼**
 - To set timer.
- ⑥ **DBB**
 - Turn on/off dynamic bass enhancement.
- ⑦ **DSC**
 - Select a preset sound setting.
- ⑧ **VOL +/-**
 - Adjust volume.
- ⑨ **MUTE**
 - Mute sound or to resume.
- ⑩ **BAND**
 - Select FM or AM band.
- ⑪ **CLOCK**
 - Set date/time.
- ⑫ **PRESET +/-**
 - Select preset radio stations.
- ⑬ **OK / >||**
 - Start or pause iPod/iPhone play.
- ⑭ **<<>>**
 - Skip to previous/next audio file.
 - Tune for radio station.
- ⑮ **RADIO**
 - Turn on radio.
- ⑯ **iPod**
 - Switch to iPhone/iPod.

3 Get started

! Caution

- Use of controls or adjustments or performance of procedures other than herein may result in hazardous radiation exposure or other unsafe operation.

Always follow the instructions in this chapter in sequence.

If you contact Philips, you will be asked for the model and serial number of this apparatus. The model number and serial number are on the rear of the apparatus. Write the numbers here:
Model No. _____
Serial No. _____

Mounting the set under your kitchen cabinet

Preparation

☰ Note

- Ask a friend or a professional personnel to safely mount the product under your kitchen cabinet.

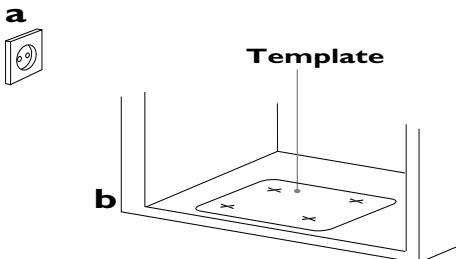

- Find a mounting location near a wall outlet.
- Use the mounting template to test the design and thickness of your kitchen cabinet.
- Decide whether you want to connect the set with other audio/video equipment.

Mounting the set

For full details on how to use the Mounting Kit, please refer to the printed instructions in the **Quick Start Guide** and **Template**.

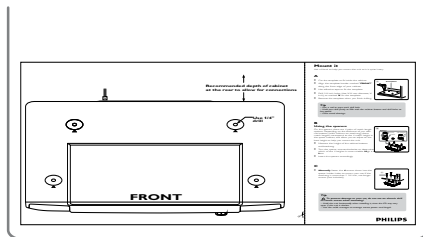

! Warning

- Never plug in the AC power cord to the power outlet before installation is completed.
- Do not use a converter or extension cord.
- Install the set as far as possible from sources of interference, such as a refrigerator, microwave oven, fluorescent lamp, etc.
- There should be at least 2.5" distance between the unit and the wall.

Install remote control battery

! Caution

- Danger of explosion if battery is incorrectly replaced. Replace only with the same or equivalent type.
- Risk of explosion! Keep batteries away from heat, sunshine or fire. Never discard batteries in fire.
- Risk of decreased battery life! Never mix different brands or types of batteries.
- Risk of product damage! When the remote control is not used for long periods, remove the batteries.

☰ Note

- Batteries contain chemical substances, they should be disposed of properly.
- Perchlorate Material - special handling may apply. See www.dtsc.ca.gov/hazardouswaste/perchlorate.

- 1 Open the battery compartment.
- 2 Insert one CR2025 battery with correct polarity (+/-) as indicated.
- 3 Close the battery compartment.

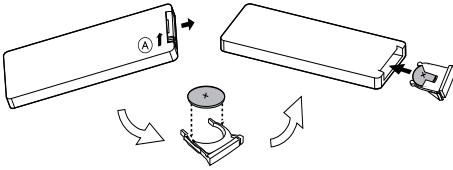

Connect power

! Caution

- Risk of product damage! Ensure that the power voltage corresponds to the voltage printed on the back or underside of the apparatus.
- Risk of electric shock! When you unplug the AC adapter, always pull the plug from the socket. Never pull the cord.
- Before connecting the AC adapter, ensure you have completed all other connections.

☰ Note

- The type plate is located on the rear of the main unit.

- 1 Connect one end of the AC adapter to the **DC IN** socket on the main unit.

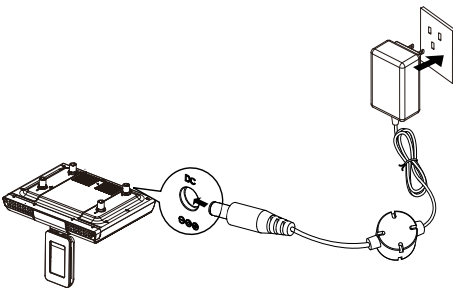

- 2 Connect the other end of the AC adapter to the wall outlet.

Set time and date

- 1 Dock the iPod / iPhone on the unit.
- 2 Open the iPod / iPhone.
 - ↳ Time and date information on the iPod / iPhone transfers to the unit automatically.

To set time and date manually:

- 1 In standby mode, press and hold **CLOCK** for 2 seconds.
 - ↳ The hour digits begin to blink.
- 2 Rotate the knob clockwise/counter-clockwise or press **◀▶** to set the hour.
- 3 Press **CLOCK** to confirm.
 - ↳ The minute digits begin to blink.
- 4 Repeat steps 2-3 to set the minute, year, month, and day.
 - ↳ The week day is displayed automatically.
- 5 Repeat steps 2-3 to select the 12/24 hour format.
- 6 Press **CLOCK** to confirm.

Turn on

- 1 Press **⏻**.
 - ↳ The unit switches to the last selected source.

Switch to standby

- 1 Press **⏻** again to switch the unit to standby mode.
 - ↳ The time is displayed.

4 Play

Play from iPod/iPhone

You can enjoy audio from iPod/iPhone through this unit.

Compatible iPod/iPhone

Apple iPod and iPhone models with a 30-pin dock connector:

- iPod classic, iPod touch, iPod nano, iPod 5th generation (video), iPod with color display, iPod mini.
- iPhone, iPhone 3G, iPhone 3GS.

Place the iPod/iPhone

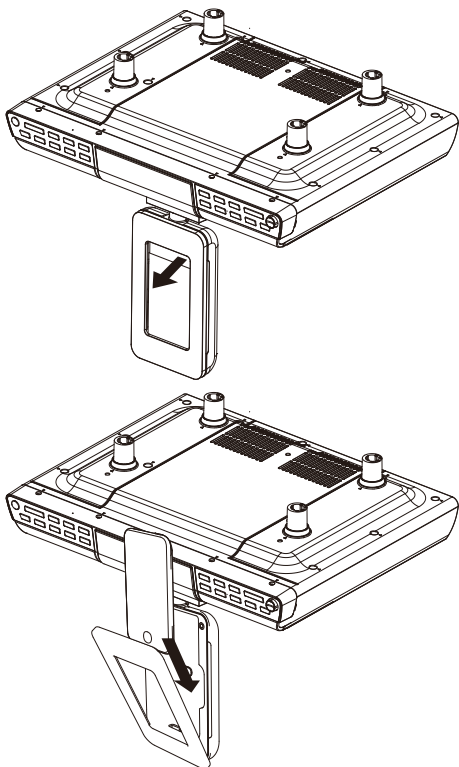

- 1 Lift up the iPhone/iPod dock under the bottom plate.
- 2 Place the iPhone/iPod into the dock.

Remove the iPod/iPhone

- 1 Pull the iPod/iPhone out of the dock.

Listen to the iPod/iPhone

- 1 Ensure that the iPod/iPhone is loaded correctly.
- 2 Press **iPod** to select iPod/iPhone source.
 - ↳ The connected iPod/iPhone plays automatically.
 - To pause/resume play, press **▶||**.
 - To skip to a track, press **◀◀▶▶**.
 - To search during play, press and hold **◀◀▶▶**, then release to resume normal play.

Charge the iPod/iPhone

When the unit is connected to power, the docked iPod/iPhone begins to charge.

Tip

- For certain iPod models, it may take up to a minute before the charging indication appears.

Tune to a radio station

Tip

- Position the antenna as far as possible from TV, VCR or other radiation source.

Note

- For optimal reception, fully extend and adjust the position of the antenna.

- 1 Press **RADIO** to turn on the radio.

- 2 Press **BAND** to select FM or AM tuner.
- 3 Press and hold **PROG** for more than 2 seconds.
 - ↳ [Srch] (search) is displayed.
 - ↳ The radio tunes to a station with strong reception automatically.
- 4 To tune to a weak station, press **◀◀** / **▶▶** repeatedly until you find optimal reception.
- 3 Press **◀◀▶▶** repeatedly to tune to a radio station.
- 4 Press **PROG** .
 - ↳ The number begins to blink.
- 5 Press **PRESET +/-** or **▼/▲** repeatedly to select a preset number.
- 6 Press **PROG** to confirm.
- 7 Repeat the above steps to program more stations.

Program radio stations automatically

Note

- You can program a maximum of 20 preset FM/AM radio stations.

- 1 Press **RADIO** to turn on the radio.
- 2 Press **BAND** to select FM/AM tuner.
- 3 Press and hold **PROG** for 2 seconds.
 - ↳ [Auto] (auto) is displayed.
 - ↳ All available stations are programmed in the order of waveband reception strength.
 - ↳ The first programed radio station broadcasts automatically.

Program radio stations manually

Note

- You can program a maximum of 20 preset FM/AM radio stations.

- 1 Press **RADIO** repeatedly to turn on the radio.
- 2 Press **BAND** to select FM/AM tuner.

Tip

- To overwrite a programmed station, program another station in its place.

Select a preset radio station

- 1 Press **▼/▲** to select a preset radio station.

Tip

- You can also press **PRESET 1/6, 2/7, 3/8, 4/9, 5/10** repeatedly to select a preset radio station.

5 Adjust sound

Adjust the volume level

- 1 Rotate **VOL** or press **VOL +/-** to increase/decrease the volume level.

Mute sound

- 1 During play, press **MUTE** to mute/unmute sound.

Select a preset sound effect

- 1 During play, press **DSC** repeatedly to select:
 - [POP] (pop)
 - [JAZZ] (jazz)
 - [CLASSIC] (classic)
 - [ROCK] (rock)

Enhance bass

- 1 During play, press **DBB** to turn on or off dynamic bass enhancement.
↳ If DBB is activated,  is displayed.

6 Other features

Set a kitchen timer

This unit can be used as an alarm clock.



- 1 At any operation mode, press **TIMER/VOL**.
 - ↳ The last time setting in minute or hour and minute blinks.
- 2 Rotate the knob clockwise/counter-clockwise to choose the desired timer.
- 3 Press **TIMER/VOL** to confirm.
 - ↳ The timer is set and activated.
 - ↳  is displayed and the timer starts counting down.



Note

- You can set an alarm timer from 1 minute through 10 hours.

Activate and deactivate alarm timer

- 1 In any operation mode, press **TIMER/VOL** repeatedly to activate or deactivate timer.
 - ↳ If timer is activated,  starts to blink.
 - ↳ If timer is deactivated,  disappears on the display.

View the alarm settings

- 1 Press **TIMER/VOL**.

Stop alarm ring

- 1 When the alarm rings, press **TIMER/VOL**.
 - ↳ The alarm stops but the alarm settings remain.



Caution

- If you do not stop the alarm ring, the alarm will ring off and the timer starts counting up.

Adjust display brightness

- 1 Press **BRIGHTNESS** repeatedly to select different levels of display brightness.

7 Product information



Note

- Product information is subject to change without prior notice.

Specifications

Amplifier

Rated Output Power	2 x 2 W RMS
Frequency Response	80 Hz - 16 kHz, ± 3 dB
Signal to Noise Ratio	> 60 dB
Total Harmonic Distortion	< 1%

Tuner

FM

Tuning Range	87.5 - 108 MHz
Tuning grid	100 KHz
Sensitivity	
- Mono, 26dB S/N Ratio	<22 dBu
- Stereo, 46dB S/N Ratio	<43 dBu
Search Selectivity	>28dBf
Total Harmonic Distortion	<2%
Signal to Noise Ratio	>55 dB

AM

Tuning Range	530-1710 KHz
Tuning grid	10 KHz
Sensitivity	
- 26dB S/N Ratio	<1500 uv/m
Search Selectivity	>4000 uv/m
Total Harmonic Distortion	<3%
Signal to Noise Ratio	>45 dB

Speakers

Speaker Impedance	3 W, 4 ohm
Speaker Driver	2.5"
Sensitivity	>84dB/m/W

General information

AC power	100-240V, 50/60Hz
Operation Power Consumption	8 W
Standby Power Consumption	1 W
Dimensions	
- Main Unit (W x H x D)	368 x 99 x 293 mm
Weight	
- With Packing	2.7 kg
- Main Unit	1.8 kg

8 Troubleshooting



Warning

- Never remove the casing of this apparatus.

To keep the warranty valid, never try to repair the system yourself.

If you encounter problems when using this apparatus, check the following points before requesting service. If the problem remains unsolved, go to the Philips web site (www.philips.com/welcome). When you contact Philips, ensure that the apparatus is nearby and the model number and serial number are available.

No power

- Ensure that the AC power plug of the unit is connected properly.
- Ensure that there is power at the AC outlet.
- Ensure that the batteries are inserted correctly.

No sound

- Adjust the volume.

No response from the unit

- Disconnect and reconnect the AC power plug, then turn on the unit again.

Poor radio reception

- Increase the distance between the unit and your TV or VCR.
- Fully extend the FM antenna.

Timer does not work

- Set the clock correctly.
- Switch on the timer.

Clock/timer setting erased

- Power has been interrupted or the power plug has been disconnected.
- Reset the clock/timer.

Philips Consumer Lifestyle
A division of Philips Electronics North America Corporation
P.O. Box 10313
Stamford, CT 06904
Phone: 1-888-PHILIPS (744-5477)

Meet Philips at the Internet
<http://www.philips.com/welcome>

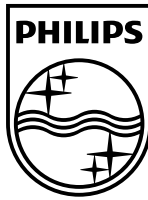

© 2010 Koninklijke Philips Electronics N.V.

All rights reserved.

Printed in China

DC6210_37_UM_V1.0

