

Homelite®

OPERATOR'S MANUAL

BACKPACKER II

UT08072 and UT08572

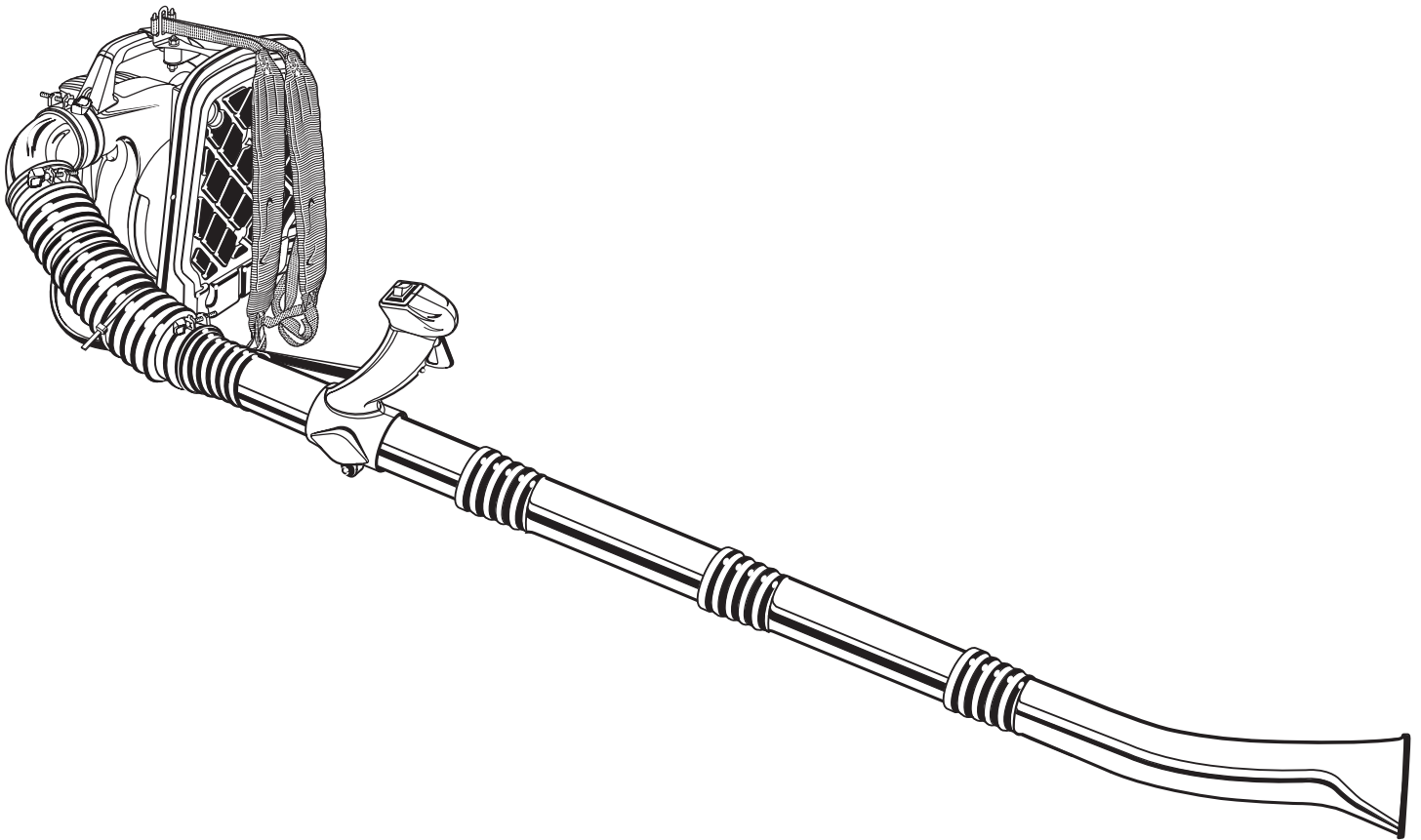

Your blower has been engineered and manufactured to Homelite's high standard for dependability, ease of operation, and operator safety. When properly cared for, it will give you years of rugged, trouble-free performance.

⚠ WARNING: To reduce the risk of injury, the user must read and understand the operator's manual before using this product.

Thank you for buying a Homelite product.

SAVE THIS MANUAL FOR FUTURE REFERENCE

TABLE OF CONTENTS

■ Introduction	2
■ General Safety Rules.....	3
■ Specific Safety Rules.....	3
■ Symbols.....	4-5
■ Features.....	6-7
■ Assembly	7-9
■ Operation.....	10-12
■ Maintenance.....	12-13
■ Accessories	13
■ Troubleshooting	14
■ Warranty	15-17
■ Parts Ordering / Service	18

INTRODUCTION

This product has many features for making its use more pleasant and enjoyable. Safety, performance, and dependability have been given top priority in the design of this product making it easy to maintain and operate.

GENERAL SAFETY RULES

WARNING:

READ AND UNDERSTAND ALL INSTRUCTIONS. Failure to follow all instructions listed below, may result in electric shock, fire and/or serious personal injury.

SAVE THESE INSTRUCTIONS







- Do not allow children or untrained individuals to use this unit.
- Never start or run the engine inside a closed area; breathing exhaust fumes can kill.
- Wear eye protection which is marked to comply with ANSI Z87.1 as well as hearing protection when operating this product.
- Keep all bystanders, children, and pets at least 50 ft. away.
- Wear heavy long pants, boots, and gloves. Do not wear loose fitting clothing, short pants, jewelry of any kind, or go barefoot.
- To reduce the risk of injury associated with objects being drawn into rotating parts, do not wear loose clothing, scarves, neck chains, and the like.
- Secure long hair so it is above shoulder level to prevent entanglement in any rotating parts.
- Do not operate this unit when you are tired, ill, or under the influence of alcohol, drugs, or medication.
- Do not operate in poor lighting.
- Keep all parts of your body away from any moving parts and all hot surfaces of the unit.
- Wear a face filter mask in dusty conditions to reduce the risk of injury associated with the inhalation of dust.
- Check the work area before each use. Remove all objects such as rocks, broken glass, nails, wire, or string which can be thrown or become entangled in the machine.
- Keep firm footing and balance. Do not overreach. Overreaching can result in loss of balance or exposure to hot surfaces.
- Never operate the unit without a spark arrestor screen; this screen is located inside the muffler.
- Product users on United States Forest Service land, and in some states, must comply with fire prevention regulations. This product is equipped with a spark arrestor; however, other user requirements may apply. Check with the federal, state, or local authorities in your area.
- Before storing, allow the engine to cool.
- Empty fuel tank and restrain the unit from moving before transporting in a vehicle.
- To reduce the risk of fire and burn injury, handle fuel with care. It is highly flammable.
- Do not smoke while handling fuel.
- Mix and store fuel in a container approved for gasoline.
- Mix fuel outdoors where there are no sparks or flames.
- Select bare ground, stop engine, and allow to cool before refueling.
- Loosen fuel cap slowly to release pressure and to keep fuel from escaping around the cap.
- Tighten the fuel cap securely after refueling.
- Wipe spilled fuel from the unit. Move 30 ft. away from refueling site before starting engine.
- Never attempt to burn off spilled fuel under any circumstances.
- Use only identical manufacturer's replacement parts and accessories. Use of any other parts may create a hazard or cause product damage.
- Maintain the unit per maintenance instructions in this Operator's Manual.
- Inspect the unit before each use for loose fasteners, fuel leaks, etc. Replace damaged parts.

SPECIFIC SAFETY RULES

- Always hold the control handle in your right hand. Refer to the Operation section later in this manual for additional instructions.
- To reduce the risk of hearing loss associated with sound level(s), hearing protection is required.
- To reduce the risk of injury associated with contacting rotating parts, stop the engine before installing or removing attachments. Always disconnect the spark plug before performing maintenance or accessing any movable parts.
- Do not point the blower nozzle in the direction of people or pets.
- Never run the unit without the proper equipment attached. Always ensure the blower tubes are installed.



SYMBOLS

Some of the following symbols may be used on this tool. Please study them and learn their meaning. Proper interpretation of these symbols will allow you to operate the tool better and safer.

SYMBOL	NAME	DESIGNATION/EXPLANATION
	Safety Alert	Precautions that involve your safety.
	Read The Operator's Manual	To reduce the risk of injury, user must read and understand operator's manual before using this product.
	Eye and Hearing Protection	Wear eye and hearing protection when operating this equipment.
	Blower Tubes	Do not operate without tubes in place.
	Long Hair	Failure to keep long hair away from the air inlet could result in personal injury.
	Loose Clothing	Failure to keep loose clothing from being drawn into air intake could result in personal injury.
	Gasoline and Oil	Use unleaded gasoline intended for motor vehicle use with an octane rating of 87 [(R + M)/2] or higher. This product is powered by a 2-cycle engine and requires pre-mixing gasoline and 2-cycle oil.

SYMBOLS

The following signal words and meanings are intended to explain the levels of risk associated with this product.

SYMBOL	SIGNAL	MEANING
	DANGER:	Indicates an imminently hazardous situation, which, if not avoided, will result in death or serious injury.
	WARNING:	Indicates a potentially hazardous situation, which, if not avoided, could result in death or serious injury.
	CAUTION:	Indicates a potentially hazardous situation, which, if not avoided, may result in minor or moderate injury.
	CAUTION:	(Without Safety Alert Symbol) Indicates a situation that may result in property damage.

SERVICE

Servicing requires extreme care and knowledge and should be performed only by a qualified service technician. For service we suggest you return the product to your nearest **AUTHORIZED SERVICE CENTER** for repair. When servicing, use only identical replacement parts.



WARNING:

To avoid serious personal injury, do not attempt to use this product until you read thoroughly and understand completely the operator's manual. Save this operator's manual and review frequently for continuing safe operation and instructing others who may use this product.



WARNING:



The operation of any power tool can result in foreign objects being thrown into your eyes, which can result in severe eye damage. Before beginning power tool operation, always wear safety goggles, safety glasses with side shields, or a full face shield when needed. We recommend Wide Vision Safety Mask for use over eyeglasses or standard safety glasses with side shields. Always use eye protection which is marked to comply with ANSI Z87.1.

SAVE THESE INSTRUCTIONS

FEATURES

PRODUCT SPECIFICATIONS

Weight	14.7 lbs.
Engine displacement.....	30cc
Air Velocity:	
MPH.....	180
CFM.....	375

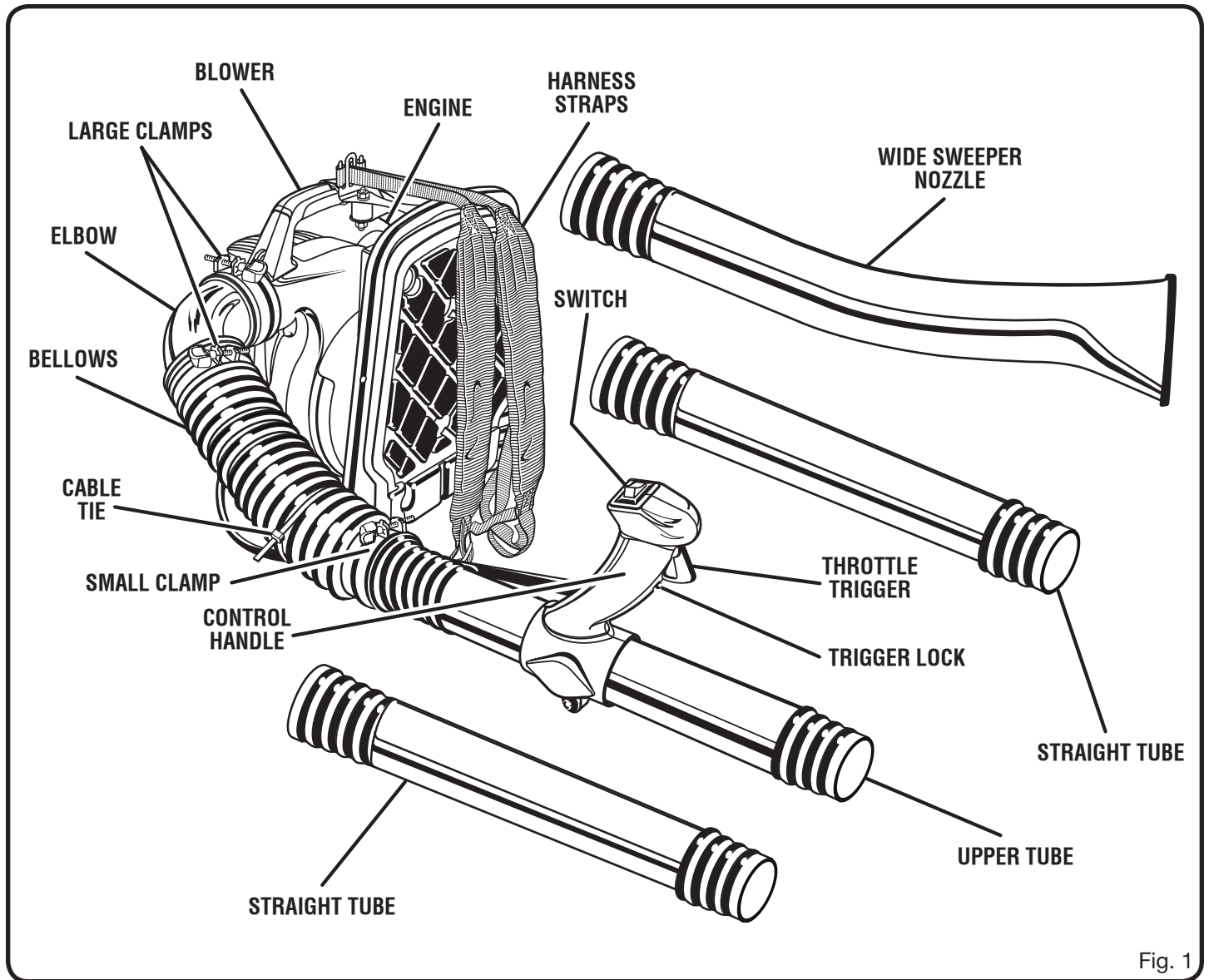

Fig. 1

FEATURES

KNOW YOUR BLOWER

See Figure 1.

Before attempting to use this product, familiarize yourself with all operating features and safety rules.

BLOWER TUBES

The blower tubes can be assembled and installed on the blower using no tools.

MOTOR

The blower has a powerful 30cc engine with sufficient power to handle tough blowing jobs.

THROTTLE TRIGGER

The blower can be operated at any speed between idle and full throttle.

TRIGGER LOCK

The trigger lock feature is used for easier starting and also allows the user to operate the blower without holding the throttle trigger. To disengage the trigger lock, simply depress the throttle trigger.

WIDE SWEEPER NOZZLE

The wide sweeper nozzle allows for more area to be covered during blower operation.

ASSEMBLY

UNPACKING

This product requires assembly.

- Carefully remove the tool and any accessories from the box. Make sure that all items listed in the packing list are included.
- Inspect the tool carefully to make sure no breakage or damage occurred during shipping.
- Do not discard the packing material until you have carefully inspected and satisfactorily operated the tool.
- If any parts are damaged or missing, please call 1-800-242-4672 for assistance.

PACKING LIST

Blower
Elbow
Bellows
Upper Tube
Large Clamps (2)
Small Clamp
Cable Tie
Straight Tubes (2)
Nozzle
Harness Straps (2)
2-Cycle Engine Oil
Operator's Manual



WARNING:

If any parts are missing do not operate this tool until the missing parts are replaced. Failure to do so could result in possible serious personal injury.



WARNING:

Do not attempt to modify this tool or create accessories not recommended for use with this tool. Any such alteration or modification is misuse and could result in a hazardous condition leading to possible serious personal injury.

NOTE: Read and remove all hang tags and store with your Operator's Manual.

ASSEMBLY

⚠ WARNING:

Disconnect the spark plug wire before assembling parts. Failure to do so could result in possible serious personal injury.

ASSEMBLING THE BLOWER TUBES

See Figures 2 - 5.

- Place large clamp on the elbow tube and install the elbow tube onto blower. Tighten large clamp securely.
- Place large clamp on the bellows and install the bellows onto the elbow. Tighten clamp securely.
- Insert upper tube into throttle control handle. Position the throttle control handle in the center of upper tube and tighten wing nut securely.

NOTE: The position of the throttle control handle may be adjusted for the best comfort after the blower is strapped onto the operator's back.

- Place small clamp on the bottom end of the bellows and install the upper tube onto the bellows; tighten clamp securely.
- Join two straight tubes, thread into the upper tube and tighten securely.
- Thread nozzle onto tube assembly and tighten securely.
- Tighten all threaded joints securely.

NOTE: Check all threaded joints after initial run to ensure they are tightened securely.

- Hold the throttle cable against the bellows and install the cable tie. Cable tie should be tight enough to retain the throttle cable to the bellows but still allow for movement.

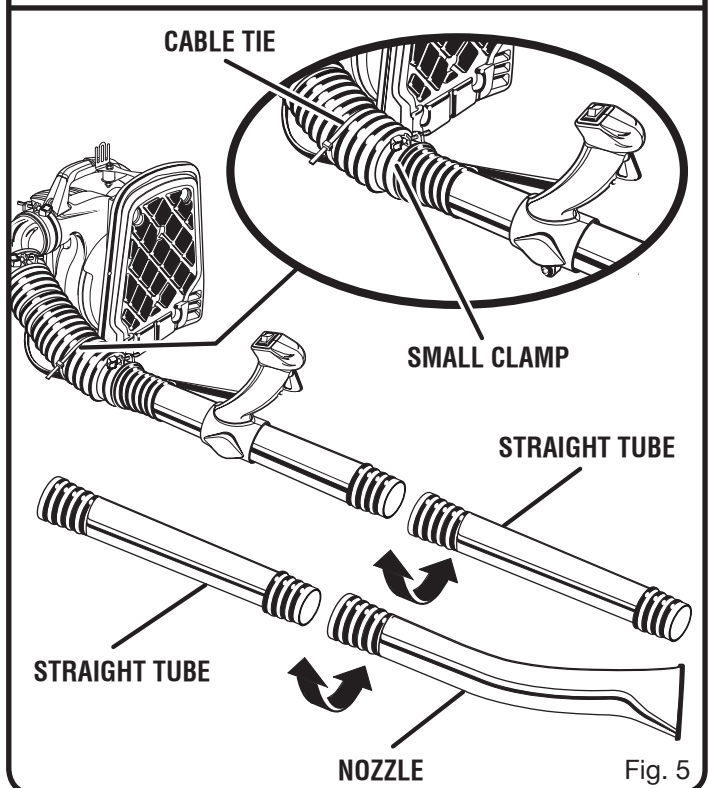
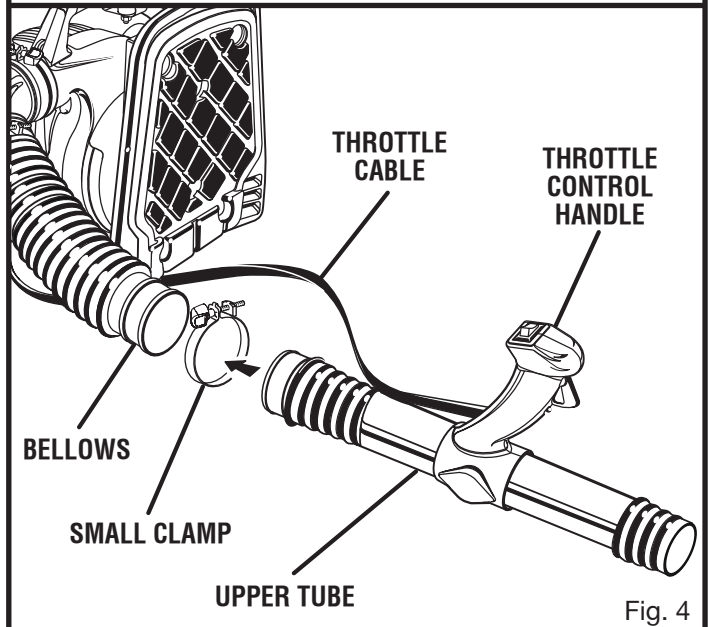
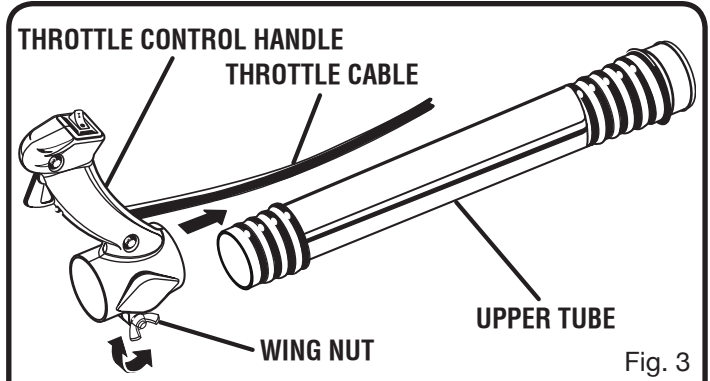
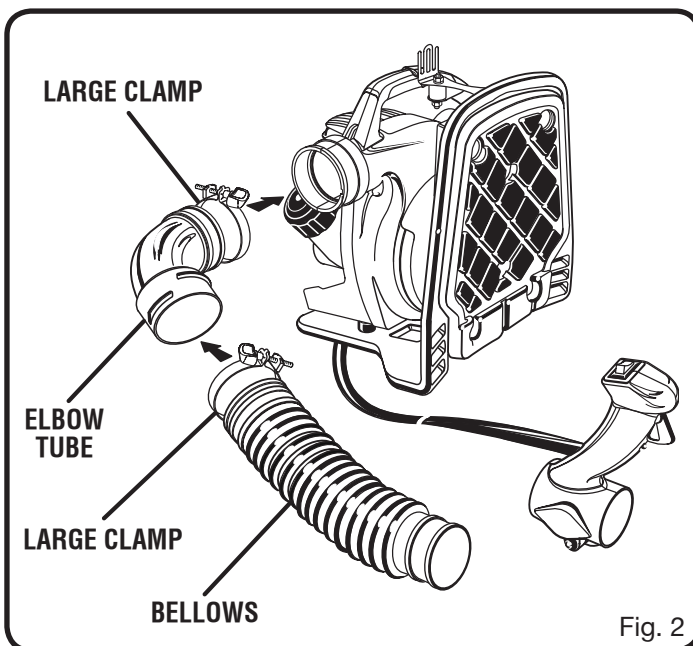

ASSEMBLY

ASSEMBLING HARNESS STRAPS

See Figures 6 - 7.

- Place short looped end of the harness strap through the top bracket. Open loop and slide onto extruded end of the bracket.
- Lace long end of the harness strap through the slot in the backpack frame.
- Thread the harness strap end through the center of buckle and then through the top toothed portion and tighten.
- Repeat steps to attach the second harness strap to the blower.

CAUTION:

Make all adjustments to the harness straps before starting the blower to avoid the possibility of injury.

ADJUSTING HARNESS STRAPS

Harness straps should be adjusted to a comfortable position before starting the blower.

To adjust the harness straps:

- Blower should be in operating position before adjusting the harness straps. Slip arm through harness strap and onto shoulder, then repeat for the other shoulder.
- Tighten or loosen each harness strap as needed, until they are adjusted to a comfortable operating position.
- Pull on harness straps to secure in buckle.

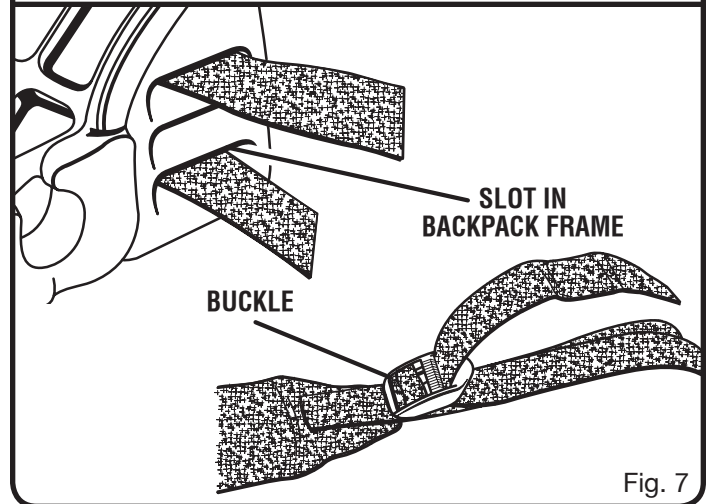
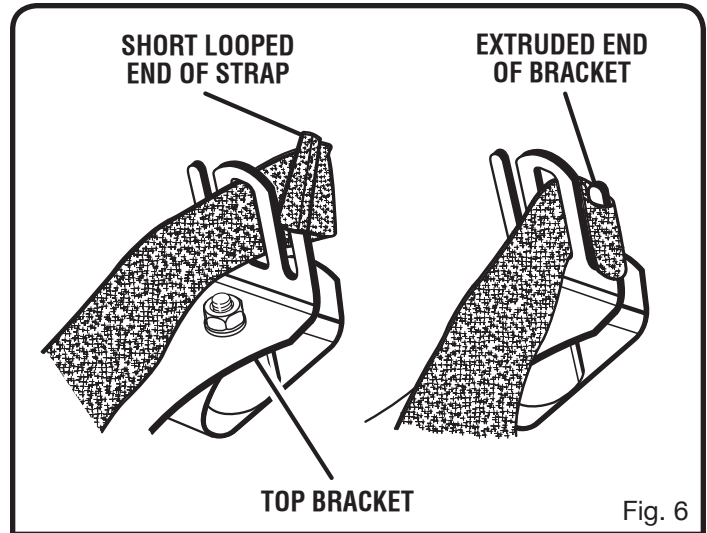

OPERATION

WARNING:

Do not allow familiarity with tools to make you careless. Remember that a careless fraction of a second is sufficient to inflict serious injury.

WARNING:

Always wear safety goggles or safety glasses with side shields when operating this tool. Failure to do so could result in objects being thrown into your eyes resulting in possible serious injury.

WARNING:

Gasoline is extremely flammable and explosive. A fire or explosion from gasoline will burn you and others.

MIXING THE FUEL

This product is powered by a 2-cycle engine and requires premixing gasoline and 2-cycle oil. The mixture should be at a 50:1 ratio, using Premium Exact Mix™ 2-cycle engine oil. If Premium Exact Mix™ 2-cycle engine oil is not available, use a high quality 2-cycle engine oil, mixed at a 50:1 ratio. See chart later in this section.

To mix the fuel:

1. Use a clean container that is approved for use with gasoline.
2. Mix the Premium Exact Mix™ 2-cycle engine oil with unleaded gasoline in the container, according to the instructions on the oil package.

This engine is certified to operate on unleaded gasoline intended for automotive use with an octane rating of 87 $([R + M] / 2)$ or higher. Do not use automotive oil or 2-cycle outboard oil.

NOTE: Premium Exact Mix™ fuel mixture will stay fresh up to 30 days. DO NOT mix quantities larger than usable in a 30 day period.

	PREMIUM EXACT MIX™ (50:1)	
	GASOLINE	OIL
	1 Gallon (US)	2.6 oz.
	1 Liter	20 cc (20 ml)

FILLING THE TANK

WARNING:

Always stop the engine before filling the fuel tank. Never add fuel to a machine with a running or hot engine. Move at least 30 ft. from the refueling area before starting engine. Do not smoke while filling the tank.

- Clean the surface around the fuel cap to prevent contamination.
- Loosen the fuel cap slowly by turning counterclockwise.
- Pour the fuel mixture carefully into the tank.
- Clean and inspect the fuel cap gasket before replacing the fuel cap.
- Replace the fuel cap and tighten it by turning it clockwise.
- Wipe spilled fuel from the product.
- Move at least 30 ft. away from refueling area before starting the product.

NOTE: It is normal for smoke to be emitted from a new engine during first use.

WARNING:

Check for fuel leaks. A leaking fuel cap is a fire hazard and must be replaced immediately. If you find any leaks, correct the problem before using the product. Failure to do so could result in a fire that could cause serious personal injury.

OPERATION

STARTING AND STOPPING

See Figures 8 - 9.

TO START:

- Place the blower on a flat, bare surface.
- Disengage the trigger lock.
- Push the primer bulb, slowly, 7 times.
- Do not engage the handle while starting.
- Set choke to START position.
- Pull the starter handle until the engine runs.
- Allow the engine to run 15 seconds, then engage the trigger to operate

TO STOP:

Release the trigger and press STOP (O) until the engine stops.

TO REMOVE BLOWER:

- Move harness straps off your shoulders and let straps slide down arms.
- Grasp the straps and lower the blower to the ground.

WARNING

Do not allow familiarity with the product to make you careless. Remember that a careless fraction of a second is sufficient to inflict severe injury.

OPERATING THE BLOWER

See Figure 10.

- Slip arm through harness strap and onto shoulder, then repeat for the other shoulder. Adjust the straps to a comfortable position. Refer to "Adjusting Harness Straps" earlier in this manual. Then remove unit for starting.
- Start the blower. Refer to "Starting and Stopping" earlier in this manual.
- Put on the blower again. The unit should be operated from the right side as shown in figure 10.
- To keep from scattering debris, blow around the outer edges of a debris pile. Never blow directly into the center of a pile.
- To reduce sound levels, limit the number of pieces of equipment used at any one time.
- Operate blower at the lowest possible throttle speed to do the job.
- Check your equipment before operation, especially the muffler, air intakes, and air filters.
- Use rakes and brooms to loosen debris before blowing. In dusty conditions, slightly dampen surfaces when water is available.

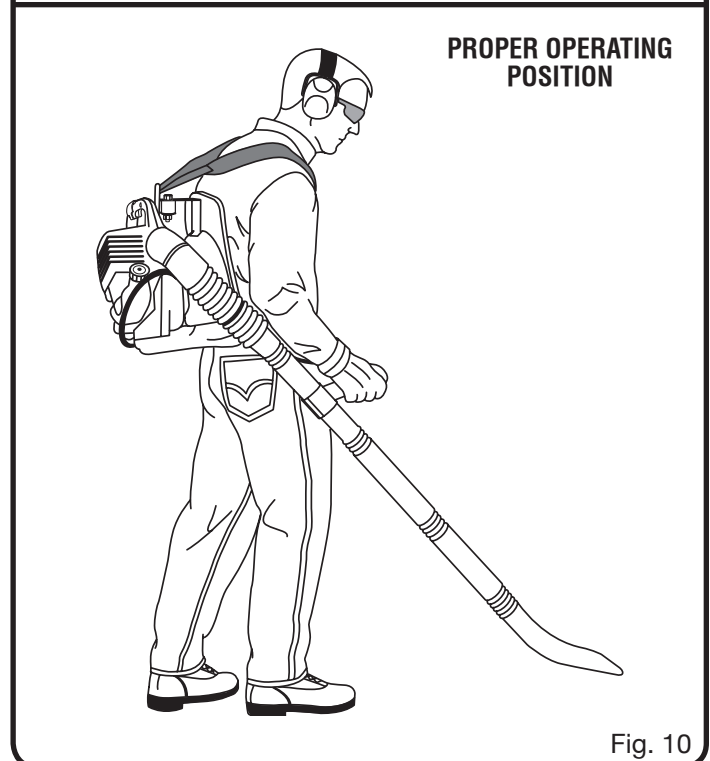
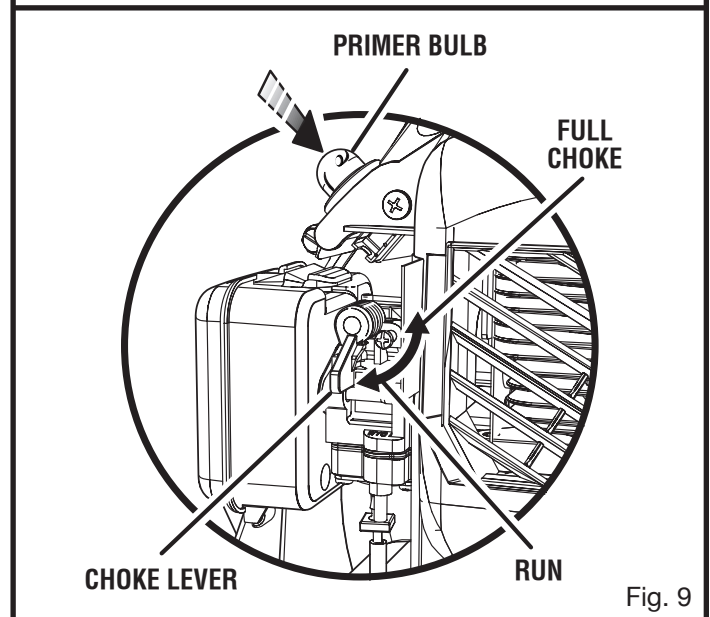
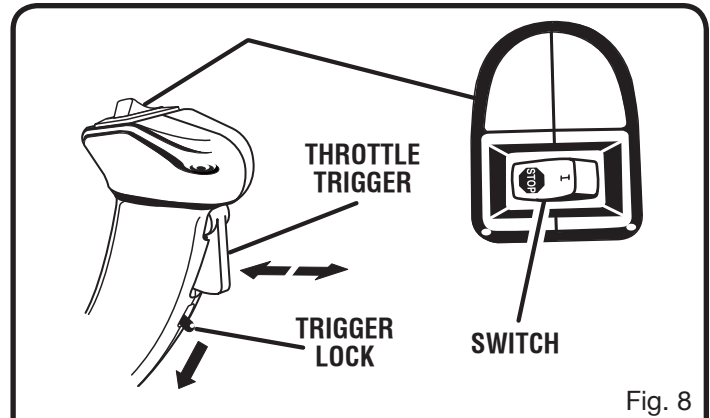

OPERATION

- Conserve water by using power blowers instead of hoses for many lawn and garden applications, including areas such as gutters, screens, patios, grills, porches, and gardens.
- Watch out for children, pets, open windows, or freshly washed cars, and blow debris safely away.
- Use the nozzle for larger volume, so the air stream can work close to the ground.
- After using blowers or other equipment, CLEAN UP! Dispose of debris properly.

MAINTENANCE

⚠ WARNING:

When servicing, use only identical Homelite replacement parts. Use of any other parts may create a hazard or cause product damage.

⚠ WARNING:

Always wear safety goggles or safety glasses with side shields during power tool operation or when blowing dust. If operation is dusty, also wear a dust mask.

GENERAL MAINTENANCE

Avoid using solvents when cleaning plastic parts. Most plastics are susceptible to damage from various types of commercial solvents and may be damaged by their use. Use clean cloths to remove dirt, dust, oil, grease, etc.

⚠ WARNING:

Do not at any time let brake fluids, gasoline, petroleum-based products, penetrating oils, etc., come in contact with plastic parts. Chemicals can damage, weaken or destroy plastic which may result in serious personal injury.

LUBRICATION

All of the bearings in this tool are lubricated with a sufficient amount of high grade lubricant for the life of the unit under normal operating conditions. Therefore, no further lubrication is required.

REPLACING AND CLEANING THE AIR FILTER

See Figure 11.

For proper performance and long life, keep air filter clean.

- Pivot the air filter cover down by pushing down on the latch with your thumb while gently pulling on the cover.
- Remove the filter. Clean it in warm soapy water. Rinse and let dry completely. For best performance, replace annually.
- Install the filter. Pivot the cover into place ensuring the latch snaps and latches into place.

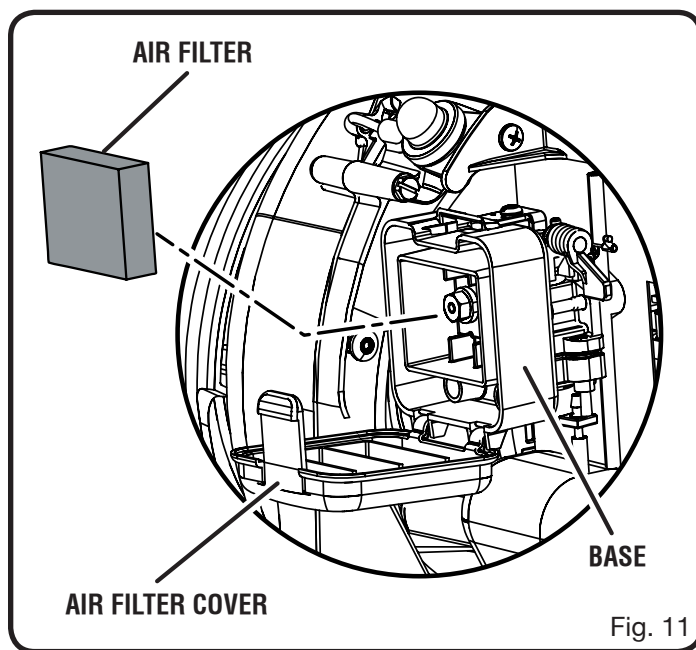

Fig. 11

MAINTENANCE

SPARK ARRESTOR

The muffler is equipped with a spark arrestor screen inside the muffler body. After extended use the screen can become dirty; you may need to have the muffler replaced by an authorized servicing dealer.

WARNING:

Never run the blower without the spark arrestor in place. Failure to do so could result in a fire that could cause serious personal injury.

CLEANING THE EXHAUST PORT AND MUFFLER

Depending on the type of fuel used, the type and amount of oil used, and/or your operating conditions, the exhaust port and muffler may become blocked with carbon deposits. If you notice low power from the blower, have a qualified service technician check the exhaust port and muffler for carbon deposits. Removing the carbon deposits should restore performance to the blower.

FUEL CAP

WARNING:

A leaking fuel cap is a fire hazard and must be replaced immediately. Failure to do so could result in a fire that could cause serious personal injury.

The fuel cap contains a non-serviceable filter and a check valve. A clogged fuel filter will cause poor engine performance. If performance improves when the fuel cap is loosened, the check valve may be faulty or filter clogged. Replace the fuel cap if required.

SPARK PLUG

This engine uses a Champion RCJ-6Y with 0.63 mm (0.025 in.) electrode gap. Use an exact replacement part and replace annually.

WARNING:

Be careful not to cross-thread the spark plug. Cross-threading will seriously damage the product.

STORAGE (1 MONTH OR LONGER)

- Drain all fuel from the tank into a container approved for gasoline. Run engine until it stops.
- Clean all foreign material from the blower. Store it in a well-ventilated place that is inaccessible to children. Keep away from corrosive agents such as garden chemicals and de-icing salts.
- Abide by all Federal and local regulations for the safe storage and handling of gasoline. Excess fuel should be used up in other 2-cycle engine powered equipment.

ACCESSORIES

The following recommended accessories are currently available at retail stores.

Air Filter (Power Care).....	AP04107
Spark Plug (Champion)	RCJ-6Y
2-Cycle Oil (Homelite).....	AH99G01
Fuel Cap (Power Care)	AP04108

WARNING:

Current attachments and accessories available for use with this product are listed above. Do not use any attachments or accessories not recommended by the manufacturer of this product. The use of attachments or accessories not recommended can result in serious personal injury.

TROUBLESHOOTING

IF THESE SOLUTIONS DO NOT SOLVE THE PROBLEM CONTACT YOUR AUTHORIZED SERVICING DEALER.

PROBLEM	POSSIBLE CAUSE	SOLUTION
Engine will not start.	<ol style="list-style-type: none"> 1. No spark. 2. No fuel. 3. Starter rope pulls harder now than when new. 	<ol style="list-style-type: none"> 1. Check spark. Remove spark plug. Reattach the spark plug cap and lay spark plug on metal cylinder. Pull the starter rope and watch for spark at spark plug tip. If there is no spark, repeat test with a new spark plug. 2. Push primer bulb until fuel is visible in the bulb. If fuel is not apparent, the primary fuel delivery system is blocked. Contact a servicing dealer. If primer bulb fills, engine may be flooded (see next item). 3. Contact a servicing dealer.
Engine starts but will not accelerate.	Carburetor requires "L" (Low jet) adjustment.	Contact a servicing dealer for carburetor adjustment.
Engine starts but will only run at high speed at half choke.	Carburetor requires "H" (High jet) adjustment.	Contact a servicing dealer for carburetor adjustment.
Engine does not reach full speed and emits excessive smoke.	<ol style="list-style-type: none"> 1. Oil / fuel mixture is incorrect. 2. Air filter is dirty. 3. Spark arrestor screen is dirty. 4. Carburetor requires adjustment. 	<ol style="list-style-type: none"> 1. Use fresh fuel and the correct 2-cycle oil mix. 2. Clean air filter, refer to "Replacing and Cleaning the Air Filter" earlier in this manual. 3. Contact a servicing dealer. 4. Contact a servicing dealer for carburetor adjustment.
Engine starts, runs, and accelerates, but will not idle.	Idle speed adjustment screw on carburetor needs adjustment.	Turn idle speed adjustment screw clockwise to increase idle speed. <i>See Figure 12.</i>

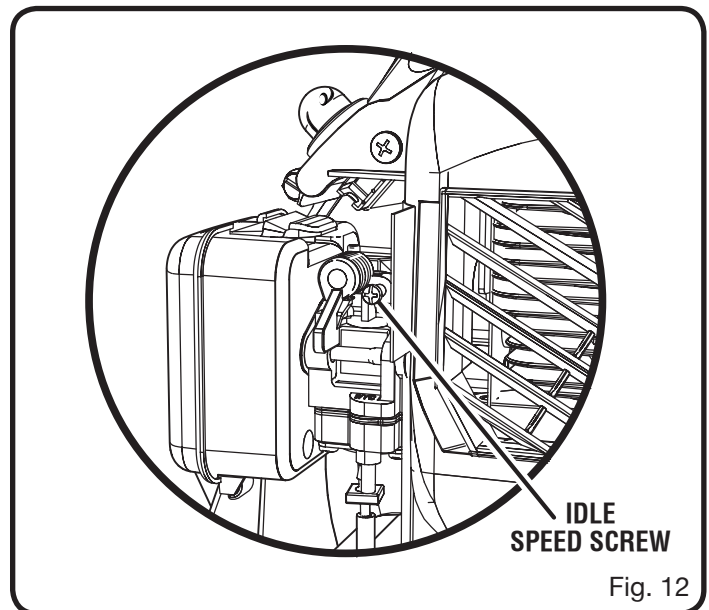

Fig. 12

WARRANTY

LIMITED WARRANTY STATEMENT

Homelite Consumer Products, Inc. warrants to the original retail purchaser that this **HOMELITE** product is free from defect in material and workmanship and agrees to repair or replace, at Homelite Consumer Products, Inc.'s discretion, any defective product free of charge within these time periods from the date of purchase.

- One year for the following units: Yard Broom, Trimlite and Bandit;
- Two years if the product is used for personal, family or household use;
- 90 days, if used for any other purpose, such as commercial or rental.

This warranty extends to the original retail purchaser only and commences on the date of the original retail purchase.

Any part of the **HOMELITE** product manufactured or supplied by **HOMELITE** and found in the reasonable judgment of **HOMELITE** to be defective in material or workmanship will be repaired or replaced by an authorized **HOMELITE** service dealer without charge for parts and labor.

The product, including any defective part, must be returned to an authorized service dealer within the warranty period. The expense of delivering the **HOMELITE** product to the dealer for warranty work and the expense of returning it back to the owner after repair or replacement will be paid by the owner. **HOMELITE'S** responsibility in respect to claims is limited to making the required repairs or replacements and no claim of breach of warranty shall be cause for cancellation or rescission of the contract of sale of any **HOMELITE** product. Proof of purchase will be required by the dealer to substantiate any warranty claim. All warranty work must be performed by an authorized **HOMELITE** service dealer.

This warranty is limited to ninety (90) days from the date of original retail purchase for any **HOMELITE** product that is used for rental or commercial purposes, or any other income-producing purpose.

This warranty does not cover any **HOMELITE** product that has been subject to misuse, neglect, negligence, or accident, or that has been operated in any way contrary to the operating instructions as specified in this operator's manual. This warranty does not apply to any damage to the **HOMELITE** product that is the result of improper maintenance or to any **HOMELITE** product that has been altered or modified. The warranty does not extend to repairs made necessary by normal wear or by the use of parts or accessories which are either **INCOMPATIBLE WITH THE HOMELITE** product or adversely affect its operation, performance, or durability.

In addition, this warranty does not cover:

- A. Tune-ups – Spark Plugs, Carburetor, Carburetor Adjustments, Ignition, Filters
- B. Wear items – Bump Knobs, Outer Spools, Cutting Lines, Inner Reels, Starter Pulleys, Starter Ropes, Drive Belts, Tines, Felt Washers, Hitch Pins, Mulching Blades, Blower Fans, Blower and Vacuum Tubes, Vacuum Bags and Straps, Guide Bars, Saw Chains

HOMELITE reserves the right to change or improve the design of any **HOMELITE** product without assuming any obligation to modify any product previously manufactured.

ALL IMPLIED WARRANTIES ARE LIMITED IN DURATION TO THE STATED WARRANTY PERIOD. ACCORDINGLY, ANY SUCH IMPLIED WARRANTIES INCLUDING MERCHANTABILITY, FITNESS FOR A PARTICULAR PURPOSE, OR OTHERWISE, ARE DISCLAIMED IN THEIR ENTIRETY AFTER THE EXPIRATION OF THE APPROPRIATE TWO-YEAR, ONE-YEAR, OR NINETY DAY WARRANTY PERIOD. **HOMELITE'S** OBLIGATION UNDER THIS WARRANTY IS STRICTLY AND EXCLUSIVELY LIMITED TO THE REPAIR OR REPLACEMENT OF DEFECTIVE PARTS AND **HOMELITE** DOES NOT ASSUME OR AUTHORIZE ANYONE TO ASSUME FOR THEM ANY OTHER OBLIGATION. SOME STATES DO NOT ALLOW LIMITATIONS ON HOW LONG AN IMPLIED WARRANTY LASTS, SO THE ABOVE LIMITATION MAY NOT APPLY TO YOU. **HOMELITE** ASSUMES NO RESPONSIBILITY FOR INCIDENTAL, CONSEQUENTIAL, OR OTHER DAMAGES INCLUDING, BUT NOT LIMITED TO, EXPENSE OF RETURNING THE **HOMELITE** PRODUCT TO AN AUTHORIZED SERVICE DEALER AND EXPENSE OF DELIVERING IT BACK TO THE OWNER, MECHANIC'S TRAVEL TIME, TELEPHONE OR TELEGRAM CHARGES, RENTAL OF A LIKE PRODUCT DURING THE TIME WARRANTY SERVICE IS BEING PERFORMED, TRAVEL, LOSS OR DAMAGE TO PERSONAL PROPERTY, LOSS OF REVENUE, LOSS OF USE OF THE PRODUCT, LOSS OF TIME, OR INCONVENIENCE. SOME STATES DO NOT ALLOW THE EXCLUSION OR LIMITATION OF INCIDENTAL OR CONSEQUENTIAL DAMAGES, SO THE ABOVE LIMITATION OR EXCLUSION MAY NOT APPLY TO YOU.

This warranty gives you specific legal rights, and you may also have other rights which vary from state to state.

This warranty applies to all **HOMELITE** products manufactured by **HOMELITE** and sold in the United States and Canada.

To locate your nearest service dealer, dial 1-800-242-4672 or log on to our website at www.homelite.com.

WARRANTY

THE FOLLOWING CALIFORNIA AIR RESOURCES BOARD (CARB) STATEMENT ONLY APPLIES TO MODEL NUMBERS REQUIRED TO MEET THE CARB REQUIREMENTS.

HOMELITE CONSUMER PRODUCTS, INC., LIMITED WARRANTY FEDERAL AND CALIFORNIA EMISSION CONTROL SYSTEMS NONROAD AND SMALL OFF-ROAD ENGINES

The U.S. Environmental Protection Agency (EPA), the California Air Resources Board (CARB), and Homelite Consumer Products, Inc. are pleased to explain the Emission Control System Warranty on your nonroad or small off-road engine. In California, new small off-road engines must be designed, built, and equipped to meet the state's stringent anti-smog standards. In other states, new 2000 and later model year nonroad engines must be designed, built, and equipped at the time of sale to meet the U.S. EPA regulations for small nonroad engines. The nonroad engine must be free from defects in materials and workmanship which cause it to fail to conform with U.S. EPA standards for the first two years of engine use from the date of sale to the ultimate purchaser. Homelite Consumer Products, Inc. must warrant the emission control system on your nonroad or small off-road engine for the period of time listed above provided there has been no abuse, neglect, or improper maintenance of your nonroad or small off-road engine.

Your emission control system may include parts such as the carburetor or fuel injection system, the ignition system, and the catalytic converter. Also included may be hoses, belts and connectors, and other emission-related assemblies.

Where a warrantable condition exists, Homelite Consumer Products, Inc. will repair your nonroad or small off-road engine at no cost to you, including diagnosis (if the diagnostic work is performed at an authorized dealer), parts, and labor.

MANUFACTURER'S WARRANTY COVERAGE:

The 1995 and later small off road engines are warranted for two years in California. In other states, 1997 and later model year nonroad engines are also warranted for two years. If any emission-related part on your engine is defective, the part will be repaired or replaced by Homelite Consumer Products, Inc. free of charge.

OWNER'S WARRANTY RESPONSIBILITIES

- (a) As the nonroad or small off-road engine owner, you are responsible for the performance of required maintenance listed in your operator's manual. Homelite Consumer Products, Inc. recommends that you retain all receipts covering maintenance on your nonroad or small off-road engine, but Homelite Consumer Products, Inc., cannot deny warranty solely for the lack of receipts or for your failure to ensure the performance of all scheduled maintenance. Any replacement part or service that is equivalent in performance and durability may be used in non-warranty maintenance or repairs, and shall not reduce the warranty obligations of the engine manufacturer.
- (b) As the nonroad or small off-road engine owner, you should be aware, however, that Homelite Consumer Products, Inc., may deny you warranty coverage if your nonroad or small off-road engine or a part has failed due to abuse, neglect, improper maintenance, or unapproved modifications.
- (c) You are responsible for presenting your nonroad or small off-road engine to a Homelite Consumer Products, Inc., service dealer as soon as a problem exists. The warranty repairs should be completed in a reasonable amount of time, not to exceed 30 days.

If you have any questions regarding your warranty rights and responsibilities, you should contact a Homelite Consumer Products, Inc., Customer Representative at 1-800-242-4672.

COVERAGE:

Homelite Consumer Products, Inc. warrants to the ultimate purchaser and each subsequent purchaser that your nonroad or small off-road engine will be designed, built, and equipped at the time of sale to meet all applicable regulations. Homelite Consumer Products, Inc. also warrants to the initial purchaser and each subsequent purchaser that your nonroad or small off-road engine is free from defects in materials and workmanship which cause the engine to fail to conform with applicable regulations for a period of two years. The 1995 and later small off road engines are warranted for two years in California. In all other states for 1997 and later model years, EPA requires manufacturers to warrant non-road engines for two years. These warranty periods will begin on the date the nonroad or small off-road engine is purchased by the initial purchaser. If any emission-related part on your engine is defective, the part will be replaced by Homelite Consumer Products, Inc. at no cost to the owner.

Homelite Consumer Products, Inc. shall remedy warranty defects at any authorized Homelite Consumer Products, Inc. engine dealer or warranty station. Any authorized work done at an authorized dealer or warranty station shall be free of charge to the owner if such work determines that a warranted part is defective. Any manufacturer-approved or equivalent replacement part may be used for any warranty maintenance or repairs on emission-related parts, and must be provided free of charge to the owner if the part is still under warranty. Homelite Consumer Products, Inc. is liable for damages to other engine components caused by the failure of a warranted part still under warranty.

The California Air Resources Board's Emission Warranty Parts List specifically defines the emission-related warranted parts. (EPA's regulations do not include a parts list, but EPA considers emission-related warranted parts to include all the parts listed below.)

These warranted parts are: Carburetor, Spark Plug, Ignition, Air Filter, and Fuel Filter.

MAINTENANCE REQUIREMENTS

The owner is responsible for the performance of the required maintenance as defined by Homelite Consumer Products, Inc. in the operator's manual.

LIMITATIONS

The Emission Control Systems Warranty shall not cover any of the following:

- (a) repair or replacement required because of misuse or neglect, lack of required maintenance, repairs improperly performed, or replacements not conforming to Homelite Consumer Products, Inc. specifications that adversely affect performance and/or durability, and alterations or modifications not recommended or approved in writing by Homelite Consumer Products, Inc., and
- (b) replacement of parts and other services and adjustments necessary for required maintenance at and after the first scheduled replacement point.

The Emissions Compliance Period referred to on the Emissions Compliance label indicates the number of operating hours for which the engine has been shown to meet Federal emission requirements. Category C=50 hours, B=125 hours, and A=300 hours.

WARRANTY

THIS PRODUCT WAS MANUFACTURED WITH A CATALYST MUFFLER

Congratulations! You have made an investment toward protecting the environment. In order to maintain this product's original emission level, please refer to the maintenance section below.

EMISSIONS MAINTENANCE SCHEDULE AND WARRANTED PARTS LIST

Emissions Parts	Inspect Before Each Use	Clean Every 5 Hours	Replace Every 25 Hours or Yearly	Clean Every 25 Hours or Yearly	Replace Every 50 Hours
CATALYTIC MUFFLER ASSEMBLY					X
AIR FILTER ASSY					
includes:					
Filter		X	X		
SPARK SCREEN					X
CARBURETOR ASSY					
includes:					
Heat Dam					
Gaskets					
FUEL TANK ASSY					
includes:					
Fuel Lines			X		
Fuel Cap			X		
Fuel Filter					
IGNITION ASSY					
includes:					
Spark Plug			X		
ALL EMISSIONS RELATED PARTS ARE WARRANTED FOR TWO YEARS OR FOR THE PERIOD OF TIME PRIOR TO THE PARTS FIRST SCHEDULED REPLACEMENT WHICHEVER COMES FIRST.					



CALL US FIRST

For any questions about operating or maintaining your product,
call the Homelite® Help Line!

Your product has been fully tested prior to shipment to ensure
your complete satisfaction.

