

TEFAL



STEAM CUISINE 700 TURBO DIFFUSION
STEAM CUISINE 1000 TURBO DIFFUSION

**GEbruiksaanwijzing • INSTRUCTIONS FOR USE • BRUGSANVISNING
ANVÄNDNING • BRUKSANVISNING**

INHOUDSOPGAVE

Beschrijving van het apparaat	blz. 4	Onderhoud en schoonmaken	blz. 7
Vóór het eerste gebruik	blz. 4	Stoomtijdentabellen	blz. 8
Gebruiksaanwijzing	blz. 4	Veiligheidsvoorschriften	blz. 11

CONTENTS

Description of the appliance	P. 12	Cleaning and maintenance	P. 15
Before use	P. 12	Table of cooking times	P. 16
Instructions for use	P. 12	Safety instructions	P. 19

INDHOLDSFORTEGNELSE

Dampkogerens opbygning	s. 20	Rengøring og vedligeholdelse	s. 23
Inden du tager dampkogerens i brug første gang	s. 20	Oversigt over kogetider	s. 24
Brugsanvisning	s. 20	Sikkerhedsadvarsler	s. 27

INNEHÅLL

Ångkokarens olika delar	s. 28	Rengöring och underhåll	s. 31
Innan användning	s. 28	Tillagningstider	s. 32
Användning	s. 28	Säkerhetsföreskrifter	s. 35

INDHOLDSFORTEGNELSE

Beskrivelse av apparatet	s. 36	Rengjøring og vedlikehold	s. 39
Før første gangs bruk	s. 36	Tebell med koketider	s. 41
Brukerveiledning	s. 36	Sikkerhetsinstruksjoner	s. 44

STEAM CUISINE 700 TURBO DIFFUSION
STEAM CUISINE 1000 TURBO DIFFUSION

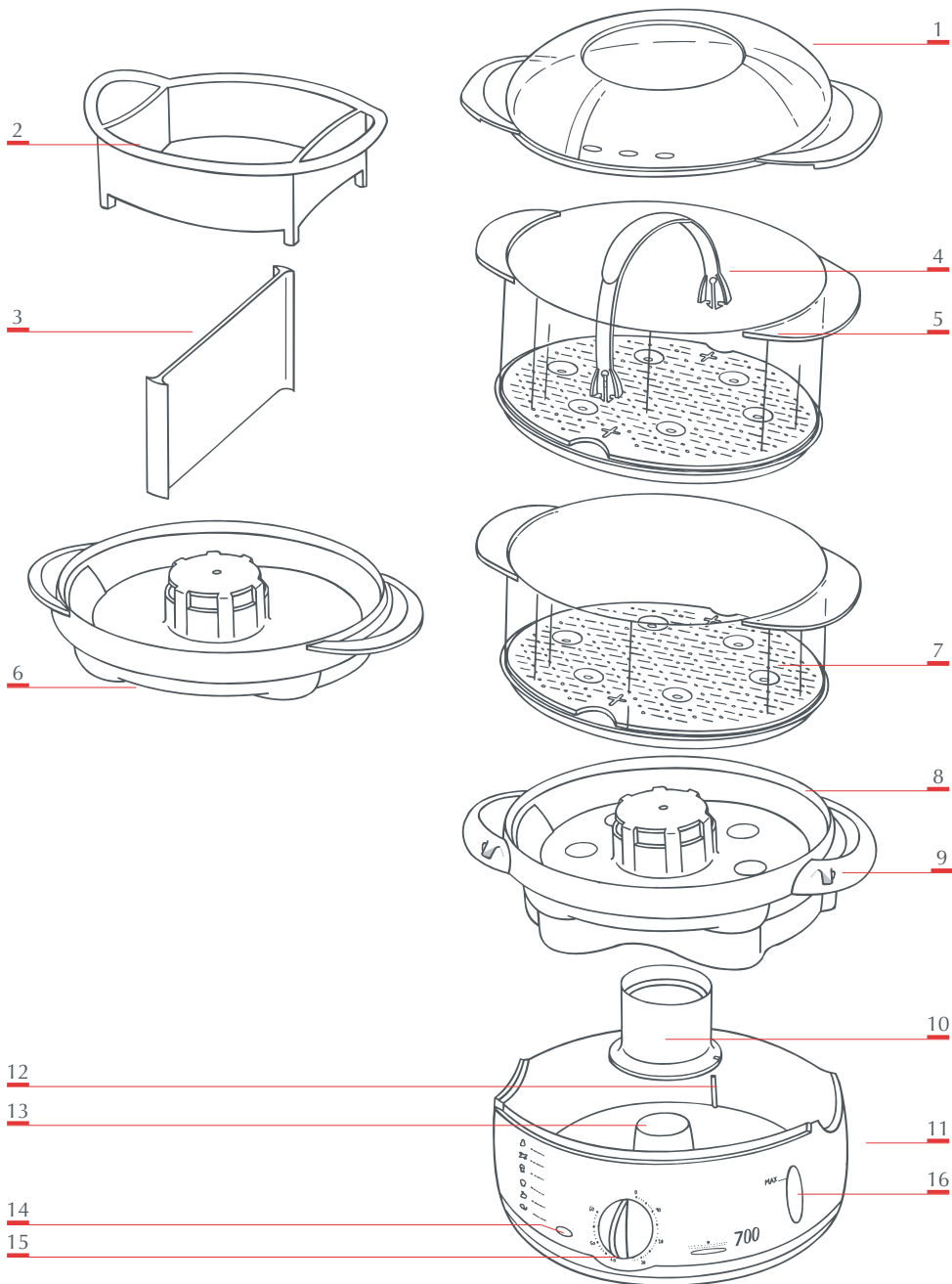

Your steam cooker can be used to prepare excellent food, with ease. It is ideal for families who wish to eat a healthy diet, and can be used to cook nutritious dishes without any added fats. This reduces the calories and preserves the vitamins. It may be used to cook all types of food : vegetables, fruit, fish, meat, rice, etc.

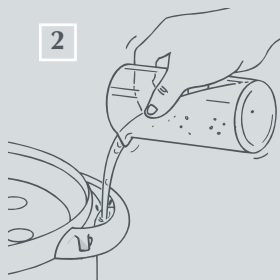
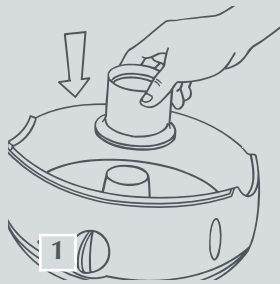

Description of the appliance

- 1 Lid
- 2 Rice bowl
- 3 Separator (depending on model)
- 4 Clip-on handle
- 5 Large steam bowl (4 L) and removable grids with integral egg holder (models 6162 and 6163)
- 6 Separator / juice tray (depending on model)
- 7 Small steam bowl (3 L) and removable grids with integral egg holder (1 with model 6162 and 2 with model 6163)
- 8 Juice collector with integral egg holder
- 9 Openings for filling with water 
- 10 Removable turbo ring
- 11 Base / water reservoir (capacity 1 litre, lasts 1 hour)
- 12 Maximum level for filling
- 13 Heating element
- 14 On indicator
- 15 Timer
- 16 Water level indicator

Before use

Read the instructions for use and follow them carefully.

Unpacking the appliance.

- Remove the appliance from its packaging and unpack all the accessories. Wash the lid, rice bowl, steam cooking

bowls, removable grids, Clip-on handle, juice collector and separator / juice tray (depending on the model) with warm soapy water.

- Rinse and dry. Wash the water reservoir in the same way.

Instructions for use

Operation

- Place the base of the appliance on a stable surface, away from any objects which could be damaged by steam.

- Put the turbo ring in position around the heating element - **Fig. 1**

Filling the water reservoir

To fill the water reservoir, there are two possible methods:

- **Method 1:** pour cold water into the water reservoir through the filling openings until the maximum level is reached - **Fig. 2**
- **Method 2:** pour cold water directly into the water reservoir and heating element housing until the maximum level is reached - **Fig. 3**

Caution: never put any seasoning or liquid other than water into the water reservoir.

- Place the juice collector on the base and check that it is level.

Caution: make sure you check that there is water in the reservoir before switching on.

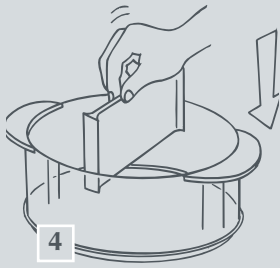

Use of the various elements

Single bowl model

- Place the food in the bowl.
- If you wish to cook different types of food at the same time, you can use the food separator (depending on model). Place it in the centre of the bowl - **Fig. 4**
- Put the food into each compartment.
- Place the bowl onto the juice collector.

Use of several steam bowls at the same time

- It is possible to put different food items in each bowl, but make sure that their flavours complement each other.
- It is also possible (depending on model) to put the juice tray / separator between the bowls. This avoids mixing the cooking juices from each bowl. In this way you can cook different items of food whilst conserving their flavour.

Use of removable grids - Fig. 5

- The bowls are fitted with removable grids which increase the volume of the cooking area and can be used to cook large items of food (whole chickens, kebabs, artichokes, lobsters, etc).

To put the grids in position - Fig. 6

- Take the grid the right way up (clip facing downwards).

Model with more than one bowl.

The bowls and grids can be assembled in any order.

- Place the food in the bowls. We recommend that you put the largest pieces of food, requiring the longest cooking time, in the lowest bowl.
- Place the bowls onto the juice collector.

- If you are cooking food with different cooking times, start cooking in the lower bowl with the food requiring a longer cooking time. When the timer reaches the setting for cooking the food which requires a shorter cooking time, remove the lid using a cloth, and put the higher bowl in position. Close and continue cooking.

To remove the grids - Fig. 7

- To unclip the grid, press on the top from the outside.

Caution: the bowl placed on the juice collector must always have its grid fitted.

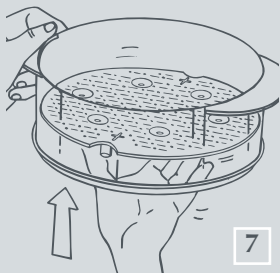
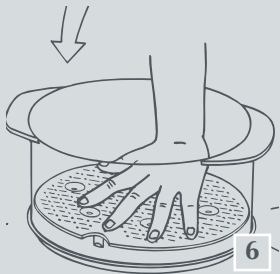
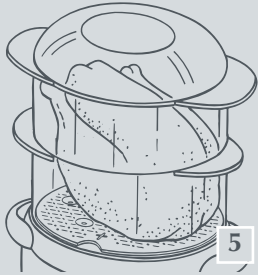

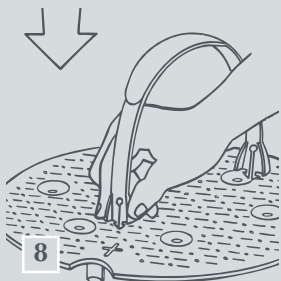

8

Use of the Clip-on handle.

The Clip-on handle has been specially designed so that food can easily be removed from the bowl without damaging it. This preserves the appearance of the food, for better presentation (fish, asparagus, etc.).

- Place the grid right side up (with the hooks underneath).
- Pick up the handle with the rounded side uppermost.

- Grip the end of the handle - **Fig. 8**
 - Insert the end into the cross on the grid and release
 - Repeat the operation on the other side.
- Caution: The Clip-on handle can be equally used in the bowls. However, the bowl using a clip-on handle must necessarily be equipped with a lid.**

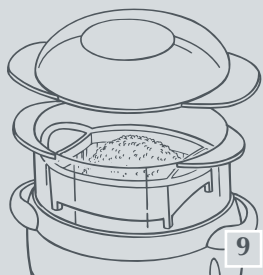

9

Use of the rice bowl

- Place a bowl on the juice collector.
- Put one volume of rice and one and a half volumes of water into the rice bowl (maximum 300 grams of rice).

- Put the rice bowl into the steam bowl - **Fig. 9**
- Place the lid on top.

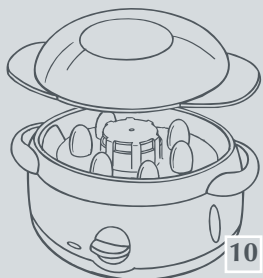

10

Instructions for using your steamer

Thanks to its removable grid, your steamer adapts to every recipe. A pictogram will help you assemble the different bowls in the best way.



1 steaming bowl with grid



2 steaming bowls with grid + rice bowl



1 steaming bowl without grid + 1 steaming bowl with grid



1 steaming bowl with grid + rice bowl



Clip-it handle



2 steaming bowls with grid



the base with the juice collector



and the lid

Remember, however, that for all recipes you will need:



11

Cooking eggs

To cook up to 6 eggs - Fig. 10

- Place the eggs directly into the juice collector using the specially shaped holders provided for this purpose.
- Place the lid on top.

To cook more than 6 eggs

- Use the steam bowls as well as the juice collector.
- Put the eggs on the grids using the specially shaped holders provided for this purpose.
- Place the lid on top.

Switching on

Caution: make sure that the appliance is correctly assembled before use. Use only the special containers designed for the appliance.

- Plug in.
- Set the timer to the recommended cooking time.

- The on indicator lights up, and steam cooking begins - **Fig. 11**

Caution: the appliance must be plugged in before setting the timer, since the timer operates even when the appliance is not plugged in.

- When the cooking time is up, the timer rings and the light goes out.

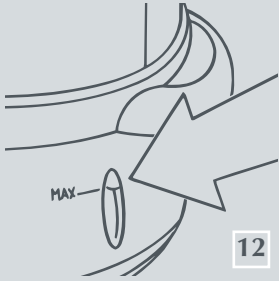

12

During cooking

- The water level indicator is used to check on the level of water during cooking - **Fig. 12**
- The openings for filling have been designed so that the water can be topped up at any time during cooking without having to move the bowls.

Caution: for food which releases a lot of water during cooking (e.g. frozen vegetables, asparagus, etc.) it may be necessary to empty the juice collector(s) during the cooking time.

When cooking is finished

- Remove the lid carefully. Avoid placing face in direct contact with escaping steam.
- To avoid food becoming overcooked, remove the steam bowl using a cloth and place it on a plate.
- If you used the rice bowl, remove it carefully by the handles.

- If you used the Clip-on handle, remove the Clip-on handle and removable grid carefully, using an oven glove.

Caution: before removing the juice collector, check that the whole appliance has cooled down sufficiently.

- After use, unplug the appliance and leave it to cool down completely before putting it away.

Cleaning and maintenance

- Do not use abrasive cleaning products or solvents.

Cleaning the base / water reservoir

- Do not immerse the base of the product in water.
- Use a damp cloth.
- Wash the water reservoir with soapy water.

- Clean the turbo ring, and the notch which lets the water through, regularly.
- Empty the reservoir and refill the appliance with fresh water before each use.

Cleaning the plastic accessories

- The steam bowls are easily cleaned, thanks to their removable base.
- Do not clean the plastic bowls with the scourer side of a sponge.

- Plastic accessories can be washed in the dishwasher.

Descaling

After using the appliance 7 to 10 times, scale may form on the heating element, depending on the hardness of the water used. **It is recommended to descale the appliance regularly, so that steam formation is not impeded, and also to prolong the life of your appliance.**

- Fill the water reservoir and the heating element housing with a solution of half water and half white vinegar to the maximum level mark. Do not use other descaling products.
- Plug in. The juice collector, juice tray / separator (depending on model), turbo

ring, steam bowls, lid and rice bowl are not used during this operation.

- Set the timer to 20-25 minutes. If the vinegar solution boils over, stop the timer and unplug the appliance.
- When the timer rings, unplug the appliance and wait for it to cool down before emptying out the vinegar solution.
- Rinse the reservoir with clear water several times.
- Check that water flows correctly between the reservoir and the heating element housing.

Some recommendations

- If you so wish you can reduce cooking times significantly by filling the reservoir with warm water, but note that cooking times given in the recipes are for use with cold water.
- Do not pack food too tightly in the steam bowls or rice bowl. Leave some space for steam to circulate as much as possible.
- The times indicated may vary depending on the size of pieces of food, the space left between items, the quality of food used and individual taste. Once

you are familiar with the appliance, you will be able to adjust these times. For best results, use pieces of food of approximately the same size. If the pieces are of different sizes, and need to be put in layers, put the smallest pieces on top.

- If you are steaming large quantities of food, remove the lid halfway through the cooking time, stir the food and put the lid back on. Avoid placing face in direct contact with the steam.
- Use the juice collected in the juice accessory to make soups, sauces, etc.

Table of cooking times

Fish • Seafood

Food	Type	Quantity	Cooking time	Recommendations
Shellfish	Fresh	250/400 g	8-10 min.	Cooking is finished when the shells are open
Prawns	Fresh	400 g	6 min.	Stir halfway through cooking
Mussels	Fresh	400 g	8-10 min.	Stir halfway through cooking
Saint-Jacques	Fresh Flesh	400 g	10 min.	Stir halfway through cooking
Lobster (tail)	Frozen	2 pieces, 400 g each	20-22 min.	
Fish fillets	Frozen Fresh	250 g 250 g	10-12 min. 6-8 min.	
Fish steak	Tuna Salmon	250/400 g 250/400 g	10-12 min. 12-14 min.	

CAUTION

When using the juice tray separator, it is recommended to add 1 to 3 minutes to the times shown.

Meat • Poultry

Food	Type	Quantity	Cooking time	Recommendations
Chicken	Boneless fillets	250 g	12 - 15 min.	
	Joints	450 g	30 - 35 min.	
Sausages	Knackwurst	400 g	10 min.	Prick before cooking
	Frankfurters	400 g	15 min.	

Vegetables

Food	Type	Quantity	Cooking time	Recommendations
Artichokes	Fresh	3 medium	45-50 min.	Cut off the base
Asparagus	Fresh	400 g	13-15 min.	Cross over the asparagus stalks to let the steam through
	Frozen (green)	400 g	16-18 min.	
Broccoli	Fresh	400 g	16-18 min.	
	Frozen	400 g	15-18 min.	
Cabbage (quarters)	Fresh	400 g	40-45 min.	
Carrots (sliced)	Fresh	400 g	20-22 min.	Stir half-way through cooking time
Cauliflower	Fresh	400 g	16-18 min.	Stir half-way through cooking time
	Frozen	400 g	18-20 min.	
Brussels Sprouts	Frozen	400 g	20-22 min.	
Mushrooms	Fresh	200 g	12-15 min.	Stir half-way through cooking time
Courgettes (sliced)	Fresh	400 g	16-18 min.	Stir half-way through cooking time
Spinach	Fresh	250 g	8-10 min.	Stir half-way through cooking time
	Frozen	400 g	18-20 min.	
French beans	Fresh	400 g	35-40 min.	Cross beans over to let steam through
	Frozen	400 g	25-28 min.	
Haricot beans	Partly dried	400 g	45-50 min.	Stir half-way through cooking time
Peas	Fresh; (podded)	400 g	10-12 min.	Stir half-way through cooking time
	Frozen	400 g	15-18 min.	
Potatoes	Fresh	10-12 small	20-22 min.	

Times are given as an indication only. They can be varied to suit quantities used and individual tastes.



Rice • Cereals • Pasta

Food	Type	Quantity (glass)	Quantity of water	Cooking time
Rice	White	200 g/2 pers.	300 ml	25 min.
	Brown	300 g/3 pers.	450 ml	35 min.
		200 g/2 pers.	300 ml	35 min.
Couscous grains	Medium grains	150 g/2 pers.	300 ml	5-6 min.
Pasta	Spaghetti	120 g/ 2 pers.	500 ml	18-20 min.

Others foods

Food	Type	Quantity	Cooking time	Recommendations
Eggs	Hard-boiled	6	18 min.	
	Soft-boiled		10 min.	
Apples / Pears	Fresh	4 medium	15-18 min.	

Reheating

Food	Type	Quantity	Reheating time	Recommendations
Meat	Pieces		10-20 min.	
Pasta			10-20 min.	
Vegetables			5-15 min.	

NOTE

Place the food in the rice bowl. To avoid the food getting too moist, cover the top of the rice bowl with a sheet of aluminium foil, so that moisture from the lid goes into the steam bowl and not into the rice bowl.

*This appliance complies with current safety regulations and conditions, and with directives:
Electro-magnetic directive 89/336/EC modified by Directive 93/68/EC
- Low Voltage Directive 72/23/EC modified by Directive 93/68/EC*

Protect the environment

Your appliance is designed for many years use. However, when you decide to replace your appliance, do not forget that you can contribute towards protecting the environ-

ment. The approved service centres will take your worn appliances so as to destroy them in accordance with the environmental rules.

Safety Instructions

- The safety of this appliance complies with technical regulations and standards in force.
 - Check that the voltage of the power supply corresponds to that shown on the appliance (alternating current only).
 - Taking into account the diversity of standards in force, if the appliance is used in a country other than that in which it is purchased, get it checked by an approved service agent.
 - Do not place the appliance near a source of heat: it could be badly damaged. Do not put it into a hot oven.
 - Use a stable work surface, away from water splashes.
 - Never leave the appliance in use without supervision. Keep the appliance out of the reach of children.
 - Do not leave the cord hanging down.
 - Always plug the appliance into an earthed socket.
 - Do not unplug the appliance by pulling on the cord.
 - Always unplug the appliance:
 - immediately after use
 - to move it
 - before cleaning or maintenance.
 - Never immerse the appliance in water !
 - Do not use the appliance if:
 - the appliance or the cord is damaged
 - the appliance has been dropped or fallen and appears damaged or does not work properly.
- In these cases, the appliance must be sent to the nearest approved after-sales Service Centre, since special tools are needed to carry out all repairs.
- If the power supply cable is damaged, it must be replaced by the manufacturer, approved service centre or a similarly qualified person to avoid any danger.
 - Burns may be caused by touching the hot surface of the appliance, the hot water, steam or food.
 - Do not place the appliance near a wall or cupboard. The steam produced may cause damage.
 - To avoid burns, remove the lid gently, keeping away from the inside of the lid and letting the steam escape gradually.
 - Do not touch the appliance when it is producing steam. Use a cloth to remove the lid, rice bowl and steam bowl.
 - Do not touch food inside the steam cooker directly.
 - Do not move the appliance with hot liquid or food inside.
 - This appliance is designed for domestic use only. In the case of professional use, inappropriate use or failure to comply with the instructions, the manufacturer takes no responsibility and the guarantee does not apply.

TEFAL

S.A. SEB SELONGEY CEDEX • RC. DIJON B 302 412 226 • REF. 5060382

CONCEPTION GRAPHIQUE : AVANT PREMIÈRE / RÉALISATION : adhoc.studio@wanadoo.fr